



美特鋁質有限公司

MIDI ALUMINIUM FABRICATOR LTD.



工程指示 / 要求簡箋 ENGINEER INSTRUCTIONS(E.I.)

工程指示編號:	EI- 6006	修改版本:	A
工程編號:	HK- 0913 / 27	工程名稱:	啟德6551
收件人:	Maggie lor	發件人:	nero
工程項目:	後裝趟門 - 繪畫模圖	日期:	02/05/2023

<input type="checkbox"/> 原合約工程包	<input type="checkbox"/> 原合約工程加 / 減賬 QT-	<input type="checkbox"/> 新工程報價 QT-
---------------------------------	--	------------------------------------

信件批核號碼/圖紙參考編號:	批核模具圖紙編號:
客戶指示附件:	管理內部批簽署:

<input type="checkbox"/> 初步鋁料 B.M.	<input type="checkbox"/> 加工拆圖, 然後生產	<input type="checkbox"/> 尺寸表
<input type="checkbox"/> 正式鋁料 B.M.	<input type="checkbox"/> 技術上資料 / 指示	<input type="checkbox"/> 報價
<input type="checkbox"/> 配件 B.M.	<input type="checkbox"/> 樣辦或貨品說明書	<input type="checkbox"/> 分判合約
<input type="checkbox"/> 其他:		

內容: 請按附件資料繪畫以下模號模圖: 1. X86462 及修改以下模號模圖: 1. X86428 2. X86429 3. X86430 4. X86431 5. X86432 6. X86434 7. X86435 8. X86436 9. X86437 10. X86442 11. X86444 12. X86447
完成上列要求日期: 05/05/2023

國內

<input type="checkbox"/> 生產技術總監	<input type="checkbox"/> 連附件	<input type="checkbox"/> 技術部	<input type="checkbox"/> 連附件	<input type="checkbox"/> 生產部	<input type="checkbox"/> 連附件
<input type="checkbox"/> 採購部	<input type="checkbox"/> 連附件	<input type="checkbox"/> 生產統籌部	<input type="checkbox"/> 連附件	<input type="checkbox"/> 報關組	<input type="checkbox"/> 連附件
<input checked="" type="checkbox"/> 質檢部	<input checked="" type="checkbox"/> 連附件	<input type="checkbox"/> 會計部	<input type="checkbox"/> 連附件	<input type="checkbox"/> 機械設計部	<input type="checkbox"/> 連附件
<input type="checkbox"/> 香港辦	<input type="checkbox"/> 連附件	<input type="checkbox"/> 其他:			

香港

<input type="checkbox"/> 行政部	<input type="checkbox"/> 連附件	<input type="checkbox"/> 會計部	<input type="checkbox"/> 連附件	<input type="checkbox"/> 統籌部	<input type="checkbox"/> 連附件	<input type="checkbox"/> 工程部	<input type="checkbox"/> 連附件
<input checked="" type="checkbox"/> 採購部	<input checked="" type="checkbox"/> 連附件	<input type="checkbox"/> QS部	<input type="checkbox"/> 連附件	<input type="checkbox"/> 地盤管理	<input type="checkbox"/> 連附件	<input type="checkbox"/> 維修部	<input type="checkbox"/> 連附件

*發件人簽署:	*組別成員批核簽署:
傳遞編號: HK-0913/23	項目經理簽署:

 MIDI ALUMINIUM FABRICATOR LTD.	DRAWING NO. X86462	REV. -	TITLE -
--	------------------------------	------------------	-------------------

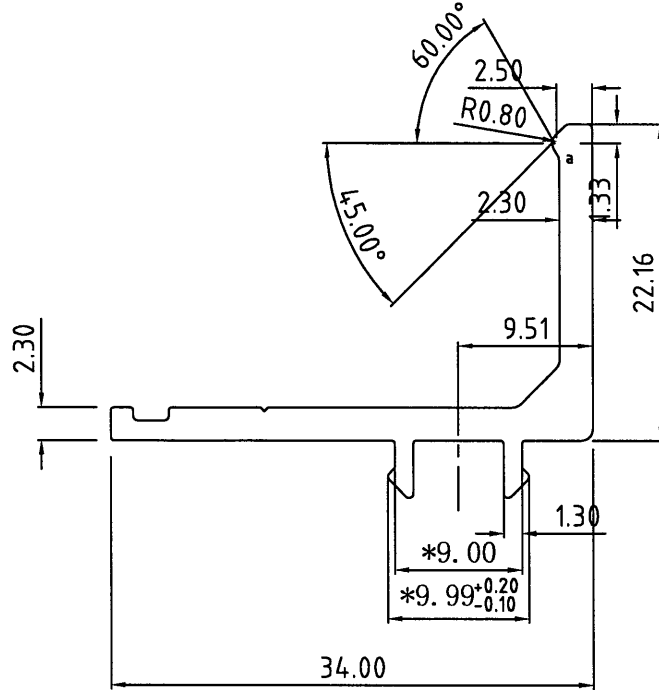

美特鋁質有限公司	
承認圖面	
日期	2/5-2023

a=R0.4
b=R0.5

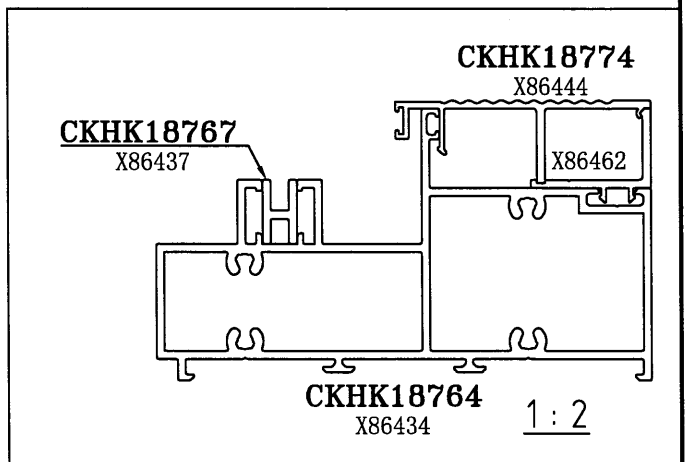

APPROVED :

6063-T5

SECTIONAL AREA mm ² 136.8	ADDITIONAL TOLERANCE Thickness ± 0.1 mm	DATE 24/02/2023	REVISION			
WEIGHT KG/M 0.37	Flatness 0.1 /25mm width	SCALE 1 : 1	NO.	DATE	NAME	DESCRIPTION
PERIMETER mm 126.5	Straightness 0.3 /300mm	DRAWN -				
V.F. mm 114	Twist 0.5° /300 mm max Angularity ± 1.0 degree	CHECK				

	DRAWING NO. X86428	REV.	TITLE -
--	-----------------------	------	------------

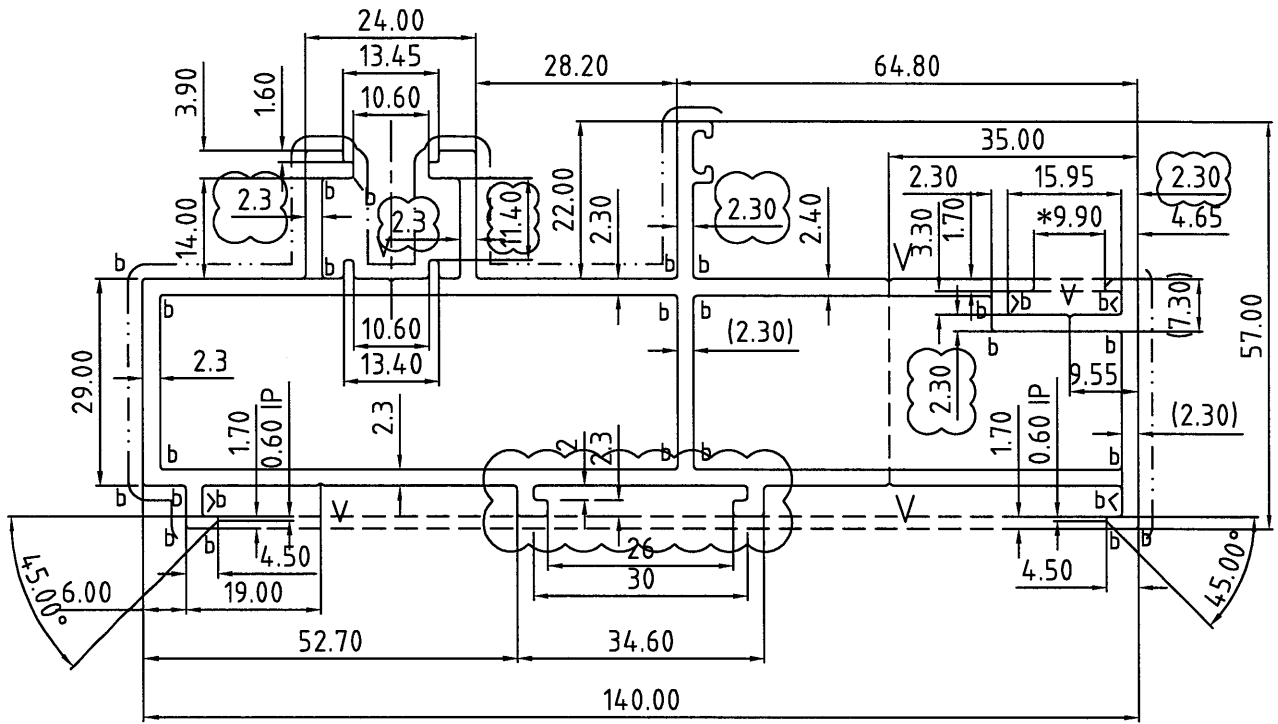

SCALE 1:1

美特鋁質有限公司	
承認圖面	
日期	2/5-2023

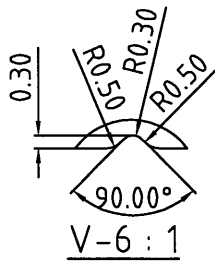
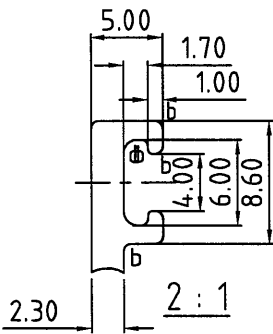

a=R0.4
b=R0.5

APPROVED :

6063-T6

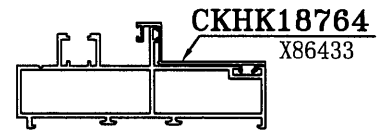

CKHK18758
X86428

1:4

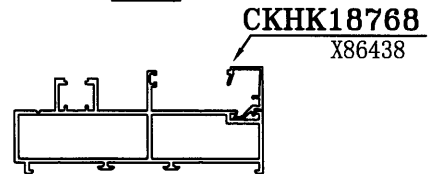

CKHK18758
X86428

1:4

SECTIONAL AREA	mm ²	ADDITIONAL TOLERANCE	DATE	REVISION			
				NO.	DATE	NAME	DESCRIPTION
1079.642		Thickness ± 0.1 mm	24/02/2023				
WEIGHT	KG/M	Flatness 0.1 /25mm width	SCALE				
2.92		Straightness 0.3 /300mm	1 : 1				
PERIMETER	mm	Twist 0.5° /300 mm max	DRAWN				
561		Angularity ± 1.0 degree	-				
V.F.	mm		CHECK				
211							

 MIDI ALUMINIUM FABRICATOR LTD.	DRAWING NO. X86429	REV.	TITLE -
--	---------------------------	------	------------

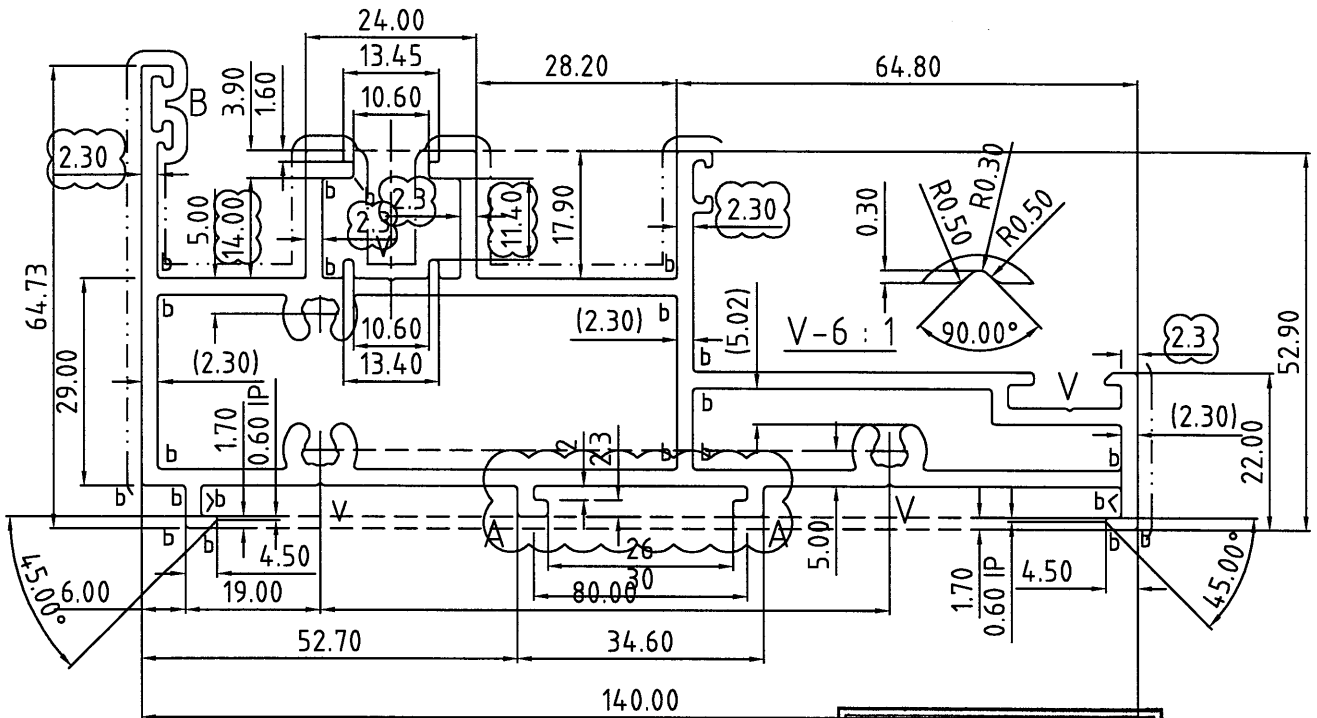

美特鋁質有限公司

承認圖面	
日期	2/9-2023

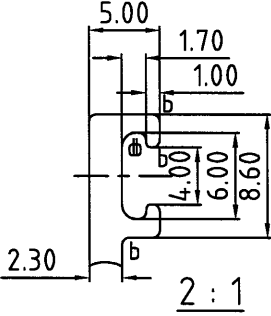
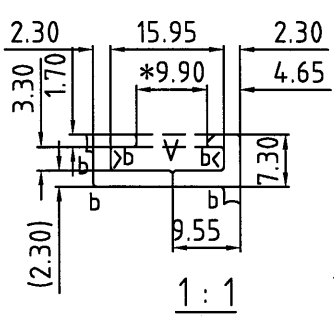
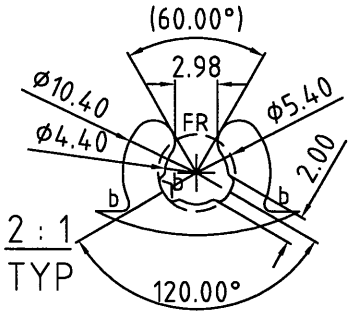
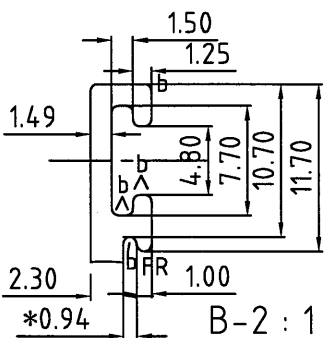

a=R0.4
b=R0.5

APPROVED :

6063-T6

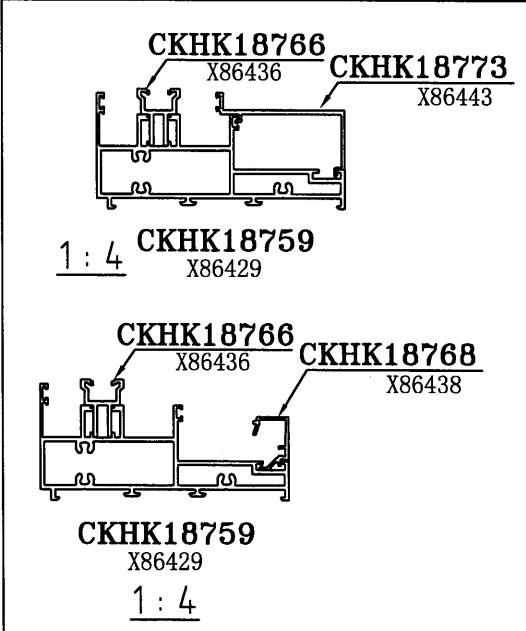

SECTIONAL AREA	mm ²	1222.89	ADDITIONAL TOLERANCE	DATE	REVISION																
WEIGHT	KG/M	3.31	Thickness ± 0.1 mm	24/02/2023	<table border="1" style="width: 100%;"> <thead> <tr> <th>NO.</th> <th>DATE</th> <th>NAME</th> <th>DESCRIPTION</th> </tr> </thead> <tbody> <tr><td> </td><td> </td><td> </td><td> </td></tr> <tr><td> </td><td> </td><td> </td><td> </td></tr> <tr><td> </td><td> </td><td> </td><td> </td></tr> </tbody> </table>	NO.	DATE	NAME	DESCRIPTION												
NO.	DATE	NAME	DESCRIPTION																		
PERIMETER	mm	626	Flatness 0.1 /25mm width	SCALE																	
V.F.	mm	188	Straightness 0.3 /300mm	1 : 1																	
			Twist 0.5° /300 mm max	DRAWN																	
			Angularity ± 1.0 degree	CHECK																	

	DRAWING NO.	REV.	TITLE
	X86430		-

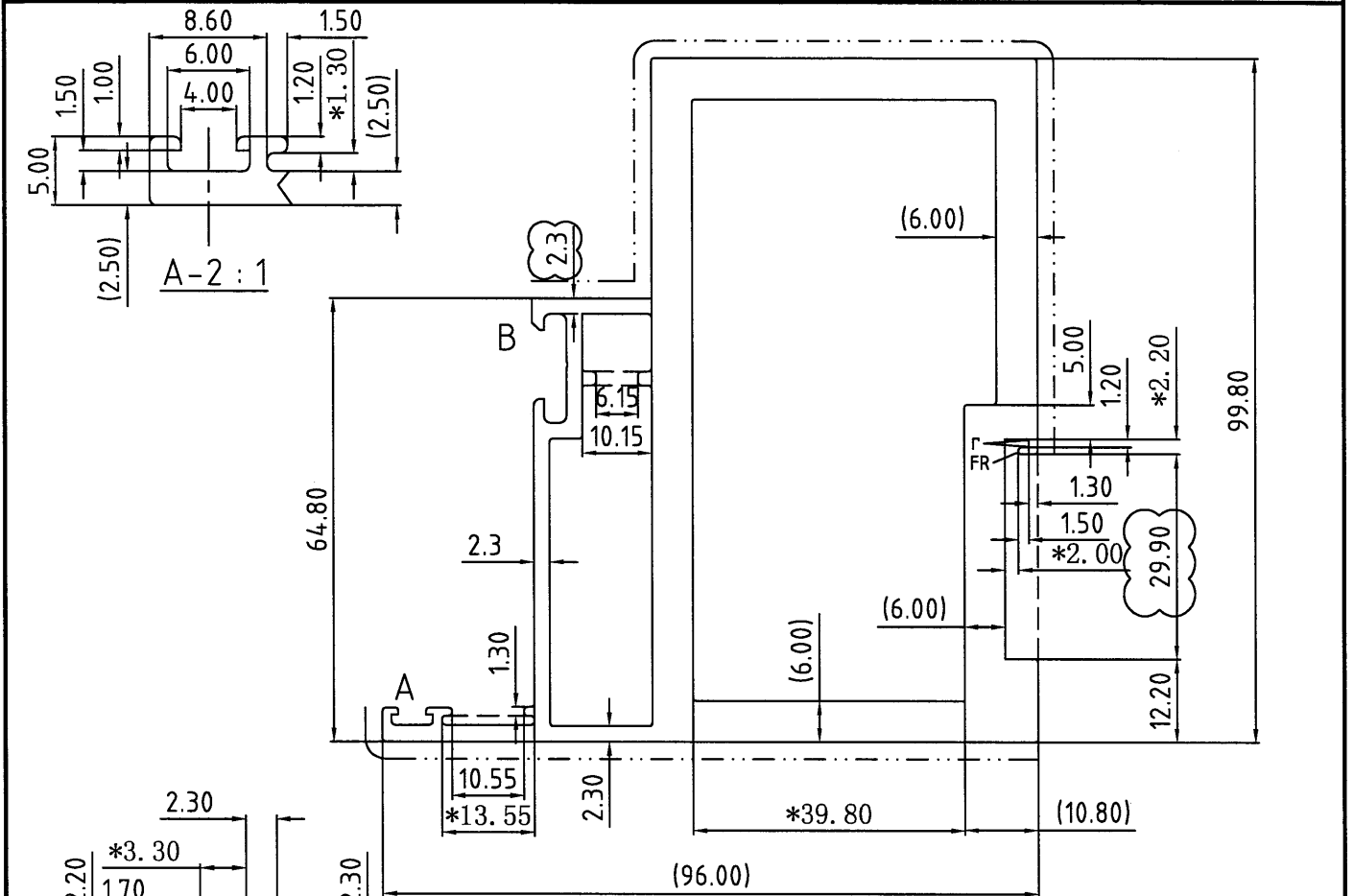

SCALE 1:1

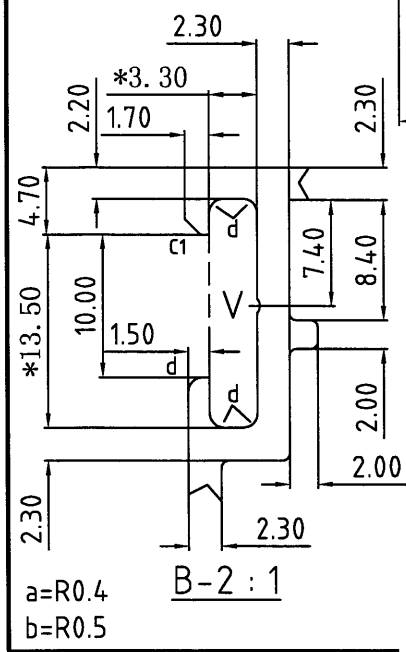

美特鋁質有限公司
承認圖面
日期 2/5-2023

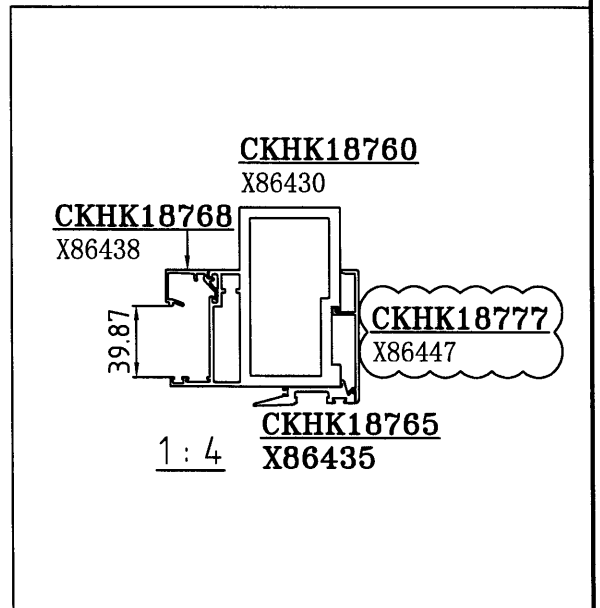

APPROVED :

6063-T6

SECTIONAL AREA	mm ²	2104.7	ADDITIONAL TOLERANCE	DATE	REVISION			
WEIGHT	KG/M	5.70	Thickness ± 0.1 mm	24/02/2023	NO.	DATE	NAME	DESCRIPTION
PERIMETER	mm	443	Flatness 0.1 /25mm width	SCALE 1 : 1				
V.F.	mm	280	Straightness 0.3 /300mm	DRAWN -				
			Twist 0.5° /300 mm max	CHECK				
			Angularity ± 1.0 degree					

 MIDI ALUMINIUM FABRICATOR LTD.	DRAWING NO. X86431	REV.	TITLE -
--	------------------------------	------	------------

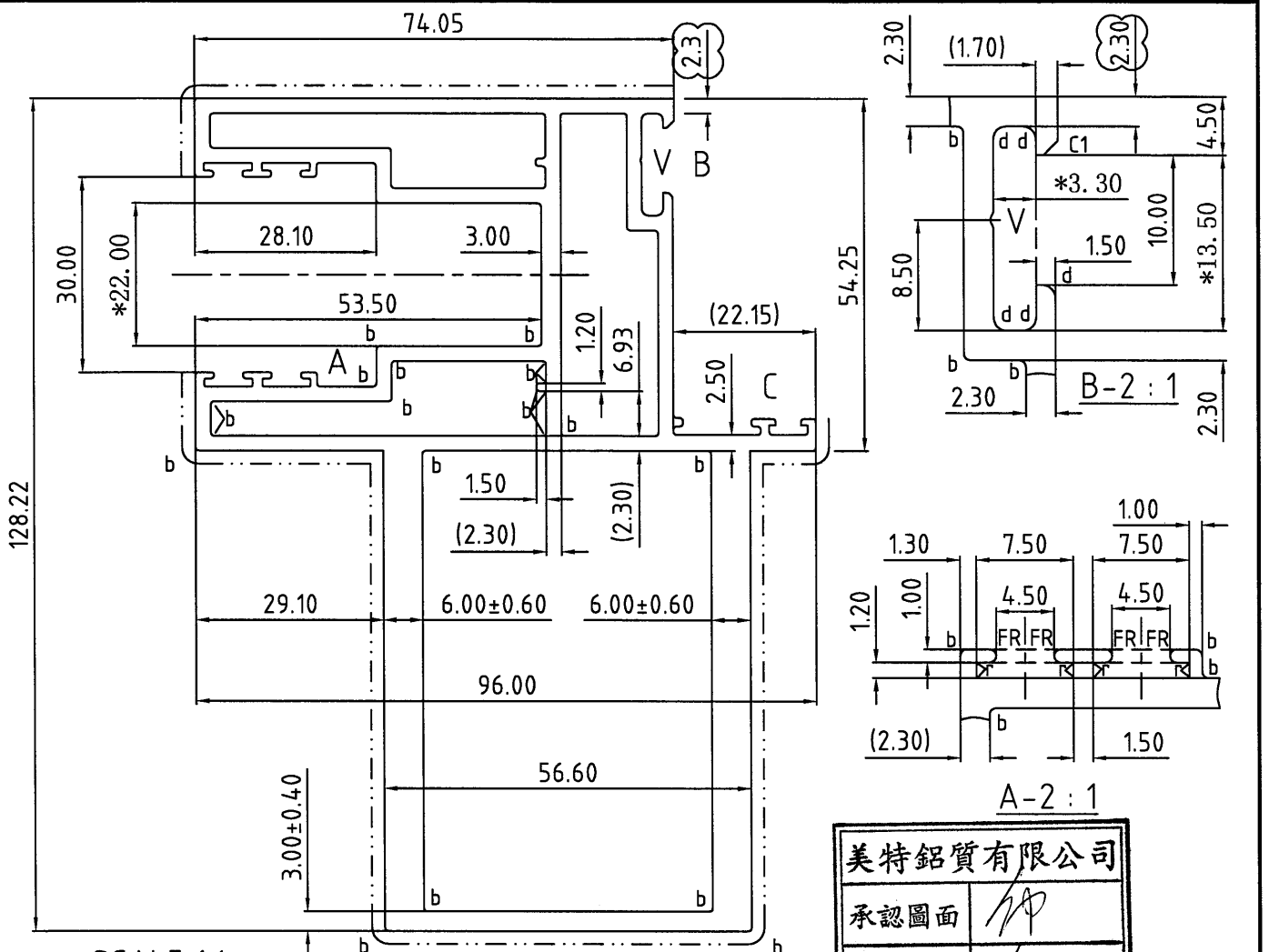

SCALE 1:1

美特鋁質有限公司
 承認圖面 *[Signature]*
 日期 *2/5-2023*

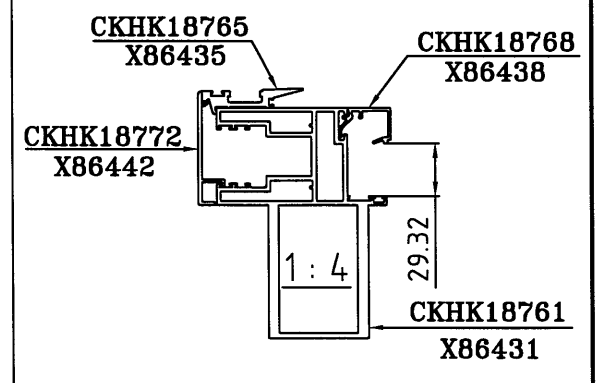
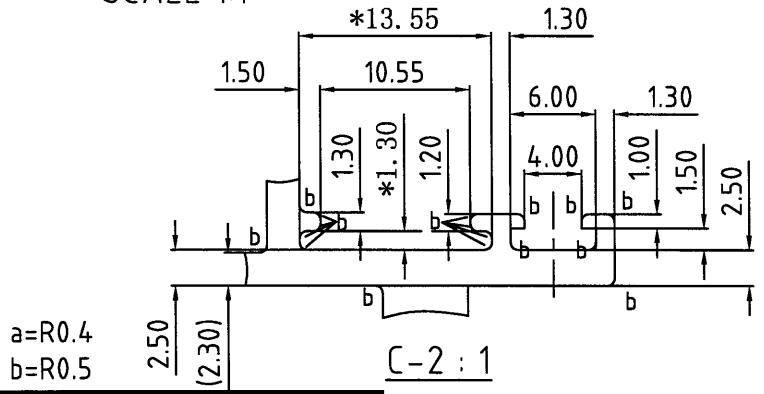

APPROVED :

6063-T6

SECTIONAL AREA	mm ²	2027.44	ADDITIONAL TOLERANCE	Thickness	± 0.1 mm	DATE	24/02/2023	REVISION			
	WEIGHT	KG/M		5.49	Flatness		0.1 /25mm width	SCALE	1 : 1	NO.	DATE
PERIMETER	mm	633	Straightness	0.3 /300mm	DRAWN	-					
V.F.	mm	293	Twist	0.5° /300 mm max	CHECK	-					
			Angularity	± 1.0 degree							

	DRAWING NO.	REV.	TITLE
	X86432		-

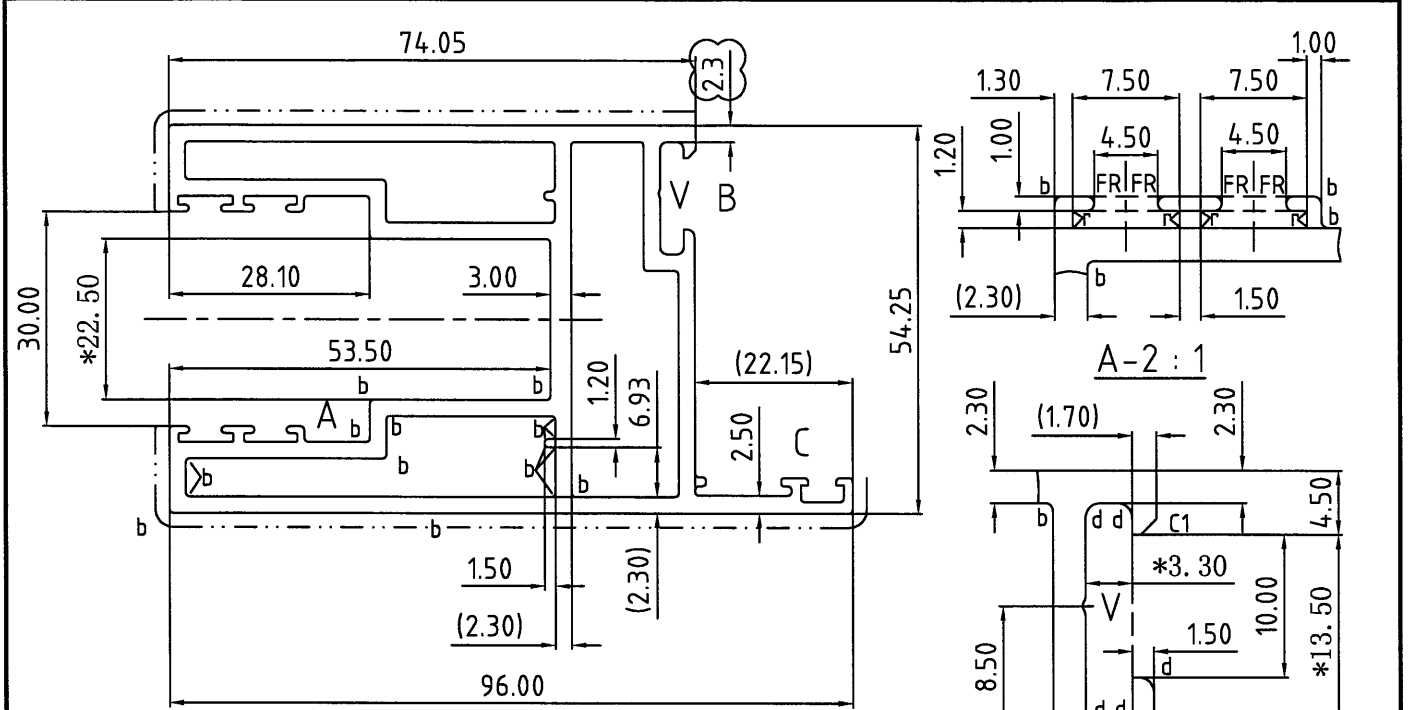

SCALE 1:1

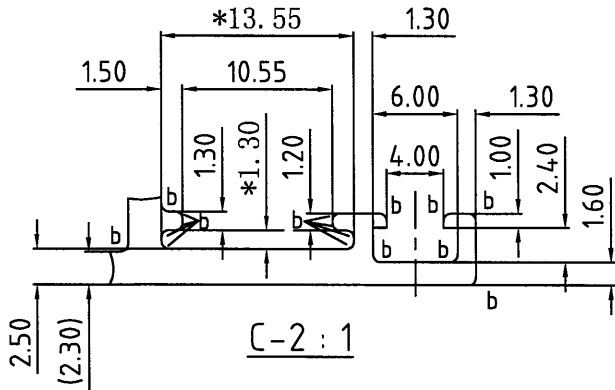

C-2:1

美特鋁質有限公司	
承認圖面	<i>[Signature]</i>
日期	2/5-2023

a=R0.4
b=R0.5

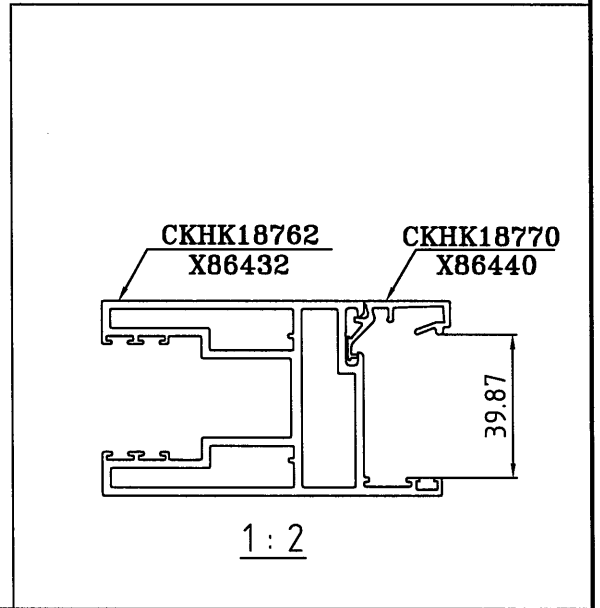

1:2

APPROVED :

6063-T6

SECTIONAL AREA	mm ²	999.72	ADDITIONAL TOLERANCE	DATE	REVISION			
WEIGHT	KG/M	2.7	Thickness ± 0.1 mm	24/02/2023	NO.	DATE	NAME	DESCRIPTION
PERIMETER	mm	487.36	Flatness 0.1 /25mm width	SCALE				
V.F.	mm	218	Straightness 0.3 /300mm	1 : 1				
			Twist 0.5° /300 mm max	DRAWN				
			Angularity ± 1.0 degree	CHECK				

 MIDI ALUMINIUM FABRICATOR LTD.	DRAWING NO. X86435	REV. -	TITLE -
--	------------------------------	------------------	-------------------

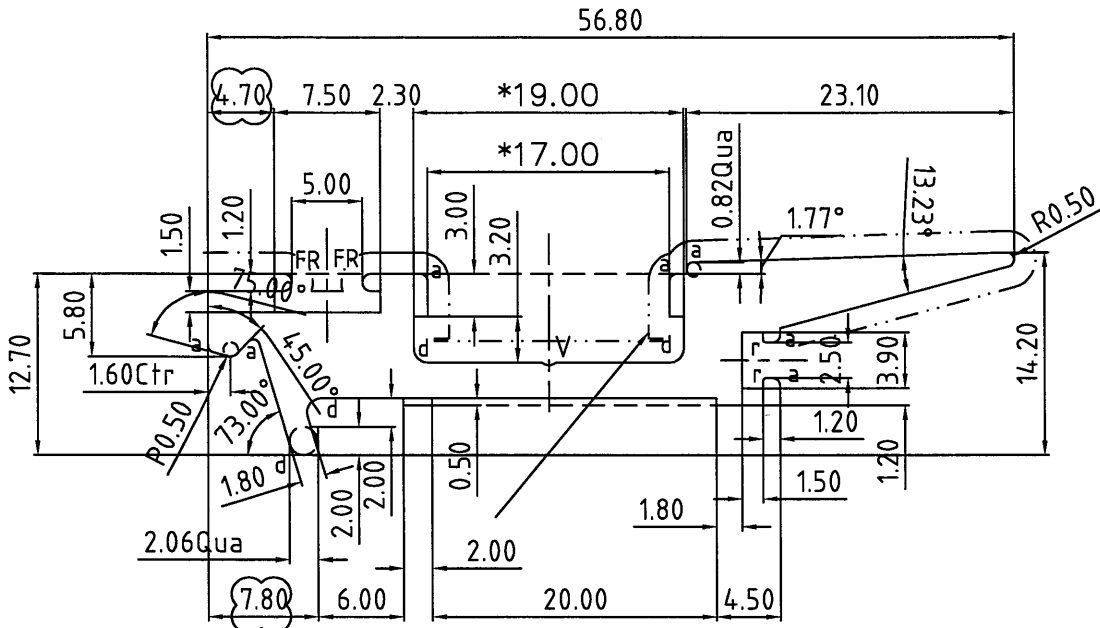

SCALE 2:1

美特鋁質有限公司	
承認圖面	
日期	2/5-2023

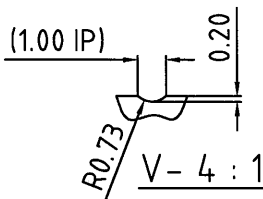

a=R0.4
b=R0.5

APPROVED :

6063-T6

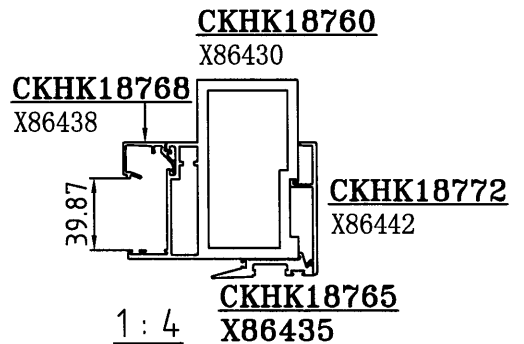

SECTIONAL AREA mm ² 262.46	ADDITIONAL TOLERANCE Thickness ± 0.1 mm	DATE 24/02/2023	REVISION			
WEIGHT KG/M 0.712	Flatness 0.1 /25mm width	SCALE 1 : 1	NO.	DATE	NAME	DESCRIPTION
PERIMETER mm 170.83	Straightness 0.3 /300mm	DRAWN -				
V.F. mm 80	Twist 0.5° /300 mm max Angularity ± 1.0 degree	CHECK				

 MIDI ALUMINIUM FABRICATOR LTD.	DRAWING NO. X86436	REV. -	TITLE -
--	------------------------------	------------------	-------------------

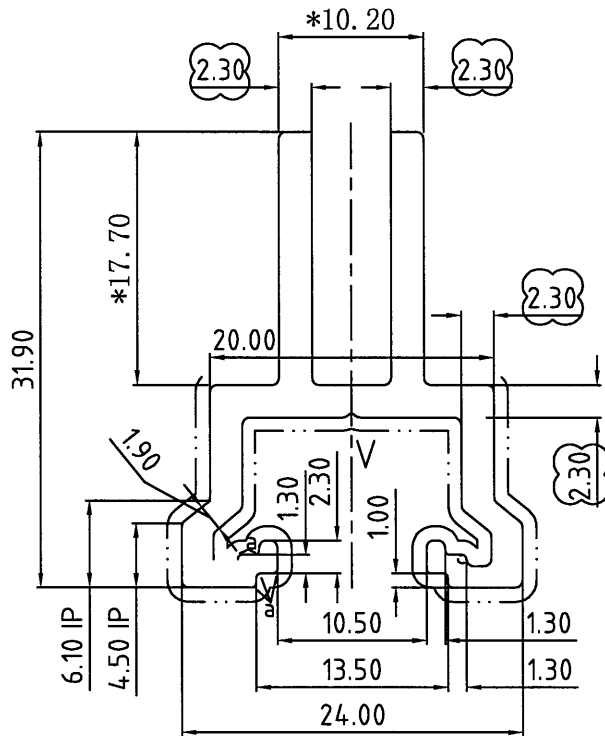

SCALE 2:1

美特鋁質有限公司	
承認圖面	<i>仲</i>
日期	2/5-2023

a=R0.4
b=R0.5

APPROVED :

6063-T6

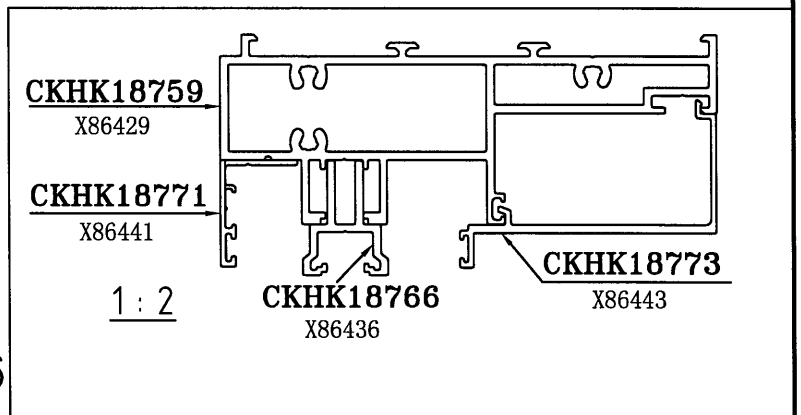

SECTIONAL AREA	mm ²	202	ADDITIONAL TOLERANCE		DATE	REVISION				
			Thickness	± 0.1	mm	24/02/2023	NO.	DATE	NAME	DESCRIPTION
WEIGHT	KG/M	0.547	Flatness	0.1	/25mm width	SCALE				
			Straightness	0.3	/300mm	1 : 1				
PERIMETER	mm	184.16	Twist	0.5°	/300 mm max	DRAWN				
			Angularity	± 1.0	degree	-				
V.F.	mm	62				CHECK				

	DRAWING NO.	REV.	TITLE
	X86437		-

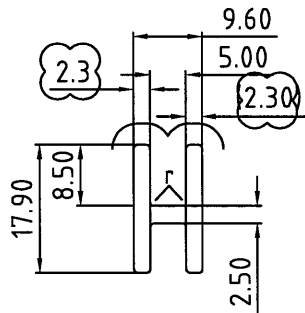

SCALE 1:1

美特鋁質有限公司	
承認圖面	<i>[Signature]</i>
日期	2/5-2023

a=R0.4
b=R0.5

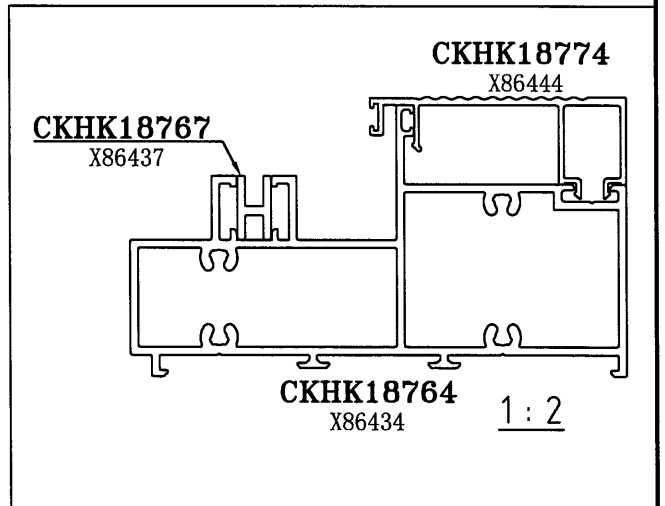

APPROVED :

6063-T6

SECTIONAL AREA	mm ²	95	ADDITIONAL TOLERANCE	DATE	REVISION			
			Thickness ± 0.1 mm	24/02/2023	NO.	DATE	NAME	DESCRIPTION
WEIGHT	KG/M	0.257	Flatness 0.1 /25mm width	SCALE				
				1 : 1				
PERIMETER	mm	83.9	Straightness 0.3 /300mm	DRAWN				
				-				
V.F.	mm	10	Twist 0.5° /300 mm max	CHECK				
			Angularity ± 1.0 degree					

 MIDI ALUMINIUM FABRICATOR LTD.	DRAWING NO. X86442	REV. -	TITLE -
--	------------------------------	------------------	-------------------

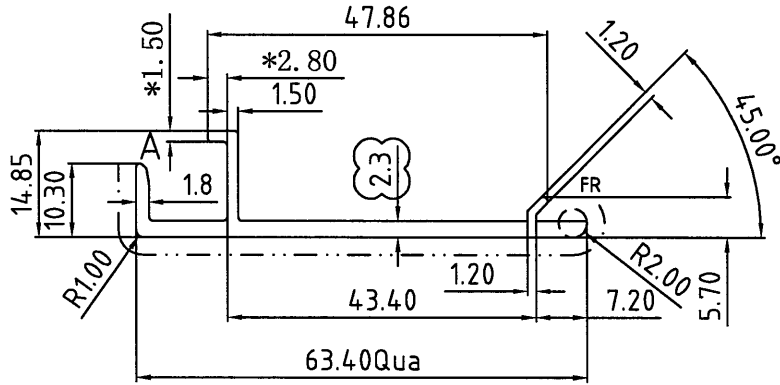

SCALE 1:1

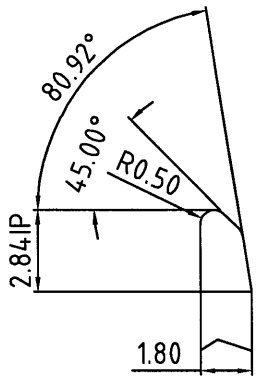

A-4 : 1

a=R0.4
b=R0.5

美特鋁質有限公司	
承認圖面	
日期	2/5 2023

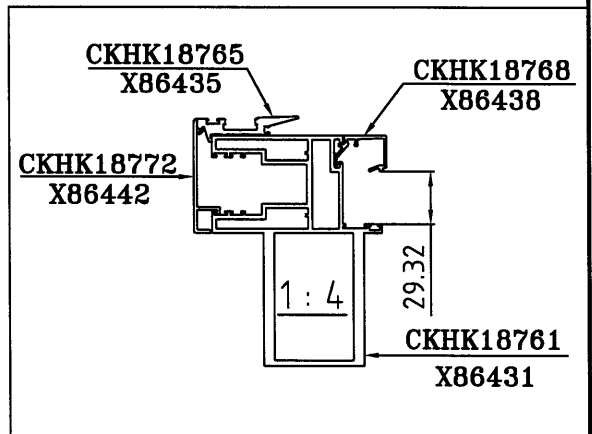

APPROVED :

6063-T5

SECTIONAL AREA	mm ²	ADDITIONAL TOLERANCE	DATE	REVISION			
				NO.	DATE	NAME	DESCRIPTION
186		Thickness ± 0.1 mm	24/02/2023				
WEIGHT	KG/M	Flatness 0.1 /25mm width	SCALE				
0.5		Straightness 0.3 /300mm	1 : 1				
PERIMETER	mm	Twist 0.5° /300 mm max	DRAWN				
181		Angularity ± 1.0 degree	-				
V.F.	mm		CHECK				
85							

 MIDI ALUMINIUM FABRICATOR LTD.	DRAWING NO. X86444	REV.	TITLE -
--	------------------------------	------	------------

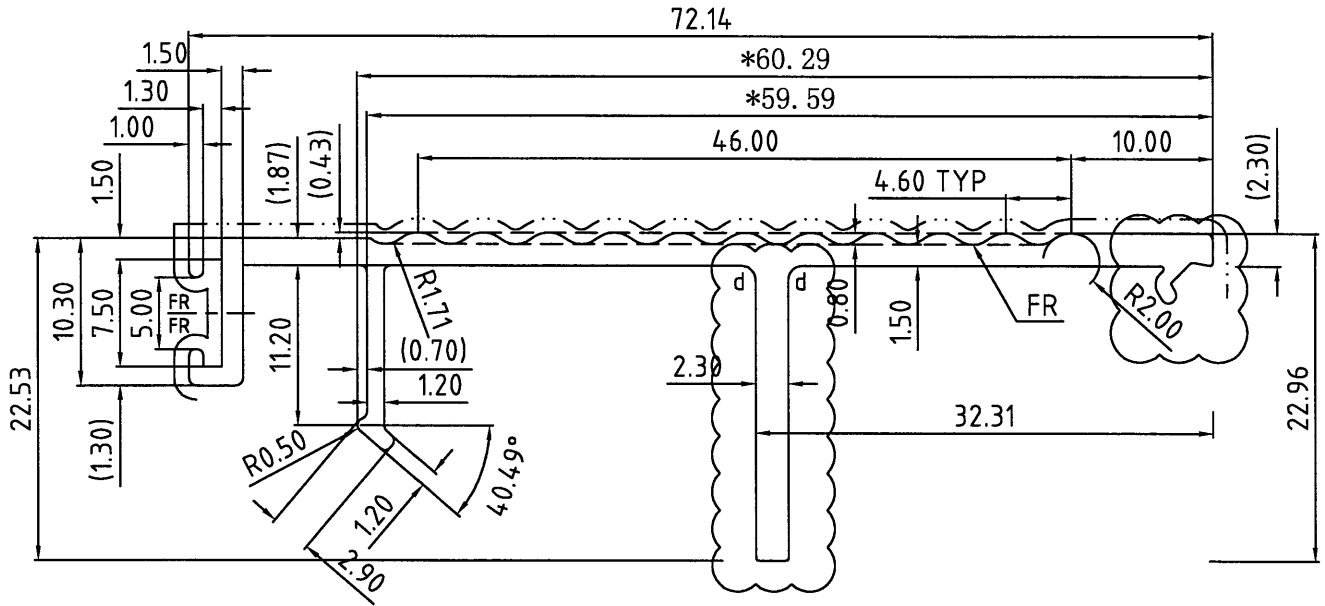

美特鋁質有限公司	
承認圖面	印
日期	2/5-2023

a=R0.4
b=R0.5

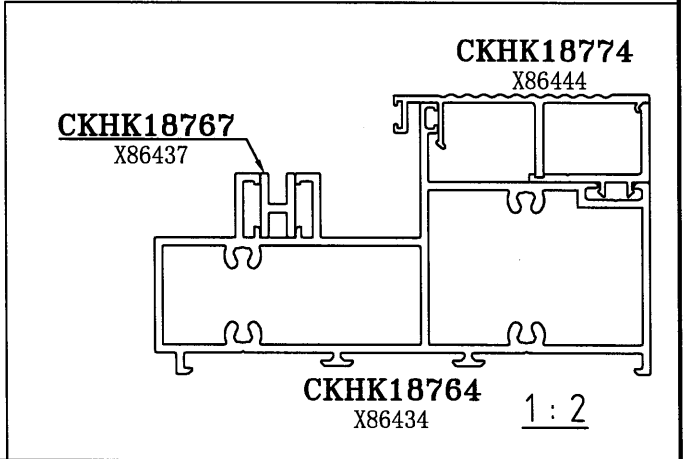

APPROVED :

6063-T5

SECTIONAL AREA	mm ²	ADDITIONAL TOLERANCE		DATE	REVISION				
		225	Thickness	± 0.1	mm	24/02/2023	NO.	DATE	NAME
WEIGHT	KG/M	0.6	Flatness	0.1 /25mm width	SCALE				
			1 : 1						
PERIMETER	mm	248	Straightness	0.3 /300mm	DRAWN				
			-						
V.F.	mm	114	Twist	0.5° /300 mm max	CHECK				
			Angularity	± 1.0 degree					

 MIDI ALUMINIUM FABRICATOR LTD.	DRAWING NO. X86447	REV. -	TITLE -
--	------------------------------	------------------	-------------------

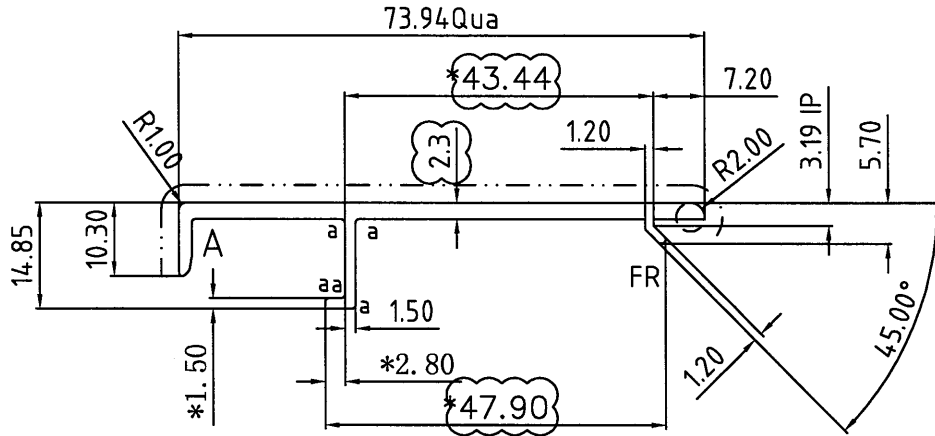

SCALE 1:1

美特鋁質有限公司	
承認圖面	
日期	2/9-2023

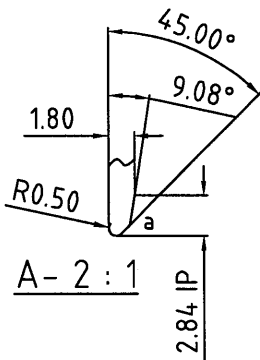

a=R0.4
b=R0.5

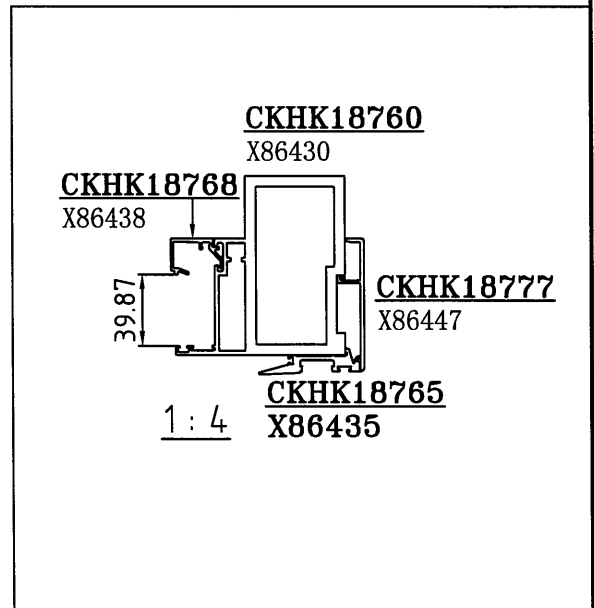

APPROVED :

6063-T5

SECTIONAL AREA	mm ²	ADDITIONAL TOLERANCE	DATE	REVISION			
				NO.	DATE	NAME	DESCRIPTION
210		Thickness ± 0.1 mm	24/02/2023				
WEIGHT	KG/M	Flatness 0.1 /25mm width	SCALE				
0.57		Straightness 0.3 /300mm	1 : 1				
PERIMETER	mm	Twist 0.5° /300 mm max	DRAWN				
203		Angularity ± 1.0 degree	-				
V.F.	mm		CHECK				
85							