

工程指示 / 要求簡箋(E.I.)

工程指示編號：EI / 9192 / 25

修改版次：

工程編號：J - 858

工程名稱：將軍澳日出康城 11

工程項目：T1 & T3 特色層鋁板口後加鋁板 7 件

收件人：生統

發件人：Jason Leung

日期：31/10/2025

要求提供 / 確認 事項：

- | | | |
|------------------------------------|-------------------------------------|-------------------------------|
| <input type="checkbox"/> 初步鋁料 B.M. | <input type="checkbox"/> 加工拆圖，然後生產 | <input type="checkbox"/> 尺寸表 |
| <input type="checkbox"/> 正式鋁料 B.M. | <input type="checkbox"/> 技術上資料 / 指示 | <input type="checkbox"/> 報價 |
| <input type="checkbox"/> 配件 B.M. | <input type="checkbox"/> 樣辦或貨品說明書 | <input type="checkbox"/> 分判合約 |
- 內容：

請生產 T1 62 BA 鵝頭收口鋁板 (編號 AQ-323A 一件, AQ-324A 一件 AQ-327A 一件)

T3 R/F AE 鵝頭封篤收口鋁板 ((編號 AQ-312A 一件)

T3 67/F BD 鵝頭封篤收口鋁板 ((編號 AQ-204A 一件)

T3 67/F BC 鵝頭封篤收口鋁板 ((編號 AQ-202A 一件)

T3 67/F BB 鋁板牆,企身收口鋁板 ((編號 AQ-120.1 一件)

由於加快送地盤，鋁板廠不用噴塗，由地盤現場噴，需打磨後出貨

請在 2025.11.14 前完成上列要求。

附： 頁

原合約工程包

原合約工程加 / 減賬

新工程報價

分發東莞各部門：

- | | | | |
|--|---|--|--|
| <input type="checkbox"/> 生產技術總監 <input type="checkbox"/> 連附件 | <input checked="" type="checkbox"/> 技術部 <input checked="" type="checkbox"/> 連附件 | <input type="checkbox"/> 生產部 <input type="checkbox"/> 連附件 | <input type="checkbox"/> 機械設計部 <input type="checkbox"/> 連附件 |
| <input type="checkbox"/> 採購部 <input type="checkbox"/> 連附件 | <input checked="" type="checkbox"/> 生產統籌部 <input checked="" type="checkbox"/> 連附件 | <input checked="" type="checkbox"/> 小羅&清 <input checked="" type="checkbox"/> 連附件 | |
| <input type="checkbox"/> 質檢部 <input type="checkbox"/> 連附件 | <input type="checkbox"/> 會計部 <input type="checkbox"/> 連附件 | <input type="checkbox"/> 報關組 <input type="checkbox"/> 連附件 | <input type="checkbox"/> 其他 _____ <input type="checkbox"/> 連附件 |

分發香港各部門：

- | | | | |
|---|--|---|--|
| <input type="checkbox"/> 行政部 <input type="checkbox"/> 連附件 | <input type="checkbox"/> 會計部 <input type="checkbox"/> 連附件 | <input type="checkbox"/> 統籌部 <input type="checkbox"/> 連附件 | <input type="checkbox"/> 工程部地盤科文 <input type="checkbox"/> 連附件 |
| <input type="checkbox"/> 採購部 <input type="checkbox"/> 連附件 | <input type="checkbox"/> QS 部 <input type="checkbox"/> 連附件 | <input type="checkbox"/> 維修部 <input type="checkbox"/> 連附件 | <input type="checkbox"/> 其他 _____ <input type="checkbox"/> 連附件 |

傳遞編號：

HK 0857 / 25

發件人簽署：

項目經理簽署：

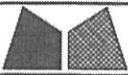

美特铝质有限公司
MIDI Aluminium Fabricator Ltd.

工程號	J858	類別		物料號	-		
地盘	康城11期	制圖	J.L.	2023-08-01	圖號	AQ-323	
修改	A	採用工廠	地盘	✓	图纸名称	铝板加工图	
日期	05/03	材料颜色	香槟金 (E03X10093S-JF2)	材料	3mm THK. 铝板	復核	-
						批准	-
						數量	-
						單件重量	- (KG)

编号	L	N
AQ-323A	1870	Ø300c/cx5

TI 62BA

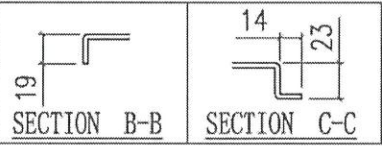
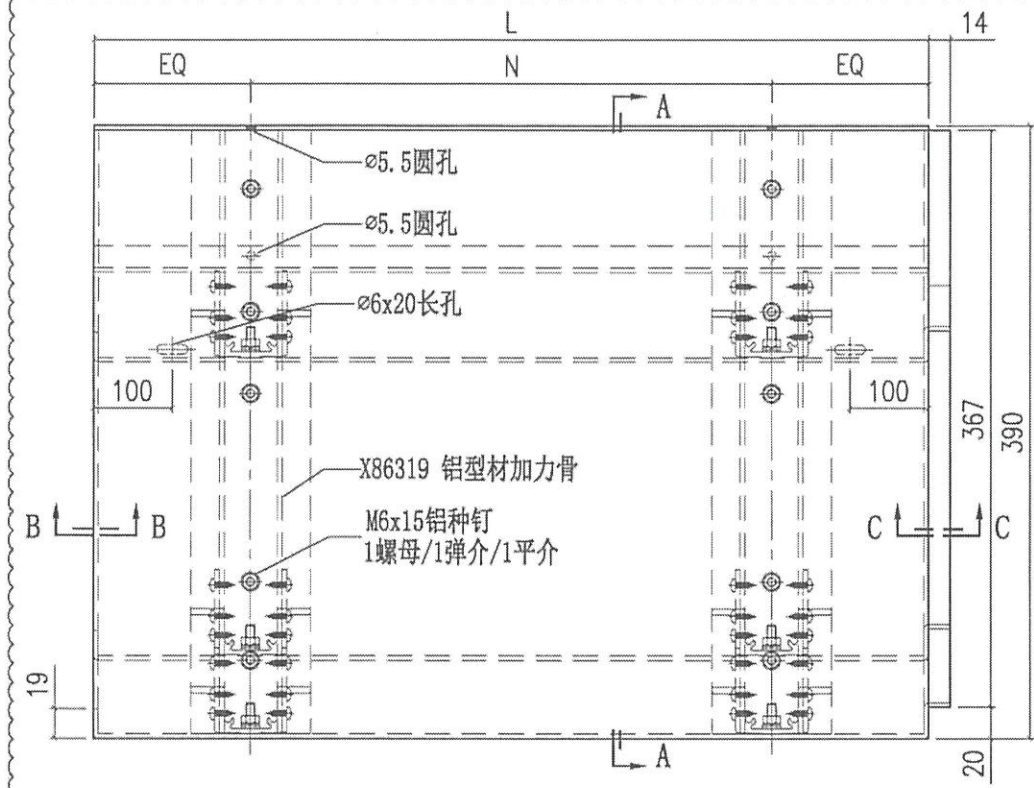

D90a

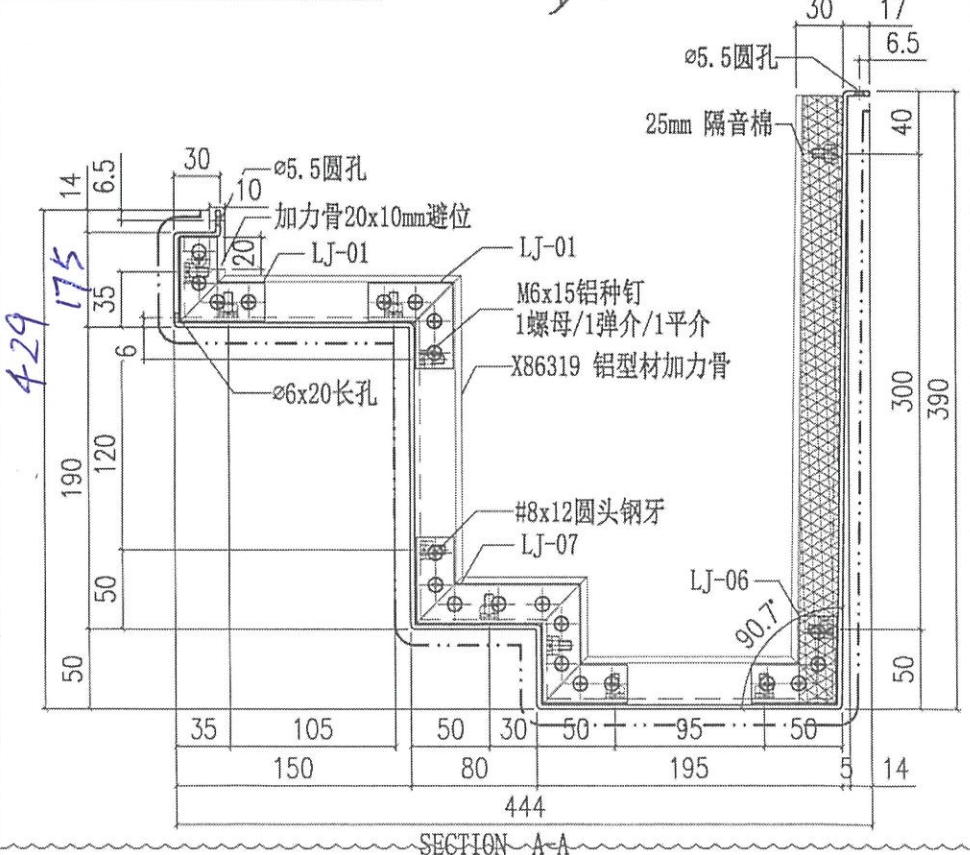
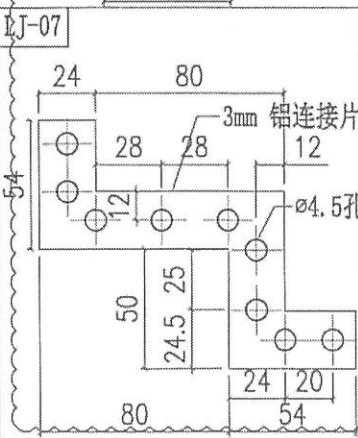
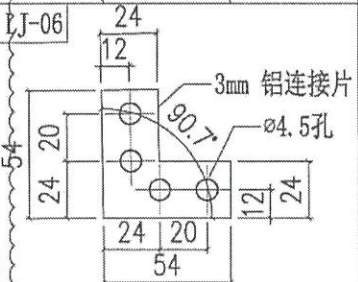



美特铝质有限公司
MIDI Aluminium Fabricator Ltd.

工程號	J858	類別		物料號	-
地盘	康城11期	制圖	J.L.	2023-08-01	圖號 AQ-324
修改 A	採用工廠	地盘	✓	图纸名称	铝板加工图
日期 05/03	材料颜色	香槟金 (E203X1009S-JF2)	材料	3mm THK. 铝板	復核 -
					批准 -
					數量 -
					單件重量 - (KG)

编号	L	N
AQ-324A	525	300

TI 62BA

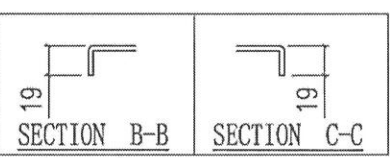
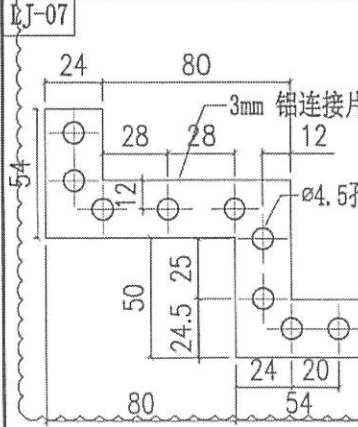
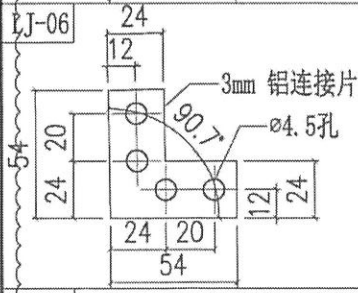
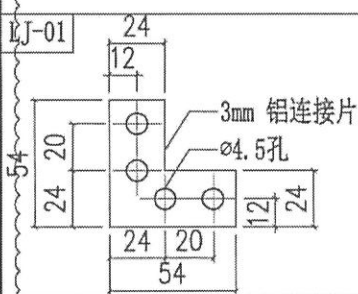
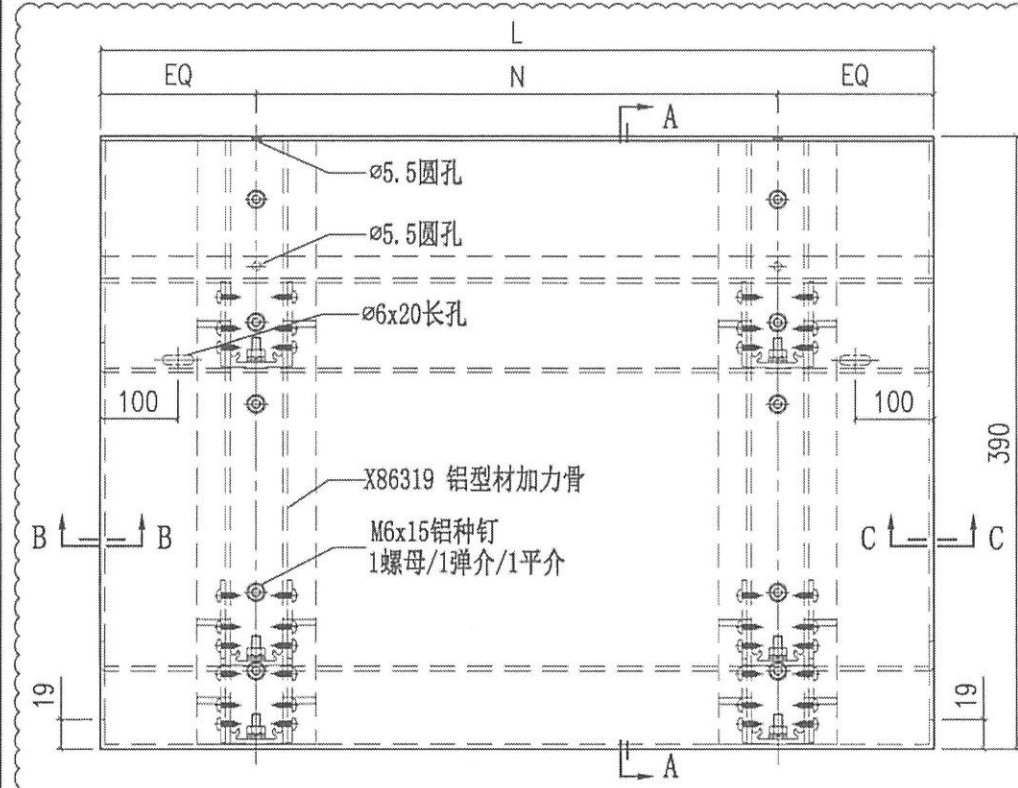

D90a

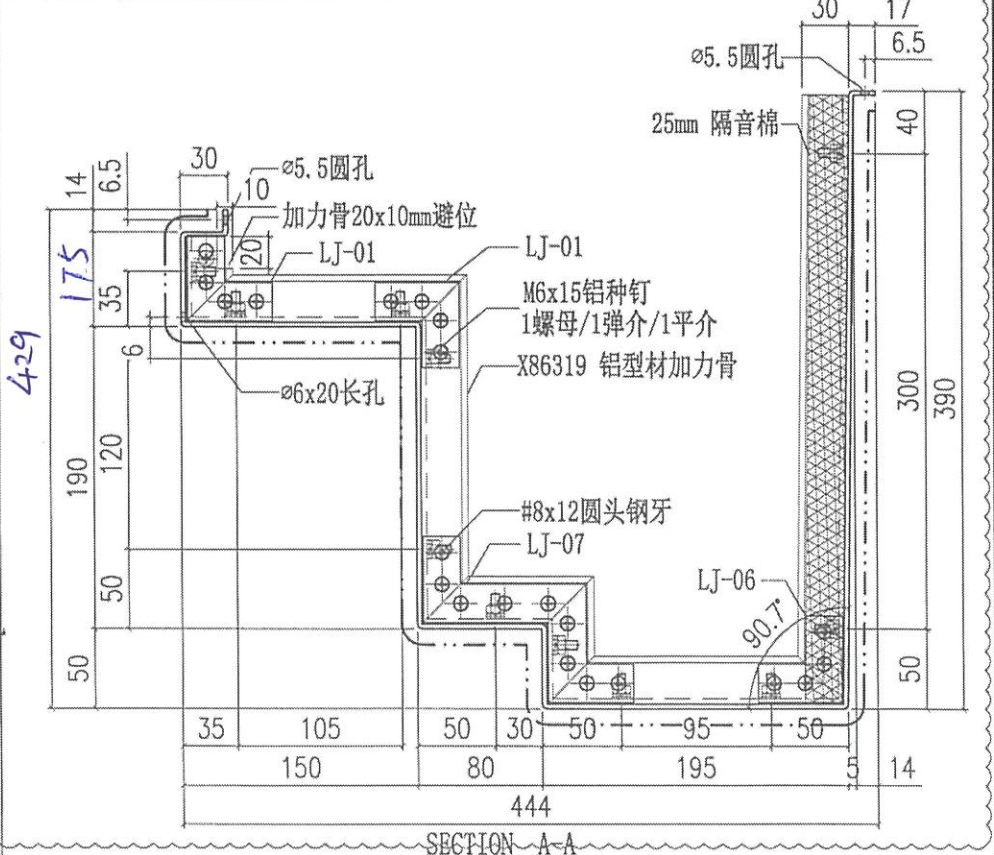



美特鋁質有限公司
MIDI Aluminium Fabricator Ltd.

工程號	J858	類別		物料號	-				
地盘	康城11期	制圖	J.L.	2023-08-01	圖號	AQ-327			
修改	A	採用工廠	✓	圖紙名稱	铝板加工图	復核	-	數量	-
日期	05/03	材料颜色	香槟金 (EC03X10099S-JF2)	材料	3mm THK. 铝板	批准	-	單件重量	- (KG)

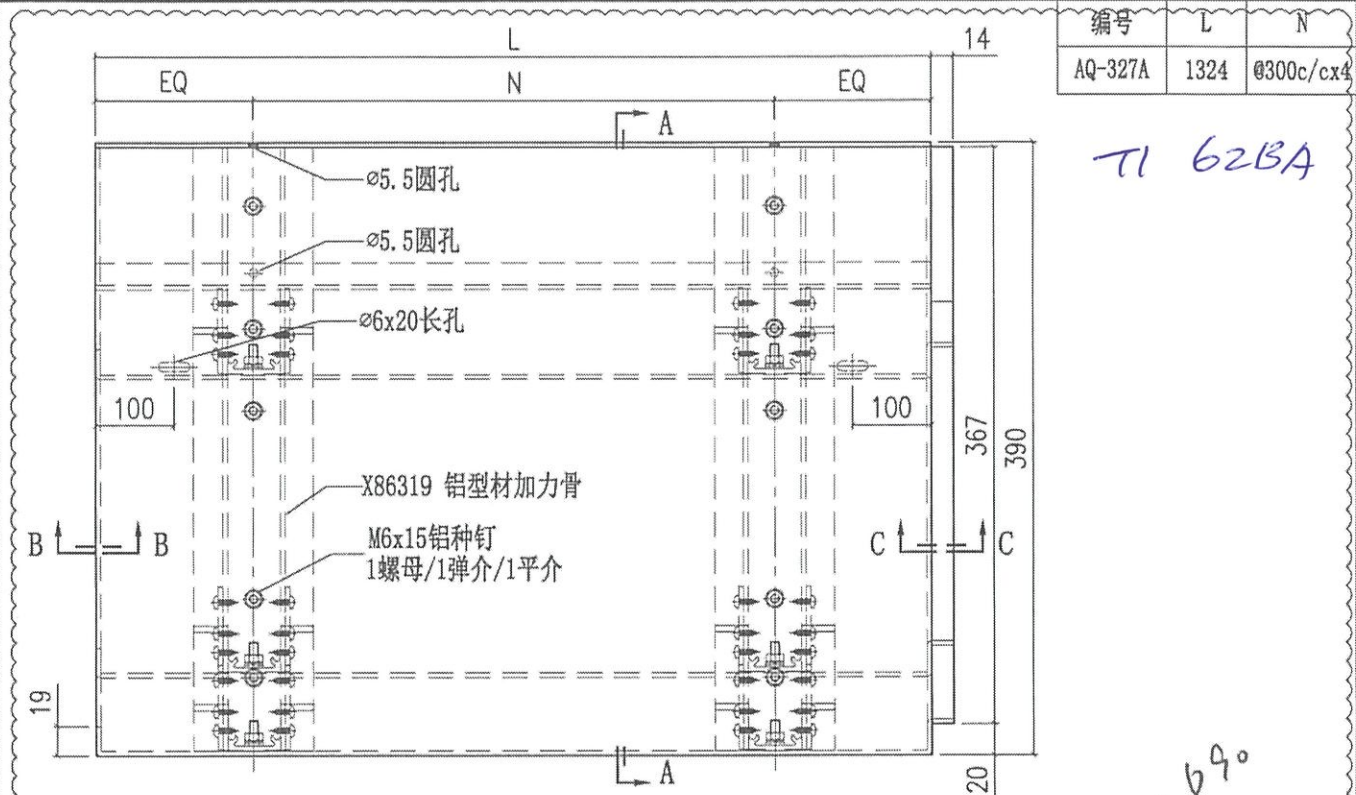

编号	L	N
AQ-327A	1324	Ø300c/cx4

TI 62BA

$90^\circ = 69^\circ$

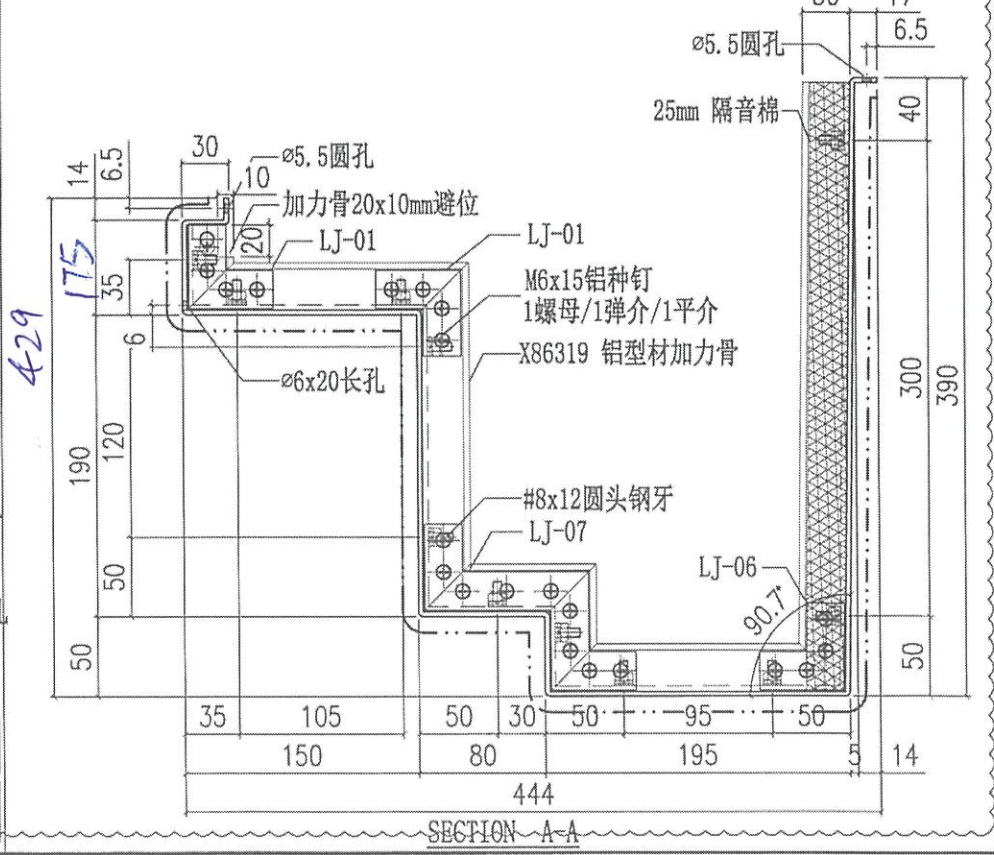
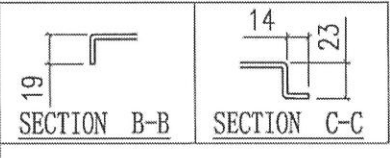
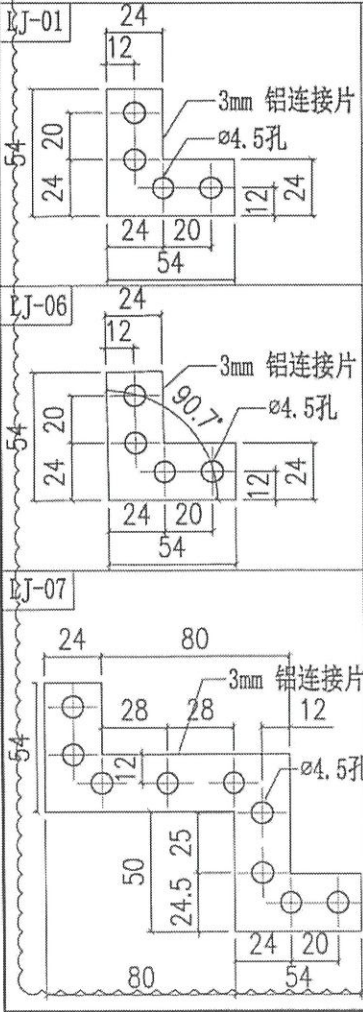

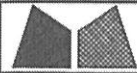

美特铝质有限公司
MIDI Aluminium Fabricator Ltd.

工程號	J858	類別		物料號	-				
地盘	康城11期	制圖	J.L.	2023-08-01	圖號	AQ-312			
修改	A B	採用工廠		圖紙名稱	铝板加工图	復核	-	數量	-
日期	05/10 05/03	材料颜色	香槟金(E023X10099S-JP2)	材料	3mm THK. 铝板	批准	-	單件重量	- (KG)

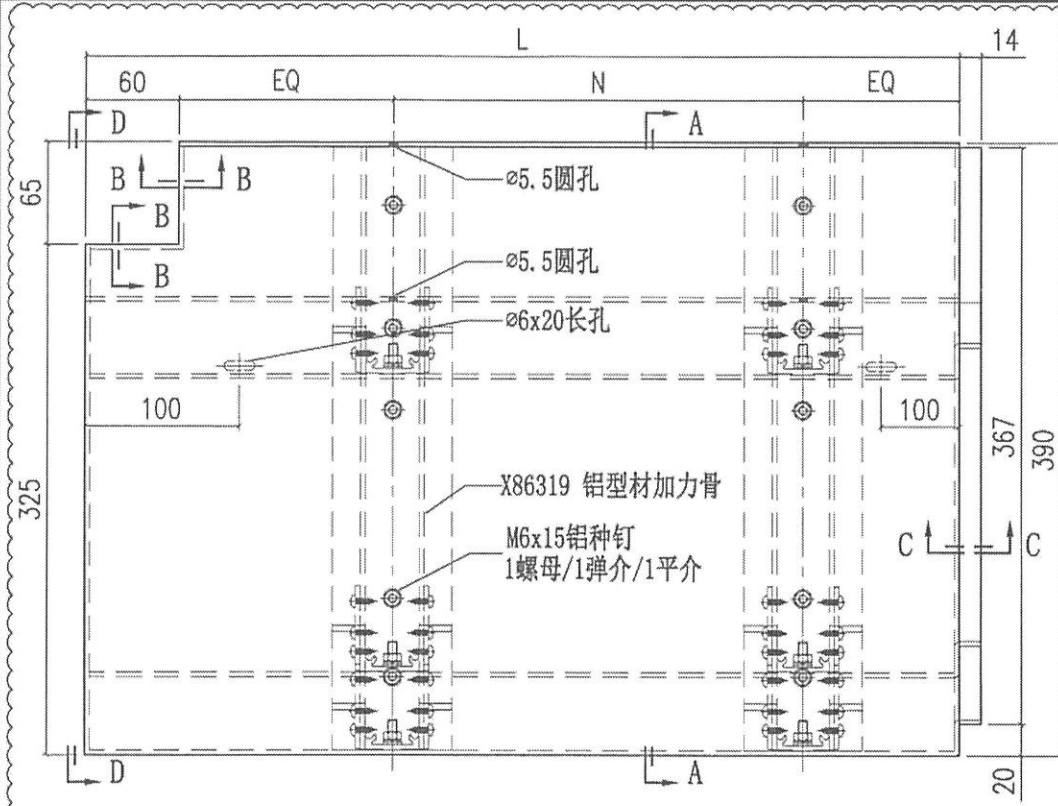

编号	L	N
AQ-312A	817.5	Ø300c/cx2

T3AE

D67

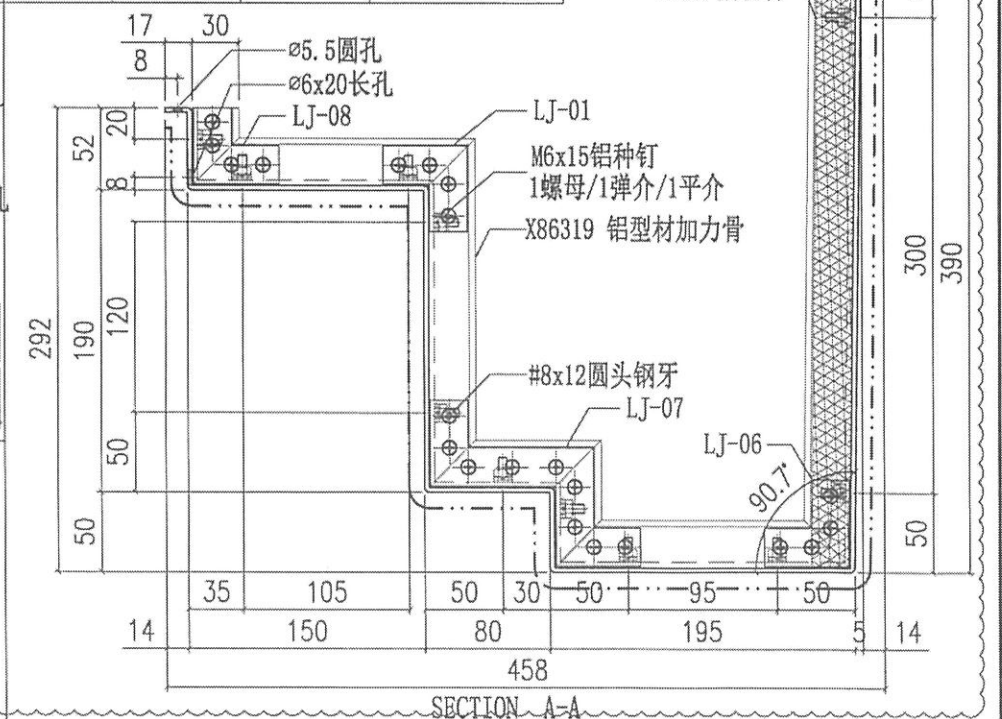
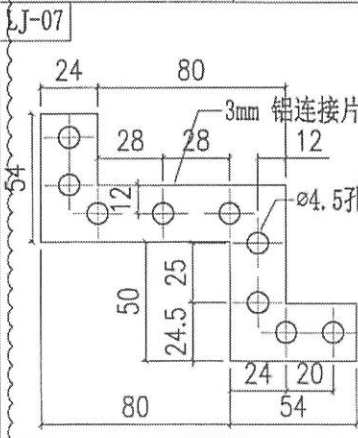
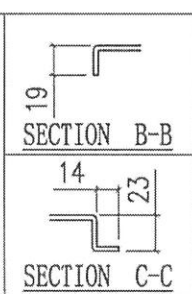
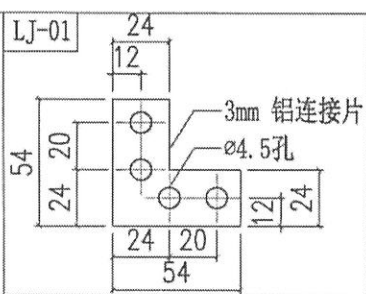
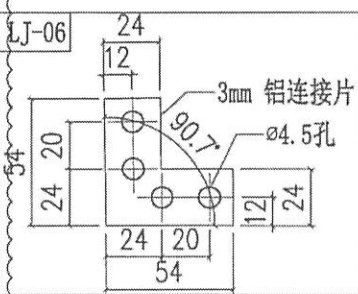
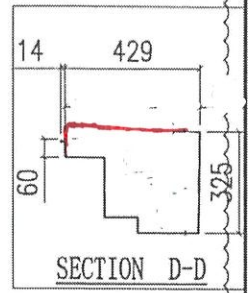



美特铝质有限公司
MIDI Aluminium Fabricator Ltd.

工程號	J858	類別		物料號	-				
地盘	康城11期	制圖	J.L.	2023-08-01	圖號	AQ-204			
修改	A	採用工廠	✓	圖紙名稱	铝板加工图	復核	-	數量	-
日期	05/10	材料颜色	玫瑰金 (E003X1010 05-3F1)	材料	3mm THK. 铝板	批准	-	單件重量	- (KG)

编号	L	N
AQ-204A	1019.5	Ø250c/cx2

T3 BD

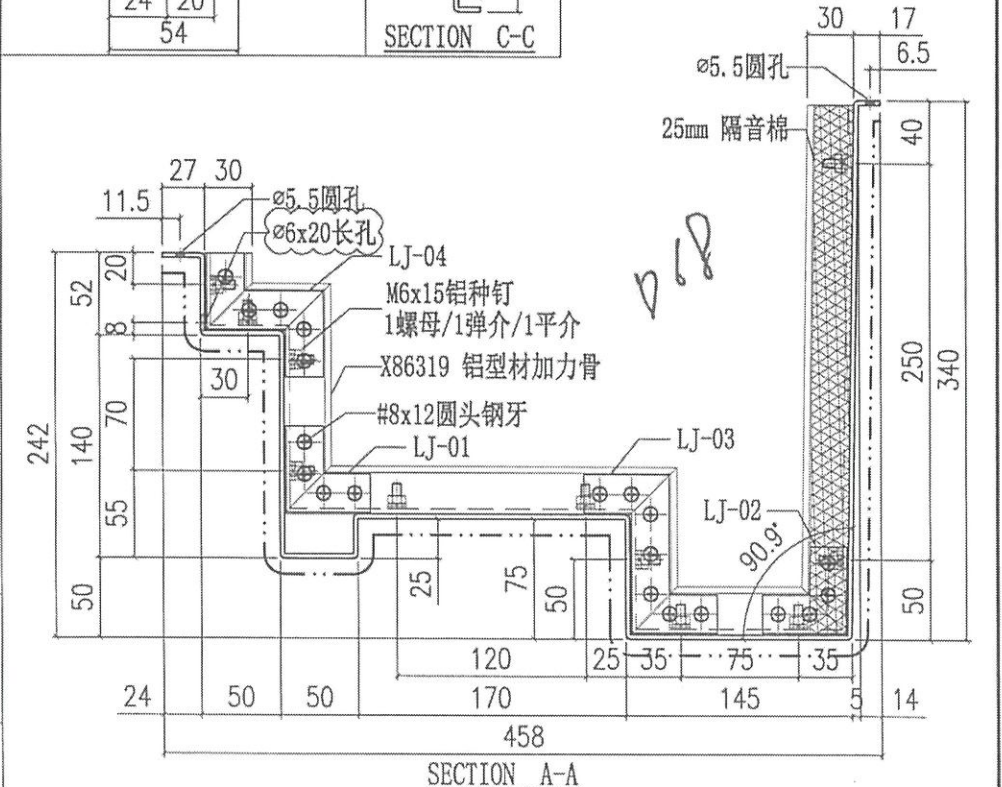
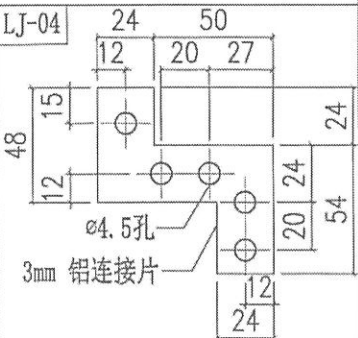
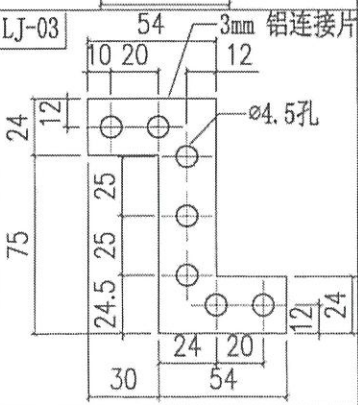
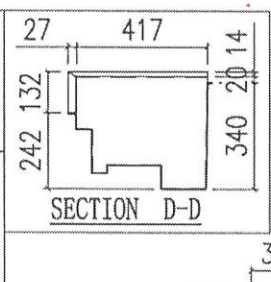
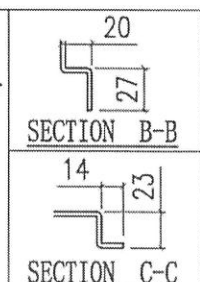
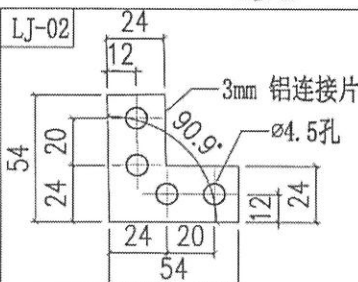
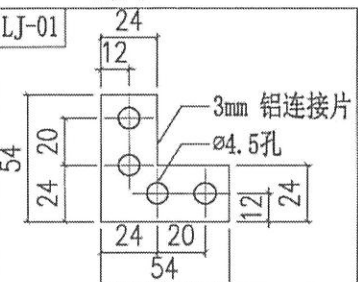
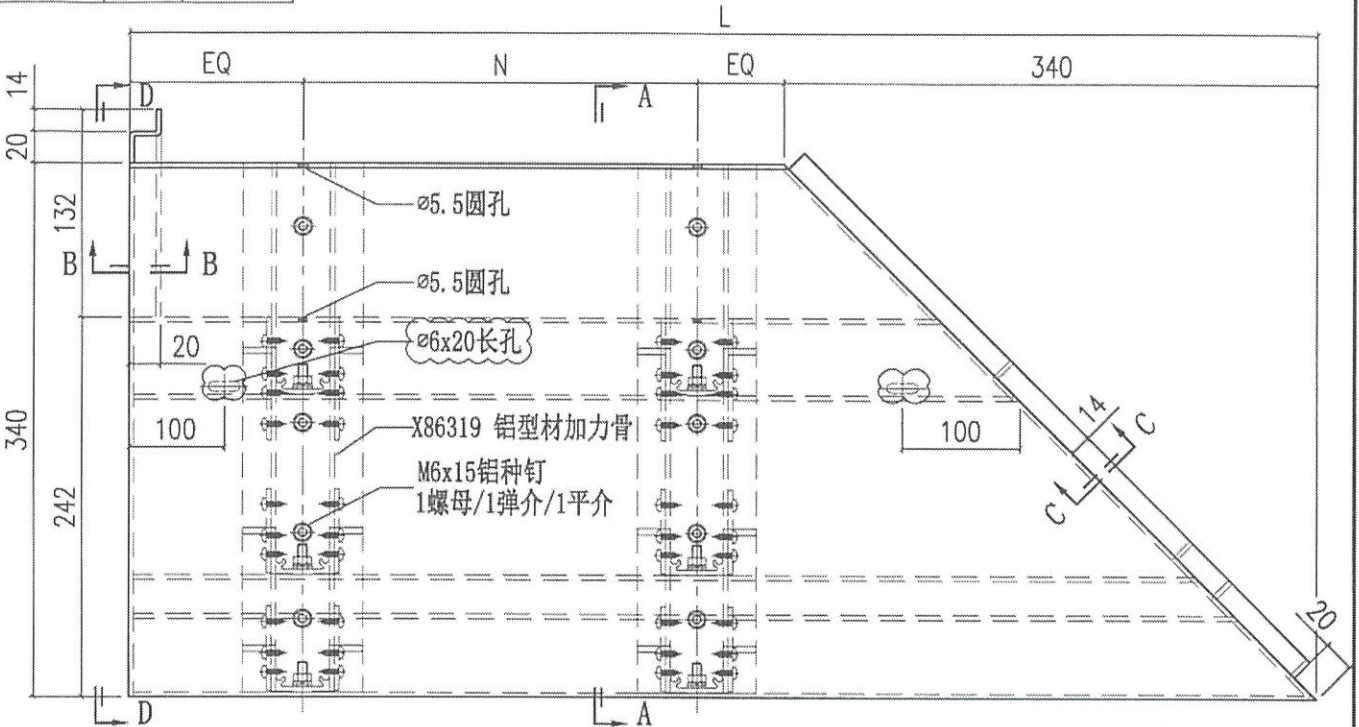

 美特鋁質有限公司 MIDI Aluminium Fabricator Ltd.		工程號 J858 地盘 康城11期 图纸名称 铝板加工图	類別 制圖 J.L. 復核 - 批准 -	物料號 - 2023-08-01 圖號 AQ-202 數量 - 單件重量 - (KG)
修改 A 日期 05/10	採用工廠 材料颜色 玫瑰金 (E03X1010 05-XP1)	地盤 ✓ 材料 3mm THK. 铝板		

编号	L	N
AQ-202A	1019.5	@250c/cx2

T3BC

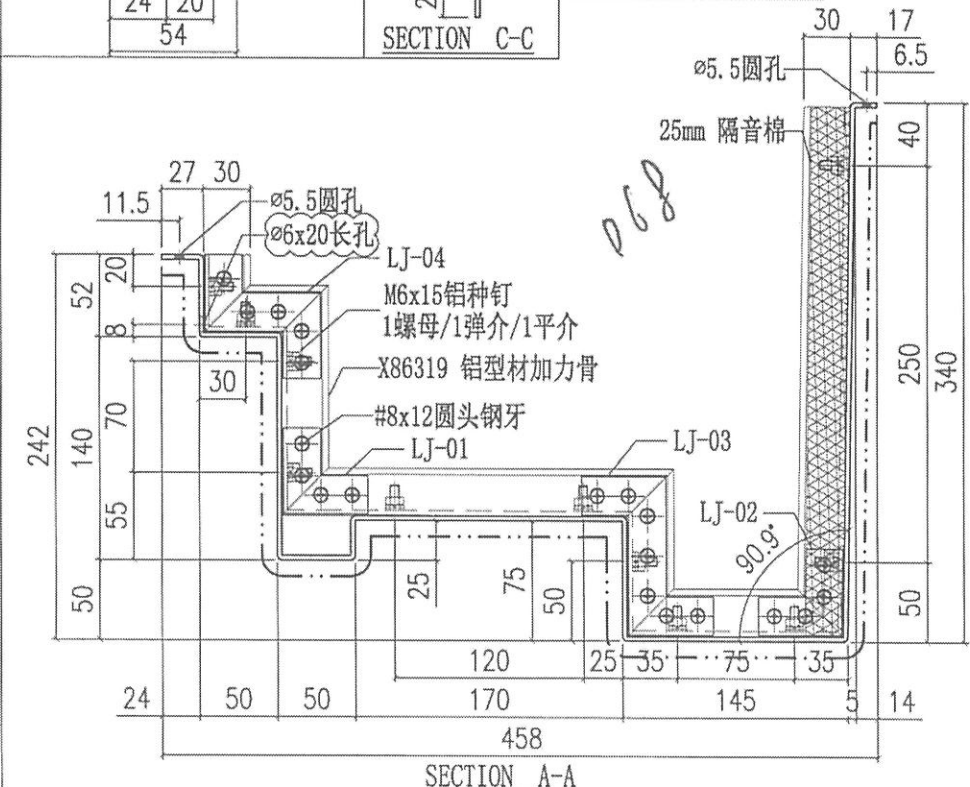
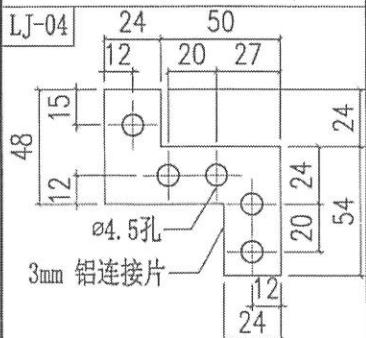
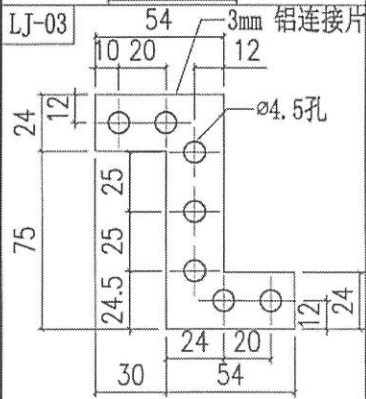
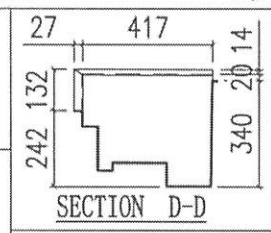
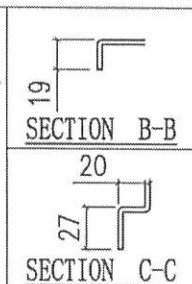
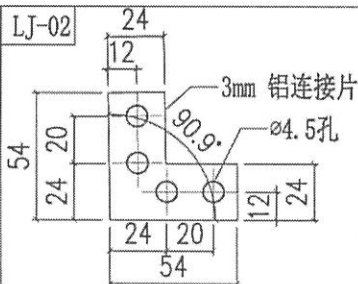
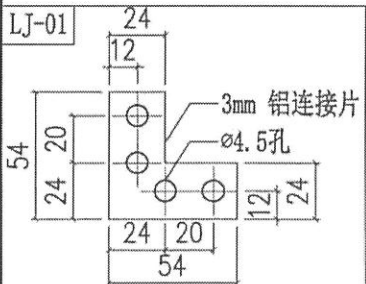
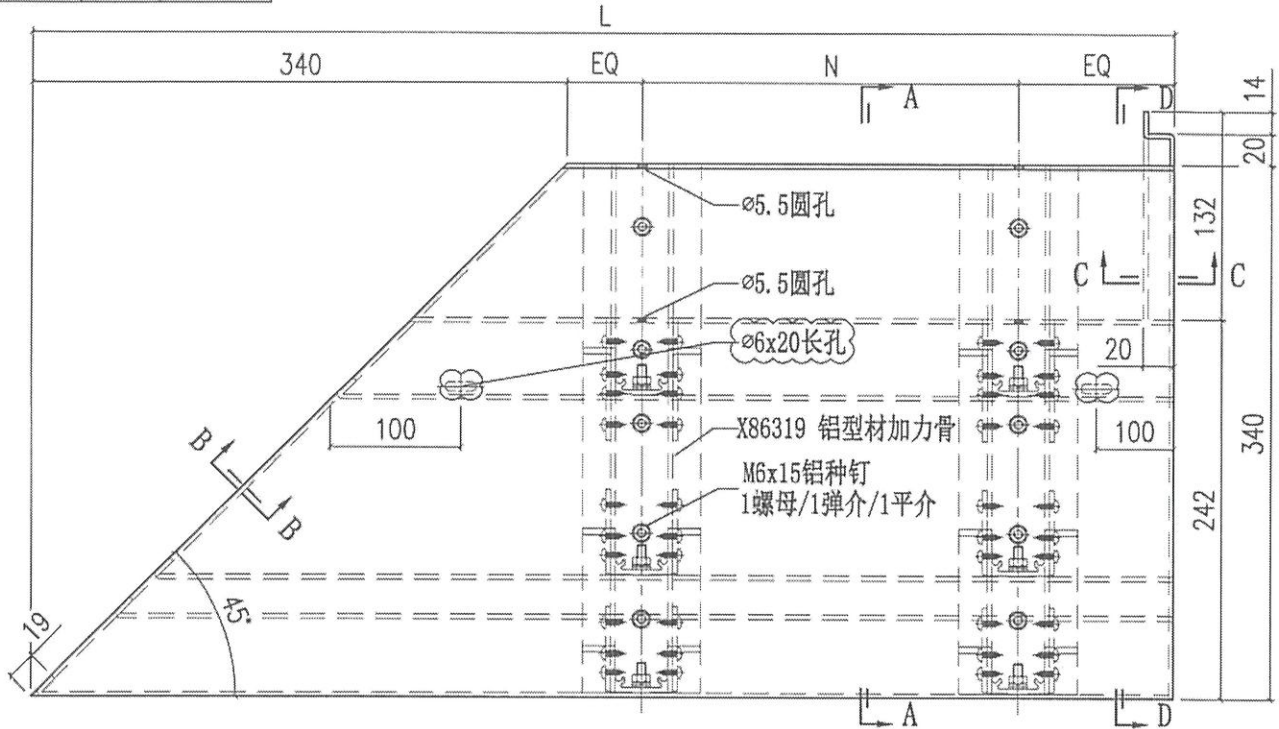



美特鋁質有限公司
MIDI Aluminium Fabricator Ltd.

工程號	J858	類別		物料號	-	
地盘	康城11期	制圖	J.L.	2023-08-01	圖號	AQ-120.1
修改	A	採用工廠			數量	-
日期	05/03	材料颜色	香槟金 (C3D3X10099S-JF2)		單件重量	- (KG)
图纸名称	铝板加工图	復核	-			
- 材料	3mm THK. 铝板	批准	-			

编号	L	N	A
AQ-120.1A	508	300	29

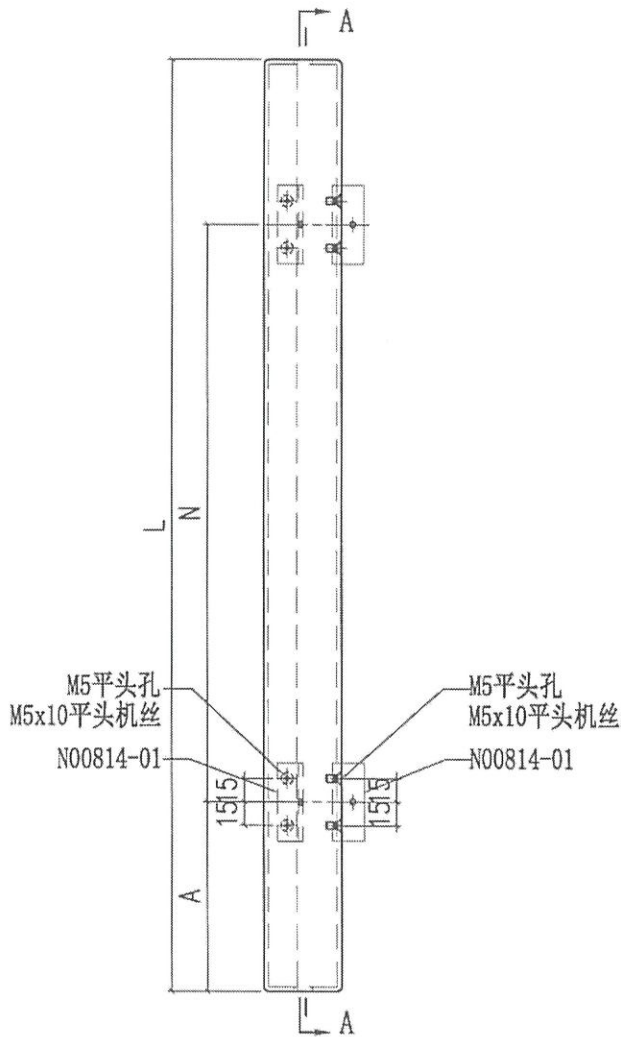

T3 67 BB.
企身.

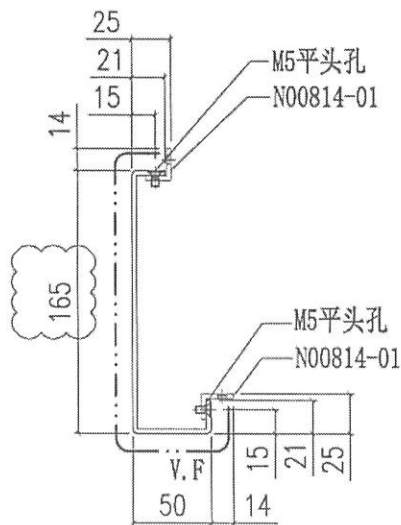

SECTION A-A

D40A

T3

T3 BD

T3 BE

T3 BF

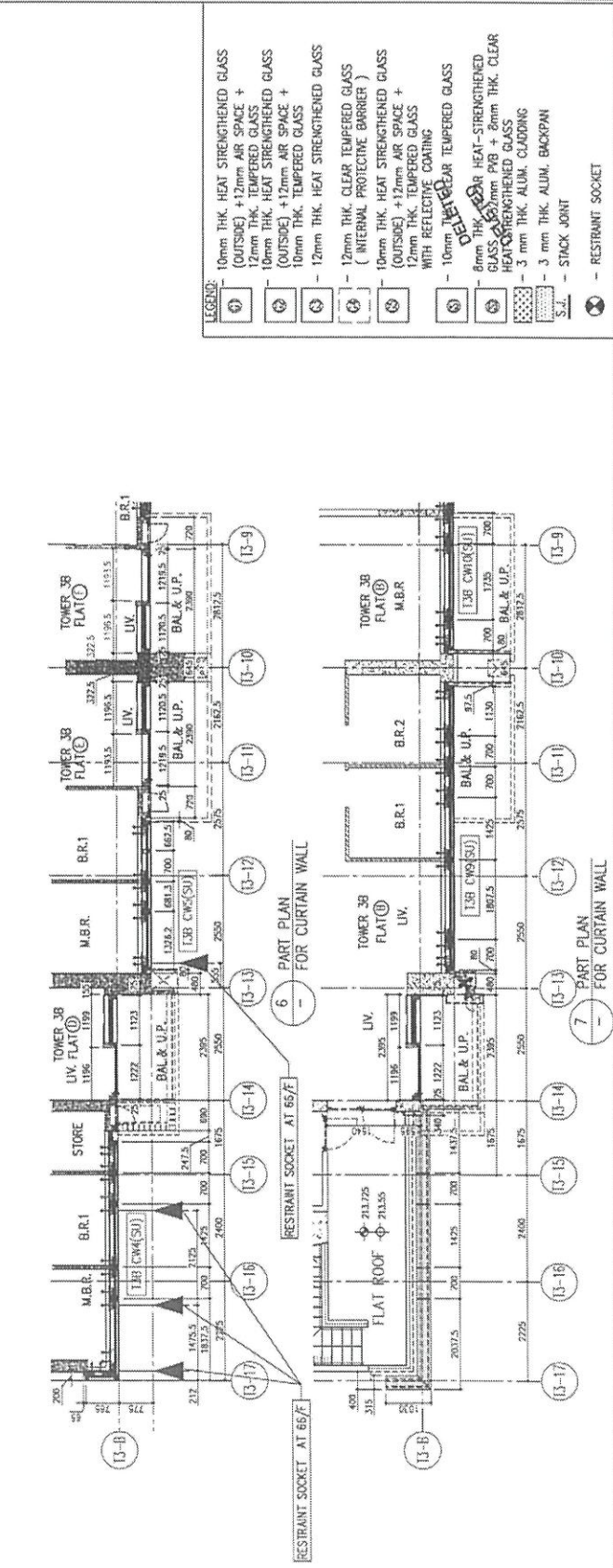
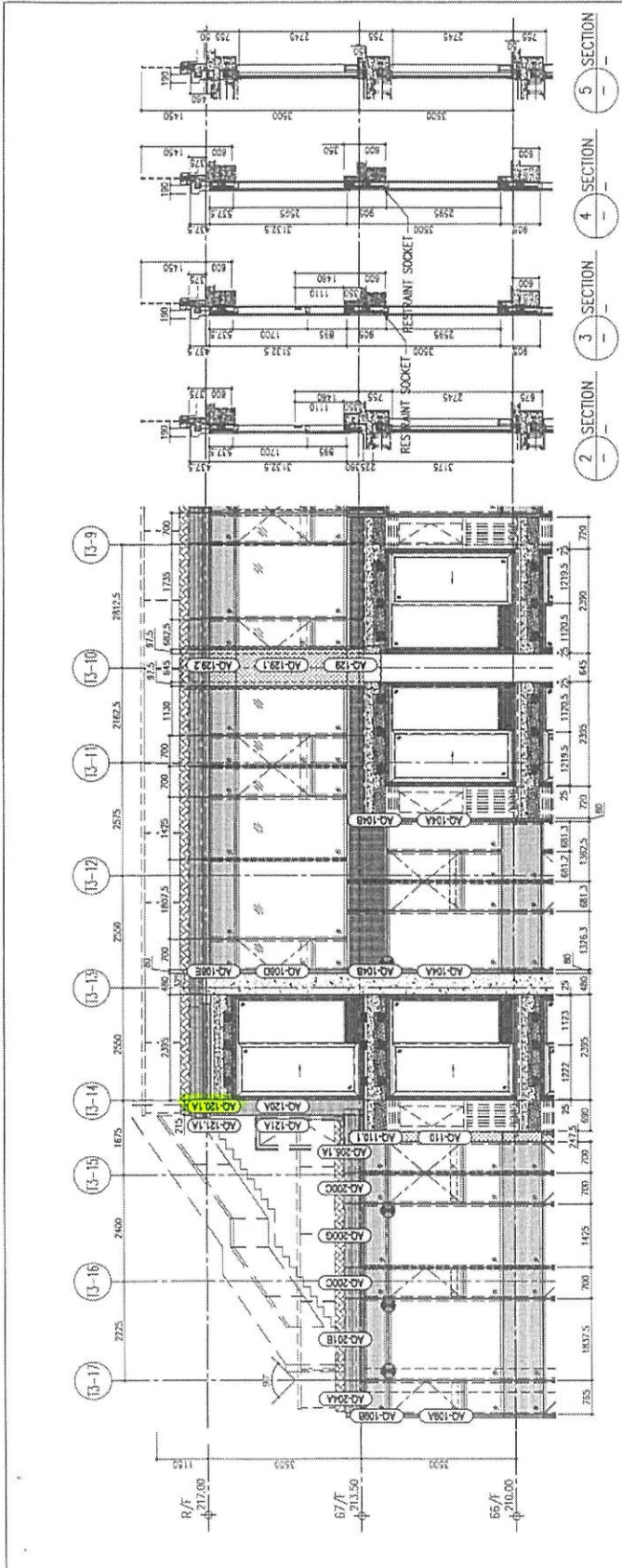

LEGEND:

①	10mm THK. HEAT STRENGTHENED GLASS (OUTSIDE) + 12mm AIR SPACE + 12mm THK. TEMPERED GLASS
②	10mm THK. HEAT STRENGTHENED GLASS (OUTSIDE) + 12mm AIR SPACE + 10mm THK. TEMPERED GLASS
③	12mm THK. HEAT STRENGTHENED GLASS (OUTSIDE) + 12mm AIR SPACE + 10mm THK. HEAT STRENGTHENED GLASS (INTERNAL PROTECTIVE BARRIER)
④	10mm THK. HEAT STRENGTHENED GLASS (OUTSIDE) + 12mm AIR SPACE + 12mm THK. TEMPERED GLASS WITH REFLECTIVE COATING
⑤	10mm THK. HEAT STRENGTHENED GLASS (OUTSIDE) + 12mm AIR SPACE + 12mm THK. CLEAR TEMPERED GLASS (INTERNAL PROTECTIVE BARRIER)
⑥	10mm THK. HEAT STRENGTHENED GLASS (OUTSIDE) + 12mm AIR SPACE + 12mm THK. CLEAR TEMPERED GLASS WITH REFLECTIVE COATING
⑦	6mm THK. HEAT STRENGTHENED GLASS + 12mm PVB + 8mm THK. CLEAR HEAT STRENGTHENED GLASS
⑧	3 mm THK. ALUM. BACKPAN
⑨	STACK JOINT
⊗	RESTRAINT SOCKET

B.D. REF :

CLIENT : 香港地產有限公司
Sino Land Company Limited

ARCHITECT : HOKU & PARTNERS
HOKU & PARTNERS (HK) Ltd
香港地產有限公司 (香港) 建築師行

MAIN CONTRACTOR : Gammon

STRUCTURAL ENGINEER : AECOM

FAKRE CONSULTANT : AECOM

SCALE :

1. ALL DIMENSIONS ARE IN mm.
2. ALL DIMENSIONS ARE VIEWED FROM OUTSIDE.
3. ELEVATIONS ARE TO BE TURNED ON SITE.
4. BEFORE FABRICATION.

LEGEND :

① — REIN. MARK NO.
② — REIN. SHEET NO.

1. FFL — FINISHED FLOOR LEVEL
2. SCL — STRUCTURAL FLOOR LEVEL
3. — REVERSED DETAIL

JOB NO. : J-858

PROJECT : PROPOSED RESIDENTIAL DEVELOPMENT AT NORTH TOWER PHASE 1A, LEASING PARK, TSEUNG KOWAN O, N.T.

TITLE : PENTHOUSE FLOOR PARTIAL ELEVATION & SECTION, PLAN FOR CURTAIN WALL (TOWER 3)

DATE : 22-06-21

SCALE : 1:50(A1)

DRAWN BY :

CHECKED BY :

DESIGNED BY :

DATE : 22-06-21

SCALE : 1:50(A1)

CLIENT : 美特 裕實有限公司
MIDI MANAGEMENT CORPORATION LTD
Units 1-8, Sunny Industrial Centre, 1/F
142,140B,141-1, Leung King Road, Tseung Kwan O, N.T.

REV. : E

T3

T3 BD

T3 BE

T3 BF

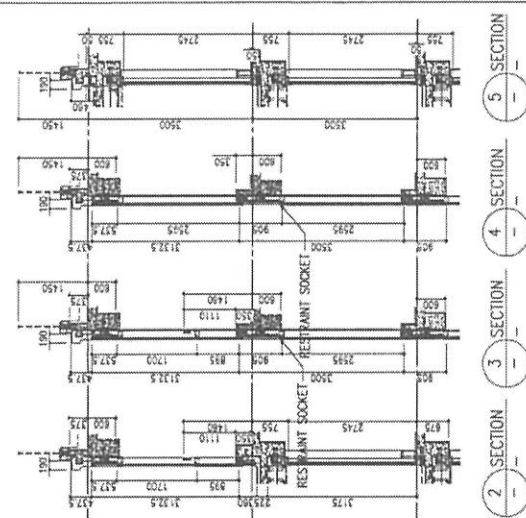
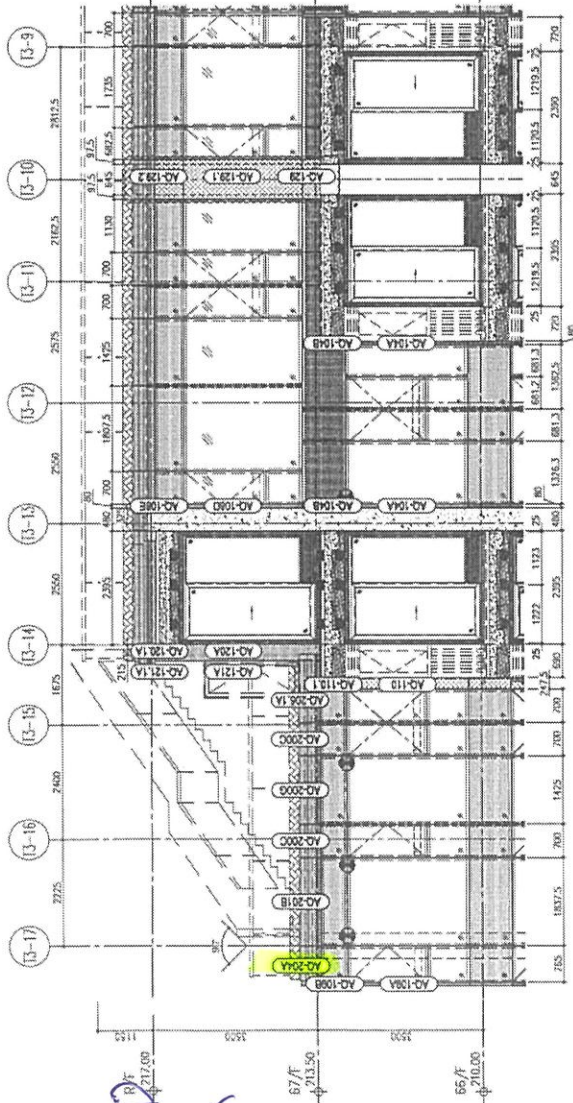

- LEGEND:**
- ① 10mm THK. HEAT STRENGTHENED GLASS (OUTSIDE) + 12mm AIR SPACE + 12mm THK. TEMPERED GLASS
 - ② 10mm THK. HEAT STRENGTHENED GLASS (OUTSIDE) + 12mm AIR SPACE + 10mm THK. TEMPERED GLASS
 - ③ 12mm THK. HEAT STRENGTHENED GLASS
 - ④ 12mm THK. CLEAR TEMPERED GLASS (INTERNAL PROTECTIVE BARRIER)
 - ⑤ 10mm THK. HEAT STRENGTHENED GLASS (OUTSIDE) + 12mm AIR SPACE + 12mm THK. TEMPERED GLASS WITH REFLECTIVE COATING
 - ⑥ 10mm THK. ~~TEMPERED~~ CLEAR TEMPERED GLASS
 - ⑦ 8mm THK. ~~TEMPERED~~ HEAT-STRENGTHENED GLASS + 12mm AIR SPACE + 8mm THK. CLEAR HEAT-STRENGTHENED GLASS
 - ⑧ 3 mm THK. ALUM. BACKPAN
 - S.S. - STACK JOINT
 - ⊗ - RESTRAINT SOCKET

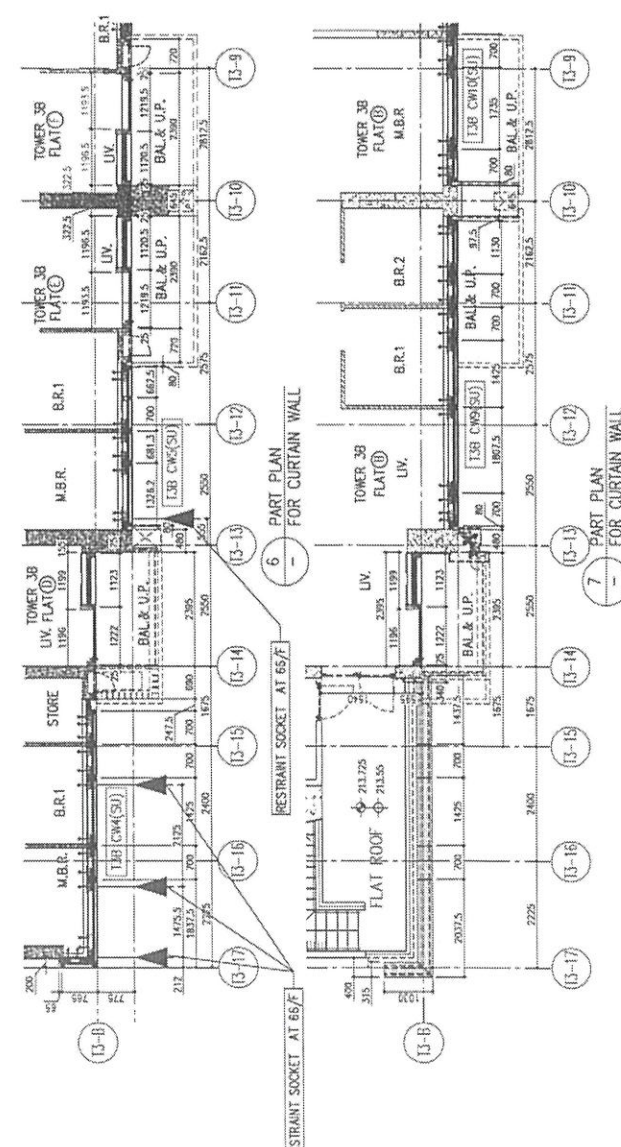

BD. REF :		Sino Land Company Limited Pensolid Pensolid & Partners Pensolid (HK) Ltd 23/F, 2300000000 (香港) 中環皇后大道中 MAIN CONTRACTOR :																																																																																																																																																																																																																																																																																																																
Gammon STRUCTURAL ENGINEER : AECOM TACKLE CONSULTANT : AECOM		MISC. : 1. ALL DIMENSIONS ARE IN mm 2. ALL DIMENSIONS ARE VIEWED FROM OUTSIDE 3. ALL DIMENSIONS ARE TO BE WORKED ON SITE LEGEND : REFERENCE MARK NO. FINISH FLOOR LEVEL STRUCTURAL FLOOR LEVEL RETAINED LEVEL																																																																																																																																																																																																																																																																																																																
CURVE : JOB NO. : J-858 PROJECT : PROPOSED RESIDENTIAL DEVELOPMENT AT THEL TOWER PHASE 11, LUDGAS PARK BEIJING HUAN O, HK.		<table border="1"> <tr><th>NO.</th><th>DATE</th><th>REVISION</th></tr> <tr><td>1</td><td>25/07/23</td><td>ISSUED AS PER COMMENTS</td></tr> <tr><td>2</td><td>15/07/23</td><td>ISSUED AS PER COMMENTS</td></tr> <tr><td>3</td><td>15/07/23</td><td>ISSUED AS PER COMMENTS</td></tr> <tr><td>4</td><td>15/07/23</td><td>ISSUED AS PER COMMENTS</td></tr> <tr><td>5</td><td>15/07/23</td><td>ISSUED AS PER COMMENTS</td></tr> <tr><td>6</td><td>15/07/23</td><td>ISSUED AS PER COMMENTS</td></tr> <tr><td>7</td><td>15/07/23</td><td>ISSUED AS PER COMMENTS</td></tr> <tr><td>8</td><td>15/07/23</td><td>ISSUED AS PER COMMENTS</td></tr> <tr><td>9</td><td>15/07/23</td><td>ISSUED AS PER COMMENTS</td></tr> <tr><td>10</td><td>15/07/23</td><td>ISSUED AS PER COMMENTS</td></tr> <tr><td>11</td><td>15/07/23</td><td>ISSUED AS PER COMMENTS</td></tr> <tr><td>12</td><td>15/07/23</td><td>ISSUED AS PER COMMENTS</td></tr> <tr><td>13</td><td>15/07/23</td><td>ISSUED AS PER COMMENTS</td></tr> <tr><td>14</td><td>15/07/23</td><td>ISSUED AS PER COMMENTS</td></tr> <tr><td>15</td><td>15/07/23</td><td>ISSUED AS PER COMMENTS</td></tr> <tr><td>16</td><td>15/07/23</td><td>ISSUED AS PER COMMENTS</td></tr> <tr><td>17</td><td>15/07/23</td><td>ISSUED AS PER COMMENTS</td></tr> <tr><td>18</td><td>15/07/23</td><td>ISSUED AS PER COMMENTS</td></tr> <tr><td>19</td><td>15/07/23</td><td>ISSUED AS PER COMMENTS</td></tr> <tr><td>20</td><td>15/07/23</td><td>ISSUED AS PER COMMENTS</td></tr> <tr><td>21</td><td>15/07/23</td><td>ISSUED AS PER COMMENTS</td></tr> <tr><td>22</td><td>15/07/23</td><td>ISSUED AS PER COMMENTS</td></tr> <tr><td>23</td><td>15/07/23</td><td>ISSUED AS PER COMMENTS</td></tr> <tr><td>24</td><td>15/07/23</td><td>ISSUED AS PER COMMENTS</td></tr> <tr><td>25</td><td>15/07/23</td><td>ISSUED AS PER COMMENTS</td></tr> <tr><td>26</td><td>15/07/23</td><td>ISSUED AS PER COMMENTS</td></tr> <tr><td>27</td><td>15/07/23</td><td>ISSUED AS PER COMMENTS</td></tr> <tr><td>28</td><td>15/07/23</td><td>ISSUED AS PER COMMENTS</td></tr> <tr><td>29</td><td>15/07/23</td><td>ISSUED AS PER COMMENTS</td></tr> <tr><td>30</td><td>15/07/23</td><td>ISSUED AS PER COMMENTS</td></tr> <tr><td>31</td><td>15/07/23</td><td>ISSUED AS PER COMMENTS</td></tr> <tr><td>32</td><td>15/07/23</td><td>ISSUED AS PER COMMENTS</td></tr> <tr><td>33</td><td>15/07/23</td><td>ISSUED AS PER COMMENTS</td></tr> <tr><td>34</td><td>15/07/23</td><td>ISSUED AS PER COMMENTS</td></tr> <tr><td>35</td><td>15/07/23</td><td>ISSUED AS PER COMMENTS</td></tr> <tr><td>36</td><td>15/07/23</td><td>ISSUED AS PER COMMENTS</td></tr> <tr><td>37</td><td>15/07/23</td><td>ISSUED AS PER COMMENTS</td></tr> <tr><td>38</td><td>15/07/23</td><td>ISSUED AS PER COMMENTS</td></tr> <tr><td>39</td><td>15/07/23</td><td>ISSUED AS PER COMMENTS</td></tr> <tr><td>40</td><td>15/07/23</td><td>ISSUED AS PER COMMENTS</td></tr> <tr><td>41</td><td>15/07/23</td><td>ISSUED AS PER COMMENTS</td></tr> <tr><td>42</td><td>15/07/23</td><td>ISSUED AS PER COMMENTS</td></tr> <tr><td>43</td><td>15/07/23</td><td>ISSUED AS PER COMMENTS</td></tr> <tr><td>44</td><td>15/07/23</td><td>ISSUED AS PER COMMENTS</td></tr> <tr><td>45</td><td>15/07/23</td><td>ISSUED AS PER COMMENTS</td></tr> <tr><td>46</td><td>15/07/23</td><td>ISSUED AS PER COMMENTS</td></tr> <tr><td>47</td><td>15/07/23</td><td>ISSUED AS PER COMMENTS</td></tr> <tr><td>48</td><td>15/07/23</td><td>ISSUED AS PER COMMENTS</td></tr> <tr><td>49</td><td>15/07/23</td><td>ISSUED AS PER COMMENTS</td></tr> <tr><td>50</td><td>15/07/23</td><td>ISSUED AS PER COMMENTS</td></tr> <tr><td>51</td><td>15/07/23</td><td>ISSUED AS PER COMMENTS</td></tr> <tr><td>52</td><td>15/07/23</td><td>ISSUED AS PER COMMENTS</td></tr> <tr><td>53</td><td>15/07/23</td><td>ISSUED AS PER COMMENTS</td></tr> <tr><td>54</td><td>15/07/23</td><td>ISSUED AS PER COMMENTS</td></tr> <tr><td>55</td><td>15/07/23</td><td>ISSUED AS PER COMMENTS</td></tr> <tr><td>56</td><td>15/07/23</td><td>ISSUED AS PER COMMENTS</td></tr> <tr><td>57</td><td>15/07/23</td><td>ISSUED AS PER COMMENTS</td></tr> <tr><td>58</td><td>15/07/23</td><td>ISSUED AS PER COMMENTS</td></tr> <tr><td>59</td><td>15/07/23</td><td>ISSUED AS PER COMMENTS</td></tr> <tr><td>60</td><td>15/07/23</td><td>ISSUED AS PER COMMENTS</td></tr> <tr><td>61</td><td>15/07/23</td><td>ISSUED AS PER COMMENTS</td></tr> <tr><td>62</td><td>15/07/23</td><td>ISSUED AS PER COMMENTS</td></tr> <tr><td>63</td><td>15/07/23</td><td>ISSUED AS PER COMMENTS</td></tr> <tr><td>64</td><td>15/07/23</td><td>ISSUED AS PER COMMENTS</td></tr> <tr><td>65</td><td>15/07/23</td><td>ISSUED AS PER COMMENTS</td></tr> <tr><td>66</td><td>15/07/23</td><td>ISSUED AS PER COMMENTS</td></tr> <tr><td>67</td><td>15/07/23</td><td>ISSUED AS PER COMMENTS</td></tr> <tr><td>68</td><td>15/07/23</td><td>ISSUED AS PER COMMENTS</td></tr> <tr><td>69</td><td>15/07/23</td><td>ISSUED AS PER COMMENTS</td></tr> <tr><td>70</td><td>15/07/23</td><td>ISSUED AS PER COMMENTS</td></tr> <tr><td>71</td><td>15/07/23</td><td>ISSUED AS PER COMMENTS</td></tr> <tr><td>72</td><td>15/07/23</td><td>ISSUED AS PER COMMENTS</td></tr> <tr><td>73</td><td>15/07/23</td><td>ISSUED AS PER COMMENTS</td></tr> <tr><td>74</td><td>15/07/23</td><td>ISSUED AS PER COMMENTS</td></tr> <tr><td>75</td><td>15/07/23</td><td>ISSUED AS PER COMMENTS</td></tr> <tr><td>76</td><td>15/07/23</td><td>ISSUED AS PER COMMENTS</td></tr> <tr><td>77</td><td>15/07/23</td><td>ISSUED AS PER COMMENTS</td></tr> <tr><td>78</td><td>15/07/23</td><td>ISSUED AS PER COMMENTS</td></tr> <tr><td>79</td><td>15/07/23</td><td>ISSUED AS PER COMMENTS</td></tr> <tr><td>80</td><td>15/07/23</td><td>ISSUED AS PER COMMENTS</td></tr> <tr><td>81</td><td>15/07/23</td><td>ISSUED AS PER COMMENTS</td></tr> <tr><td>82</td><td>15/07/23</td><td>ISSUED AS PER COMMENTS</td></tr> <tr><td>83</td><td>15/07/23</td><td>ISSUED AS PER COMMENTS</td></tr> <tr><td>84</td><td>15/07/23</td><td>ISSUED AS PER COMMENTS</td></tr> <tr><td>85</td><td>15/07/23</td><td>ISSUED AS PER COMMENTS</td></tr> <tr><td>86</td><td>15/07/23</td><td>ISSUED AS PER COMMENTS</td></tr> <tr><td>87</td><td>15/07/23</td><td>ISSUED AS PER COMMENTS</td></tr> <tr><td>88</td><td>15/07/23</td><td>ISSUED AS PER COMMENTS</td></tr> <tr><td>89</td><td>15/07/23</td><td>ISSUED AS PER COMMENTS</td></tr> <tr><td>90</td><td>15/07/23</td><td>ISSUED AS PER COMMENTS</td></tr> <tr><td>91</td><td>15/07/23</td><td>ISSUED AS PER COMMENTS</td></tr> <tr><td>92</td><td>15/07/23</td><td>ISSUED AS PER COMMENTS</td></tr> <tr><td>93</td><td>15/07/23</td><td>ISSUED AS PER COMMENTS</td></tr> <tr><td>94</td><td>15/07/23</td><td>ISSUED AS PER COMMENTS</td></tr> <tr><td>95</td><td>15/07/23</td><td>ISSUED AS PER COMMENTS</td></tr> <tr><td>96</td><td>15/07/23</td><td>ISSUED AS PER COMMENTS</td></tr> <tr><td>97</td><td>15/07/23</td><td>ISSUED AS PER COMMENTS</td></tr> <tr><td>98</td><td>15/07/23</td><td>ISSUED AS PER COMMENTS</td></tr> <tr><td>99</td><td>15/07/23</td><td>ISSUED AS PER COMMENTS</td></tr> <tr><td>100</td><td>15/07/23</td><td>ISSUED AS PER COMMENTS</td></tr> </table>		NO.	DATE	REVISION	1	25/07/23	ISSUED AS PER COMMENTS	2	15/07/23	ISSUED AS PER COMMENTS	3	15/07/23	ISSUED AS PER COMMENTS	4	15/07/23	ISSUED AS PER COMMENTS	5	15/07/23	ISSUED AS PER COMMENTS	6	15/07/23	ISSUED AS PER COMMENTS	7	15/07/23	ISSUED AS PER COMMENTS	8	15/07/23	ISSUED AS PER COMMENTS	9	15/07/23	ISSUED AS PER COMMENTS	10	15/07/23	ISSUED AS PER COMMENTS	11	15/07/23	ISSUED AS PER COMMENTS	12	15/07/23	ISSUED AS PER COMMENTS	13	15/07/23	ISSUED AS PER COMMENTS	14	15/07/23	ISSUED AS PER COMMENTS	15	15/07/23	ISSUED AS PER COMMENTS	16	15/07/23	ISSUED AS PER COMMENTS	17	15/07/23	ISSUED AS PER COMMENTS	18	15/07/23	ISSUED AS PER COMMENTS	19	15/07/23	ISSUED AS PER COMMENTS	20	15/07/23	ISSUED AS PER COMMENTS	21	15/07/23	ISSUED AS PER COMMENTS	22	15/07/23	ISSUED AS PER COMMENTS	23	15/07/23	ISSUED AS PER COMMENTS	24	15/07/23	ISSUED AS PER COMMENTS	25	15/07/23	ISSUED AS PER COMMENTS	26	15/07/23	ISSUED AS PER COMMENTS	27	15/07/23	ISSUED AS PER COMMENTS	28	15/07/23	ISSUED AS PER COMMENTS	29	15/07/23	ISSUED AS PER COMMENTS	30	15/07/23	ISSUED AS PER COMMENTS	31	15/07/23	ISSUED AS PER COMMENTS	32	15/07/23	ISSUED AS PER COMMENTS	33	15/07/23	ISSUED AS PER COMMENTS	34	15/07/23	ISSUED AS PER COMMENTS	35	15/07/23	ISSUED AS PER COMMENTS	36	15/07/23	ISSUED AS PER COMMENTS	37	15/07/23	ISSUED AS PER COMMENTS	38	15/07/23	ISSUED AS PER COMMENTS	39	15/07/23	ISSUED AS PER COMMENTS	40	15/07/23	ISSUED AS PER COMMENTS	41	15/07/23	ISSUED AS PER COMMENTS	42	15/07/23	ISSUED AS PER COMMENTS	43	15/07/23	ISSUED AS PER COMMENTS	44	15/07/23	ISSUED AS PER COMMENTS	45	15/07/23	ISSUED AS PER COMMENTS	46	15/07/23	ISSUED AS PER COMMENTS	47	15/07/23	ISSUED AS PER COMMENTS	48	15/07/23	ISSUED AS PER COMMENTS	49	15/07/23	ISSUED AS PER COMMENTS	50	15/07/23	ISSUED AS PER COMMENTS	51	15/07/23	ISSUED AS PER COMMENTS	52	15/07/23	ISSUED AS PER COMMENTS	53	15/07/23	ISSUED AS PER COMMENTS	54	15/07/23	ISSUED AS PER COMMENTS	55	15/07/23	ISSUED AS PER COMMENTS	56	15/07/23	ISSUED AS PER COMMENTS	57	15/07/23	ISSUED AS PER COMMENTS	58	15/07/23	ISSUED AS PER COMMENTS	59	15/07/23	ISSUED AS PER COMMENTS	60	15/07/23	ISSUED AS PER COMMENTS	61	15/07/23	ISSUED AS PER COMMENTS	62	15/07/23	ISSUED AS PER COMMENTS	63	15/07/23	ISSUED AS PER COMMENTS	64	15/07/23	ISSUED AS PER COMMENTS	65	15/07/23	ISSUED AS PER COMMENTS	66	15/07/23	ISSUED AS PER COMMENTS	67	15/07/23	ISSUED AS PER COMMENTS	68	15/07/23	ISSUED AS PER COMMENTS	69	15/07/23	ISSUED AS PER COMMENTS	70	15/07/23	ISSUED AS PER COMMENTS	71	15/07/23	ISSUED AS PER COMMENTS	72	15/07/23	ISSUED AS PER COMMENTS	73	15/07/23	ISSUED AS PER COMMENTS	74	15/07/23	ISSUED AS PER COMMENTS	75	15/07/23	ISSUED AS PER COMMENTS	76	15/07/23	ISSUED AS PER COMMENTS	77	15/07/23	ISSUED AS PER COMMENTS	78	15/07/23	ISSUED AS PER COMMENTS	79	15/07/23	ISSUED AS PER COMMENTS	80	15/07/23	ISSUED AS PER COMMENTS	81	15/07/23	ISSUED AS PER COMMENTS	82	15/07/23	ISSUED AS PER COMMENTS	83	15/07/23	ISSUED AS PER COMMENTS	84	15/07/23	ISSUED AS PER COMMENTS	85	15/07/23	ISSUED AS PER COMMENTS	86	15/07/23	ISSUED AS PER COMMENTS	87	15/07/23	ISSUED AS PER COMMENTS	88	15/07/23	ISSUED AS PER COMMENTS	89	15/07/23	ISSUED AS PER COMMENTS	90	15/07/23	ISSUED AS PER COMMENTS	91	15/07/23	ISSUED AS PER COMMENTS	92	15/07/23	ISSUED AS PER COMMENTS	93	15/07/23	ISSUED AS PER COMMENTS	94	15/07/23	ISSUED AS PER COMMENTS	95	15/07/23	ISSUED AS PER COMMENTS	96	15/07/23	ISSUED AS PER COMMENTS	97	15/07/23	ISSUED AS PER COMMENTS	98	15/07/23	ISSUED AS PER COMMENTS	99	15/07/23	ISSUED AS PER COMMENTS	100	15/07/23	ISSUED AS PER COMMENTS
NO.	DATE	REVISION																																																																																																																																																																																																																																																																																																																
1	25/07/23	ISSUED AS PER COMMENTS																																																																																																																																																																																																																																																																																																																
2	15/07/23	ISSUED AS PER COMMENTS																																																																																																																																																																																																																																																																																																																
3	15/07/23	ISSUED AS PER COMMENTS																																																																																																																																																																																																																																																																																																																
4	15/07/23	ISSUED AS PER COMMENTS																																																																																																																																																																																																																																																																																																																
5	15/07/23	ISSUED AS PER COMMENTS																																																																																																																																																																																																																																																																																																																
6	15/07/23	ISSUED AS PER COMMENTS																																																																																																																																																																																																																																																																																																																
7	15/07/23	ISSUED AS PER COMMENTS																																																																																																																																																																																																																																																																																																																
8	15/07/23	ISSUED AS PER COMMENTS																																																																																																																																																																																																																																																																																																																
9	15/07/23	ISSUED AS PER COMMENTS																																																																																																																																																																																																																																																																																																																
10	15/07/23	ISSUED AS PER COMMENTS																																																																																																																																																																																																																																																																																																																
11	15/07/23	ISSUED AS PER COMMENTS																																																																																																																																																																																																																																																																																																																
12	15/07/23	ISSUED AS PER COMMENTS																																																																																																																																																																																																																																																																																																																
13	15/07/23	ISSUED AS PER COMMENTS																																																																																																																																																																																																																																																																																																																
14	15/07/23	ISSUED AS PER COMMENTS																																																																																																																																																																																																																																																																																																																
15	15/07/23	ISSUED AS PER COMMENTS																																																																																																																																																																																																																																																																																																																
16	15/07/23	ISSUED AS PER COMMENTS																																																																																																																																																																																																																																																																																																																
17	15/07/23	ISSUED AS PER COMMENTS																																																																																																																																																																																																																																																																																																																
18	15/07/23	ISSUED AS PER COMMENTS																																																																																																																																																																																																																																																																																																																
19	15/07/23	ISSUED AS PER COMMENTS																																																																																																																																																																																																																																																																																																																
20	15/07/23	ISSUED AS PER COMMENTS																																																																																																																																																																																																																																																																																																																
21	15/07/23	ISSUED AS PER COMMENTS																																																																																																																																																																																																																																																																																																																
22	15/07/23	ISSUED AS PER COMMENTS																																																																																																																																																																																																																																																																																																																
23	15/07/23	ISSUED AS PER COMMENTS																																																																																																																																																																																																																																																																																																																
24	15/07/23	ISSUED AS PER COMMENTS																																																																																																																																																																																																																																																																																																																
25	15/07/23	ISSUED AS PER COMMENTS																																																																																																																																																																																																																																																																																																																
26	15/07/23	ISSUED AS PER COMMENTS																																																																																																																																																																																																																																																																																																																
27	15/07/23	ISSUED AS PER COMMENTS																																																																																																																																																																																																																																																																																																																
28	15/07/23	ISSUED AS PER COMMENTS																																																																																																																																																																																																																																																																																																																
29	15/07/23	ISSUED AS PER COMMENTS																																																																																																																																																																																																																																																																																																																
30	15/07/23	ISSUED AS PER COMMENTS																																																																																																																																																																																																																																																																																																																
31	15/07/23	ISSUED AS PER COMMENTS																																																																																																																																																																																																																																																																																																																
32	15/07/23	ISSUED AS PER COMMENTS																																																																																																																																																																																																																																																																																																																
33	15/07/23	ISSUED AS PER COMMENTS																																																																																																																																																																																																																																																																																																																
34	15/07/23	ISSUED AS PER COMMENTS																																																																																																																																																																																																																																																																																																																
35	15/07/23	ISSUED AS PER COMMENTS																																																																																																																																																																																																																																																																																																																
36	15/07/23	ISSUED AS PER COMMENTS																																																																																																																																																																																																																																																																																																																
37	15/07/23	ISSUED AS PER COMMENTS																																																																																																																																																																																																																																																																																																																
38	15/07/23	ISSUED AS PER COMMENTS																																																																																																																																																																																																																																																																																																																
39	15/07/23	ISSUED AS PER COMMENTS																																																																																																																																																																																																																																																																																																																
40	15/07/23	ISSUED AS PER COMMENTS																																																																																																																																																																																																																																																																																																																
41	15/07/23	ISSUED AS PER COMMENTS																																																																																																																																																																																																																																																																																																																
42	15/07/23	ISSUED AS PER COMMENTS																																																																																																																																																																																																																																																																																																																
43	15/07/23	ISSUED AS PER COMMENTS																																																																																																																																																																																																																																																																																																																
44	15/07/23	ISSUED AS PER COMMENTS																																																																																																																																																																																																																																																																																																																
45	15/07/23	ISSUED AS PER COMMENTS																																																																																																																																																																																																																																																																																																																
46	15/07/23	ISSUED AS PER COMMENTS																																																																																																																																																																																																																																																																																																																
47	15/07/23	ISSUED AS PER COMMENTS																																																																																																																																																																																																																																																																																																																
48	15/07/23	ISSUED AS PER COMMENTS																																																																																																																																																																																																																																																																																																																
49	15/07/23	ISSUED AS PER COMMENTS																																																																																																																																																																																																																																																																																																																
50	15/07/23	ISSUED AS PER COMMENTS																																																																																																																																																																																																																																																																																																																
51	15/07/23	ISSUED AS PER COMMENTS																																																																																																																																																																																																																																																																																																																
52	15/07/23	ISSUED AS PER COMMENTS																																																																																																																																																																																																																																																																																																																
53	15/07/23	ISSUED AS PER COMMENTS																																																																																																																																																																																																																																																																																																																
54	15/07/23	ISSUED AS PER COMMENTS																																																																																																																																																																																																																																																																																																																
55	15/07/23	ISSUED AS PER COMMENTS																																																																																																																																																																																																																																																																																																																
56	15/07/23	ISSUED AS PER COMMENTS																																																																																																																																																																																																																																																																																																																
57	15/07/23	ISSUED AS PER COMMENTS																																																																																																																																																																																																																																																																																																																
58	15/07/23	ISSUED AS PER COMMENTS																																																																																																																																																																																																																																																																																																																
59	15/07/23	ISSUED AS PER COMMENTS																																																																																																																																																																																																																																																																																																																
60	15/07/23	ISSUED AS PER COMMENTS																																																																																																																																																																																																																																																																																																																
61	15/07/23	ISSUED AS PER COMMENTS																																																																																																																																																																																																																																																																																																																
62	15/07/23	ISSUED AS PER COMMENTS																																																																																																																																																																																																																																																																																																																
63	15/07/23	ISSUED AS PER COMMENTS																																																																																																																																																																																																																																																																																																																
64	15/07/23	ISSUED AS PER COMMENTS																																																																																																																																																																																																																																																																																																																
65	15/07/23	ISSUED AS PER COMMENTS																																																																																																																																																																																																																																																																																																																
66	15/07/23	ISSUED AS PER COMMENTS																																																																																																																																																																																																																																																																																																																
67	15/07/23	ISSUED AS PER COMMENTS																																																																																																																																																																																																																																																																																																																
68	15/07/23	ISSUED AS PER COMMENTS																																																																																																																																																																																																																																																																																																																
69	15/07/23	ISSUED AS PER COMMENTS																																																																																																																																																																																																																																																																																																																
70	15/07/23	ISSUED AS PER COMMENTS																																																																																																																																																																																																																																																																																																																
71	15/07/23	ISSUED AS PER COMMENTS																																																																																																																																																																																																																																																																																																																
72	15/07/23	ISSUED AS PER COMMENTS																																																																																																																																																																																																																																																																																																																
73	15/07/23	ISSUED AS PER COMMENTS																																																																																																																																																																																																																																																																																																																
74	15/07/23	ISSUED AS PER COMMENTS																																																																																																																																																																																																																																																																																																																
75	15/07/23	ISSUED AS PER COMMENTS																																																																																																																																																																																																																																																																																																																
76	15/07/23	ISSUED AS PER COMMENTS																																																																																																																																																																																																																																																																																																																
77	15/07/23	ISSUED AS PER COMMENTS																																																																																																																																																																																																																																																																																																																
78	15/07/23	ISSUED AS PER COMMENTS																																																																																																																																																																																																																																																																																																																
79	15/07/23	ISSUED AS PER COMMENTS																																																																																																																																																																																																																																																																																																																
80	15/07/23	ISSUED AS PER COMMENTS																																																																																																																																																																																																																																																																																																																
81	15/07/23	ISSUED AS PER COMMENTS																																																																																																																																																																																																																																																																																																																
82	15/07/23	ISSUED AS PER COMMENTS																																																																																																																																																																																																																																																																																																																
83	15/07/23	ISSUED AS PER COMMENTS																																																																																																																																																																																																																																																																																																																
84	15/07/23	ISSUED AS PER COMMENTS																																																																																																																																																																																																																																																																																																																
85	15/07/23	ISSUED AS PER COMMENTS																																																																																																																																																																																																																																																																																																																
86	15/07/23	ISSUED AS PER COMMENTS																																																																																																																																																																																																																																																																																																																
87	15/07/23	ISSUED AS PER COMMENTS																																																																																																																																																																																																																																																																																																																
88	15/07/23	ISSUED AS PER COMMENTS																																																																																																																																																																																																																																																																																																																
89	15/07/23	ISSUED AS PER COMMENTS																																																																																																																																																																																																																																																																																																																
90	15/07/23	ISSUED AS PER COMMENTS																																																																																																																																																																																																																																																																																																																
91	15/07/23	ISSUED AS PER COMMENTS																																																																																																																																																																																																																																																																																																																
92	15/07/23	ISSUED AS PER COMMENTS																																																																																																																																																																																																																																																																																																																
93	15/07/23	ISSUED AS PER COMMENTS																																																																																																																																																																																																																																																																																																																
94	15/07/23	ISSUED AS PER COMMENTS																																																																																																																																																																																																																																																																																																																
95	15/07/23	ISSUED AS PER COMMENTS																																																																																																																																																																																																																																																																																																																
96	15/07/23	ISSUED AS PER COMMENTS																																																																																																																																																																																																																																																																																																																
97	15/07/23	ISSUED AS PER COMMENTS																																																																																																																																																																																																																																																																																																																
98	15/07/23	ISSUED AS PER COMMENTS																																																																																																																																																																																																																																																																																																																
99	15/07/23	ISSUED AS PER COMMENTS																																																																																																																																																																																																																																																																																																																
100	15/07/23	ISSUED AS PER COMMENTS																																																																																																																																																																																																																																																																																																																
TITLE : PENTHOUSE FLOOR PARTIAL ELEVATION & SECTION, PLAN FOR CURTAIN WALL (TOWER 3)		DATE : 22-07-23 SCALE : 1:50(A1) DRAWN BY : CHECKED BY : MIDI Architecture 10/F, 1000000000 (香港) 中環皇后大道中 TEL: (852) 21221666 FAX: (852) 21221666																																																																																																																																																																																																																																																																																																																
DWG NO. : 4658-CN-PE319 REV. : E																																																																																																																																																																																																																																																																																																																		

T3

T3 BA

T3 BB

T3 BC

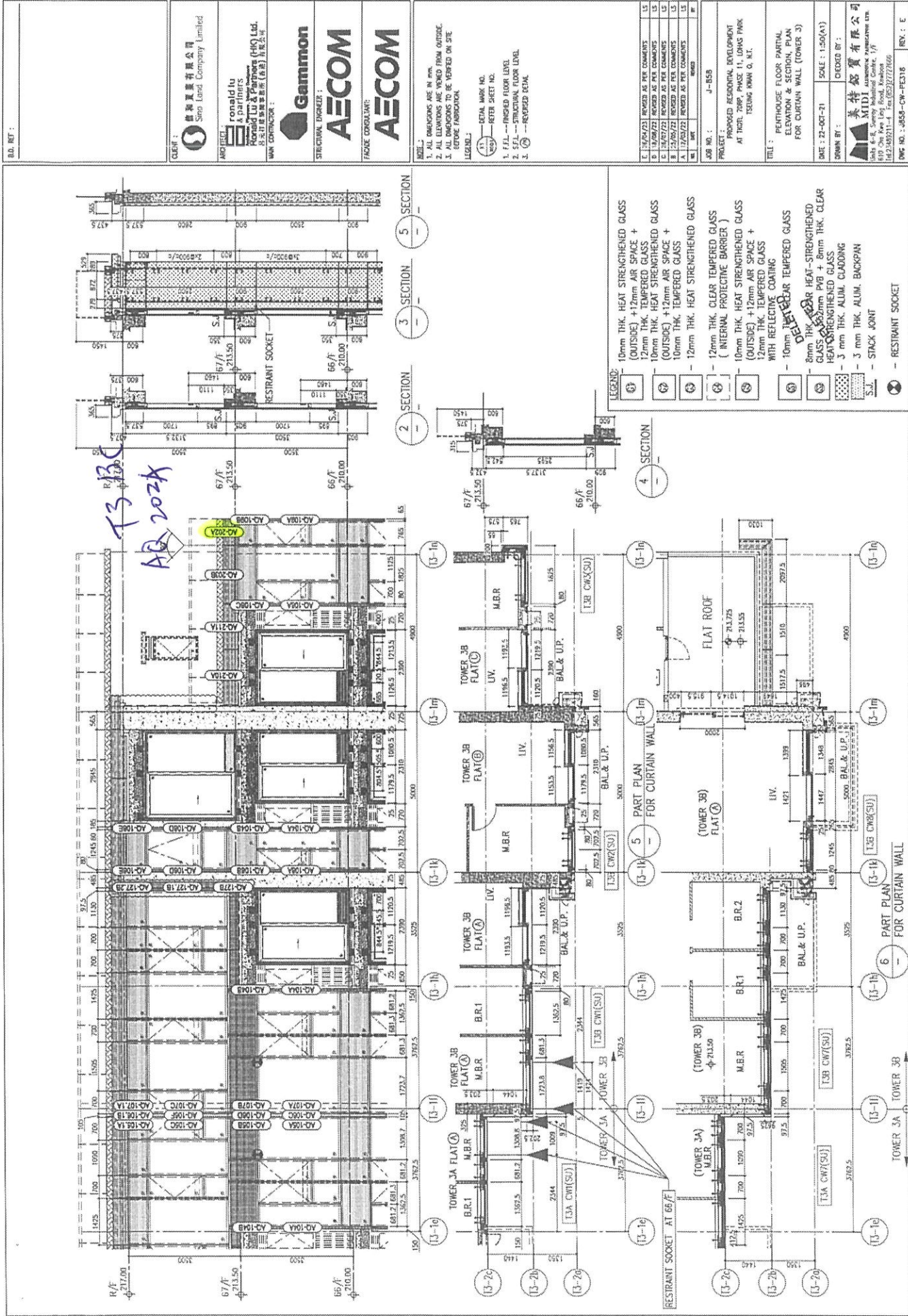

B.D. REF:

CLIENT: Sino Land Company Limited

ARCHITECT: ronald lu & partners
 11/F, 110, Queen's Road East, Hong Kong
 香港皇后大道東110號11樓

MAIN CONTRACTOR: Gammon

STRUCTURAL ENGINEER: AECOM

FAÇADE CONSULTANT: AECOM

- NOTE:
1. ALL DIMENSIONS ARE IN mm.
 2. ALL WORKING ARE TO BE CHECKED FROM OUTSIDE.
 3. ALL MATERIALS TO BE TESTED ON SITE.
 4. REFER TO DRAWING FOR FINISHES AND FABRICATION.
- LEGEND:
1. F.F.L. -- FINISHED FLOOR LEVEL
 2. S.F.L. -- STRUCTURAL FLOOR LEVEL
 3. -- REPOSED DECK

U	1.20x2.10	WINDOWS AS PER COMMENTS	U3
E	1.80x2.70	WINDOWS AS PER COMMENTS	U2
E	2.40x3.20	WINDOWS AS PER COMMENTS	U1
A	1.70x2.10	WINDOWS AS PER COMMENTS	U5
A	2.10x2.10	WINDOWS AS PER COMMENTS	U4
W	2.10x2.10	WINDOWS AS PER COMMENTS	W

JOB NO.: J-858
 PROJECT: REPOSED RESIDENTIAL DEVELOPMENT AT PHASE 2B, PHASE 11, LOMA PARK USING 999W Q. K.T.

TITLE: PENTHOUSE FLOOR PARTIAL ELEVATION & SECTION, PLAN FOR CURTAIN WALL (TOWER 3)

DESIGN BY: MIDITECH
 DATE: 22-06-21
 SCALE: 1:50(A1)

DRAWN BY: MIDITECH
 CHECKED BY: MIDITECH

PROJECT MANAGER: MIDITECH
 MIDITECH (HONG KONG) LTD.
 11/F, 110, Queen's Road East, Hong Kong
 112,240,971-1, Fax: (852) 2777668

REV.: E
 DWG NO.: 858-CW-FE316

- LEGEND:
- ① 10mm THK. HEAT STRENGTHENED GLASS (OUTSIDE) + 12mm AIR SPACE + 12mm THK. CLEAR TEMPERED GLASS
 - ② 10mm THK. HEAT STRENGTHENED GLASS (OUTSIDE) + 12mm AIR SPACE + 10mm THK. HEAT STRENGTHENED GLASS
 - ③ 12mm THK. HEAT STRENGTHENED GLASS
 - ④ 12mm THK. CLEAR TEMPERED GLASS (INTERNAL PROTECTIVE BARRIER)
 - ⑤ 10mm THK. HEAT STRENGTHENED GLASS (OUTSIDE) + 12mm AIR SPACE + 12mm THK. CLEAR TEMPERED GLASS WITH REFLECTIVE COATING
 - ⑥ 10mm THK. HEAT STRENGTHENED GLASS WITH REFLECTIVE COATING
 - ⑦ 8mm THK. CLEAR TEMPERED GLASS + 8mm THK. CLEAR TEMPERED GLASS + 8mm THK. CLEAR HEAT STRENGTHENED GLASS
 - ⑧ 3 mm THK. ALUM. GLASSING
 - ⑨ 3 mm THK. ALUM. BACKPAN
 - ⑩ STACK JOINT
 - ⑪ RESTRAINT SOCKET

T3

T3 AG

T3 AF

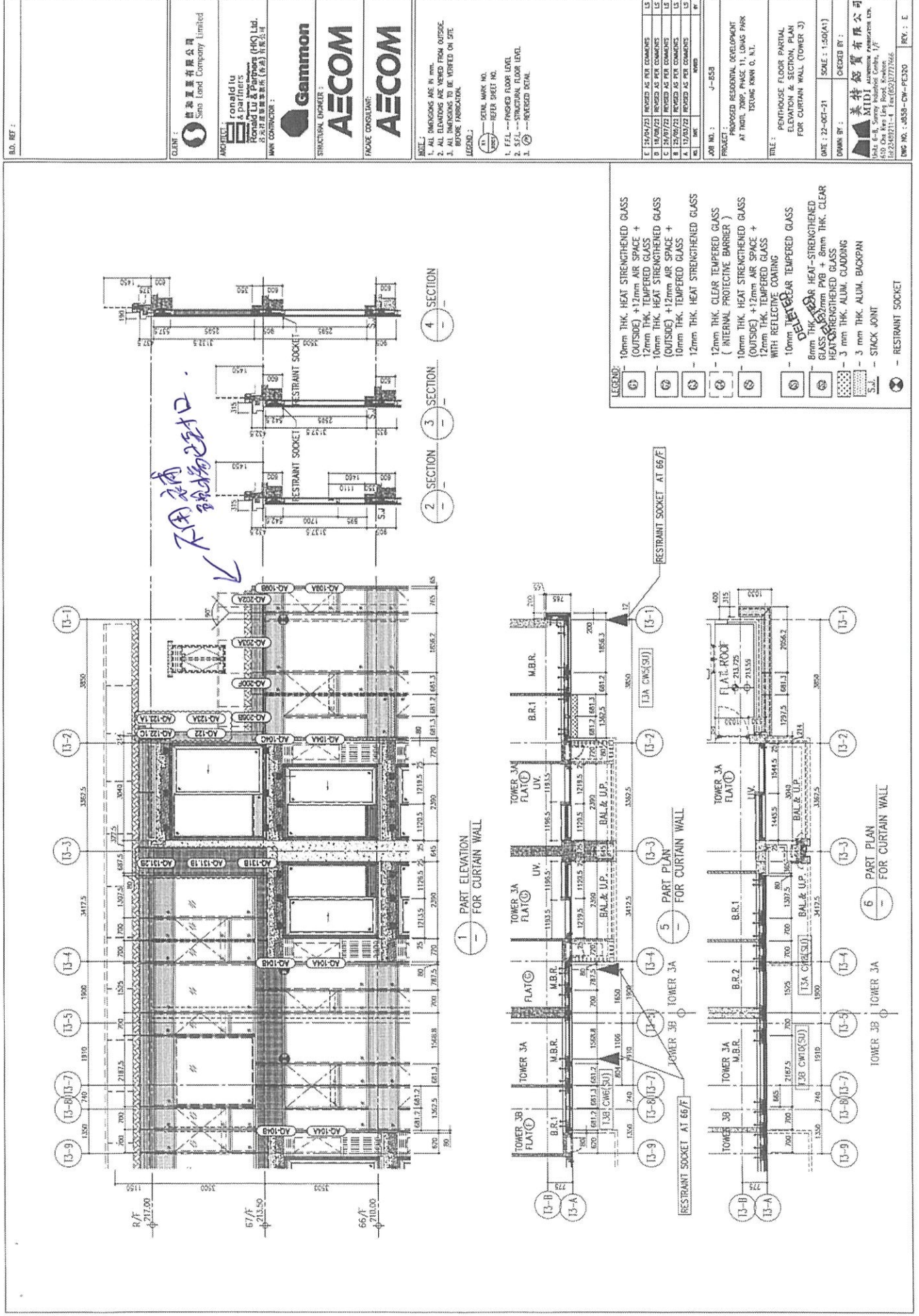

不用玻璃
玻璃已出口

73

依紅方格內為一扎

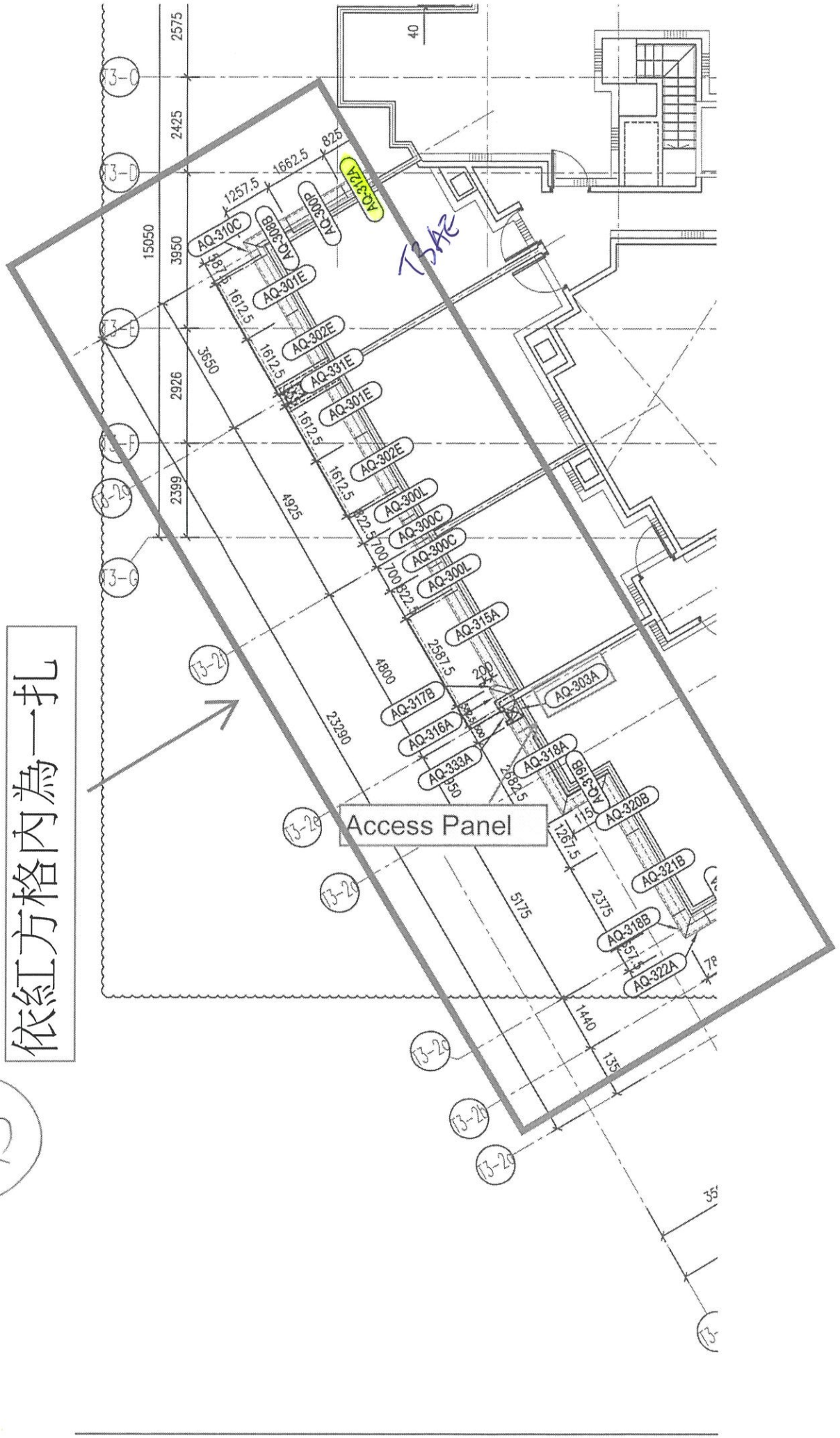

← Sino Kenny 2
昨日 10:38



AR120.1

@jason leung T3-67BB有冇料



← 回覆

依紅方格內為一扎

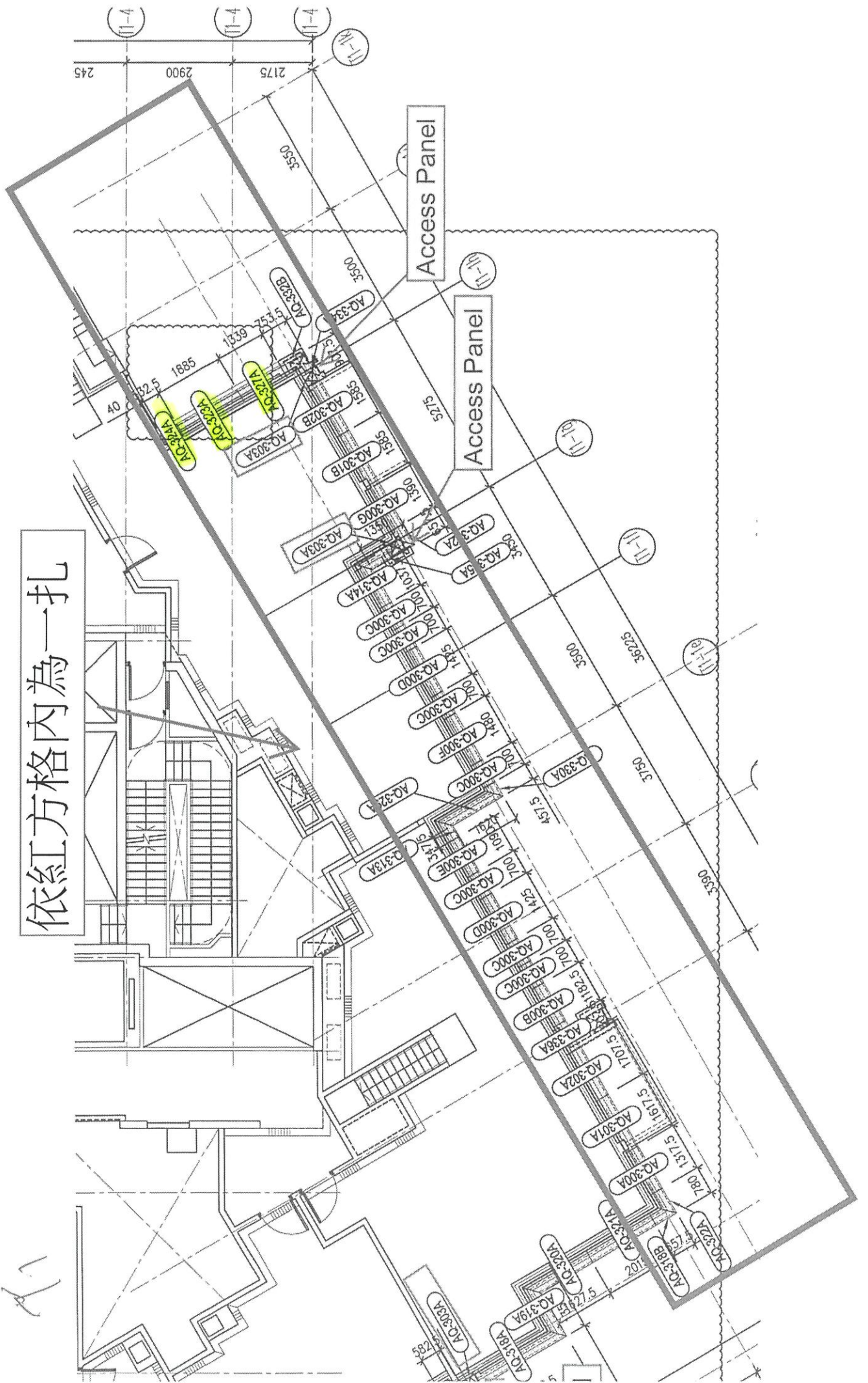

← Sino Kenny 2
33 分鐘前



@jason leung T1-62BA-鵝頭Cladding 幾時
有？



← 回覆

