

工程指示 / 要求簡箋(E.I.)

工程指示編號：EI / 8990 / 25 修改版次：  
 工程編號：J - 858 工程名稱：將軍澳日出康城  
 工程項目：幕牆 第 4 次 補玻璃 69 件 (小業主單)  
 收件人：Maggie 發件人：Jason 日期：20/06/2025

要求提供 / 確認 事項：

- |                                    |                                     |                               |
|------------------------------------|-------------------------------------|-------------------------------|
| <input type="checkbox"/> 初步鋁料 B.M. | <input type="checkbox"/> 加工拆圖，然後生產  | <input type="checkbox"/> 尺寸表  |
| <input type="checkbox"/> 正式鋁料 B.M. | <input type="checkbox"/> 技術上資料 / 指示 | <input type="checkbox"/> 報價   |
| <input type="checkbox"/> 配件 B.M.   | <input type="checkbox"/> 樣辦或貨品說明書   | <input type="checkbox"/> 分判合約 |

內容：

由於地盤需要更換玻璃，請按玻璃 BM 生產玻璃，共 69 件 送地盤。  
請安排熱浸

序號 166, 192 屬玻璃廠品質不合格，需補回

1. 不要印上熱浸標籤。只給”可移除”的標籤。
2. 依原 EI 4867, EI 4943, EI 4942 尺寸補，
3. \*\*\*\*\*分座包箱，玻璃標籤請註明樓層、單位。\*\*\*\*\* 請留意。
4. 第一次補 25 件 EI8938; 第 2 次補 35 件 EI8952; 第 3 次補 23 件 EI8974;; 第 4 次補 69 件  
本次
5. 地盆：更換幕牆玻璃，需用吊船。
6. 按芳姐 二寶 資料

謝謝

請在 2025. 07.19 前完成上列要求。

分發東莞各部門：

- |                                 |                              |                                |                              |                               |                              |                                |                              |
|---------------------------------|------------------------------|--------------------------------|------------------------------|-------------------------------|------------------------------|--------------------------------|------------------------------|
| <input type="checkbox"/> 生產技術總監 | <input type="checkbox"/> 連附件 | <input type="checkbox"/> 技術部   | <input type="checkbox"/> 連附件 | <input type="checkbox"/> 生產部  | <input type="checkbox"/> 連附件 | <input type="checkbox"/> 機械設計部 | <input type="checkbox"/> 連附件 |
| <input type="checkbox"/> 採購部    | <input type="checkbox"/> 連附件 | <input type="checkbox"/> 生產統籌部 | <input type="checkbox"/> 連附件 | <input type="checkbox"/> 小羅&清 | <input type="checkbox"/> 連附件 |                                |                              |
| <input type="checkbox"/> 質檢部    | <input type="checkbox"/> 連附件 | <input type="checkbox"/> 會計部   | <input type="checkbox"/> 連附件 | <input type="checkbox"/> 報關組  | <input type="checkbox"/> 連附件 | <input type="checkbox"/> 其他    | <input type="checkbox"/> 連附件 |

分發香港各部門：

- |   |   |                               |                              |                              |                              |  |   |
|---|---|-------------------------------|------------------------------|------------------------------|------------------------------|--|---|
| <input type="checkbox"/> 行政部            | <input type="checkbox"/> 連附件            | <input type="checkbox"/> 會計部  | <input type="checkbox"/> 連附件 | <input type="checkbox"/> 統籌部 | <input type="checkbox"/> 連附件 | <input checked="" type="checkbox"/> 工程部地盤科文 二寶 | <input checked="" type="checkbox"/> 連附件 |
| <input checked="" type="checkbox"/> 採購部 | <input checked="" type="checkbox"/> 連附件 | <input type="checkbox"/> QS 部 | <input type="checkbox"/> 連附件 | <input type="checkbox"/> 維修部 | <input type="checkbox"/> 連附件 | <input type="checkbox"/> 其他                    | <input type="checkbox"/> 連附件            |

傳遞編號：

HK / 25

發件人簽署：

項目經理簽署：

| 序號  | 位     | 項目        | 座  | 樓層   | 單位 | 作數 | 玻璃面積    | W (mm) | H (mm) | 厚度 (mm) | Letter   |
|-----|-------|-----------|----|------|----|----|---------|--------|--------|---------|--|
| 147 |       | 20/6/小業主單 | T1 | 59/F | AC | 1  | GL01-29 | 1544   | 2332   | 2332    | 主房大壁<br><small>Show THE HEAT STRENGTHEN GLASS (CONTAINED IN LAMINATE COATING ON SURFACE (TEMPERED OR ANNEALED)) 101 (PER 2020/14/09)</small>   |
| 148 |       | 20/6/小業主單 | T1 | 57/F | BC | 1  | GL01-14 | 644    | 2332   | 2332    | 房1大壁<br><small>Show THE HEAT STRENGTHEN GLASS (CONTAINED IN LAMINATE COATING ON SURFACE (TEMPERED OR ANNEALED)) 101 (PER 2020/14/09)</small>   |
| 149 |       | 20/6/小業主單 | T1 | 56/F | BD | 1  | GL02-03 | 663    | 1443   | 1443    | 主正面生窗<br><small>Show THE HEAT STRENGTHEN GLASS (CONTAINED IN LAMINATE COATING ON SURFACE (TEMPERED OR ANNEALED)) 101 (PER 2020/14/09)</small>  |
| 150 |       | 20/6/小業主單 | T1 | 55/F | AC | 1  | GL01-14 | 644    | 2332   | 2332    | 房1大壁<br><small>Show THE HEAT STRENGTHEN GLASS (CONTAINED IN LAMINATE COATING ON SURFACE (TEMPERED OR ANNEALED)) 101 (PER 2020/14/09)</small>   |
| 151 |       | 20/6/小業主單 | T1 | 53/F | BC | 1  | GL01-03 | 644    | 832    | 832     | 主正面上下壁<br><small>Show THE HEAT STRENGTHEN GLASS (CONTAINED IN LAMINATE COATING ON SURFACE (TEMPERED OR ANNEALED)) 101 (PER 2020/14/09)</small> |
| 152 |       | 20/6/小業主單 | T1 | 50/F | BD | 1  | GL01-23 | 1388   | 2332   | 2332    | 房1大壁<br><small>Show THE HEAT STRENGTHEN GLASS (CONTAINED IN LAMINATE COATING ON SURFACE (TEMPERED OR ANNEALED)) 101 (PER 2020/14/09)</small>   |
| 153 |       | 20/6/小業主單 | T1 | 49/F | AE | 1  | GL01-14 | 644    | 2332   | 2332    | 房1大壁<br><small>Show THE HEAT STRENGTHEN GLASS (CONTAINED IN LAMINATE COATING ON SURFACE (TEMPERED OR ANNEALED)) 101 (PER 2020/14/09)</small>   |
| 154 |       | 20/6/小業主單 | T1 | 49/F | AF | 1  | GL01-14 | 644    | 2332   | 2332    | 房1大壁<br><small>Show THE HEAT STRENGTHEN GLASS (CONTAINED IN LAMINATE COATING ON SURFACE (TEMPERED OR ANNEALED)) 101 (PER 2020/14/09)</small>   |
| 155 |       | 20/6/小業主單 | T1 | 48/F | AA | 1  | GL02-05 | 636    | 1443   | 1443    | 主生窗<br><small>Show THE HEAT STRENGTHEN GLASS (CONTAINED IN LAMINATE COATING ON SURFACE (TEMPERED OR ANNEALED)) 101 (PER 2020/14/09)</small>    |
| 156 | 02單   | 20/6/小業主單 | T1 | 48/F | BD | 1  | GL02-12 | 655.5  | 1443   | 1443    | 房2生窗<br><small>Show THE HEAT STRENGTHEN GLASS (CONTAINED IN LAMINATE COATING ON SURFACE (TEMPERED OR ANNEALED)) 101 (PER 2020/14/09)</small>   |
| 157 |       | 20/6/小業主單 | T1 | 47/F | AF | 1  | GL01-14 | 644    | 2332   | 2332    | 房1大壁<br><small>Show THE HEAT STRENGTHEN GLASS (CONTAINED IN LAMINATE COATING ON SURFACE (TEMPERED OR ANNEALED)) 101 (PER 2020/14/09)</small>   |
| 158 |       | 20/6/小業主單 | T1 | 46/F | BC | 1  | GL01-05 | 678.5  | 832    | 832     | 轉角生下壁<br><small>Show THE HEAT STRENGTHEN GLASS (CONTAINED IN LAMINATE COATING ON SURFACE (TEMPERED OR ANNEALED)) 101 (PER 2020/14/09)</small>  |
| 159 |       | 20/6/小業主單 | T1 | 45/F | AC | 1  | GL02-05 | 636    | 1443   | 1443    | 房生窗<br><small>Show THE HEAT STRENGTHEN GLASS (CONTAINED IN LAMINATE COATING ON SURFACE (TEMPERED OR ANNEALED)) 101 (PER 2020/14/09)</small>    |
| 160 |       | 20/6/小業主單 | T1 | 45/F | AF | 1  | GL02-05 | 636    | 1443   | 1443    | 房生窗<br><small>Show THE HEAT STRENGTHEN GLASS (CONTAINED IN LAMINATE COATING ON SURFACE (TEMPERED OR ANNEALED)) 101 (PER 2020/14/09)</small>    |
| 161 |       | 20/6/小業主單 | T1 | 43/F | BC | 1  | GL02-08 | 655.5  | 1443   | 1443    | 主轉角生窗<br><small>Show THE HEAT STRENGTHEN GLASS (CONTAINED IN LAMINATE COATING ON SURFACE (TEMPERED OR ANNEALED)) 101 (PER 2020/14/09)</small>  |
| 162 |       | 20/6/小業主單 | T1 | 42/F | BC | 1  | GL02-05 | 636    | 1443   | 1443    | 房1生窗<br><small>Show THE HEAT STRENGTHEN GLASS (CONTAINED IN LAMINATE COATING ON SURFACE (TEMPERED OR ANNEALED)) 101 (PER 2020/14/09)</small>   |
| 163 |       | 20/6/小業主單 | T1 | 41/F | AA | 1  | GL01-03 | 644    | 832    | 832     | 主生下壁<br><small>Show THE HEAT STRENGTHEN GLASS (CONTAINED IN LAMINATE COATING ON SURFACE (TEMPERED OR ANNEALED)) 101 (PER 2020/14/09)</small>   |
| 164 |       | 20/6/小業主單 | T1 | 41/F | AA | 1  | GL02-05 | 636    | 1443   | 1443    | 房生窗<br><small>Show THE HEAT STRENGTHEN GLASS (CONTAINED IN LAMINATE COATING ON SURFACE (TEMPERED OR ANNEALED)) 101 (PER 2020/14/09)</small>    |
| 165 |       | 20/6/小業主單 | T1 | 39/F | AE | 1  | GL01-54 | 713    | X 2332 | X 2332  | 主房側大壁<br><small>Show THE HEAT STRENGTHEN GLASS (CONTAINED IN LAMINATE COATING ON SURFACE (TEMPERED OR ANNEALED)) 101 (PER 2020/14/09)</small>  |
| 166 | 中空內黃色 | 20/6/小業主單 | T1 | 39/F | AE | 1  | GL01-27 | 1660   | 2332   | 2332    | 主房大壁<br><small>Show THE HEAT STRENGTHEN GLASS (CONTAINED IN LAMINATE COATING ON SURFACE (TEMPERED OR ANNEALED)) 101 (PER 2020/14/09)</small>   |
| 167 |       | 20/6/小業主單 | T1 | 39/F | AE | 1  | GL02-05 | 636    | 1443   | 1443    | 房1生窗<br><small>Show THE HEAT STRENGTHEN GLASS (CONTAINED IN LAMINATE COATING ON SURFACE (TEMPERED OR ANNEALED)) 101 (PER 2020/14/09)</small>   |
| 168 |       | 20/6/小業主單 | T1 | 39/F | BD | 1  | GL02-08 | 655.5  | 1443   | 1443    | 主轉角生窗<br><small>Show THE HEAT STRENGTHEN GLASS (CONTAINED IN LAMINATE COATING ON SURFACE (TEMPERED OR ANNEALED)) 101 (PER 2020/14/09)</small>  |
| 169 |       | 20/6/小業主單 | T1 | 37/F | BC | 1  | GL01-14 | 644    | 2332   | 2332    | 房1大壁<br><small>Show THE HEAT STRENGTHEN GLASS (CONTAINED IN LAMINATE COATING ON SURFACE (TEMPERED OR ANNEALED)) 101 (PER 2020/14/09)</small>   |
| 170 |       | 20/6/小業主單 | T1 | 36/F | AE | 1  | GL01-54 | 713    | X 2332 | X 2332  | 主房側大壁<br><small>Show THE HEAT STRENGTHEN GLASS (CONTAINED IN LAMINATE COATING ON SURFACE (TEMPERED OR ANNEALED)) 101 (PER 2020/14/09)</small>  |
| 171 |       | 20/6/小業主單 | T1 | 36/F | AE | 1  | GL01-53 | 513    | X 832  | X 832   | 主房側生下壁<br><small>Show THE HEAT STRENGTHEN GLASS (CONTAINED IN LAMINATE COATING ON SURFACE (TEMPERED OR ANNEALED)) 101 (PER 2020/14/09)</small> |
| 172 |       | 20/6/小業主單 | T1 | 36/F | AE | 1  | GL01-03 | 644    | 832    | 832     | 主正面上下壁<br><small>Show THE HEAT STRENGTHEN GLASS (CONTAINED IN LAMINATE COATING ON SURFACE (TEMPERED OR ANNEALED)) 101 (PER 2020/14/09)</small> |
| 173 |       | 20/6/小業主單 | T1 | 36/F | BB | 1  | GL01-17 | 585.5  | 2332   | 2332    | 主房大壁<br><small>Show THE HEAT STRENGTHEN GLASS (CONTAINED IN LAMINATE COATING ON SURFACE (TEMPERED OR ANNEALED)) 101 (PER 2020/14/09)</small>   |
| 174 |       | 20/6/小業主單 | T1 | 36/F | AD | 1  | GL01-02 | 663    | 832    | 832     | 主生下壁<br><small>Show THE HEAT STRENGTHEN GLASS (CONTAINED IN LAMINATE COATING ON SURFACE (TEMPERED OR ANNEALED)) 101 (PER 2020/14/09)</small>   |

| 序號  | EI  | 項目 | 座  | 樓層   | 單位 | 戶數 | 影響編號    | W (mm) | H (mm) | 厚度(mm)  | Letter |
|-----|-----|----|----|------|----|----|---------|--------|--------|---|--------|
| 175 |     | CW | T1 | 36/F | BD | 1  | GL01-02 | 663    | 832    | Down THE HEAT STRENGTHEN GLASS (COATED BY LOW-E COATING ON SURFACE) CLEAR TAMPONED GLASS(SHOWER) 10T (E25220114001) |        |
| 176 |     | CW | T1 | 35/F | BA | 1  | GL01-16 | 1662   | 2332   | Down THE HEAT STRENGTHEN GLASS (COATED BY LOW-E COATING ON SURFACE) CLEAR TAMPONED GLASS(SHOWER) 10T (E25220114001) |        |
| 177 |     | CW | T1 | 33/F | AE | 1  | GL02-05 | 636    | 1443   | Down THE HEAT STRENGTHEN GLASS (COATED BY LOW-E COATING ON SURFACE) CLEAR TAMPONED GLASS(SHOWER) 10T (E25220114001) |        |
| 178 |     | CW | T1 | 33/F | BF | 1  | GL01-12 | 663    | 2332   | Down THE HEAT STRENGTHEN GLASS (COATED BY LOW-E COATING ON SURFACE) CLEAR TAMPONED GLASS(SHOWER) 10T (E25220114001) |        |
| 179 |     | CW | T1 | 33/F | BA | 1  | GL02-05 | 636    | 1443   | Down THE HEAT STRENGTHEN GLASS (COATED BY LOW-E COATING ON SURFACE) CLEAR TAMPONED GLASS(SHOWER) 10T (E25220114001) |        |
| 180 |     | CW | T1 | 33/F | BA | 1  | GL01-14 | 644    | 2332   | Down THE HEAT STRENGTHEN GLASS (COATED BY LOW-E COATING ON SURFACE) CLEAR TAMPONED GLASS(SHOWER) 10T (E25220114001) |        |
| 181 | 02單 | CW | T1 | 32/F | AE | 1  | GL02-08 | 655.5  | 1443   | Down THE HEAT STRENGTHEN GLASS (COATED BY LOW-E COATING ON SURFACE) CLEAR TAMPONED GLASS(SHOWER) 10T (E25220114001) |        |
| 182 |     | CW | T1 | 31/F | AE | 1  | GL02-05 | 636    | 1443   | Down THE HEAT STRENGTHEN GLASS (COATED BY LOW-E COATING ON SURFACE) CLEAR TAMPONED GLASS(SHOWER) 10T (E25220114001) |        |
| 183 | 02單 | CW | T1 | 30/F | BB | 1  | GL01-17 | 585.5  | 2332   | Down THE HEAT STRENGTHEN GLASS (COATED BY LOW-E COATING ON SURFACE) CLEAR TAMPONED GLASS(SHOWER) 10T (E25220114001) |        |
| 184 |     | CW | T1 | 30/F | AC | 1  | GL01-03 | 644    | 832    | Down THE HEAT STRENGTHEN GLASS (COATED BY LOW-E COATING ON SURFACE) CLEAR TAMPONED GLASS(SHOWER) 10T (E25220114001) |        |
| 185 |     | CW | T1 | 30/F | AC | 1  | GL01-29 | 1544   | 2332   | Down THE HEAT STRENGTHEN GLASS (COATED BY LOW-E COATING ON SURFACE) CLEAR TAMPONED GLASS(SHOWER) 10T (E25220114001) |        |
| 186 |     | CW | T1 | 28/F | BC | 1  | GL01-05 | 678.5  | 832    | Down THE HEAT STRENGTHEN GLASS (COATED BY LOW-E COATING ON SURFACE) CLEAR TAMPONED GLASS(SHOWER) 10T (E25220114001) |        |
| 187 |     | CW | T1 | 28/F | BC | 1  | GL02-08 | 655.5  | 1443   | Down THE HEAT STRENGTHEN GLASS (COATED BY LOW-E COATING ON SURFACE) CLEAR TAMPONED GLASS(SHOWER) 10T (E25220114001) |        |
| 188 |     | CW | T1 | 27/F | AE | 1  | GL01-15 | 513    | 1443   | Down THE HEAT STRENGTHEN GLASS (COATED BY LOW-E COATING ON SURFACE) CLEAR TAMPONED GLASS(SHOWER) 10T (E25220114001) |        |
| 189 | 02單 | CW | T1 | 27/F | BC | 1  | GL02-05 | 636    | 1443   | Down THE HEAT STRENGTHEN GLASS (COATED BY LOW-E COATING ON SURFACE) CLEAR TAMPONED GLASS(SHOWER) 10T (E25220114001) |        |
| 190 |     | CW | T1 | 26/F | BE | 1  | GL02-07 | 585    | 1443   | Down THE HEAT STRENGTHEN GLASS (COATED BY LOW-E COATING ON SURFACE) CLEAR TAMPONED GLASS(SHOWER) 10T (E25220114001) |        |
| 191 |     | CW | T1 | 22/F | BB | 1  | GL02-07 | 585    | 1443   | Down THE HEAT STRENGTHEN GLASS (COATED BY LOW-E COATING ON SURFACE) CLEAR TAMPONED GLASS(SHOWER) 10T (E25220114001) |        |
| 192 | 自採  | CW | T1 | 20/F | BD | 1  | GL02-08 | 655.5  | 1443   | Down THE HEAT STRENGTHEN GLASS (COATED BY LOW-E COATING ON SURFACE) CLEAR TAMPONED GLASS(SHOWER) 10T (E25220114001) |        |
| 193 |     | CW | T1 | 20/F | BB | 1  | GL01-17 | 585.5  | 2332   | Down THE HEAT STRENGTHEN GLASS (COATED BY LOW-E COATING ON SURFACE) CLEAR TAMPONED GLASS(SHOWER) 10T (E25220114001) |        |
| 194 |     | CW | T1 | 20/F | AA | 1  | GL02-05 | 636    | 1443   | Down THE HEAT STRENGTHEN GLASS (COATED BY LOW-E COATING ON SURFACE) CLEAR TAMPONED GLASS(SHOWER) 10T (E25220114001) |        |
| 195 |     | CW | T1 | 20/F | AA | 1  | GL01-14 | 644    | 2332   | Down THE HEAT STRENGTHEN GLASS (COATED BY LOW-E COATING ON SURFACE) CLEAR TAMPONED GLASS(SHOWER) 10T (E25220114001) |        |
| 196 |     | CW | T1 | 20/F | AF | 1  | GL02-05 | 636    | 1443   | Down THE HEAT STRENGTHEN GLASS (COATED BY LOW-E COATING ON SURFACE) CLEAR TAMPONED GLASS(SHOWER) 10T (E25220114001) |        |
| 197 |     | CW | T1 | 20/F | BC | 1  | GL02-08 | 655.5  | 1443   | Down THE HEAT STRENGTHEN GLASS (COATED BY LOW-E COATING ON SURFACE) CLEAR TAMPONED GLASS(SHOWER) 10T (E25220114001) |        |
| 198 |     | CW | T1 | 19/F | AA | 1  | GL01-03 | 644    | 832    | Down THE HEAT STRENGTHEN GLASS (COATED BY LOW-E COATING ON SURFACE) CLEAR TAMPONED GLASS(SHOWER) 10T (E25220114001) |        |
| 199 |     | CW | T1 | 19/F | AB | 1  | GL02-03 | 663    | 1443   | Down THE HEAT STRENGTHEN GLASS (COATED BY LOW-E COATING ON SURFACE) CLEAR TAMPONED GLASS(SHOWER) 10T (E25220114001) |        |
| 200 |     | CW | T1 | 18/F | AA | 1  | GL01-15 | 1272   | 2332   | Down THE HEAT STRENGTHEN GLASS (COATED BY LOW-E COATING ON SURFACE) CLEAR TAMPONED GLASS(SHOWER) 10T (E25220114001) |        |
| 201 |     | CW | T1 | 18/F | AA | 1  | GL02-05 | 636    | 1443   | Down THE HEAT STRENGTHEN GLASS (COATED BY LOW-E COATING ON SURFACE) CLEAR TAMPONED GLASS(SHOWER) 10T (E25220114001) |        |
| 202 |     | CW | T1 | 18/F | AA | 1  | GL01-14 | 644    | 2332   | Down THE HEAT STRENGTHEN GLASS (COATED BY LOW-E COATING ON SURFACE) CLEAR TAMPONED GLASS(SHOWER) 10T (E25220114001) |        |



T1 玻璃記錄

地盤名稱：日出康城11期

| 日期      | 座數        | 單位   | 工作範圍        | 內/外  | 分類 |
|---------|-----------|------|-------------|------|----|
| E1 8973 |           | 25BC | 厅梗          | 外崩   | 1  |
|         | A3D 02    | 32BB | 厅梗 ✓        | 內    | 1  |
|         | 02        | 61BC | 厅梗 + 厅门玉    | ✓ 內外 | 2  |
|         | 02 單      | 42BB | 厅梗 ✓        | 內    |    |
|         | 自燃        | 20BD | 主轉角         | 內爆   |    |
|         | 太边        | 12BC | 房1大梗        | 內外   |    |
|         | 太边        | 20BC | 主轉角生窗       |      |    |
|         | 02        | 32AZ | 主轉角         | 哈    |    |
|         | 02        | 27BC | 房1生窗        | 外崩   |    |
|         |           | 58AD | 厅门梗 + 厅门玉 ✓ | 內外   | 2  |
|         | 02 房中空有異色 | 39AZ | 主大梗         |      |    |
|         | 02        | 52AC | 厅梗 ✓        | 內崩   |    |
|         |           | 33BA | 厅门梗 ✓       | 內外   |    |
|         | 太边        | ∪    | 主生窗 ✓       | 內    |    |
|         |           | ∪    | 房1大梗        | 內    |    |
|         | 02-03     | 48BD | 厅梗 ✓        | 外    |    |
|         | -1        | ∪    | 房2生窗        | 外    |    |
|         | 02        | 30BB | 房大梗         | 外崩   |    |
|         |           | 42BC | 房1生窗        | 內    |    |
|         |           | 28BC | 主轉角細梗       | 外崩   |    |
|         |           | ∪    | 厅门玉 ✓       |      |    |

16/8

地盤代表簽名：\_\_\_\_\_

日期：\_\_\_\_\_

T1 玻璃記錄

地盤名稱：日出康城11期

| 日期             | 座數    | 單位   | 工作範圍   | 內/外  | 分類 |
|----------------|-------|------|--------|------|----|
| E18952B        | 大边    | 59AC | 主房大櫃 ✓ | 內    |    |
|                | "     | 57AD | 房細櫃    | 內    |    |
|                | "     | 57BC | 房1大櫃 ✓ | 內    |    |
|                |       | 56BD | 主正面坐窗  | 外筋   |    |
|                |       | 55AC | 房1大櫃 ✓ | 內筋   |    |
|                | 大边    | 55BC | 厅门玉 ✓  | 內外   |    |
| E18943B        | 人为損   | 53BC | 主房正面細櫃 | 外筋   |    |
|                | 人为損   | 52AD | 厅门玉    | 內筋   |    |
| E18943B        | 人为損   | "    | 厅门櫃    | 內外   |    |
|                | 廠     | 51BD | 厅门玉    | 中空影  |    |
|                |       | 49AE | 房1大櫃   | 外筋   |    |
|                |       | 48AA | 主坐窗 ✓  | "    |    |
|                | 人为    | "    | 厅门玉    | 內    |    |
|                | 人为    | "    | 厅门櫃    | 內    |    |
|                |       | 47AF | 房1大櫃 ✓ | 外筋   |    |
|                | 大边    | "    | 厅门玉 ✓  | 內外   | ✓  |
| 不用訂, 18AC已訂(有) |       | 45AC | 房1坐窗 ✓ | 外筋   |    |
|                |       | 45AF | 房1坐窗 ✓ | "    |    |
| E18974         |       | 43BB | 房大櫃    | 內外   |    |
|                | 大边    | 43BC | 主转角坐窗  | 內    |    |
|                | 大边    | 42AE | 厅门玉 ✓  | 內深   |    |
|                |       | 42BC | 房1坐窗   | 外筋   |    |
|                | 人为損   | 41AG | 厅门櫃    | 內外   |    |
|                |       | 41AD | 主細櫃 ✓  | 內筋   |    |
|                |       | "    | 房1坐窗 ✓ | 外筋   |    |
|                | 中空中廠  | 39AE | 厅门及櫃 ✓ | 中空中筋 |    |
|                |       | "    | 主臥大櫃 ✓ | 外筋   |    |
|                | 业主要求換 | "    | 主大櫃 ✓  | 外    |    |
|                |       | "    | 房1坐窗 ✓ | 外    |    |
| E18973         |       | 39AD | 厅门櫃    | 內筋   |    |

地盤代表簽名： \_\_\_\_\_

日期： \_\_\_\_\_

P.1

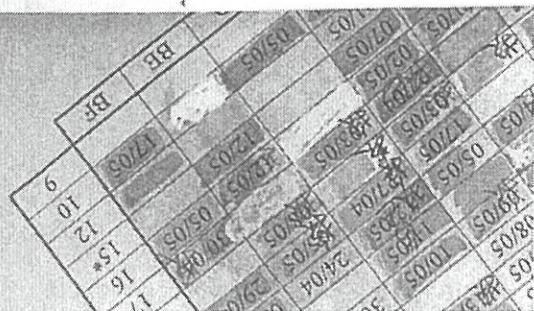

玻璃記錄

盤名稱：日出康城11期

| 日期      | 座數   | 單位            | 工作範圍    | 內/外   | 分類 |
|---------|------|---------------|---------|-------|----|
| E18974  | 大边   | 39BC          | 房1生窗    | 內     |    |
|         |      | 39BD          | 主轉角生窗 ✓ | 外前    |    |
|         |      | 37BC          | 房1大櫃 ✓  | 內     |    |
|         |      | 36BD          | 房細櫃     | 內外    |    |
|         |      | 36AE          | 主則大櫃 ✓  | 外前    |    |
|         |      | ∪             | ∪細櫃 ✓   | 內     |    |
|         |      | ∪             | ∪正面細櫃 ✓ | 內     |    |
|         |      | ∪正面+主則 安全 ✓   |         | 2     |    |
| E18952A | 大边   | 35BA          | 主大櫃     | 內     |    |
|         |      | 33AB          | 主厨生窗    | 內前    |    |
|         |      | ∪             | 厅门柜     | 內外    |    |
|         |      | ∪             | 厅门柜     | 內     |    |
|         |      | 33BF          | 房大櫃 ✓   | 外前    |    |
|         |      | 業主考虑 換不換 33AE | 房1生窗    | 內     |    |
|         |      | 30AA          | 厅门柜     | 外     |    |
| ∪       | 30AC | 厅门柜 ✓         | 外       |       |    |
|         |      | ∪             | 房1細櫃    | ∪     |    |
|         |      | ∪             | 主大櫃     | 外前    |    |
| E18943A |      | 28BD          | 厨       | 外前    |    |
| E18974  | 大边   | 27AD          | 厅门柜 ✓   | 內外    |    |
|         |      | 27AE          | 主轉角生窗   | 外前    |    |
|         |      | ∪             | 主則生窗 ✓  | 內     |    |
|         |      | ∪             | 25AG    | 厅门柜   | 內外 |
|         |      | ∪             | 23AB    | 厅门柜 ✓ | 外  |
|         |      | ∪             | ∪       | 厨 ✓   | 內外 |
|         |      | ∪             | 23BF    | 厅门柜   | 外  |
|         |      | ∪             | ∪       | 厅门柜   | 外  |
| E18974  |      | 22BB          | 房生窗 ✓   | 內前    |    |
|         |      | 20BB          | 房生窗     | 外前    |    |
|         |      | ∪             | ∪大櫃 ✓   | 內前    |    |

地盤代表簽名： \_\_\_\_\_

日期： \_\_\_\_\_



玻璃記錄

名稱：日出康城11期

| 日期      | 座數     | 單位   | 工作範圍    | 內外        | 分類 |
|---------|--------|------|---------|-----------|----|
|         |        | 20AA | 主生窗 ✓   | 外窗        |    |
|         | 廠      | "    | 房大樑 ✓   | 中空光       |    |
|         | "      | "    | 厅门玉 ✓   | 內+起       |    |
|         | "      | "    | 厅门樑 ✓   | 內+起       |    |
|         | "      | 19AA | 厅门玉     | 中空黑色      |    |
|         | "      | "    | 主細樑     | 內         |    |
|         | 大边     | 19AB | 主正面生窗   | 內         |    |
|         | "      | 19AC | 厅门樑 ✓   | 內         |    |
|         |        | 18AA | 主大樑 ✓   | 內窗        |    |
|         | 大边     | "    | 主生窗 ✓   | 內         |    |
|         | "      | "    | 房大樑 ✓   | 內         |    |
|         |        | 18AC | 主大樑     | 外窗        |    |
|         | 大边     | "    | 厅门玉 ✓   | 內外        |    |
|         |        | 18BB | 房大樑 ✓   | 外窗        |    |
|         | 大边     | "    | 主生窗 ✓   | 外         |    |
|         |        | 18BC | 主轉角中窗 ✓ | 內窗        |    |
| E18938A |        | 17AF | 主大樑     | 外窗        |    |
| E18952  |        | "    | 主正面生窗   | "         |    |
|         |        | 16BA | 主大樑 ✓   | 外窗        |    |
|         |        | 16BB | 厅门樑 ✓   | 內外窗       |    |
|         | 大边     | 15AA | 主生窗 ✓   | 內外        |    |
|         |        | 15AE | 主側中窗 ✓  | 內窗        |    |
|         |        | 15AG | 主生窗 ✓   | 外窗        |    |
|         |        | "    | 房細樑 ✓   | 外窗        |    |
|         | 廠 業主更換 | "    | 厅门玉 ✓   | 泡細, 3个没大仔 |    |
|         |        | 15BB | 房大樑 ✓   | 內         |    |
|         |        | "    | 房細樑 ✓   | 內外        |    |
|         |        | "    | 房生窗 ✓   | 外         |    |
|         |        | 10AB | 厨 ✓     | 外         |    |

9/6

地盤代表簽名：\_\_\_\_\_

P.3

日期：\_\_\_\_\_





|    |    |      |                              |
|----|----|------|------------------------------|
| 28 | BD | 厨房   | 飞 8943A                      |
| 27 | AD | 厅门   | 梗                            |
| 27 | AE | 主转角  | 生窗+主则生窗 飞 8974               |
| 27 | AF | 房1   | 生窗 飞 8938A                   |
| 27 | BB | 房    | 生窗 飞 8952                    |
| 26 | AA | 主    | 大梗 飞 8938B                   |
| 26 | BE | 房    | 生窗                           |
| 25 | AG | 厅门   | 梗                            |
| 25 | BC | 厅    | 梗 飞 8973                     |
| 25 | BD | 主    | 大梗(厅门玉+厨房 飞 8973) 飞 8974     |
| 23 | AA | 主    | 安全                           |
| 23 | AB | 厅门   | 梗+厨房                         |
| 23 | BF | 厅门   | 玉+厅门梗 飞 8938A                |
| 22 | AF | 主转角  | 细梗                           |
| 22 | BB | 房    | 生窗 飞 8952                    |
| 22 | BC | 主正面  | 细梗 飞 8973                    |
| 21 | BA | 厅门   | (梗+玉)                        |
| 20 | AA | 主    | 生窗+房1大梗+厅门玉+厅门梗              |
| 20 | AB | 主则   | 大梗 飞 8938                    |
| 20 | BB | 房    | 生窗+房大梗 飞 8974                |
| 20 | AC | 主    | (生窗+房1生窗+房1大梗)(房1细梗 飞 8938A) |
| 20 | AE | 主正面左 | 生窗 飞 8952                    |
| 19 | AA | 厅门   | 玉+主细梗                        |
| 19 | AB | 主正面  | 生窗                           |
| 19 | AC | 厅门   | 梗                            |
| 19 | AF | 主正面  | (生窗+主正面细梗+房1大梗 飞 8974)       |
| 19 | BE | 房    | 大梗 飞 8938B                   |
| 18 | AA | 主    | 大梗+主生窗+房1大梗                  |
| 18 | AC | 主    | 大梗+厅门玉                       |
| 18 | BB | 房    | 大梗+房生窗                       |
| 18 | BC | 主转角  | 生窗                           |
| 18 | BD | 房1   | 生窗                           |
| 18 | BE | 房    | (大梗 飞 8974)                  |

|    |    |    |                          |
|----|----|----|--------------------------|
| 17 | AE | 主  | 大梗+主正面生窗 飞 8974          |
| 17 | AF | 主  | 大梗(主正面生窗 飞 8952) 飞 8938A |
| 17 | AD | 房  | 大梗+厅门玉 飞 8943            |
| 17 | BD | 主  | 大梗 飞 8974                |
| 17 | BF | 厅门 | 玉 飞 8943                 |
| 16 | AB | 主则 | 生窗 飞 8952                |
| 16 | AD | 房  | 生窗 飞 8938B               |
| 16 | BA | 厅门 | 玉+主大梗 飞 8943B            |
| 16 | BB | 厅门 | 梗                        |
| 16 | BE | 厅门 | 玉 飞 8985A                |
| 15 | AA | 主  | 生窗                       |
| 15 | AD | 房  | 大梗+厅门玉                   |
| 15 | AE | 主则 | 生窗                       |
| 15 | AG | 主  | 生窗+房1细梗+厅门玉              |
| 15 | BB | 房  | 大梗+房细梗+房生窗               |
| 12 | AF | 房1 | 房1生窗+厅门梗 飞 8952          |
| 12 | BA | 房  | 生窗 飞 8952B               |
| 10 | AA | 房1 | 大梗 飞 8952B               |
| 10 | AB | 厨房 | 大梗 飞 8896A               |
| 10 | BC | 主  | 大梗                       |

| 编号 | 字母 | 位置   | 施工内容                             |
|----|----|------|----------------------------------|
| 59 | AC | 主房   | 大梗                               |
| 58 | BC | 厅门   | (梗+厅门玉 E18973)                   |
| 57 | AD | 房    | 细梗 (E18952B)                     |
| 57 | BC | 房1   | 大梗                               |
| 56 | BD | 主正面  | 生窗                               |
| 55 | AC | 房1   | 大梗                               |
| 55 | BC | 厅门   | 玉                                |
| 53 | BC | 主房正面 | 细梗                               |
| 52 | AD | 厅门   | (玉+厅门梗 E18943B)                  |
| 51 | AA | 房1   | 细梗 (E18952B)                     |
| 51 | BD | 厅门   | 玉                                |
| 50 | BD | 房1   | 大梗                               |
| 49 | AE | 房1   | 大梗                               |
| 49 | BA | 主    | 细梗 E18974                        |
| 49 | BD | 房2   | 细梗 (厅门玉 E18973) E18974           |
| 48 | AA | 主    | 生窗 (厅门玉+厅门梗 E18985)              |
| 48 | BD | 厨房   | E18973                           |
| 47 | AF | 房1   | 大梗+厅门玉                           |
| 47 | BD | 厨房   | E18943A                          |
| 45 | AC | 房1   | 生窗                               |
| 45 | AF | 房1   | 生窗                               |
| 43 | BB | 房    | 大梗 E18974                        |
| 43 | BC | 主转角  | 生窗                               |
| 43 | BD | 主    | (大梗+主转角生窗 E18952)                |
| 42 | AB | 厅门   | 梗                                |
| 42 | AE | 厅门   | 玉                                |
| 42 | BC | 主转角  | 细梗+房1生窗 E18952B                  |
| 42 | BB | 厅门   | 玉 E18943                         |
| 41 | AA | 主    | 细梗+房1生窗                          |
| 41 | AG | 厅门   | 梗                                |
| 41 | BA | 主    | 生窗 E18974                        |
| 41 | BC | 主    | (大梗+房1细梗 E18938B)                |
| 41 | BD | 房1   | 大梗                               |
| 41 | AE | 房1   | 大梗                               |
| 39 | AG | 房1   | 生窗 E18952                        |
| 39 | AE | 厅门   | 梗+主则大梗+主大梗+房1生窗                  |
| 39 | AD | 厅门   | 梗 E18973                         |
| 39 | BC | 房1   | 生窗 E18974                        |
| 39 | BB | 房    | 生窗 E18952B                       |
| 39 | BD | 主转角  | 生窗                               |
| 37 | AF | 房1   | 细梗 E18938A                       |
| 37 | BC | 房1   | 大梗 E18973                        |
| 37 | BD | 厨房   | E18973                           |
| 36 | AB | 组厨房  | E18973                           |
| 36 | AE | 主则   | 大梗+主则细梗+主正面细梗                    |
| 36 | BB | 房    | 生窗+房大梗 E18952                    |
| 36 | BD | 房    | 细梗                               |
| 35 | AB | 主则   | 大梗 E18952                        |
| 35 | AC | 主    | 大梗 E18938                        |
| 35 | AD | 房    | 细梗 E18952                        |
| 35 | BA | 主    | 大梗                               |
| 33 | AB | 主正面  | (大梗+主则生窗) 厅门玉+厅门梗 E18952A        |
| 33 | AD | 房    | 生窗+房细梗 E18952 E18974             |
| 33 | AE | 房1   | 生窗 (业主考虑换)                       |
| 33 | BF | 房    | 大梗                               |
| 32 | AA | 主    | (大梗+房1大梗) 厅门玉+厅门梗 E18973) E18974 |
| 32 | AE | 房1   | 生窗 E18952A                       |
| 32 | BD | 主正面  | 细梗 E18952                        |
| 30 | AA | 厅门   | 梗                                |
| 30 | AC | 厅门   | 梗+房1细梗+主大梗                       |
| 30 | BE | 房    | 生窗 E18952                        |
| 29 | AF | 主转角  | 生窗 E18938A                       |
| 29 | BD | 房2   | 细梗 E18938                        |
| 29 | BE | 房    | (生窗+细梗 E18952)                   |
| 28 | AC | 主    | (大梗+主细梗+主生窗+) 厅门玉 E18973         |

PROJECT: 康城11期凱柏峰

項目: 鋁窗, 鋁門及幕牆玻璃的驗收表格

TOWER: 1B

樓層: 12/F

單位: C

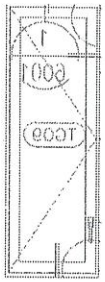
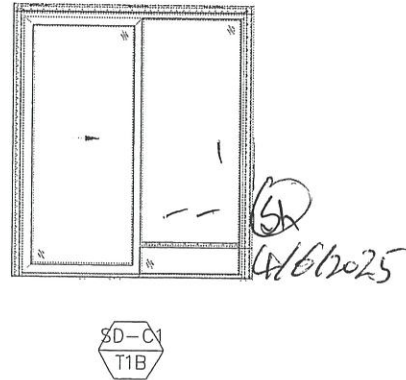
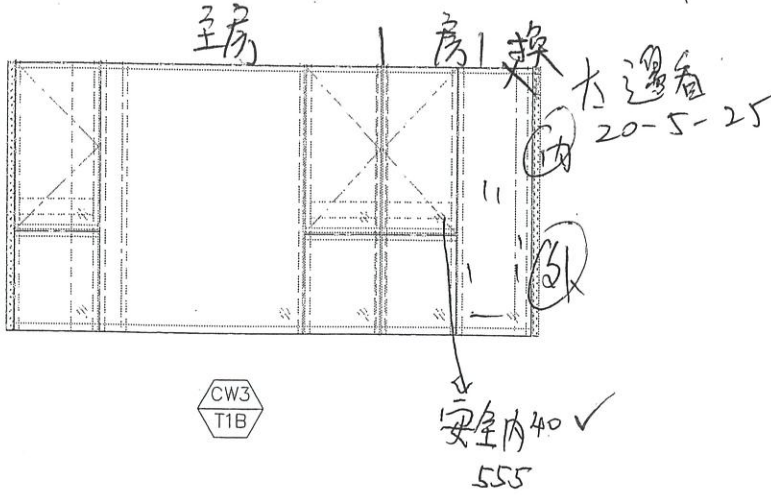

注: 房1待料1

| 公司   | 姓名  | 簽名 | 日期        |
|------|-----|----|-----------|
| MIDI | 盧國深 | ⚡  | 10-5-2025 |
| OSR  |     |    |           |

PROJECT: 康城11期凱柏峰

項目: 鋁窗, 鋁門及幕牆玻璃的驗收表格

TOWER: 1B

樓層:

15

單位: B

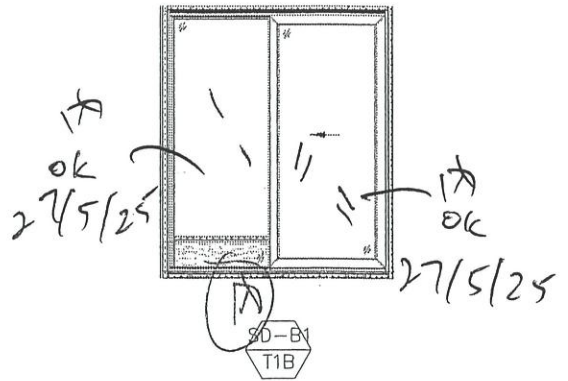
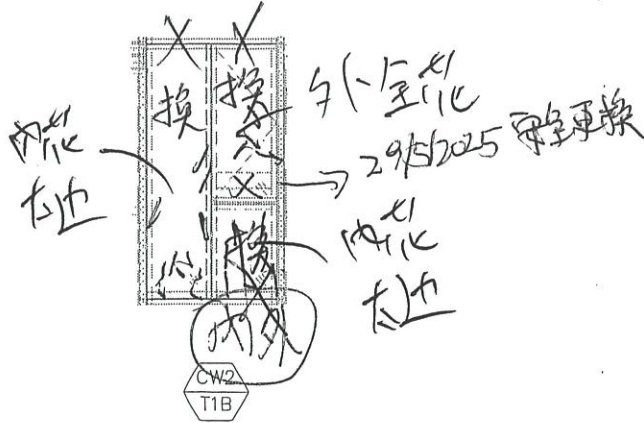

| 表<br>代<br>聯<br>檢 | 公司   | 姓名  | 簽名 | 日期        |
|------------------|------|-----|----|-----------|
|                  | MIDI | 盧國深 | ↳  | 2025-5-24 |
|                  | OSR  |     |    |           |

PROJECT: 康城11期凱柏峰

項目: 鋁窗, 鋁門及幕牆玻璃的驗收表格

TOWER: 1A

樓層: 15

打作中  
單位: G

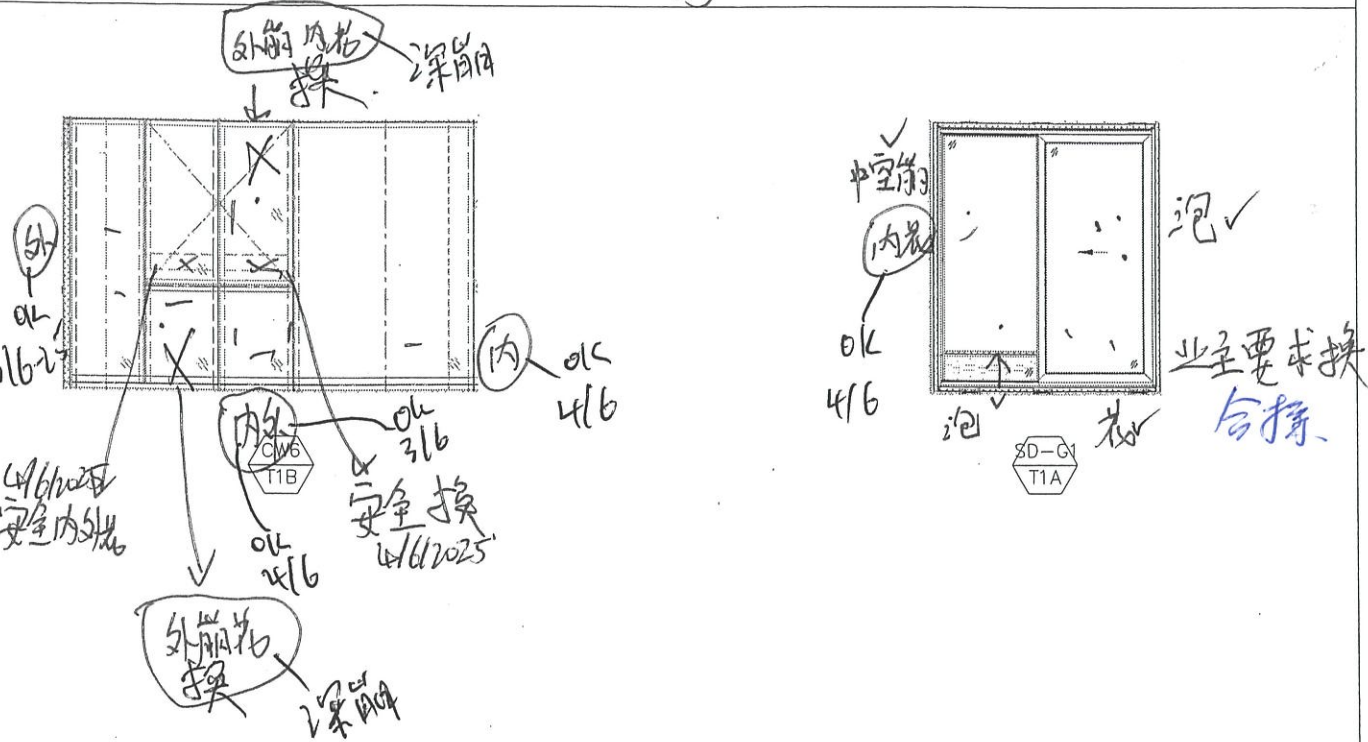

| 聯檢代表 | 公司   | 姓名  | 簽名 | 日期        |
|------|------|-----|----|-----------|
|      | MIDI | 盧國深 | ☞  | 21/6/2025 |
|      | OSR  |     |    |           |



美特鋁質有限公司  
MIDI ALUMINIUM FABRICATOR LTD.

PROJECT: 康城11期凱柏峰

項目: 鋁窗, 鋁門及幕牆玻璃的驗收表格

TOWER: 1A

樓層:

15

單位: E

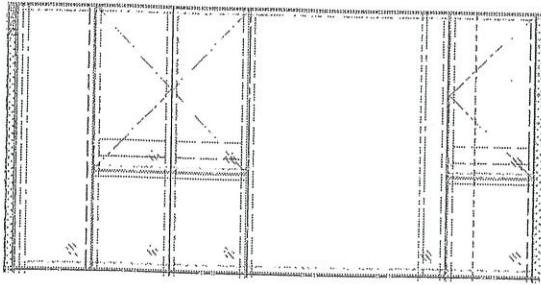

CW4  
T1A

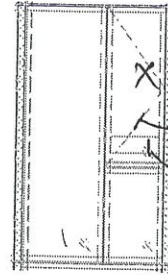

CW4  
T1A

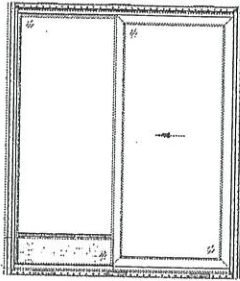

SD-EV  
T1A



B1  
T1A-E

| 聯檢代表 | 公司   | 姓名  | 簽名 | 日期        |
|------|------|-----|----|-----------|
|      | MIDI | 盧國深 | ✓  | 2025-5-24 |
|      | OSR  |     |    |           |

PROJECT: 康城11期凱柏峰

項目: 鋁窗, 鋁門及幕牆玻璃的驗收表格

TOWER: 1A 4/6 樓層: 15 單位: A

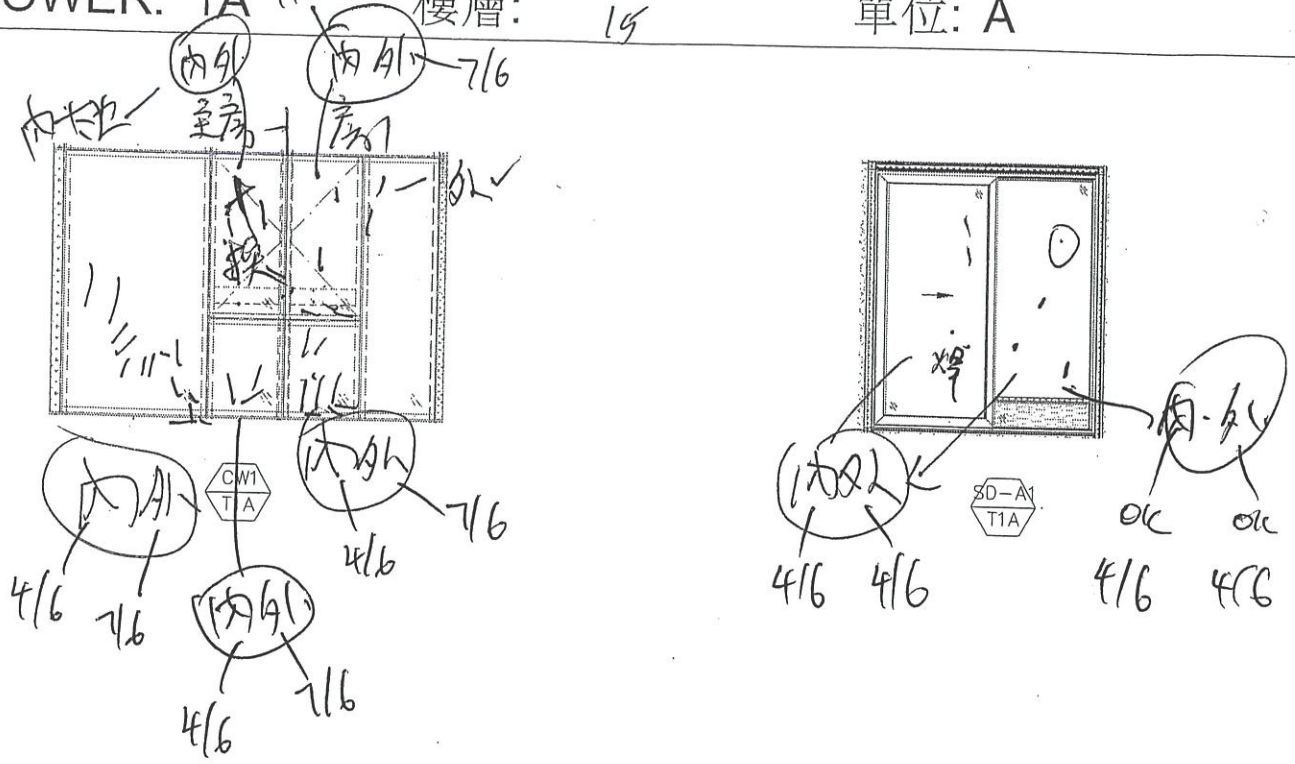

聯檢代表

| 公司   | 姓名  | 簽名 | 日期        |
|------|-----|----|-----------|
| MIDI | 盧國深 | ✓  | 2025-5-23 |
| OSR  |     |    |           |

PROJECT: 康城11期凱柏峰

項目: 鋁窗, 鋁門及幕牆玻璃的驗收表格

TOWER: 1B

樓層: 16

單位: A

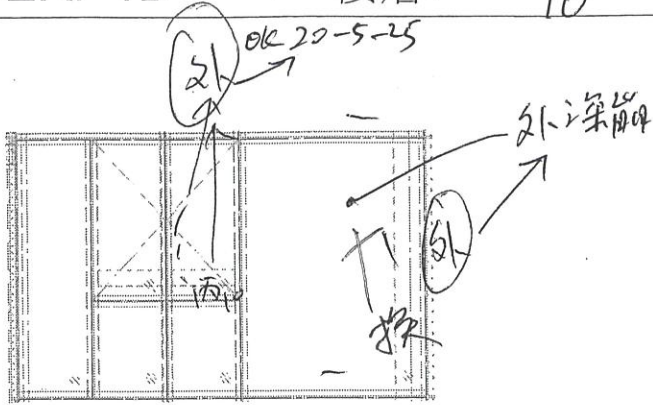

CW1  
T1B

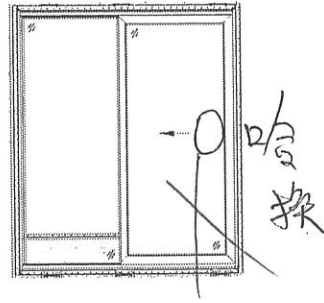

SD-A1  
T1B

| 聯機代衣 | 公司   | 姓名  | 簽名 | 日期        |
|------|------|-----|----|-----------|
|      | MIDI | 盧國深 | ✓  | 13-5-2025 |
|      | OSR  |     |    |           |

PROJECT: 康城11期凱柏峰

項目: 鋁窗, 鋁門及幕牆玻璃的驗收表格

TOWER: 1B 樓層: 18

單位: C

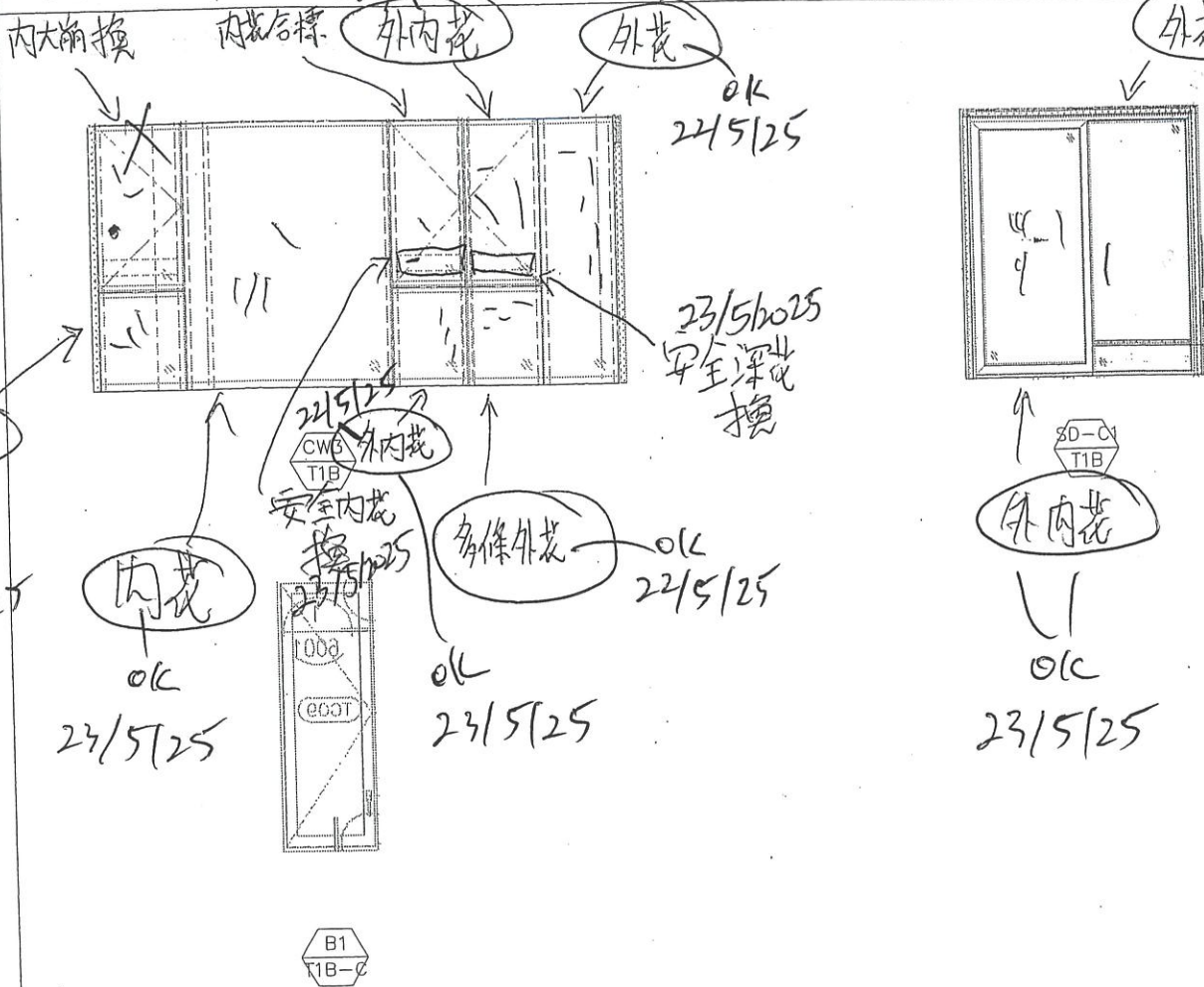

| 聯檢代表 | 公司   | 姓名  | 簽名 | 日期        |
|------|------|-----|----|-----------|
|      | MIDI | 盧國深 | ⚡  | 17-5-2025 |
|      | OSR  |     |    |           |



美特鋁質有限公司  
MIDI ALUMINIUM FABRICATOR LTD.

PROJECT: 康城11期凱柏峰

項目: 鋁窗, 鋁門及幕牆玻璃的驗收表格 打作中

TOWER: 1B

樓層: 18

單位: B

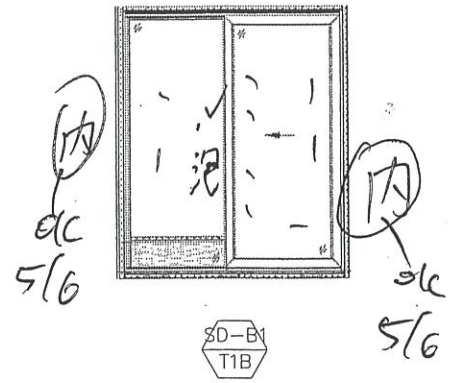
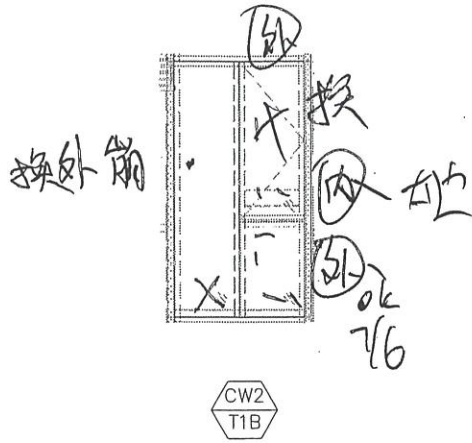

| 表<br>聯<br>檢<br>代<br>表 | 公司   | 姓名  | 簽名 | 日期        |
|-----------------------|------|-----|----|-----------|
|                       | MIDI | 盧國深 | ☞  | 30-5-2025 |
|                       | OSR  |     |    |           |

PROJECT: 康城11期凱柏峰

項目: 鋁窗, 鋁門及幕牆玻璃的驗收表格

TOWER: 1A

樓層: 18

單位: A

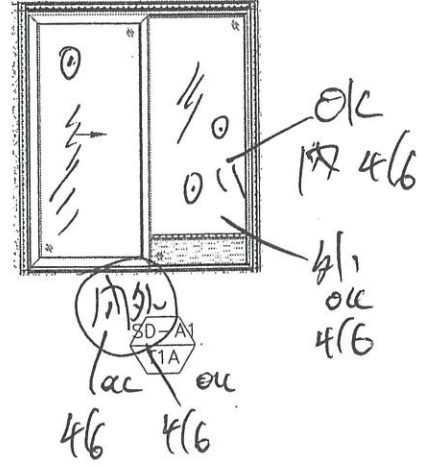
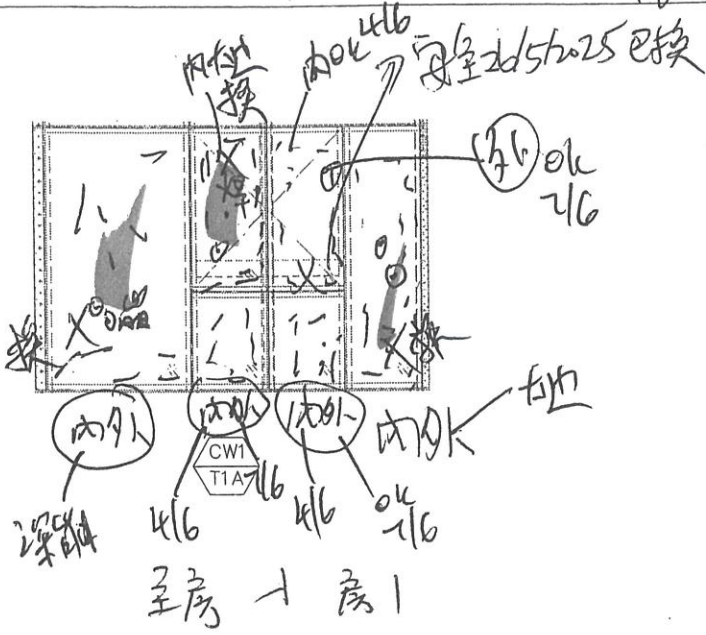

| 聯檢代表 | 公司   | 姓名  | 簽名 | 日期        |
|------|------|-----|----|-----------|
|      | MIDI | 盧國深 | ✓  | 2025-5-23 |
|      | OSR  |     |    |           |

PROJECT: 康城11期凱柏峰

項目: 鋁窗, 鋁門及幕牆玻璃的驗收表格

TOWER: 1A

樓層: 19

單位: A

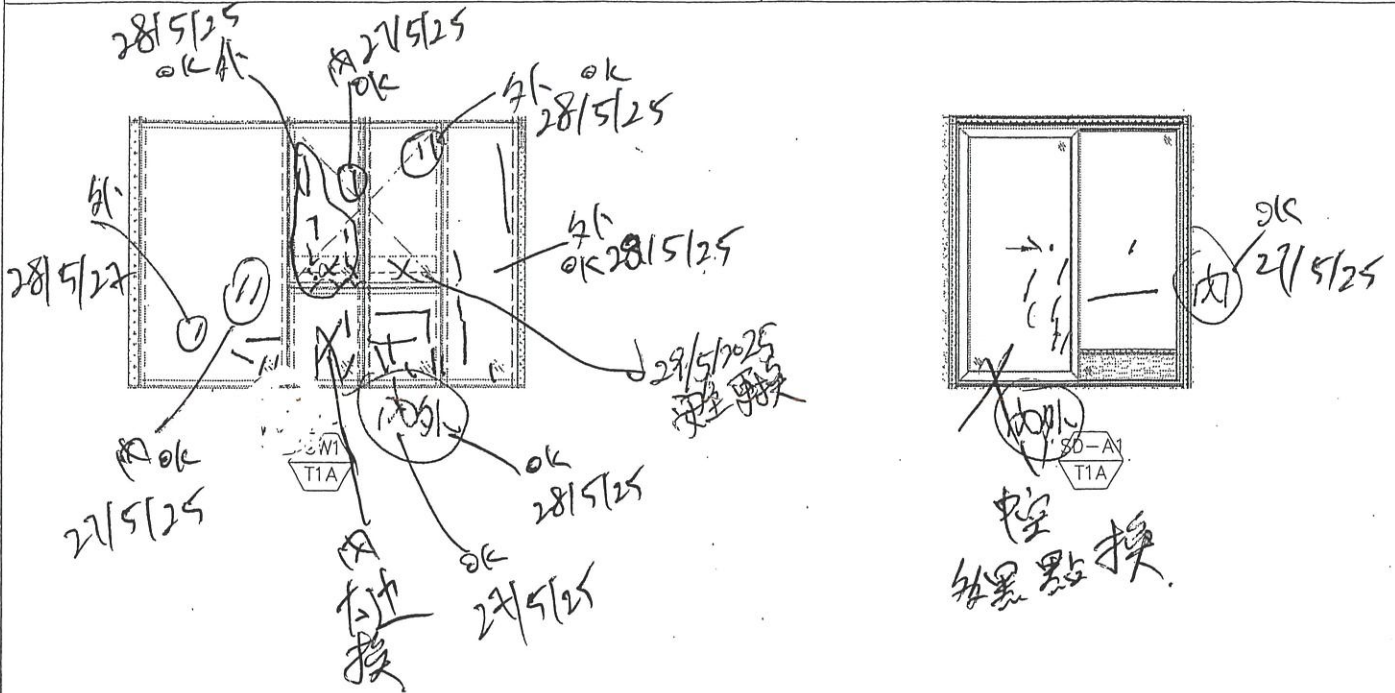

注: 外黑點換

| 聯檢代表 | 公司   | 姓名  | 簽名 | 日期        |
|------|------|-----|----|-----------|
|      | MIDI | 盧國深 | ✓  | 2025-5-24 |
|      | OSR  |     |    |           |

PROJECT: 康城11期凱柏峰

項目: 鋁窗, 鋁門及幕牆玻璃的驗收表格

TOWER: 1A

樓層: 20

單位: A

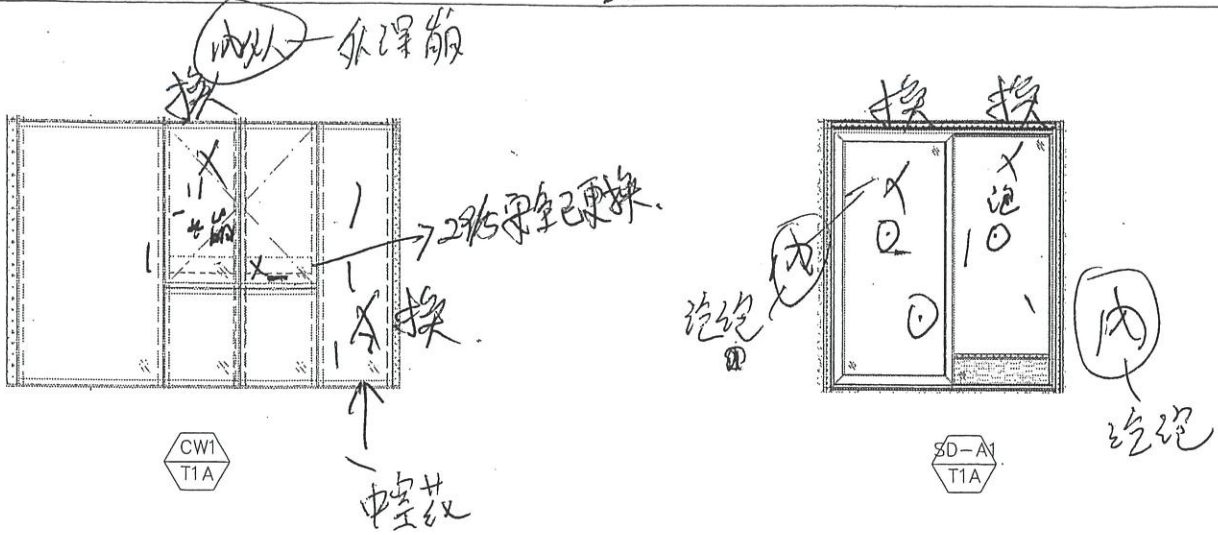

| 聯檢代表 | 公司   | 姓名  | 簽名 | 日期        |
|------|------|-----|----|-----------|
|      | MIDI | 盧國深 | ✓  | 2025-5-23 |
|      | OSR  |     |    |           |

PROJECT: 康城11期凱柏峰

項目: 鋁窗, 鋁門及幕牆玻璃的驗收表格

TOWER: 1B

樓層: 20

單位: D

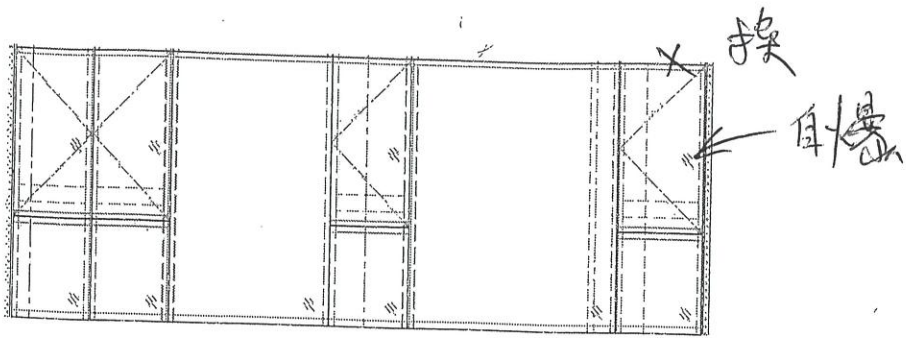

CW4  
T1B

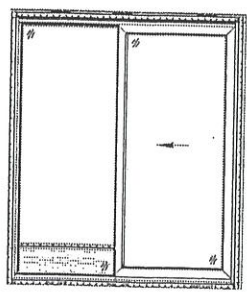

SD-D1  
T1B

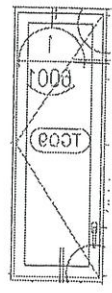

B1  
T1B-D

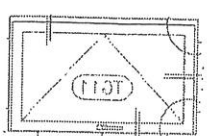

K1  
T1B-D

注: 主律料

|      |      |     |    |           |
|------|------|-----|----|-----------|
| 聯檢代表 | 公司   | 姓名  | 簽名 | 日期        |
|      | MIDI | 盧國深 | ✓  | 14-6-2025 |
|      | OSR  |     |    |           |

PROJECT: 康城11期凱柏峰

項目: 鋁窗, 鋁門及幕牆玻璃的驗收表格

TOWER: 1A 樓層: 20

單位: F

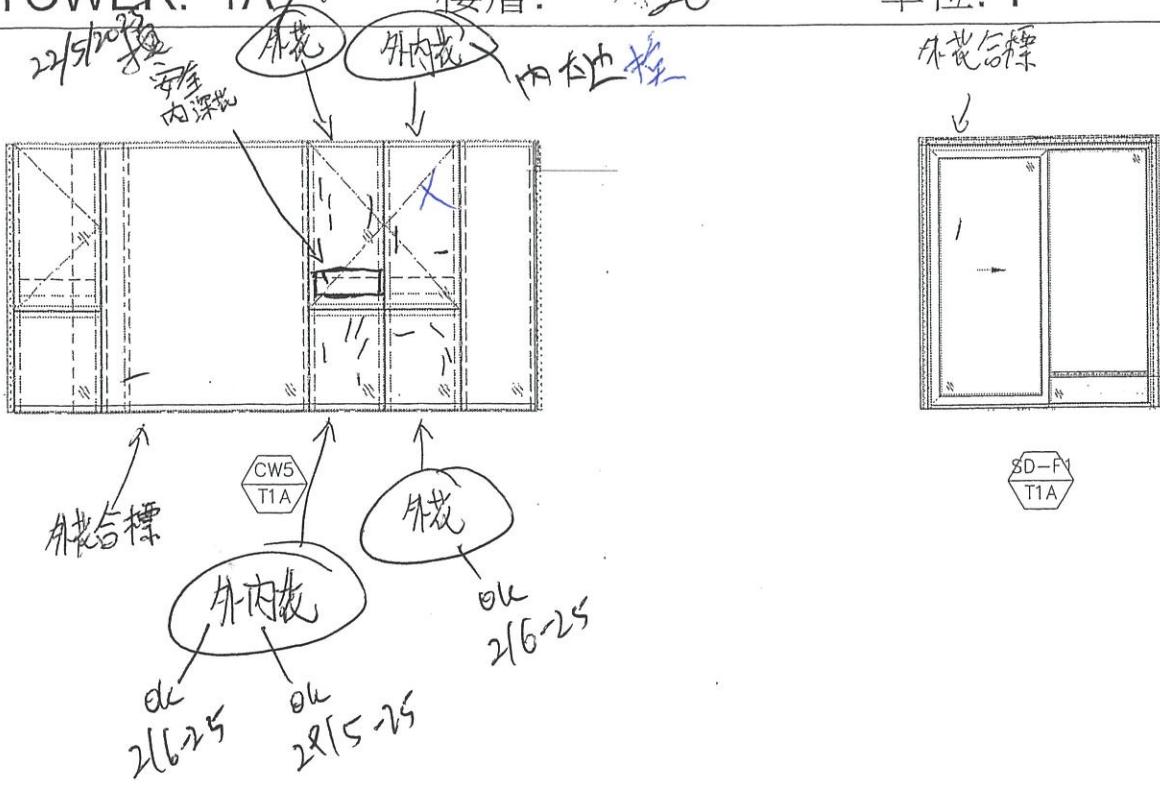

| 聯檢代表 | 公司   | 姓名  | 簽名 | 日期        |
|------|------|-----|----|-----------|
|      | MIDI | 盧國深 | ✓  | 17-5-2025 |
|      | OSR  |     |    |           |

PROJECT: 康城11期凱柏峰

項目: 鋁窗, 鋁門及幕牆玻璃的驗收表格

TOWER: 1B

樓層: 20

單位: B

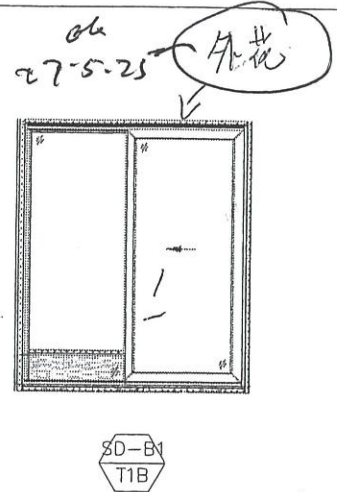
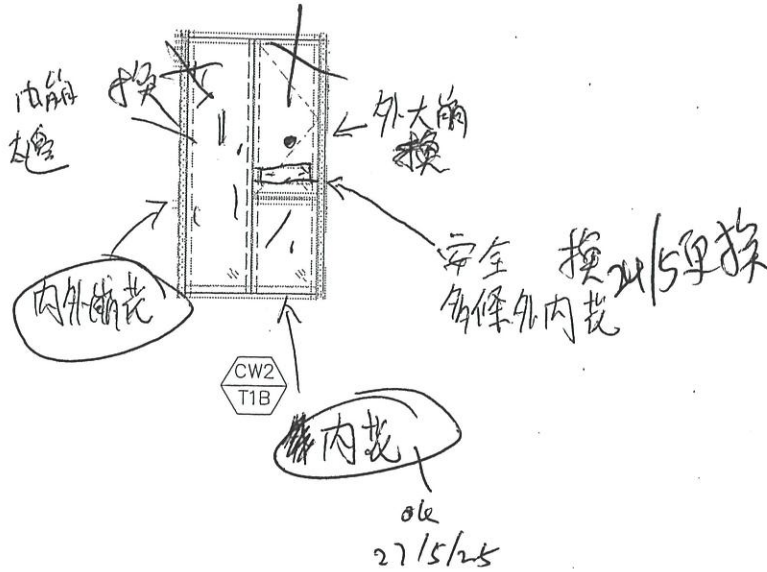

| 聯檢代表 | 公司   | 姓名  | 簽名 | 日期        |
|------|------|-----|----|-----------|
|      | MIDI | 盧國深 | ☞  | 17-5-2025 |
|      | OSR  |     |    |           |



美特鋁質有限公司  
MIDI ALUMINIUM FABRICATOR LTD.

PROJECT: 康城11期凱柏峰

項目: 鋁窗, 鋁門及幕牆玻璃的驗收表格

TOWER: 1B

樓層: 20

單位: C

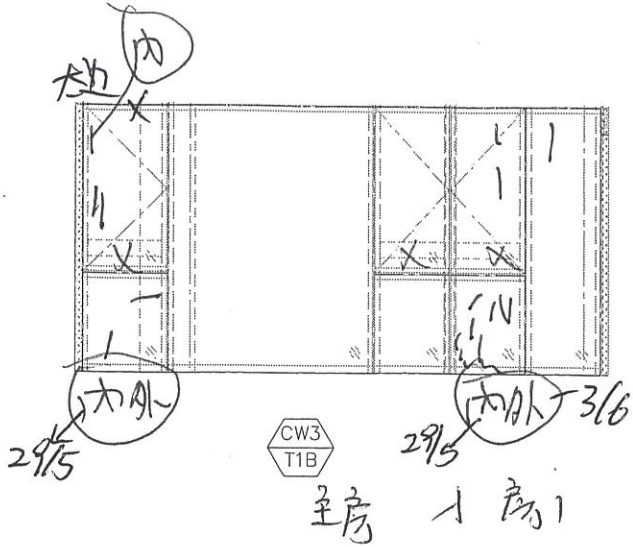

6/6更換  
3件安全紙

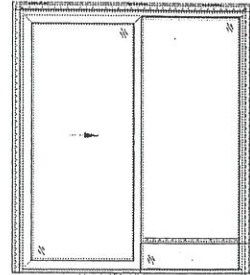

SD-C1  
T1B



B1  
T1B-C

注: 至待米斗

| 聯檢代表 | 公司   | 姓名  | 簽名 | 日期        |
|------|------|-----|----|-----------|
|      | MIDI | 盧國深 | ☞  | 2025-5-23 |
|      | OSR  |     |    |           |



美特鋁質有限公司  
MIDI ALUMINIUM FABRICATOR LTD.

PROJECT: 康城11期凱柏峰

項目: 鋁窗, 鋁門及幕牆玻璃的驗收表格

TOWER: 1B

樓層: 22

單位: B

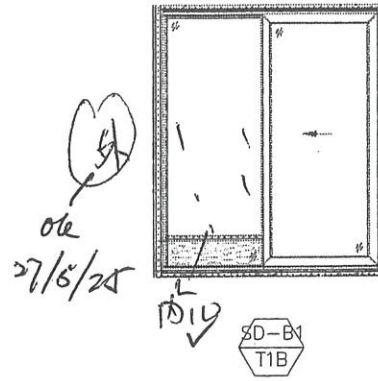
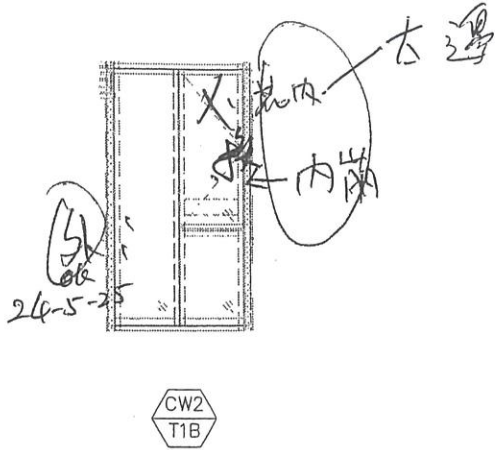

| 聯檢代表 | 公司   | 姓名  | 簽名 | 日期        |
|------|------|-----|----|-----------|
|      | MIDI | 盧國深 | ☞  | 16-5-2025 |
|      | OSR  |     |    |           |



美特鋁質有限公司  
MIDI ALUMINIUM FABRICATOR LTD.

PROJECT: 康城11期凱柏峰

項目: 鋁窗, 鋁門及幕牆玻璃的驗收表格

TOWER: 1A

樓層: 27

單位: E

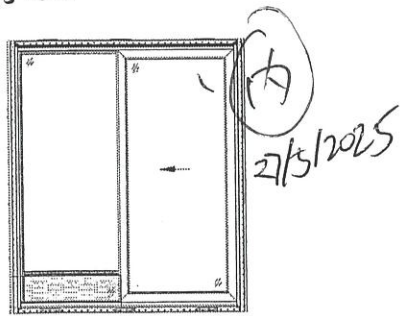
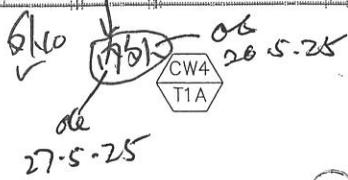
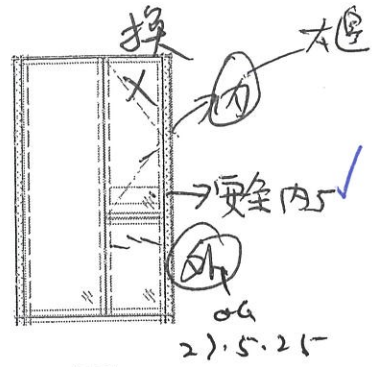
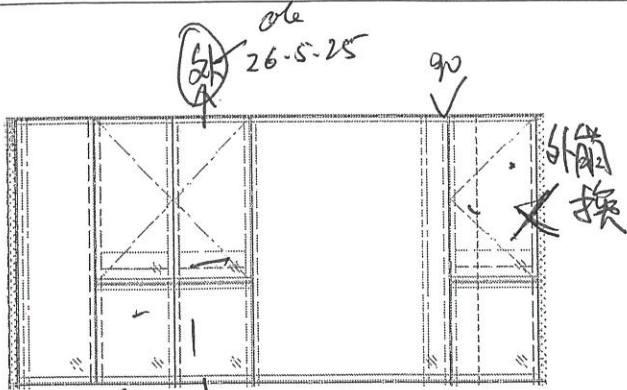

| 聯檢代表 | 公司   | 姓名  | 簽名    | 日期        |
|------|------|-----|-------|-----------|
|      | MIDI | 盧國深 | ..... | 17-5-2025 |
|      | OSR  |     |       |           |

PROJECT: 康城11期凱柏峰

項目: 鋁窗, 鋁門及幕牆玻璃的驗收表格

TOWER: 1B

樓層:

27-02 單位: C

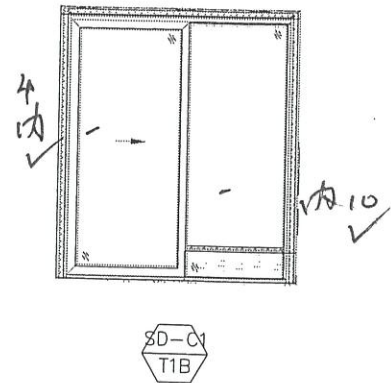
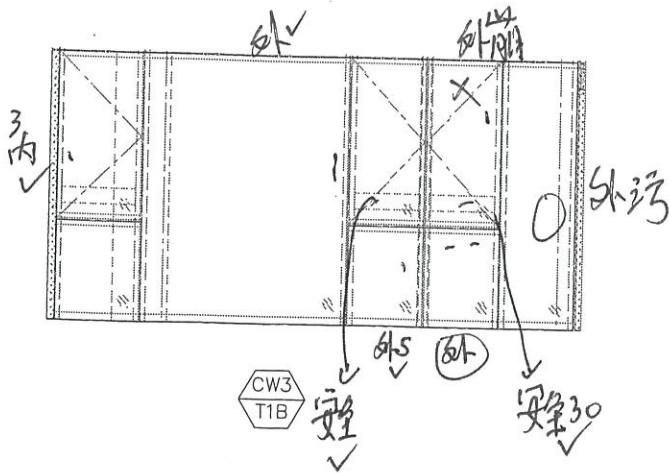

注: 房, 待料

| 聯檢代表 | 公司   | 姓名  | 簽名 | 日期 |
|------|------|-----|----|----|
|      | MIDI | 盧國深 | ⚡  |    |
|      | OSR  |     |    |    |





美特鋁質有限公司  
MIDI ALUMINIUM FABRICATOR LTD.

PROJECT: 康城11期凱柏峰

項目: 鋁窗, 鋁門及幕牆玻璃的驗收表格

TOWER: 1B 樓層: 30 02. 單位: B

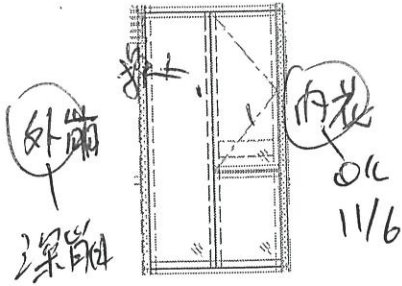

CW2  
T1B

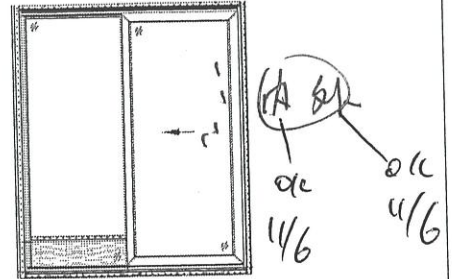

SD-B1  
T1B

注: 房待料1

| 聯檢代表 | 公司   | 姓名  | 簽名 | 日期 |
|------|------|-----|----|----|
|      | MIDI | 盧國深 | ⚡  |    |
|      | OSR  |     |    |    |



PROJECT: 康城11期凱柏峰

項目: 鋁窗, 鋁門及幕牆玻璃的驗收表格 <sup>02</sup>

TOWER: 1A

樓層: 52

單位: E

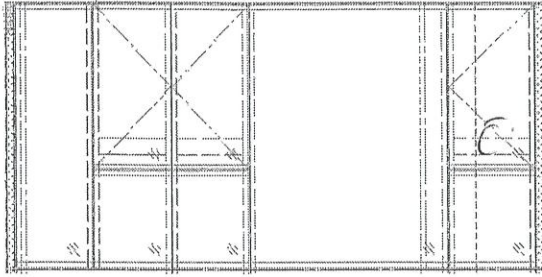

CW4  
T1A



CW4  
T1A

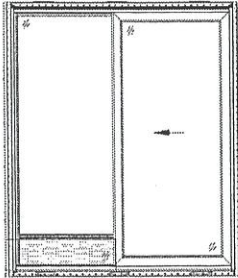

SD-E1  
T1A

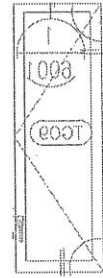

B1  
T1A-E

注: 主材料

| 聯檢代表 | 公司   | 姓名  | 簽名    | 日期        |
|------|------|-----|-------|-----------|
|      | MIDI | 盧國深 | ..... | 12-6-2025 |
|      | OSR  |     |       |           |

PROJECT: 康城11期凱柏峰

右匙

項目: 鋁窗, 鋁門及幕牆玻璃的驗收表格

TOWER: 1B

樓層: 33

單位: A

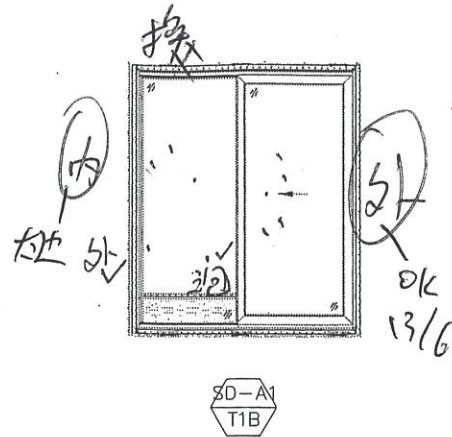
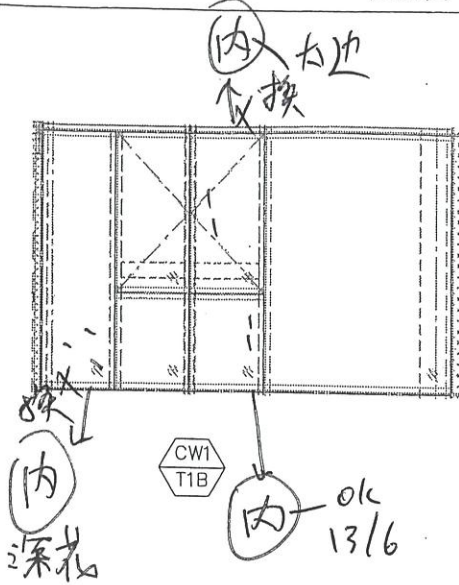

房 1 至房

| 聯檢代表 | 公司   | 姓名  | 簽名 | 日期        |
|------|------|-----|----|-----------|
|      | MIDI | 盧國深 | ✓  | 30-5-2025 |
|      | OSR  |     |    |           |



PROJECT: 康城11期凱柏峰

項目: 鋁窗, 鋁門及幕牆玻璃的驗收表格

TOWER: 1B

樓層: 33

單位: F

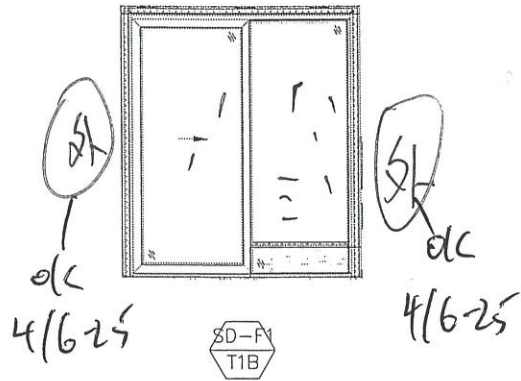

| 聯檢代表 | 公司   | 姓名  | 簽名 | 日期       |
|------|------|-----|----|----------|
|      | MIDI | 盧國深 | ✓  | 2/6/2025 |
|      | OSR  |     |    |          |



PROJECT: 康城11期凱柏峰

項目: 鋁窗, 鋁門及幕牆玻璃的驗收表格

TOWER: 1B

樓層: 37

單位: C

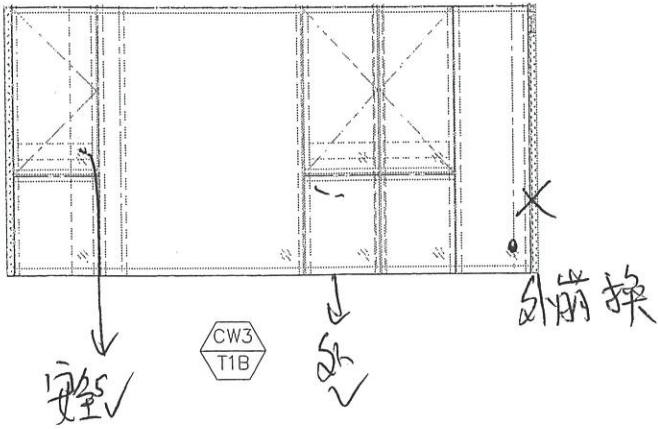

CW3  
T1B

SD-C1  
T1B

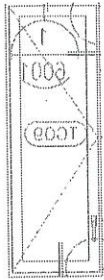

B1  
T1B-C

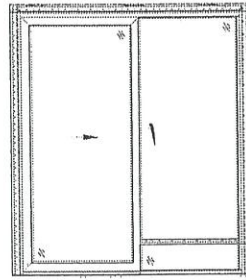

| 聯檢代表 | 公司   | 姓名  | 簽名 | 日期        |
|------|------|-----|----|-----------|
|      | MIDI | 盧國深 | ☞  | 2025-2025 |
|      | OSR  |     |    |           |



美特鋁質有限公司  
MIDI ALUMINIUM FABRICATOR LTD.

PROJECT: 康城11期凱柏峰

項目: 鋁窗, 鋁門及幕牆玻璃的驗收表格

TOWER: 1B

樓層:

39

單位: D

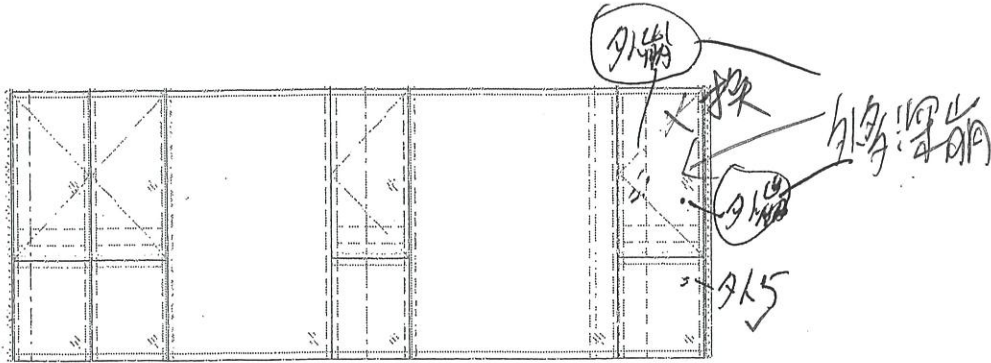

CW4  
T1B

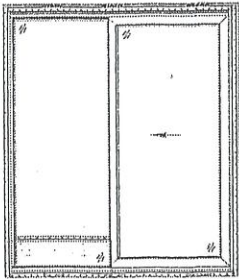

SD-D1  
T1B

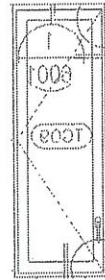

B1  
T1B-D



K1  
T1B-D

| 聯檢代表 | 公司   | 姓名  | 簽名 | 日期        |
|------|------|-----|----|-----------|
|      | MIDI | 盧國深 | ✓  | 22-5-2025 |
|      | OSR  |     |    |           |

PROJECT: 康城11期凱柏峰

項目: 鋁窗, 鋁門及幕牆玻璃的驗收表格

TOWER: 1A

樓層: 39

單位: E

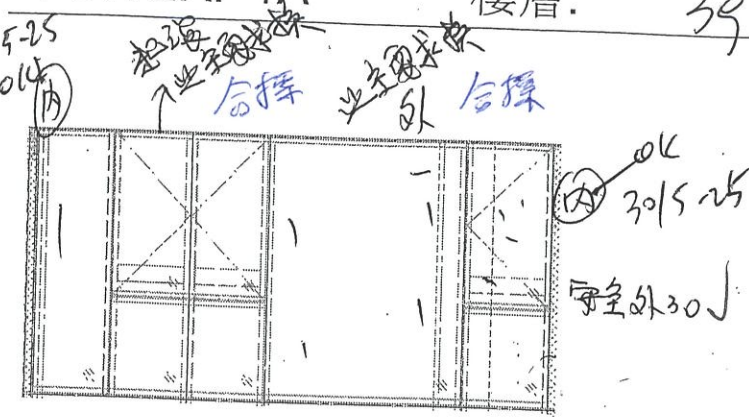

CW4  
T1A

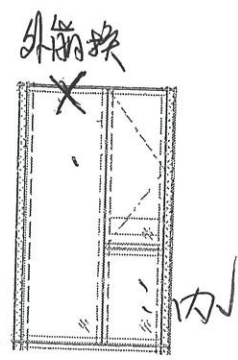

CW4  
T1A

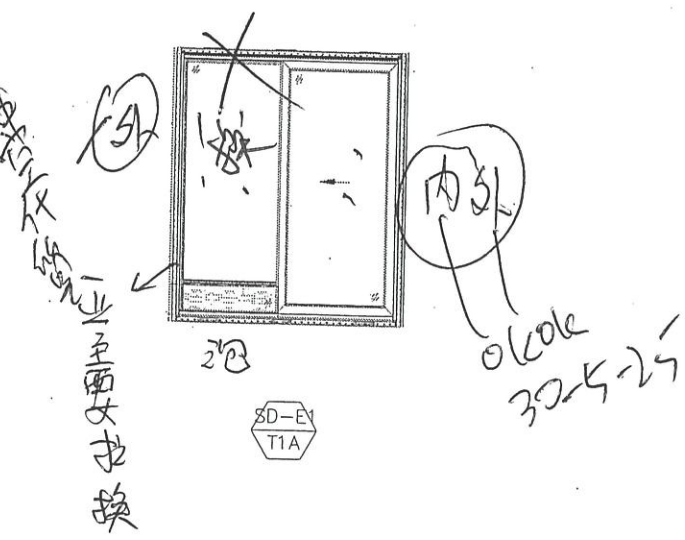

SD-EV  
T1A

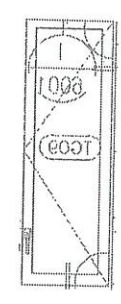

B1  
T1A-E

| 公司   | 姓名  | 簽名 | 日期        |
|------|-----|----|-----------|
| MIDI | 盧國深 | ✓  | 29-5-2025 |
| OSR  |     |    |           |

PROJECT: 康城11期凱柏峰

項目: 鋁窗, 鋁門及幕牆玻璃的驗收表格

TOWER: 1A 樓層: 39-02 單位: E

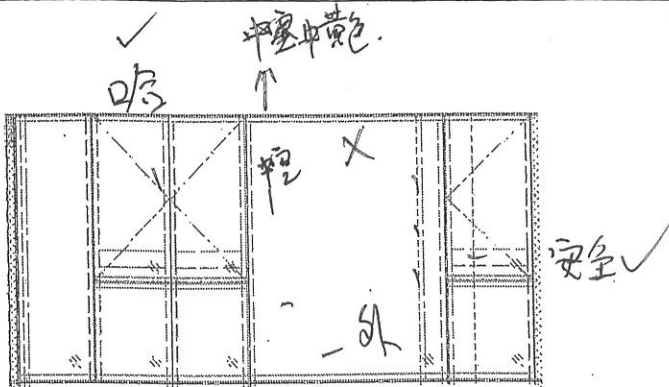

CW4  
T1A

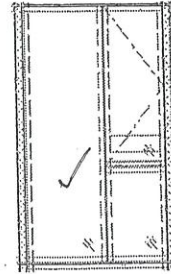

CW4  
T1A

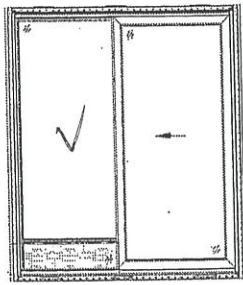

SD-EY  
T1A



B1  
T1A-E

注: 主材料

| 表  | 公司   | 姓名  | 簽名  | 日期 |
|----|------|-----|-----|----|
| 檢代 | MIDI | 盧國深 | ... |    |



美特鋁質有限公司  
MIDI ALUMINIUM FABRICATOR LTD.

PROJECT: 康城11期凱柏峰

項目: 鋁窗, 鋁門及幕牆玻璃的驗收表格

TOWER: 1A

樓層: 41

工作單位: A

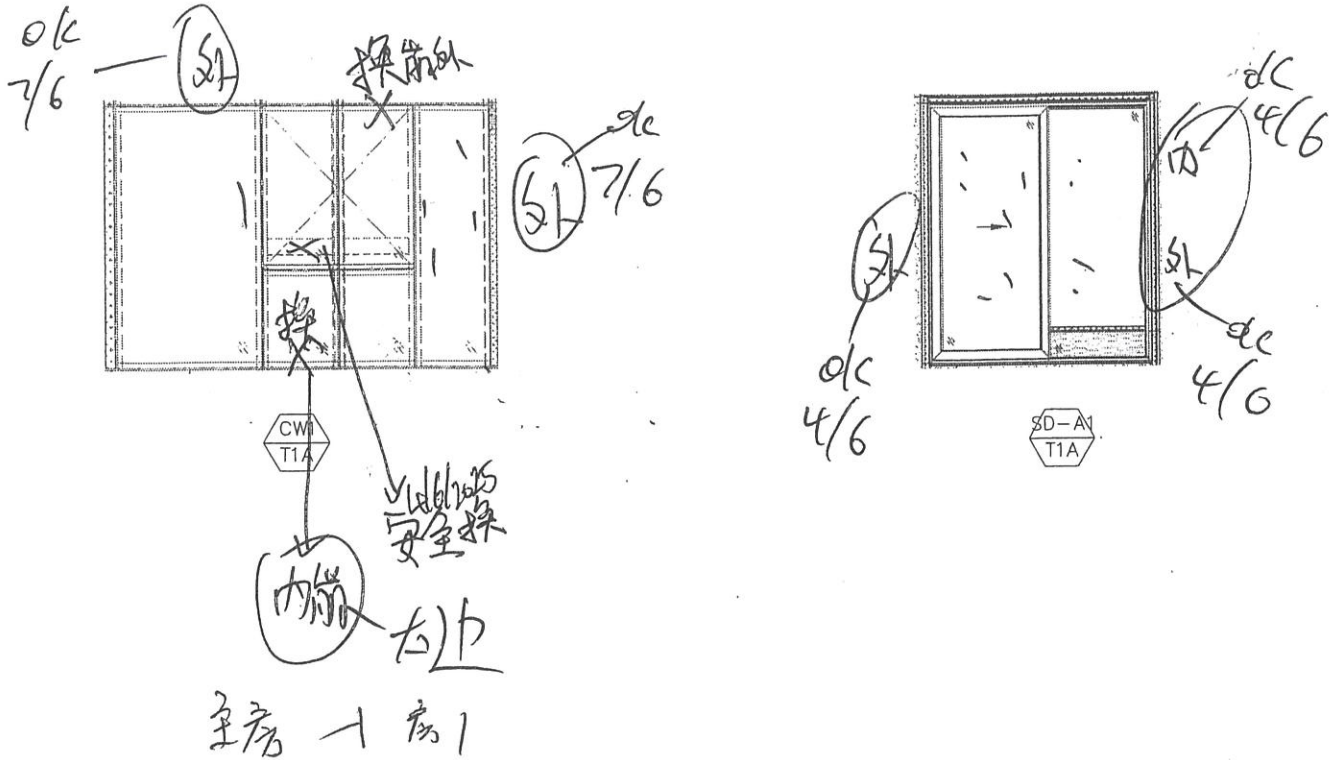

| 聯檢代表 | 公司   | 姓名  | 簽名 | 日期        |
|------|------|-----|----|-----------|
|      | MIDI | 盧國深 | ✓  | 30-5-2025 |
|      | OSR  |     |    |           |

PROJECT: 康城11期凱柏峰

項目: 鋁窗, 鋁門及幕牆玻璃的驗收表格

TOWER: 1B

樓層: 42

單位: C

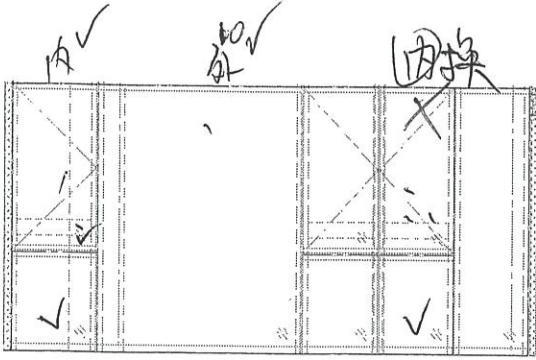

CW3  
T1B

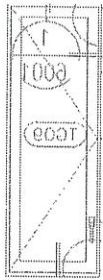

B1  
T1B-C

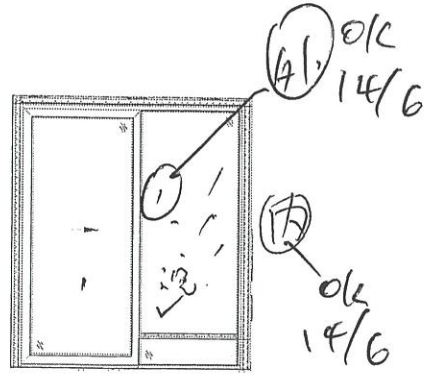

✓ 10

外

SD-C1  
T1B

注: 房待料

| 聯檢代表 | 公司   | 姓名  | 簽名 | 日期 |
|------|------|-----|----|----|
|      | MIDI | 盧國深 | ⚡  |    |
|      | OSR  |     |    |    |

PROJECT: 康城11期凱柏峰

項目: 鋁窗, 鋁門及幕牆玻璃的驗收表格

TOWER: 1A

樓層: 45

單位: C

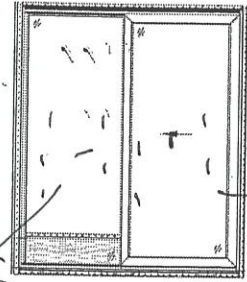
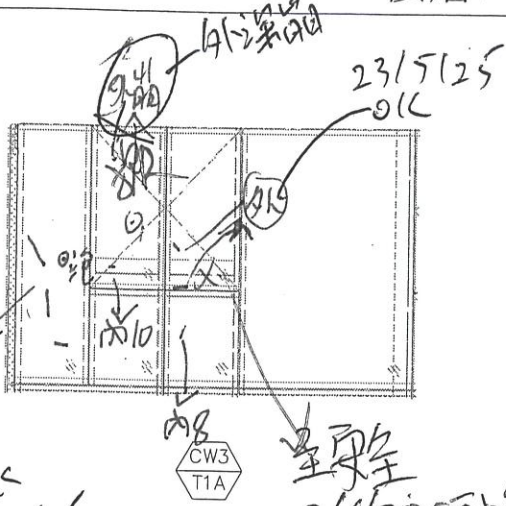

內8  
OK  
28/5/25

內15  
OK  
28/5/25

內15  
OK  
28/5/25

| 聯名 | 公司   | 姓名  | 簽名 | 日期        |
|----|------|-----|----|-----------|
|    | MIDI | 盧國深 | ✓  | 2025-5-21 |
|    | OSR  |     |    |           |

PROJECT: 康城11期凱柏峰

項目: 鋁窗, 鋁門及幕牆玻璃的驗收表格

TOWER: 1A

樓層:

45

單位: F

外窗換

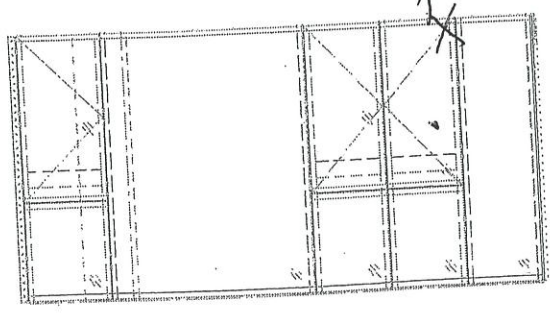

CWS  
T1A

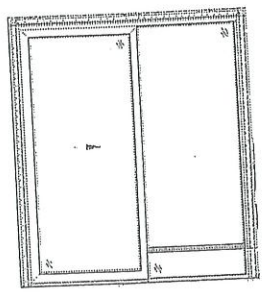

SD-F  
T1A

| 表<br>聯<br>檢<br>代<br>表 | 公司   | 姓名  | 簽名 | 日期        |
|-----------------------|------|-----|----|-----------|
|                       | MIDI | 盧國深 | ✓  | 28-5-2025 |
|                       | OSR  |     |    |           |

PROJECT: 康城11期凱柏峰

項目: 鋁窗, 鋁門及幕牆玻璃的驗收表格

TOWER: 1A

樓層: 47

單位: F

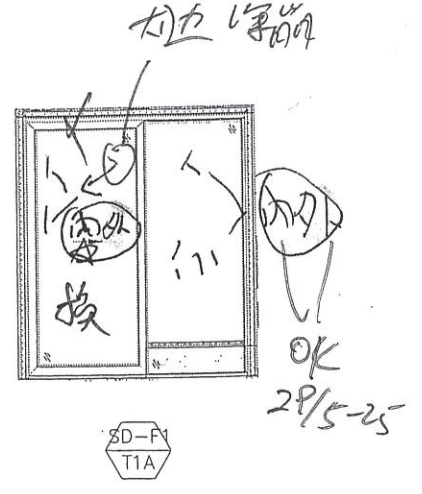
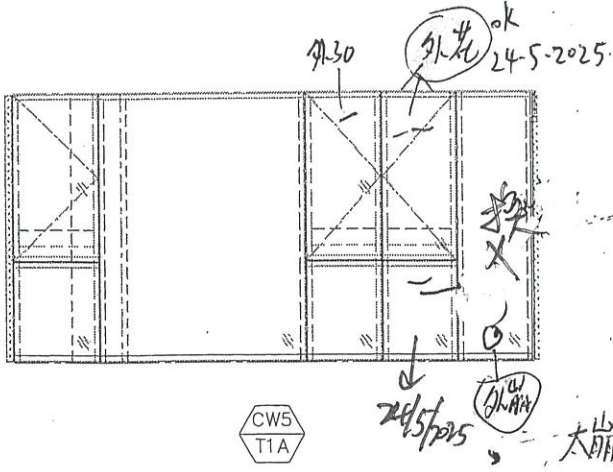

| 聯檢代表 | 公司   | 姓名  | 簽名 | 日期        |
|------|------|-----|----|-----------|
|      | MIDI | 盧國深 | ✓  | 2025-5-21 |
|      | OSR  |     |    |           |

PROJECT: 康城11期凱柏峰

頁目: 鋁窗, 鋁門及幕牆玻璃的驗收表格

OWER: 1A

樓層:

48

單位: A

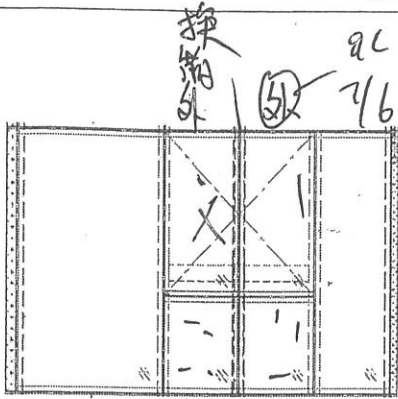

01L  
76  
主房  
內外  
76  
2L  
76

| 公司   | 姓名  | 簽名 | 日期       |
|------|-----|----|----------|
| MIDI | 盧國琛 | ✓  | 5-6-2025 |
| OSR  |     |    |          |

PROJECT: 康城11期凱柏峰

項目: 鋁窗, 鋁門及幕牆玻璃的驗收表格

TOWER: 1B

樓層: 48

02-03

單位: D

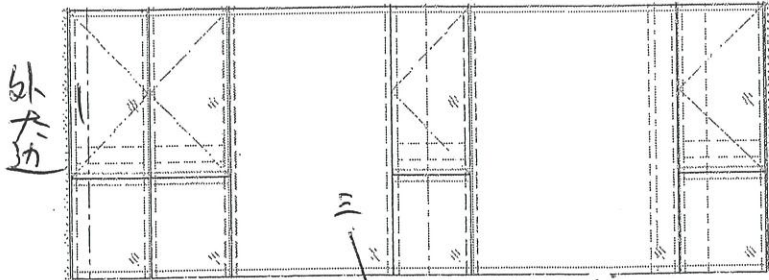

CW4  
T1B

外大边

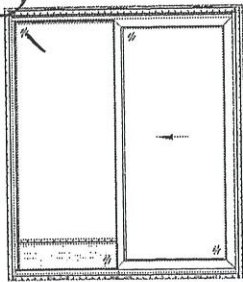

SD-D1  
T1B

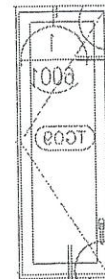

B1  
T1B-D



K1  
T1B-D

注: 房2生窗待料1  
厅待料1 > 2

| 聯檢代表 | 公司   | 姓名  | 簽名 | 日期        |
|------|------|-----|----|-----------|
|      | MIDI | 盧國深 | ✓  | 14-6-2025 |
|      | OSR  |     |    |           |

PROJECT: 康城11期凱柏峰

項目: 鋁窗, 鋁門及幕牆玻璃的驗收表格

TOWER: 1A

樓層: 49

單位: F

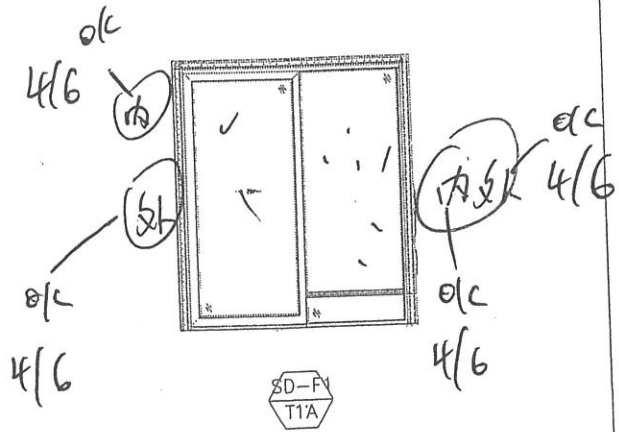
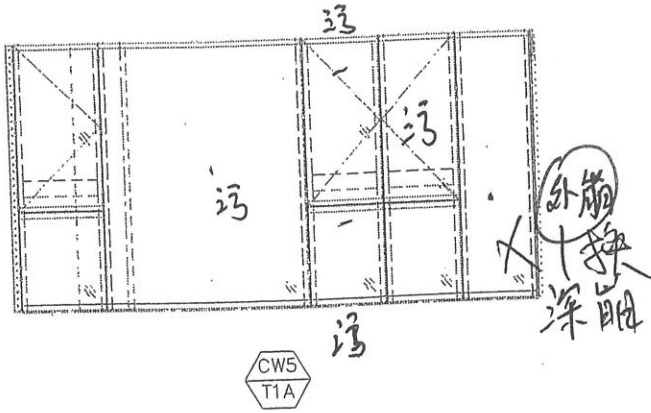

| 聯檢代表 | 公司   | 姓名  | 簽名 | 日期       |
|------|------|-----|----|----------|
|      | MIDI | 盧國深 | ✓  | 2/6/2025 |
|      | OSR  |     |    |          |



PROJECT: 康城11期凱柏峰

項目: 鋁窗, 鋁門及幕牆玻璃的驗收表格

TOWER: 1A

樓層: 55

單位: C

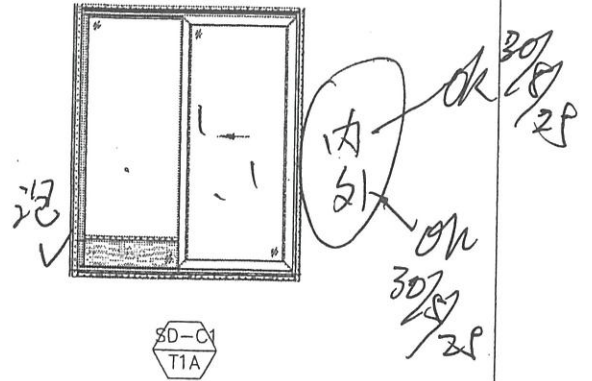
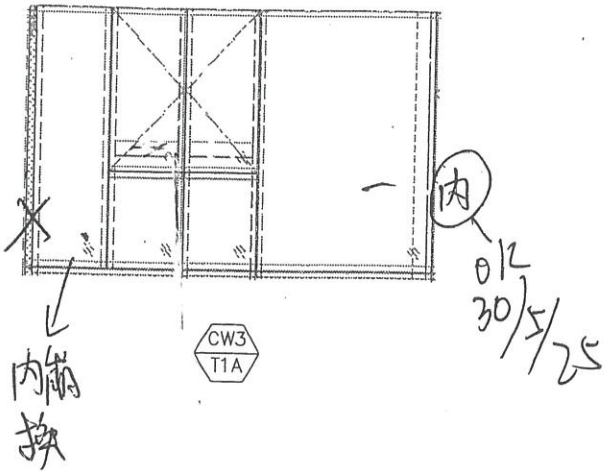

|      |      |     |    |           |
|------|------|-----|----|-----------|
| 聯檢代表 | 公司   | 姓名  | 簽名 | 日期        |
|      | MIDI | 盧國深 | ✓  | 28-5-2025 |
|      | OSR  |     |    |           |



CT: 康城11期凱柏峰

項目: 鋁窗, 鋁門及幕牆玻璃的驗收表格

樓層: 59

單位: C

單位: C

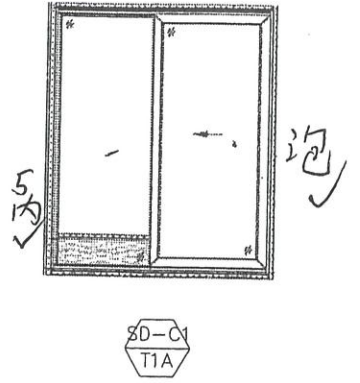
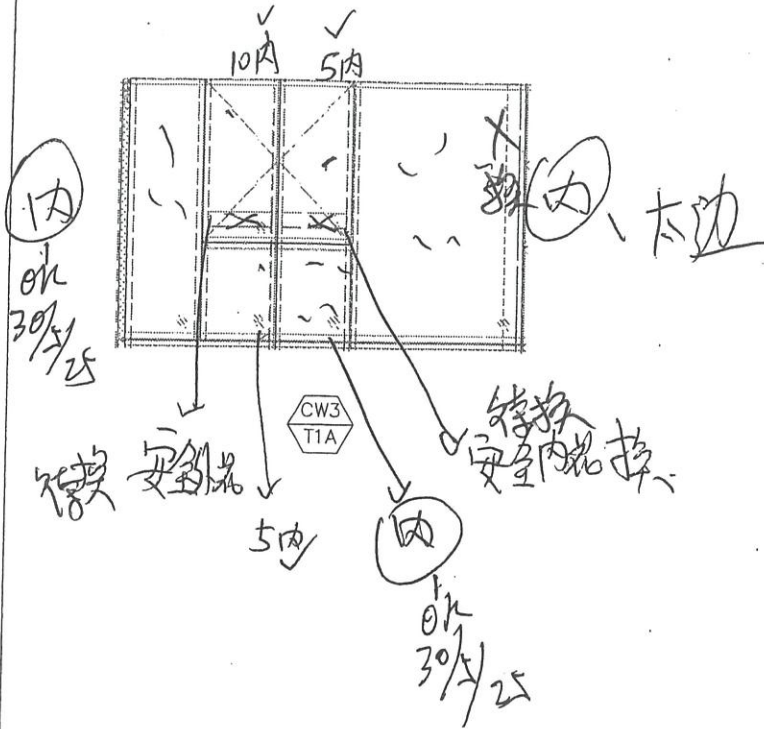

| 聯檢代表 | 公司   | 姓名  | 簽名 | 日期        |
|------|------|-----|----|-----------|
|      | MIDI | 盧國深 | ✓  | 28-5-2025 |
|      | OSR  |     |    |           |

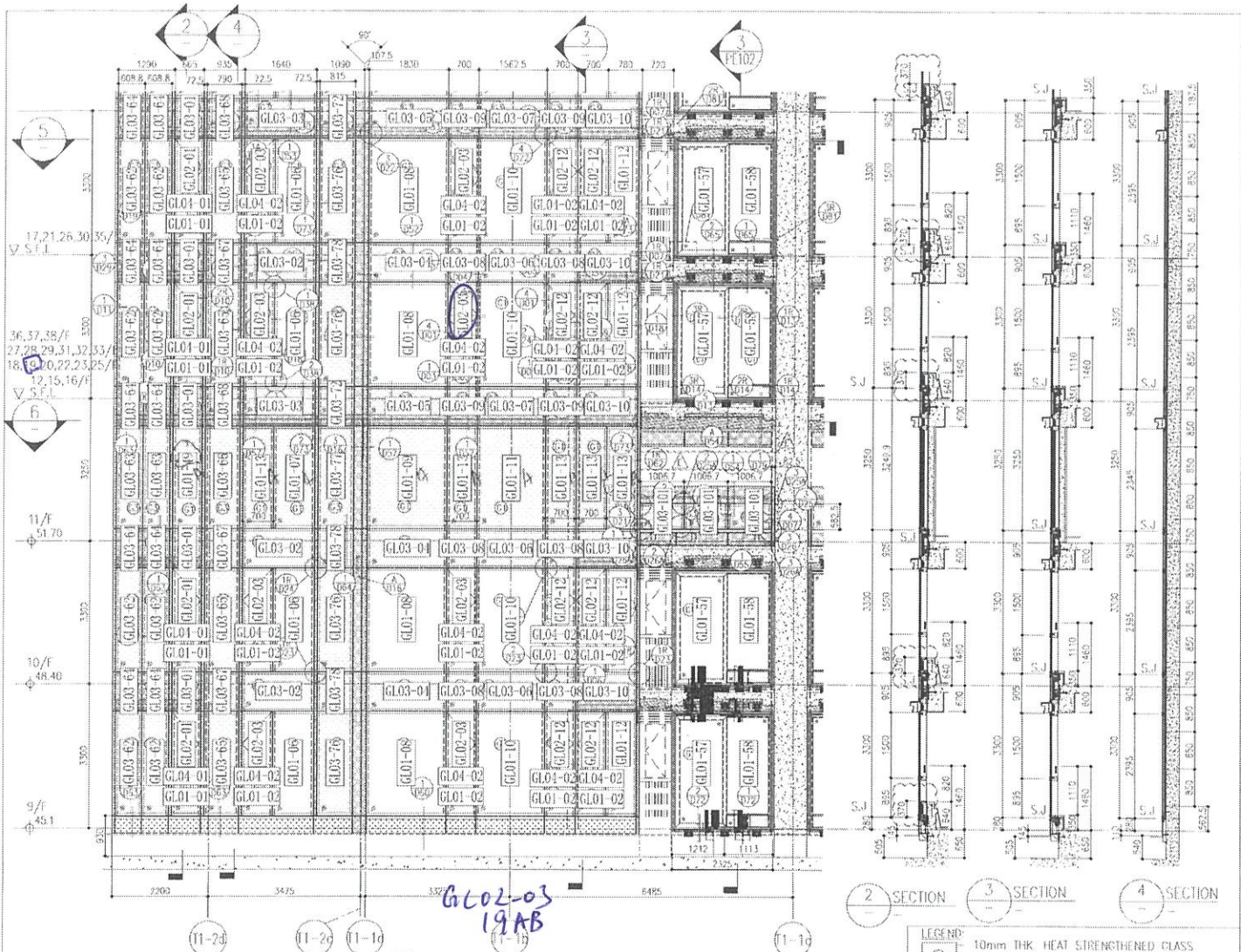

1 PART ELEVATION FOR CURTAIN WALL

ARCH FEATURE AT 11/F, 17/F, 21/F, 26/F, 30/F, 35/F,  
 ARCH FEATURE AT 9/F, 10/F, 12/F, 15/F-16/F, 18/F, 20/F, 22/F, 25/F, 27/F-29/F, 31/F-33/F, 36/F-38/F.

|      |        |      |         |      |         |
|------|--------|------|---------|------|---------|
| 26/F | +91.25 | 39/F | +130.85 | 52/F | +170.40 |
| 25/F | +87.95 | 38/F | +127.55 | 51/F | +167.10 |
| 23/F | +84.65 | 37/F | +124.25 | 50/F | +163.80 |
| 22/F | +81.35 | 36/F | +120.95 | 49/F | +160.50 |
| 21/F | +78.05 | 35/F | +117.65 | 48/F | +157.20 |
| 20/F | +74.75 | 33/F | +114.35 | 47/F | +153.90 |
| 19/F | +71.45 | 32/F | +111.05 | 46/F | +150.60 |
| 18/F | +68.15 | 31/F | +107.75 | 45/F | +147.30 |
| 17/F | +64.85 | 30/F | +104.45 | 43/F | +144.00 |
| 16/F | +61.55 | 29/F | +101.15 | 42/F | +140.70 |
| 15/F | +58.25 | 28/F | +97.85  | 41/F | +137.40 |
| 12/F | +54.95 | 27/F | +94.55  | 40/F | +134.15 |
|      |        |      |         | 53/F | +173.70 |

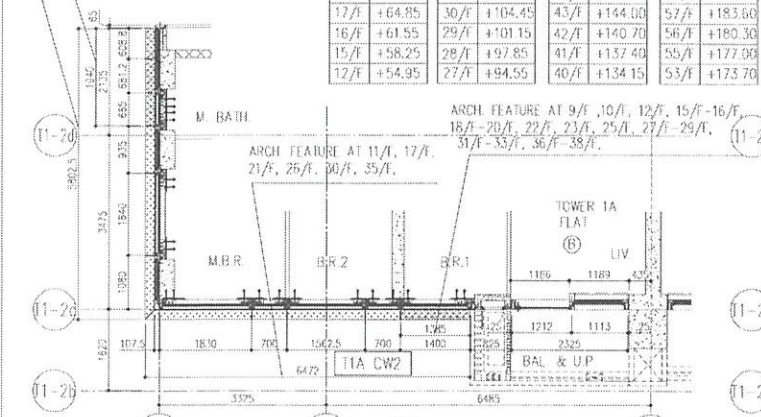

5 PART PLAN FOR CURTAIN WALL

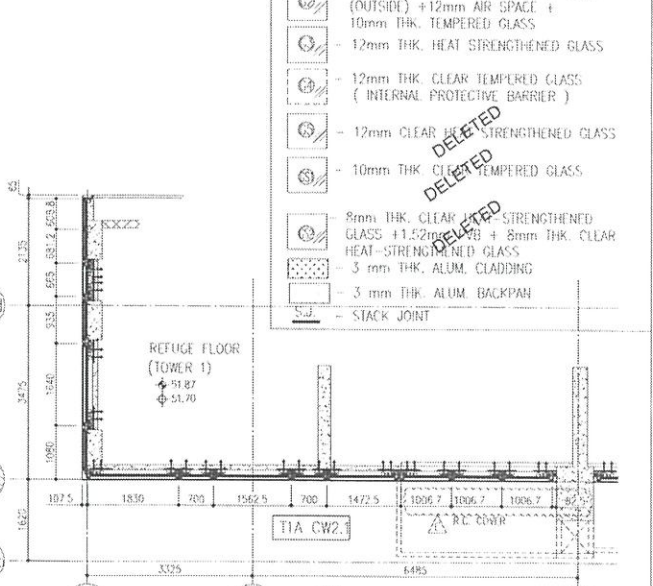

6 PART PLAN (11/F) FOR CURTAIN WALL

- LEGEND
- 10mm THK HEAT STRENGTHENED GLASS (OUTSIDE) +12mm AIR SPACE + 12mm THK TEMPERED GLASS
  - 10mm THK HEAT STRENGTHENED GLASS (OUTSIDE) +12mm AIR SPACE + 10mm THK TEMPERED GLASS
  - 12mm THK HEAT STRENGTHENED GLASS
  - 12mm THK CLEAR TEMPERED GLASS (INTERNAL PROTECTIVE BARRIER)
  - 12mm CLEAR HEAT STRENGTHENED GLASS
  - 10mm THK CLEAR TEMPERED GLASS
  - 8mm THK CLEAR HEAT STRENGTHENED GLASS +1.52mm AIR SPACE + 8mm THK CLEAR HEAT STRENGTHENED GLASS
  - 3mm THK ALUM. CLADDING
  - 3mm THK ALUM. BACKPAN
  - STACK JOINT

|  |   |   |   |  |          |
|--|---|---|---|--|----------|
| <br>MID-ASIA DEVELOPMENT PIONEER LTD<br>810 Cheong Cheong Street, Kowloon<br>Tel: (852) 27777655 Fax: (852) 27777655 | <br>Ronald Lu & Partners (HK) Ltd<br>15/F, 150 Des Voeux Road, West, Hong Kong<br>Tel: (852) 22222222 Fax: (852) 22222222 | <br>Sino Land Company Limited<br>15/F, 150 Des Voeux Road, West, Hong Kong<br>Tel: (852) 22222222 Fax: (852) 22222222 | <br>AECOM<br>15/F, 150 Des Voeux Road, West, Hong Kong<br>Tel: (852) 22222222 Fax: (852) 22222222 | <br>Gammon<br>15/F, 150 Des Voeux Road, West, Hong Kong<br>Tel: (852) 22222222 Fax: (852) 22222222 | <br>T1AB |
|  |   |   |   |  |          |

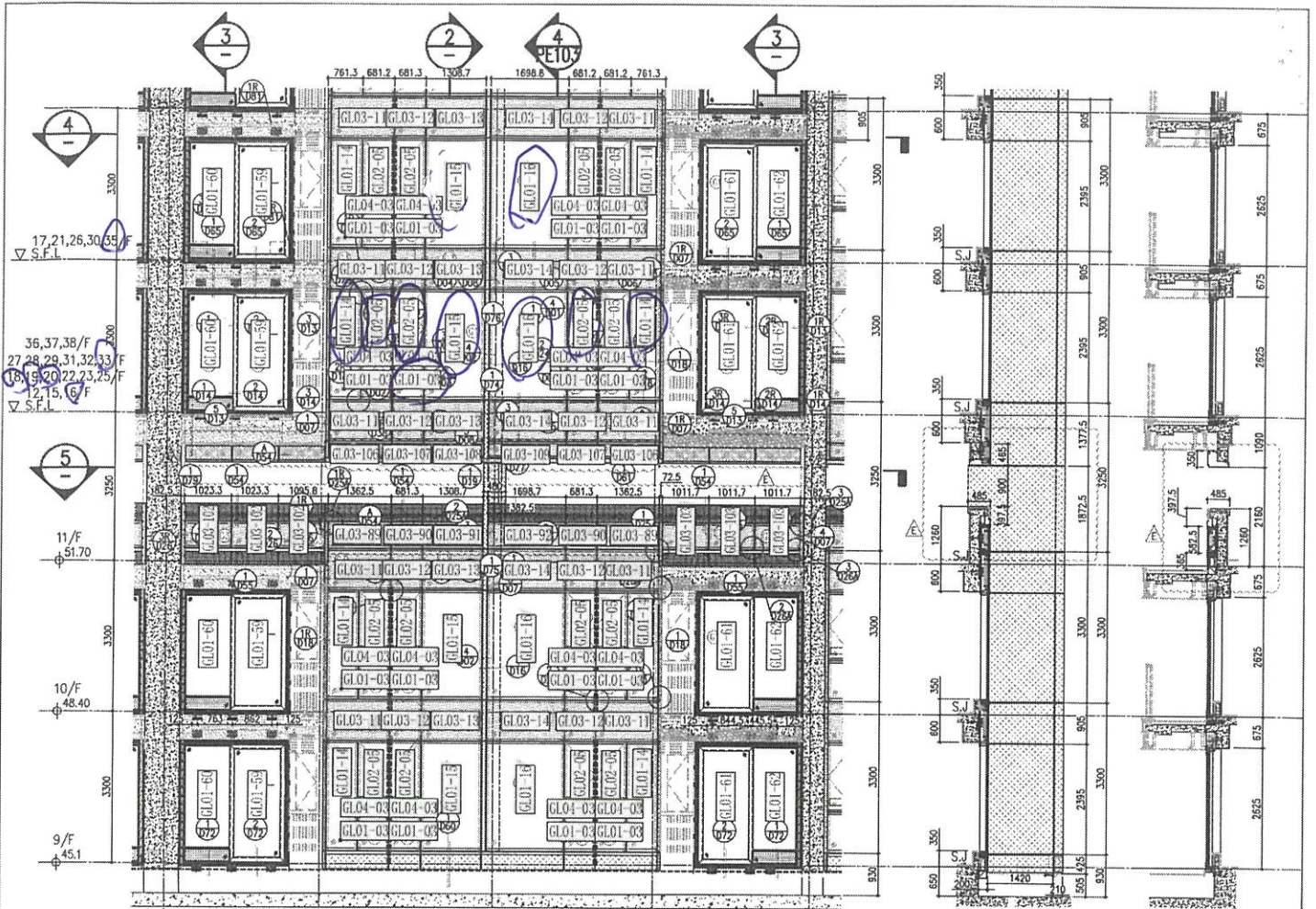

2 SECTION      3 SECTION

|             |              |              |              |
|-------------|--------------|--------------|--------------|
| 26/F +91.25 | 39/F +130.85 | 52/F +170.40 |              |
| 25/F +87.95 | 38/F +127.55 | 51/F +167.10 | R/F +203.80  |
| 23/F +84.65 | 37/F +124.25 | 50/F +163.80 | 62/F +200.30 |
| 22/F +81.35 | 36/F +120.95 | 49/F +160.50 | 61/F +196.80 |
| 21/F +78.05 | 35/F +117.65 | 48/F +157.20 | 60/F +193.50 |
| 20/F +74.75 | 33/F +114.35 | 47/F +153.90 | 59/F +190.20 |
| 19/F +71.45 | 32/F +111.05 | 46/F +150.60 | 58/F +186.90 |
| 18/F +68.15 | 31/F 107.75  | 45/F +147.30 | 57/F +183.60 |
| 17/F +64.85 | 30/F +104.45 | 43/F +144.00 | 56/F +180.30 |
| 16/F +61.55 | 29/F +101.15 | 42/F +140.70 | 55/F +177.00 |
| 15/F +58.25 | 28/F +97.85  | 41/F +137.40 | 54/F +173.70 |
| 12/F +54.95 | 27/F +94.55  | 40/F +134.15 |              |

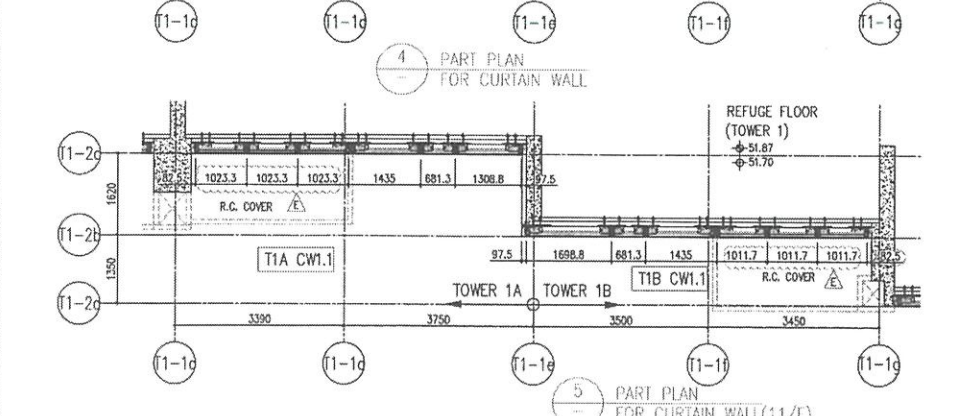
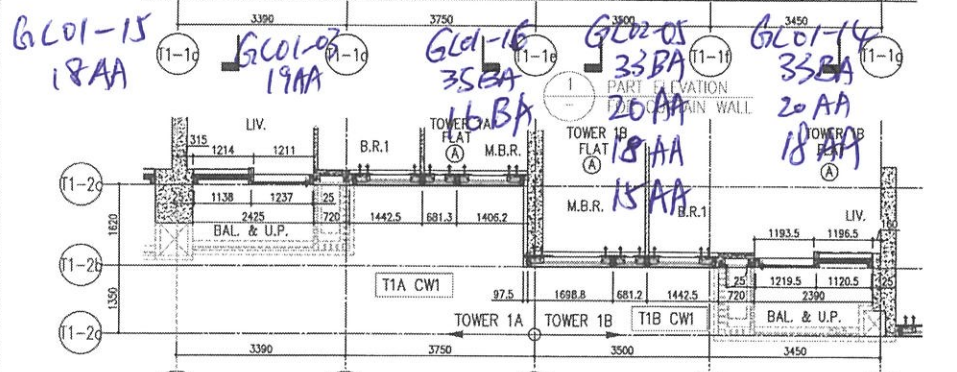

LEGEND:

- 10mm THK HEAT STRENGTHENED GLASS (OUTSIDE) +12mm AIR SPACE + 12mm THK. TEMPERED GLASS
- 10mm THK. HEAT STRENGTHENED GLASS (OUTSIDE) +12mm AIR SPACE + 10mm THK. TEMPERED GLASS
- 12mm THK HEAT STRENGTHENED GLASS
- 12mm THK. CLEAR TEMPERED GLASS ( INTERNAL PROTECTIVE BARRIER )
- 12mm CLEAR STRENGTHENED GLASS
- 10mm THK. CLEAR TEMPERED GLASS
- 8mm THK. CLEAR HEAT STRENGTHENED GLASS +1.52mm AIR SPACE + 8mm THK. CLEAR HEAT-STRENGTHENED GLASS
- 3 mm THK. ALUM. CLADDING
- 3 mm THK. ALUM. BACKPAN
- STACK JOINT

DELETED

|  |   |                          |  |  |  |                              |
|--|---|--------------------------|--|--|--|------------------------------|
| <p>PROJECT: PROPOSED RESIDENTIAL DEVELOPMENT AT TOWER 20/21, PHASE 11, LUNGS PARK, TSEUNG KWAN O, N.T.</p> <p>DATE: 22-07-21 SCALE: 1:150(A1)</p> <p>DRAWN BY: [Name]</p> <p>CHECKED BY: [Name]</p> <p>TITLE: TYPICAL FLOOR PARTIAL ELEVATION &amp; SECTION, PLAN FOR CURTAIN WALL (TOWER 1)</p> | <p>NO. REV. DESCRIPTION</p> <p>1. 23/07/21 REVISED AS PER COMMENTS</p> <p>2. 06/08/21 REVISED AS PER COMMENTS</p> <p>3. 24/08/21 REVISED AS PER COMMENTS</p> <p>4. 20/12/21 REVISED AS PER COMMENTS</p> <p>5. 02/12/21 REVISED AS PER COMMENTS</p> <p>6. 02/12/21 REVISED AS PER COMMENTS</p> | <p>DESIGN NO.: J-888</p> | <p>1. ALL DIMENSIONS ARE IN mm.</p> <p>2. ALL ELEMENTS ARE TO BE FINISHED FROM OUTSIDE BEFORE FABRICATION.</p> <p>3. 1. FEEL - FINISHED FLOOR LEVEL.</p> <p>2. S.F.L. - STRUCTURAL FLOOR LEVEL.</p> <p>3. --- REVERSED DETAIL.</p> | <p>STRUCTURAL CONSULTANT: AECOM</p> <p>STRUCTURAL ENGINEER: Gammon</p> | <p>CLIENT: 信榮地產有限公司<br/>Sino Land Company Limited</p> <p>ARCHITECT: Ronald Lu &amp; Partners<br/>Ronald Lu &amp; Partners (HK) Ltd<br/>呂志榮建築師事務所(信榮)有限公司</p> | <p>BA. REF: T1 AA, T1 BA</p> |
|  |   |                          |  |  |  |                              |

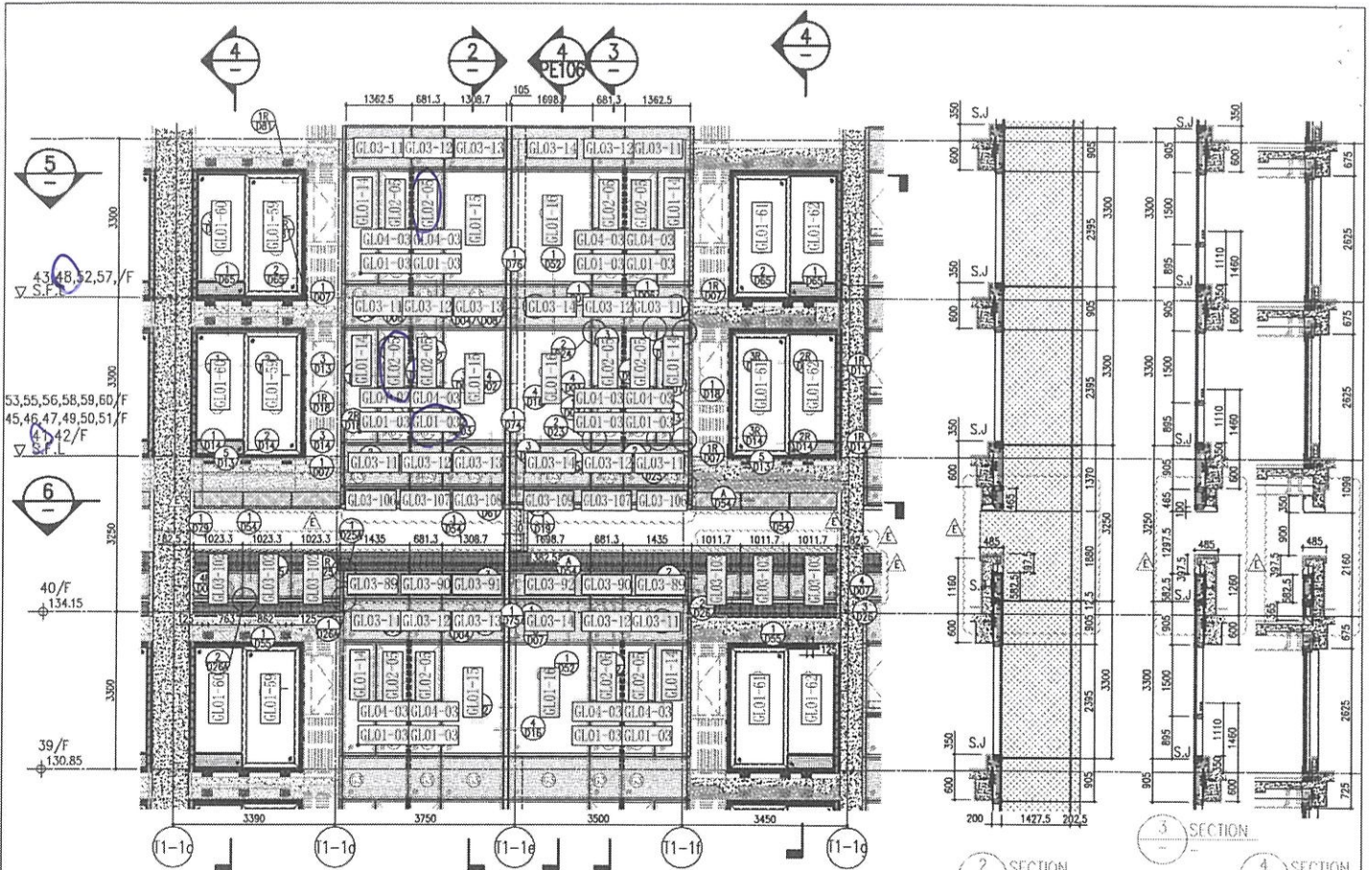

SECTION 2 SECTION 3 SECTION 4

|      |        |      |         |      |         |      |         |
|------|--------|------|---------|------|---------|------|---------|
| 26/F | +91.25 | 39/F | +130.85 | 52/F | +170.40 |      |         |
| 25/F | +87.95 | 38/F | +127.55 | 51/F | +167.10 | R/F  | +203.80 |
| 23/F | +84.65 | 37/F | +124.25 | 50/F | +163.80 | 62/F | +200.30 |
| 22/F | +81.35 | 36/F | +120.95 | 49/F | +160.50 | 61/F | +196.80 |
| 21/F | +78.05 | 35/F | +117.65 | 48/F | +157.20 | 60/F | +193.50 |
| 20/F | +74.75 | 33/F | +114.35 | 47/F | +153.90 | 59/F | +190.20 |
| 19/F | +71.45 | 32/F | +111.05 | 46/F | +150.60 | 58/F | +186.90 |
| 18/F | +68.15 | 31/F | +107.75 | 45/F | +147.30 | 57/F | +183.60 |
| 17/F | +64.85 | 30/F | +104.45 | 43/F | +144.00 | 56/F | +180.30 |
| 16/F | +61.55 | 29/F | +101.15 | 42/F | +140.70 | 55/F | +177.00 |
| 15/F | +58.25 | 28/F | +97.85  | 41/F | +137.40 | 53/F | +173.70 |
| 12/F | +54.95 | 27/F | +94.55  | 40/F | +134.15 |      |         |

- LEGEND:
- 10mm THK. HEAT STRENGTHENED GLASS (OUTSIDE) + 12mm AIR SPACE + 12mm THK. TEMPERED GLASS
  - 10mm THK. HEAT STRENGTHENED GLASS (OUTSIDE) + 12mm AIR SPACE + 10mm THK. TEMPERED GLASS
  - 12mm THK. HEAT STRENGTHENED GLASS
  - 12mm THK. CLEAR TEMPERED GLASS (INTERNAL PROTECTIVE BARRIER)
  - 12mm CLEAR HEAT STRENGTHENED GLASS
  - 10mm THK. CLEAR TEMPERED GLASS
  - 8mm THK. CLEAR HEAT-STRENGTHENED GLASS + 1.52mm PVB + 8mm THK. CLEAR HEAT-STRENGTHENED GLASS
  - 3 mm THK. ALUM. CLADDING
  - 3 mm THK. ALUM. BACKPAN
  - STACK JOINT

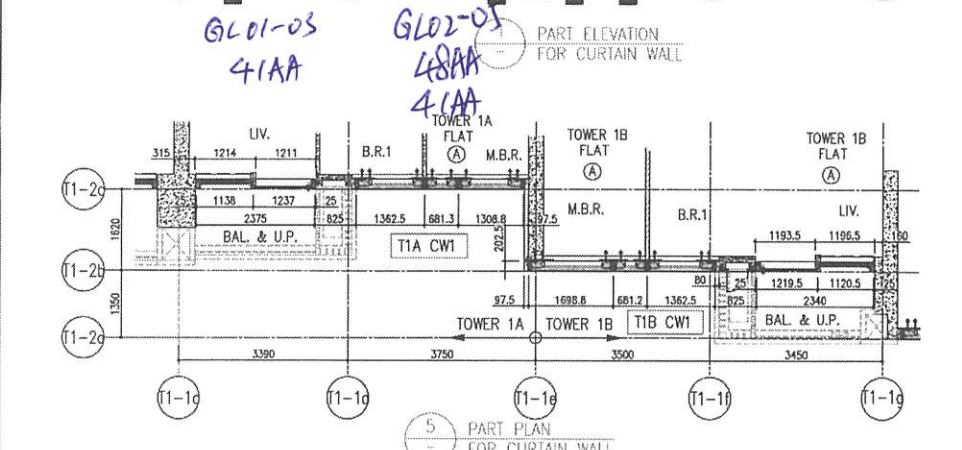

PROJECT: COMPOSITE RESIDENCIAL DEVELOPMENT AT 709P PARKWAY, PHASE 1, LIONS PARK, SEMANGI, KUALA LUMPUR, MALAYSIA.

DATE: 22-OCT-21 SCALE: 1:500(A1)

DRAWN BY: [Name] CHECKED BY: [Name]

PROJECT MANAGER: [Name]

ARCHITECT: [Name]

STRUCTURAL ENGINEER: [Name]

MECHANICAL ENGINEER: [Name]

ELECTRICAL ENGINEER: [Name]

PLUMBING ENGINEER: [Name]

LANDSCAPE ARCHITECT: [Name]

ENVIRONMENTAL ENGINEER: [Name]

SOIL ENGINEER: [Name]

TRAFFIC ENGINEER: [Name]

LEGAL CONSULTANT: [Name]

MARKETING CONSULTANT: [Name]

CLIENT: [Name]

ARCHITECT: [Name]

STRUCTURAL ENGINEER: [Name]

MECHANICAL ENGINEER: [Name]

ELECTRICAL ENGINEER: [Name]

PLUMBING ENGINEER: [Name]

LANDSCAPE ARCHITECT: [Name]

ENVIRONMENTAL ENGINEER: [Name]

SOIL ENGINEER: [Name]

TRAFFIC ENGINEER: [Name]

LEGAL CONSULTANT: [Name]

MARKETING CONSULTANT: [Name]

CLIENT: [Name]

ARCHITECT: [Name]

STRUCTURAL ENGINEER: [Name]

MECHANICAL ENGINEER: [Name]

ELECTRICAL ENGINEER: [Name]

PLUMBING ENGINEER: [Name]

LANDSCAPE ARCHITECT: [Name]

ENVIRONMENTAL ENGINEER: [Name]

SOIL ENGINEER: [Name]

TRAFFIC ENGINEER: [Name]

LEGAL CONSULTANT: [Name]

MARKETING CONSULTANT: [Name]

CLIENT: [Name]

ARCHITECT: [Name]

STRUCTURAL ENGINEER: [Name]

MECHANICAL ENGINEER: [Name]

ELECTRICAL ENGINEER: [Name]

PLUMBING ENGINEER: [Name]

LANDSCAPE ARCHITECT: [Name]

ENVIRONMENTAL ENGINEER: [Name]

SOIL ENGINEER: [Name]

TRAFFIC ENGINEER: [Name]

LEGAL CONSULTANT: [Name]

MARKETING CONSULTANT: [Name]

CLIENT: [Name]

ARCHITECT: [Name]

STRUCTURAL ENGINEER: [Name]

MECHANICAL ENGINEER: [Name]

ELECTRICAL ENGINEER: [Name]

PLUMBING ENGINEER: [Name]

LANDSCAPE ARCHITECT: [Name]

ENVIRONMENTAL ENGINEER: [Name]

SOIL ENGINEER: [Name]

TRAFFIC ENGINEER: [Name]

LEGAL CONSULTANT: [Name]

MARKETING CONSULTANT: [Name]

CLIENT: [Name]

ARCHITECT: [Name]

STRUCTURAL ENGINEER: [Name]

MECHANICAL ENGINEER: [Name]

ELECTRICAL ENGINEER: [Name]

PLUMBING ENGINEER: [Name]

LANDSCAPE ARCHITECT: [Name]

ENVIRONMENTAL ENGINEER: [Name]

SOIL ENGINEER: [Name]

TRAFFIC ENGINEER: [Name]

LEGAL CONSULTANT: [Name]

MARKETING CONSULTANT: [Name]

CLIENT: [Name]

ARCHITECT: [Name]

STRUCTURAL ENGINEER: [Name]

MECHANICAL ENGINEER: [Name]

ELECTRICAL ENGINEER: [Name]

PLUMBING ENGINEER: [Name]

LANDSCAPE ARCHITECT: [Name]

ENVIRONMENTAL ENGINEER: [Name]

SOIL ENGINEER: [Name]

TRAFFIC ENGINEER: [Name]

LEGAL CONSULTANT: [Name]

MARKETING CONSULTANT: [Name]

CLIENT: [Name]

ARCHITECT: [Name]

STRUCTURAL ENGINEER: [Name]

MECHANICAL ENGINEER: [Name]

ELECTRICAL ENGINEER: [Name]

PLUMBING ENGINEER: [Name]

LANDSCAPE ARCHITECT: [Name]

ENVIRONMENTAL ENGINEER: [Name]

SOIL ENGINEER: [Name]

TRAFFIC ENGINEER: [Name]

LEGAL CONSULTANT: [Name]

MARKETING CONSULTANT: [Name]

CLIENT: [Name]

ARCHITECT: [Name]

STRUCTURAL ENGINEER: [Name]

MECHANICAL ENGINEER: [Name]

ELECTRICAL ENGINEER: [Name]

PLUMBING ENGINEER: [Name]

LANDSCAPE ARCHITECT: [Name]

ENVIRONMENTAL ENGINEER: [Name]

SOIL ENGINEER: [Name]

TRAFFIC ENGINEER: [Name]

LEGAL CONSULTANT: [Name]

MARKETING CONSULTANT: [Name]

CLIENT: [Name]

ARCHITECT: [Name]

STRUCTURAL ENGINEER: [Name]

MECHANICAL ENGINEER: [Name]

ELECTRICAL ENGINEER: [Name]

PLUMBING ENGINEER: [Name]

LANDSCAPE ARCHITECT: [Name]

ENVIRONMENTAL ENGINEER: [Name]

SOIL ENGINEER: [Name]

TRAFFIC ENGINEER: [Name]

LEGAL CONSULTANT: [Name]

MARKETING CONSULTANT: [Name]

CLIENT: [Name]

ARCHITECT: [Name]

STRUCTURAL ENGINEER: [Name]

MECHANICAL ENGINEER: [Name]

ELECTRICAL ENGINEER: [Name]

PLUMBING ENGINEER: [Name]

LANDSCAPE ARCHITECT: [Name]

ENVIRONMENTAL ENGINEER: [Name]

SOIL ENGINEER: [Name]

TRAFFIC ENGINEER: [Name]

LEGAL CONSULTANT: [Name]

MARKETING CONSULTANT: [Name]

CLIENT: [Name]

ARCHITECT: [Name]

STRUCTURAL ENGINEER: [Name]

MECHANICAL ENGINEER: [Name]

ELECTRICAL ENGINEER: [Name]

PLUMBING ENGINEER: [Name]

LANDSCAPE ARCHITECT: [Name]

ENVIRONMENTAL ENGINEER: [Name]

SOIL ENGINEER: [Name]

TRAFFIC ENGINEER: [Name]

LEGAL CONSULTANT: [Name]

MARKETING CONSULTANT: [Name]

CLIENT: [Name]

ARCHITECT: [Name]

STRUCTURAL ENGINEER: [Name]

MECHANICAL ENGINEER: [Name]

ELECTRICAL ENGINEER: [Name]

PLUMBING ENGINEER: [Name]

LANDSCAPE ARCHITECT: [Name]

ENVIRONMENTAL ENGINEER: [Name]

SOIL ENGINEER: [Name]

TRAFFIC ENGINEER: [Name]

LEGAL CONSULTANT: [Name]

MARKETING CONSULTANT: [Name]

CLIENT: [Name]

ARCHITECT: [Name]

STRUCTURAL ENGINEER: [Name]

MECHANICAL ENGINEER: [Name]

ELECTRICAL ENGINEER: [Name]

PLUMBING ENGINEER: [Name]

LANDSCAPE ARCHITECT: [Name]

ENVIRONMENTAL ENGINEER: [Name]

SOIL ENGINEER: [Name]

TRAFFIC ENGINEER: [Name]

LEGAL CONSULTANT: [Name]

MARKETING CONSULTANT: [Name]

CLIENT: [Name]

ARCHITECT: [Name]

STRUCTURAL ENGINEER: [Name]

MECHANICAL ENGINEER: [Name]

ELECTRICAL ENGINEER: [Name]

PLUMBING ENGINEER: [Name]

LANDSCAPE ARCHITECT: [Name]

ENVIRONMENTAL ENGINEER: [Name]

SOIL ENGINEER: [Name]

TRAFFIC ENGINEER: [Name]

LEGAL CONSULTANT: [Name]

MARKETING CONSULTANT: [Name]

CLIENT: [Name]

ARCHITECT: [Name]

STRUCTURAL ENGINEER: [Name]

MECHANICAL ENGINEER: [Name]

ELECTRICAL ENGINEER: [Name]

PLUMBING ENGINEER: [Name]

LANDSCAPE ARCHITECT: [Name]

ENVIRONMENTAL ENGINEER: [Name]

SOIL ENGINEER: [Name]

TRAFFIC ENGINEER: [Name]

LEGAL CONSULTANT: [Name]

MARKETING CONSULTANT: [Name]

CLIENT: [Name]

ARCHITECT: [Name]

STRUCTURAL ENGINEER: [Name]

MECHANICAL ENGINEER: [Name]

ELECTRICAL ENGINEER: [Name]

PLUMBING ENGINEER: [Name]

LANDSCAPE ARCHITECT: [Name]

ENVIRONMENTAL ENGINEER: [Name]

SOIL ENGINEER: [Name]

TRAFFIC ENGINEER: [Name]

LEGAL CONSULTANT: [Name]

MARKETING CONSULTANT: [Name]

CLIENT: [Name]

ARCHITECT: [

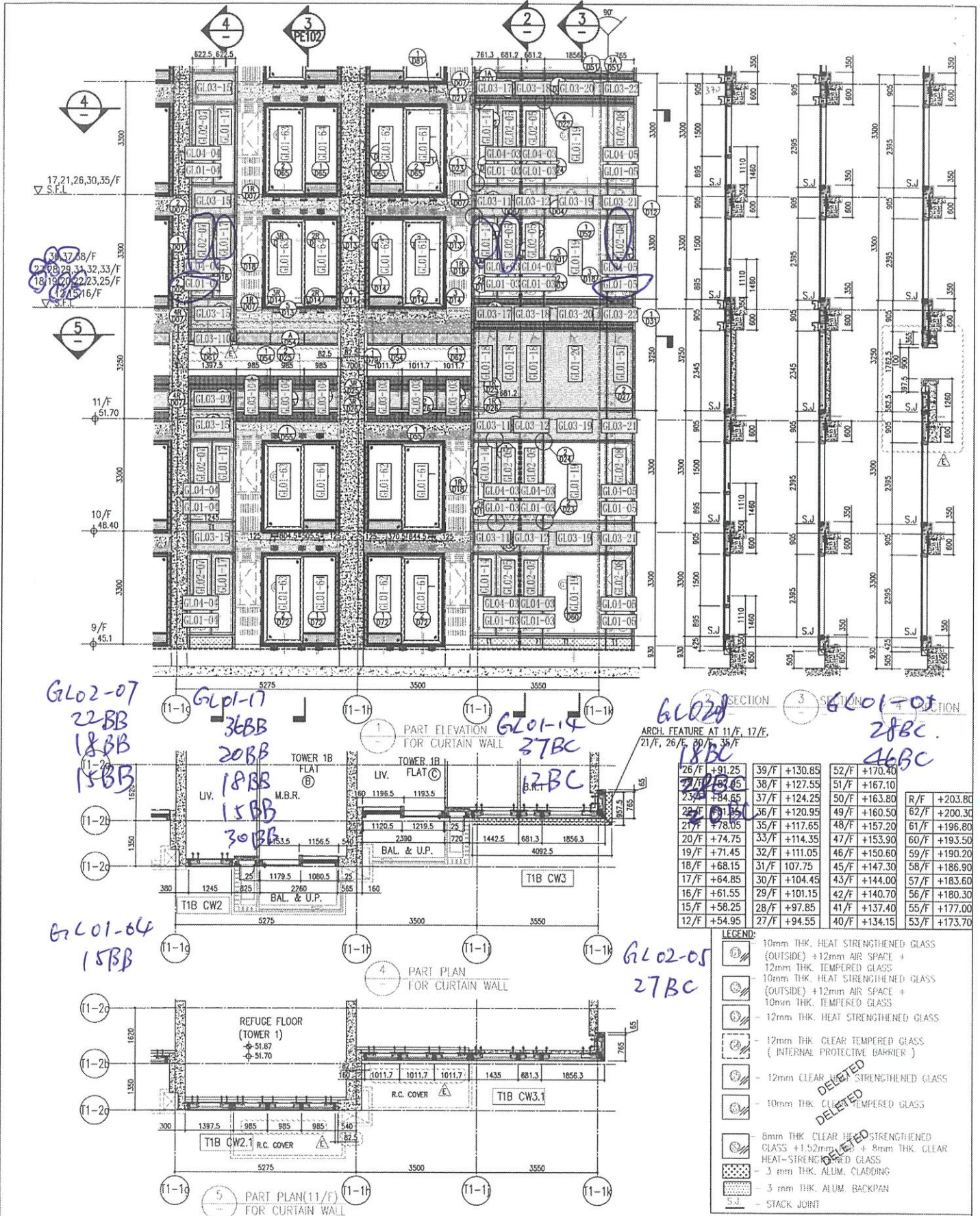

**PROJECT:** PROPOSED RESIDENTIAL DEVELOPMENT AT TOWER 20th FLOOR PHASE 11, LIONS PARK TOWER 11, W. N.T.

**CLIENT:** 盈地置業有限公司  
Sino Land Company Limited

**ARCHITECT:** Ronald Lu & Partners  
Ronald Lu & Partners (HK) Ltd.  
香港建築師學會會員有限公司

**STRUCTURAL ENGINEER:** Gammon

**FAÇADE CONSULTING:** AECOM

**SCALE:** 1:500(A1)

**DATE:** 22-07-21

**PROJECT NO.:** J-858

**DRAWN BY:** [Name]

**CHECKED BY:** [Name]

**REVISIONS:**

| NO. | DATE     | REVISION                |
|-----|----------|-------------------------|
| 1   | 23/07/21 | REVISED AS PER COMMENTS |
| 2   | 06/08/21 | REVISED AS PER COMMENTS |
| 3   | 24/07/21 | REVISED AS PER COMMENTS |
| 4   | 20/12/21 | REVISED AS PER COMMENTS |
| 5   | 02/12/21 | REVISED AS PER COMMENTS |

**LEGEND:**

- 1. ALL DIMENSIONS ARE IN mm.
- 2. ALL DIMENSIONS ARE MEASURED FROM OUTSIDE.
- 3. DIMENSIONS TO BE CHECKED ON SITE BEFORE CONSTRUCTION.
- 4. DETAIL WORK NO. REFER SHEET NO.
- 5. FEEL - FINISHED FLOOR LEVEL.
- 6. S.F.L. - STRUCTURAL FLOOR LEVEL.
- 7. REVERSED DETAIL.

**LEGEND (GLASS):**

- 10mm THK. HEAT STRENGTHENED GLASS (OUTSIDE) + 12mm AIR SPACE + 12mm THK. TEMPERED GLASS
- 10mm THK. HEAT STRENGTHENED GLASS (OUTSIDE) + 12mm AIR SPACE + 10mm THK. TEMPERED GLASS
- 12mm THK. HEAT STRENGTHENED GLASS
- 12mm THK. CLEAR TEMPERED GLASS (INTERNAL PROTECTIVE BARRIER)
- 12mm CLEAR HEAT STRENGTHENED GLASS
- 10mm THK. CLEAR TEMPERED GLASS
- 5mm THK. CLEAR HEAT STRENGTHENED GLASS + 1.52mm AIR SPACE + 8mm THK. CLEAR HEAT-STRENGTHENED GLASS
- 3 mm THK. ALUM. CLADDING
- 3 mm THK. ALUM. BACKPAN
- STACK JOINT

**REVISIONS:**

- DELETED
- DELETED
- DELETED

**Handwritten Notes:** T1 BB, T1 BC

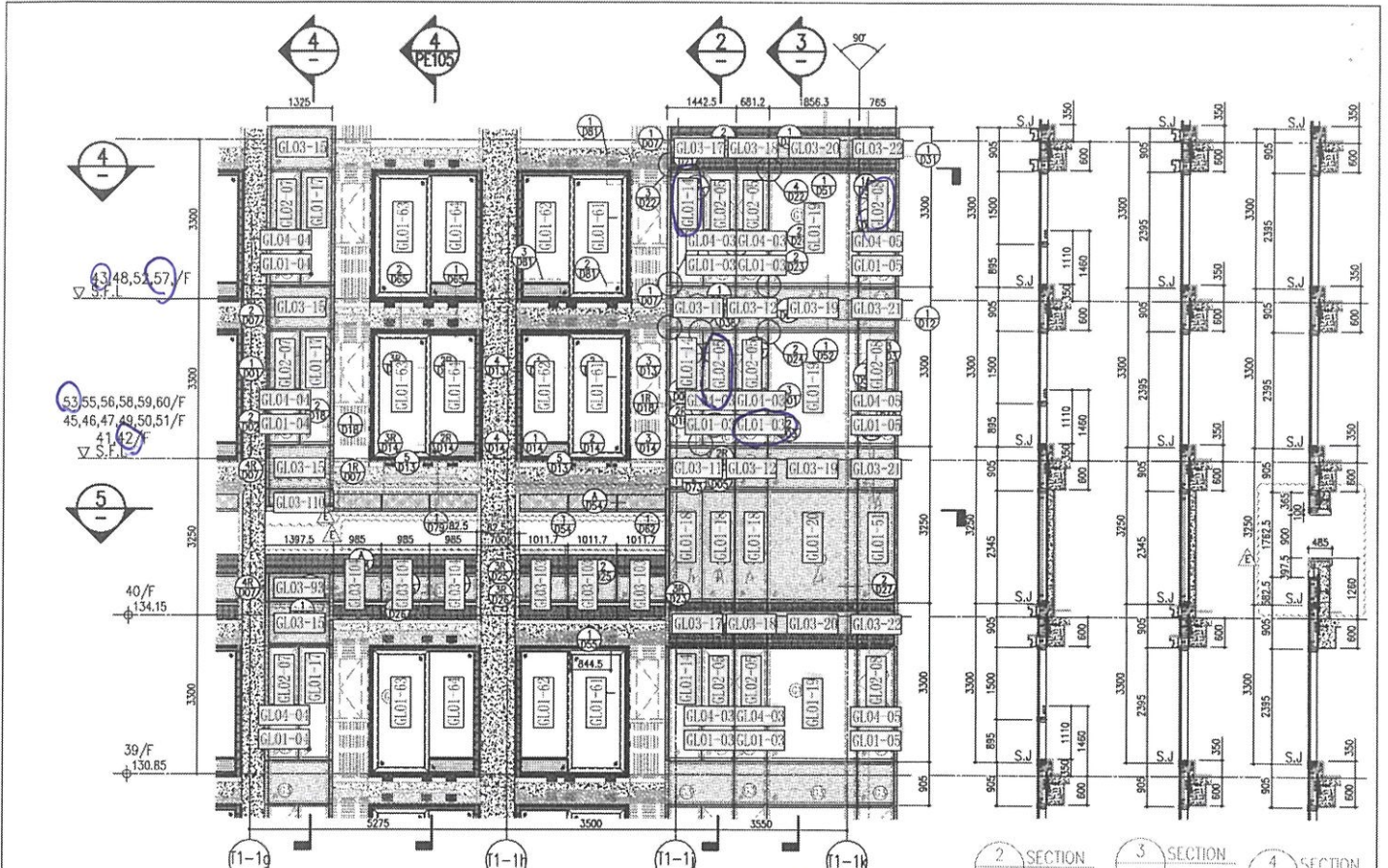

1 PART ELEVATION FOR CURTAIN WALL  
 GL04-04 GL01-03  
 57BC 53BC

2 SECTION 3 SECTION 4 SECTION  
 GL02-08 GL02-05  
 43BC 42BC

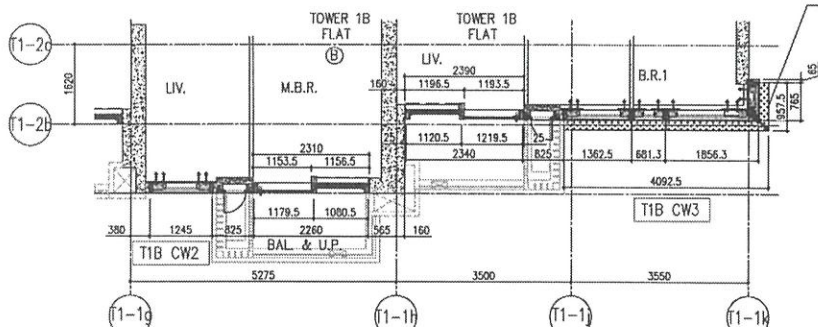

4 PART PLAN FOR CURTAIN WALL

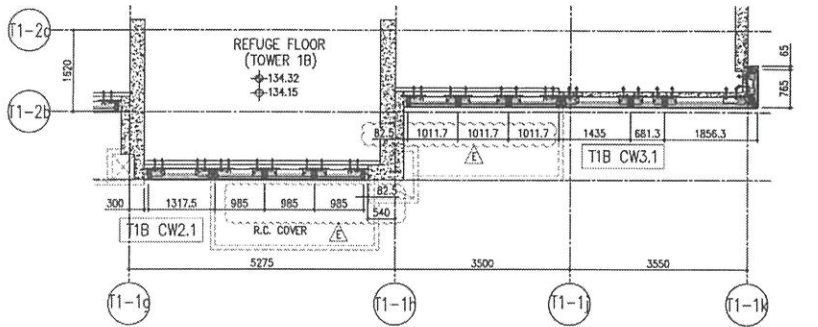

5 PART PLAN (40/F) FOR CURTAIN WALL

ARCH. FEATURE AT 39/F, 43/F, 48/F, 52/F, 57/F

|             |              |              |              |
|-------------|--------------|--------------|--------------|
| 26/F +91.25 | 39/F +130.85 | 52/F +170.40 |              |
| 25/F +87.95 | 38/F +127.55 | 51/F +167.10 |              |
| 23/F +84.65 | 37/F +124.25 | 50/F +163.80 | R/F +203.80  |
| 22/F +81.35 | 36/F +120.95 | 49/F +160.50 | 62/F +200.30 |
| 21/F +78.05 | 35/F +117.65 | 48/F +157.20 | 61/F +196.80 |
| 20/F +74.75 | 33/F +114.35 | 47/F +153.90 | 60/F +193.50 |
| 19/F +71.45 | 32/F +111.05 | 46/F +150.60 | 59/F +190.20 |
| 18/F +68.15 | 31/F 107.75  | 45/F +147.30 | 58/F +186.90 |
| 17/F +64.85 | 30/F +104.45 | 43/F +144.00 | 57/F +183.60 |
| 16/F +61.55 | 29/F +101.15 | 42/F +140.70 | 56/F +180.30 |
| 15/F +58.25 | 28/F +97.85  | 41/F +137.40 | 55/F +177.00 |
| 12/F +54.95 | 27/F +94.55  | 40/F +134.15 | 53/F +173.70 |

- LEGEND:
- 10mm THK. HEAT STRENGTHENED GLASS (OUTSIDE) + 12mm AIR SPACE + 12mm THK. TEMPERED GLASS
  - 10mm THK. HEAT STRENGTHENED GLASS (OUTSIDE) + 12mm AIR SPACE + 10mm THK. TEMPERED GLASS
  - 12mm THK. HEAT STRENGTHENED GLASS
  - 12mm THK. CLEAR TEMPERED GLASS (INTERNAL PROTECTIVE BARRIER)
  - 12mm CLEAR TEMPERED STRENGTHENED GLASS
  - 10mm THK. CLEAR TEMPERED GLASS
  - 8mm THK. CLEAR HEAT-STRENGTHENED GLASS + 1.5mm PVB + 8mm THK. CLEAR HEAT-STRENGTHENED GLASS
  - 3 mm THK. ALUM. CLADDING
  - 3 mm THK ALUM. BACKPAN
  - STACK JOINT

DATE: 22-07-21 SCALE: 1:50(A1)  
 DRAWN BY: [Name]  
 CHECKED BY: [Name]  
 PROJECT: PROPOSED RESIDENTIAL DEVELOPMENT AT TOWER 208, PHASE 11, LOMAS PARK, TSEUNG KWAN O, N.T.
 TITLE: TYPICAL FLOOR PARTIAL ELEVATION & SECTION, PLAN FOR CURTAIN WALL (TOWER 1)
 JOB NO.: J-858  
 DRAWING NO.: J-858-CW-PE106  
 REV.: E

| NO. | DATE     | REVISION                |
|-----|----------|-------------------------|
| 1   | 22/07/21 | ISSUED AS PER COMMENTS  |
| 2   | 06/08/22 | REVISED AS PER COMMENTS |
| 3   | 24/07/22 | REVISED AS PER COMMENTS |
| 4   | 20/12/21 | REVISED AS PER COMMENTS |
| 5   | 02/12/21 | REVISED AS PER COMMENTS |

NOTE:  
 1. ALL DIMENSIONS ARE IN MM.  
 2. ALL DIMENSIONS TO BE CHECKED ON SITE.  
 3. REVERSE FABRICATION.  
 LEGEND:  
 (1) DETAIL MARK NO.  
 (2) REFER SHEET NO.  
 1. F.F.L. - FINISHED FLOOR LEVEL  
 2. S.F.L. - STRUCTURAL FLOOR LEVEL  
 3. - REVERSED DETAIL

STRUCTURAL ENGINEER:  
**AECOM**  
**Gammon**

ARCHITECT:  
**AECOM**  
**Gammon**

CLIENT:  
 信和置業有限公司  
 Sino Land Company Limited

ARCHITECT:  
 Ronald Lu & Partners  
 Ronald Lu & Partners (HK) Ltd.  
 呂元仲建築師事務所(香港)有限公司  
 MAIN CONTRACTOR:  
 [Name]

BD REF: T1BB  
 T1BC

REVISIONS:  
 [Table with revision details]



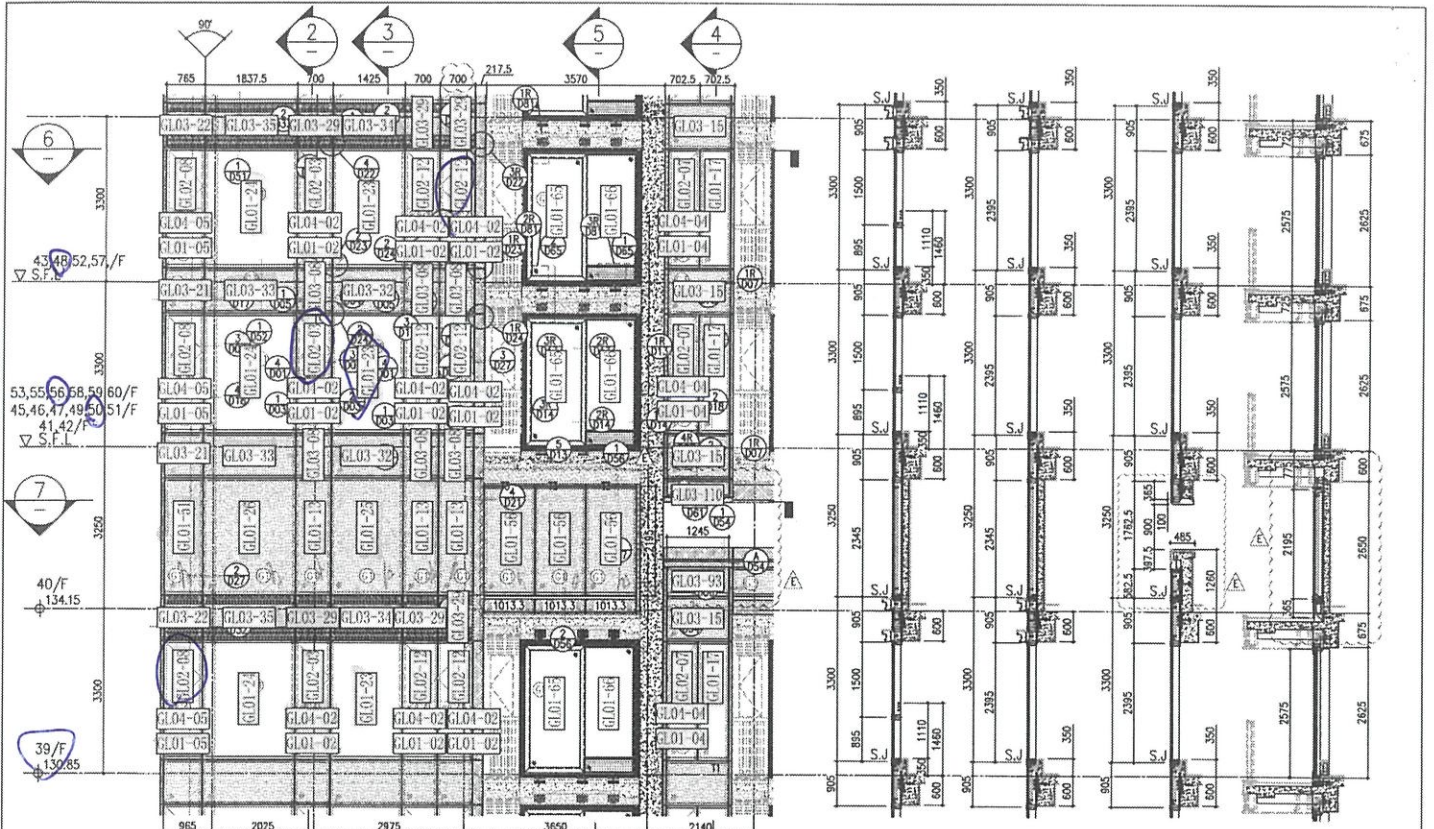

2 SECTION 3 SECTION 4 SECTION 5 SECTION

G1.02-08 39 BD  
 ARCH. FEATURE AT 39/F, 43/F, 48/F, 52/F, 57/F  
 G1.02-02 56 BD  
 G1.01-23 50 BD  
 G1.02-12 48 BD

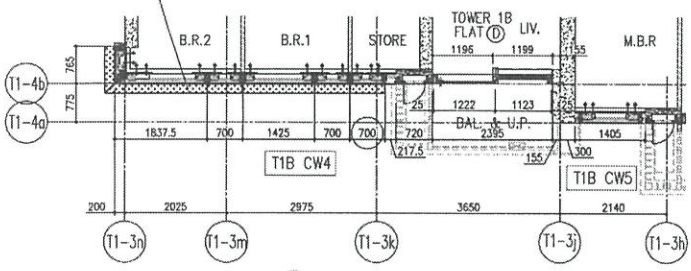

6 PART PLAN FOR CURTAIN WALL

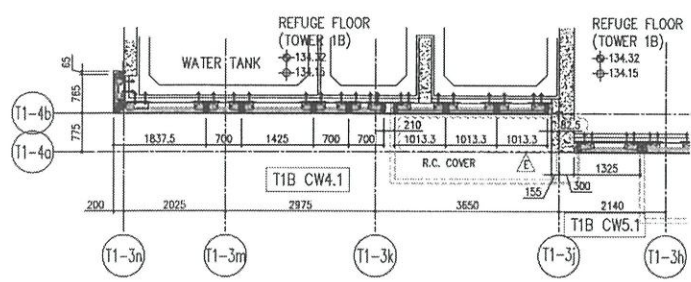

7 PART PLAN(40/F) FOR CURTAIN WALL

|             |              |              |              |
|-------------|--------------|--------------|--------------|
| 26/F +91.25 | 39/F +130.85 | 52/F +170.40 |              |
| 25/F +87.95 | 38/F +127.55 | 51/F +167.10 |              |
| 23/F +84.65 | 37/F +124.25 | 50/F +163.80 | R/F +203.80  |
| 22/F +81.35 | 36/F +120.95 | 49/F +160.50 | 62/F +200.30 |
| 21/F +78.05 | 35/F +117.65 | 48/F +157.20 | 61/F +196.80 |
| 20/F +74.75 | 33/F +114.35 | 47/F +153.90 | 60/F +193.50 |
| 19/F +71.45 | 32/F +111.05 | 46/F +150.60 | 59/F +190.20 |
| 18/F +68.15 | 31/F +107.75 | 45/F +147.30 | 58/F +186.90 |
| 17/F +64.85 | 30/F +104.45 | 43/F +144.00 | 57/F +183.60 |
| 16/F +61.55 | 29/F +101.15 | 42/F +140.70 | 56/F +180.30 |
| 15/F +58.25 | 28/F +97.85  | 41/F +137.40 | 55/F +177.00 |
| 12/F +54.95 | 27/F +94.55  | 40/F +134.15 | 53/F +173.70 |

**LEGEND:**

- 10mm THK. HEAT STRENGTHENED GLASS (OUTSIDE) +12mm AIR SPACE + 12mm THK. TEMPERED GLASS
- 10mm THK. HEAT STRENGTHENED GLASS (OUTSIDE) +12mm AIR SPACE + 10mm THK. TEMPERED GLASS
- 12mm THK. HEAT STRENGTHENED GLASS
- 12mm THK. CLEAR TEMPERED GLASS (INTERNAL PROTECTIVE BARRIER)
- 12mm CLEAR STRENGTHENED GLASS
- 10mm THK. CLEAR TEMPERED GLASS
- 8mm THK. CLEAR STRENGTHENED GLASS +1.52mm PVB + 8mm THK. CLEAR HEAT-STRENGTHENED GLASS
- 3 mm THK. ALUM. GLAZING
- 3 mm THK ALUM BACKPAN
- STACK JOINT

DATE: 22-07-21  
 SCALE: 1:50(A1)  
 PROJECT: PROPOSED RESIDENTIAL DEVELOPMENT AT TOWER 20/F, PHASE 11, LIONS PARK, TSEUNG WAN N, N.T.  
 DRAWN BY: [Name]  
 CHECKED BY: [Name]

|          |  |            |          |
|----------|--|------------|----------|
| DATE     | 22-07-21   | SCALE      | 1:50(A1) |
| PROJECT  | PROPOSED RESIDENTIAL DEVELOPMENT AT TOWER 20/F, PHASE 11, LIONS PARK, TSEUNG WAN N, N.T. |            |          |
| DRAWN BY | [Name]   | CHECKED BY | [Name]   |

|     |          |                         |
|-----|----------|-------------------------|
| NO. | DATE     | REVISION                |
| 1   | 09/07/22 | REVISED AS PER COMMENTS |
| 2   | 16/07/22 | REVISED AS PER COMMENTS |
| 3   | 16/07/22 | REVISED AS PER COMMENTS |
| 4   | 16/07/22 | REVISED AS PER COMMENTS |
| 5   | 16/07/22 | REVISED AS PER COMMENTS |
| 6   | 16/07/22 | REVISED AS PER COMMENTS |
| 7   | 16/07/22 | REVISED AS PER COMMENTS |
| 8   | 16/07/22 | REVISED AS PER COMMENTS |
| 9   | 16/07/22 | REVISED AS PER COMMENTS |
| 10  | 16/07/22 | REVISED AS PER COMMENTS |

**NOTE:**  
 1. ALL DIMENSIONS ARE IN mm.  
 2. ALL DIMENSIONS ARE REFERRED FROM OUTSIDE.  
 3. ALL DIMENSIONS TO BE REFERRED ON SITE BEFORE FABRICATION.  
**LEGEND:**  
 (X) DETAIL WORK NO.  
 (---) REFER SHEET NO.  
 (---) FINISHED FLOOR LEVEL  
 (---) STRUCTURAL FLOOR LEVEL  
 (---) REVERSED DETAIL

PROJECT CONSULTANT: **AECOM**  
 STRUCTURAL ENGINEER: **Gammion**  
 ARCHITECT: Ronald Yu & Partners  
 CLIENT: Sino Land Company Limited  
 BUILDING NO.: T1 BD, T1 BE

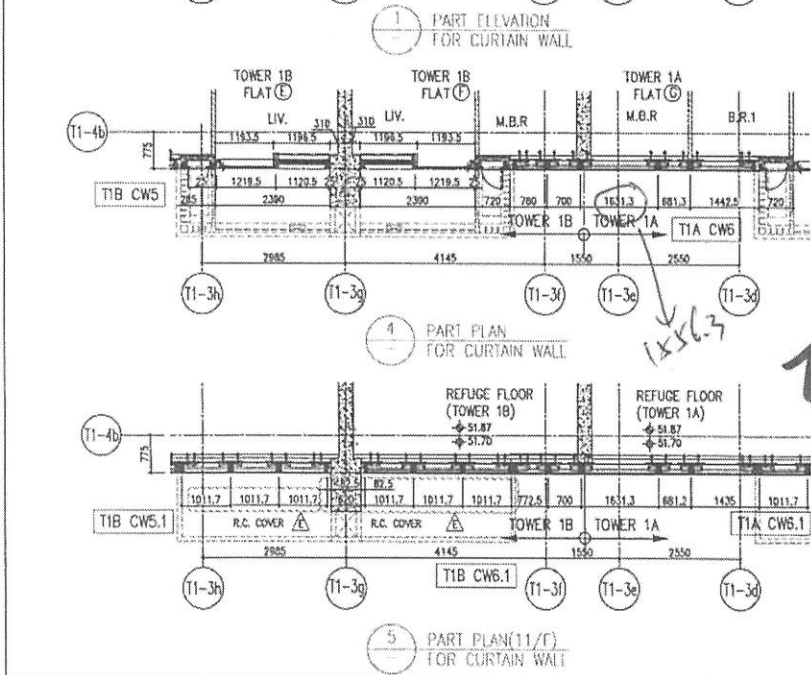
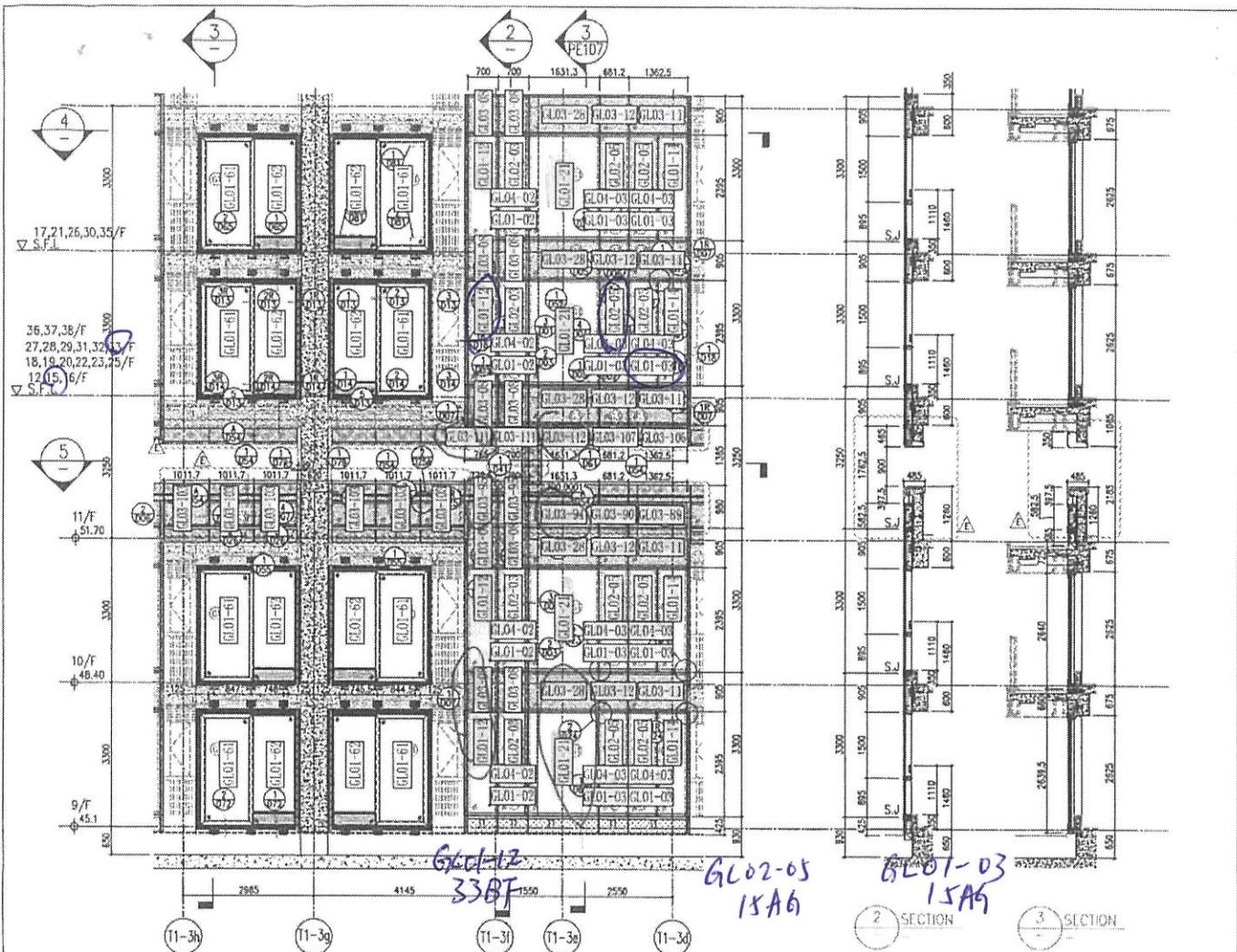

|      |        |      |         |      |         |      |         |
|------|--------|------|---------|------|---------|------|---------|
| 26/F | +91.25 | 39/F | +130.85 | 52/F | +170.40 |      |         |
| 25/F | +87.95 | 38/F | +127.55 | 51/F | +167.10 | R/F  | +203.80 |
| 23/F | +84.65 | 37/F | +124.25 | 50/F | +163.80 | 62/F | +200.30 |
| 22/F | +81.35 | 36/F | +120.95 | 49/F | +160.50 | 61/F | +196.80 |
| 21/F | +78.05 | 35/F | +117.65 | 48/F | +157.20 | 60/F | +193.50 |
| 20/F | +74.75 | 33/F | +114.35 | 47/F | +153.90 | 59/F | +190.20 |
| 19/F | +71.45 | 32/F | +111.05 | 46/F | +150.60 | 58/F | +186.90 |
| 18/F | +68.15 | 31/F | +107.75 | 45/F | +147.30 | 57/F | +183.60 |
| 17/F | +64.85 | 30/F | +104.45 | 43/F | +144.00 | 56/F | +180.30 |
| 16/F | +61.55 | 29/F | +101.15 | 42/F | +140.70 | 55/F | +177.00 |
| 15/F | +58.25 | 28/F | +97.85  | 41/F | +137.40 |      |         |
| 12/F | +51.65 | 27/F | +94.55  | 40/F | +134.15 |      |         |

- LEGEND:**
- 10mm THK. HEAT STRENGTHENED GLASS (OUTSIDE) + 12mm AIR SPACE + 12mm THK TEMPERED GLASS
  - 10mm THK. HEAT STRENGTHENED GLASS (OUTSIDE) + 12mm AIR SPACE + 10mm THK. TEMPERED GLASS
  - 12mm THK. HEAT STRENGTHENED GLASS (INTERNAL PROTECTIVE BARRIER)
  - 12mm CLEAR HEAT STRENGTHENED GLASS
  - 10mm THK. CLEAR TEMPERED GLASS
  - 6mm THK. CLEAR HEAT-STRENGTHENED GLASS + 12mm PVB + 6mm THK CLEAR HEAT-STRENGTHENED GLASS
  - 3 mm THK. ALUM. CLADDING
  - 3 mm THK ALUM BACKPAN
  - S-J - STACK JOINT

| <p><b>DATE:</b> 21-07-11</p> <p><b>SCALE:</b> 1:50(A1)</p> <p><b>TITLE:</b> TYPICAL FLOOR PARTIAL ELEVATION &amp; SECTION, PLAN FOR CURTAIN WALL (TOWER 1)</p> <p><b>PROJECT:</b> PROPOSED RESIDENTIAL DEVELOPMENT AT TOWER 1, LEUNG PARK TRADING KIAN Q. N.T.</p> <p><b>CLIENT:</b> J-858</p> <p><b>DESIGNED BY:</b> [Signature]</p> <p><b>DATE:</b> 21-07-11</p> <p><b>SCALE:</b> 1:50(A1)</p> <p><b>TITLE:</b> TYPICAL FLOOR PARTIAL ELEVATION &amp; SECTION, PLAN FOR CURTAIN WALL (TOWER 1)</p> <p><b>PROJECT:</b> PROPOSED RESIDENTIAL DEVELOPMENT AT TOWER 1, LEUNG PARK TRADING KIAN Q. N.T.</p> <p><b>CLIENT:</b> J-858</p> <p><b>DESIGNED BY:</b> [Signature]</p> | <p><b>REVISIONS:</b></p> <table border="1"> <tr> <th>NO.</th> <th>DATE</th> <th>REVISION</th> </tr> <tr> <td>1</td> <td>21/07/11</td> <td>ISSUED AS PER CONDITIONS</td> </tr> <tr> <td>2</td> <td>21/07/11</td> <td>REVISED AS PER COMMENTS</td> </tr> <tr> <td>3</td> <td>21/07/11</td> <td>REVISED AS PER COMMENTS</td> </tr> <tr> <td>4</td> <td>21/07/11</td> <td>REVISED AS PER COMMENTS</td> </tr> <tr> <td>5</td> <td>21/07/11</td> <td>REVISED AS PER COMMENTS</td> </tr> </table> | NO.                      | DATE | REVISION | 1 | 21/07/11 | ISSUED AS PER CONDITIONS | 2 | 21/07/11 | REVISED AS PER COMMENTS | 3 | 21/07/11 | REVISED AS PER COMMENTS | 4 | 21/07/11 | REVISED AS PER COMMENTS | 5 | 21/07/11 | REVISED AS PER COMMENTS | <p><b>NOTES:</b></p> <ol style="list-style-type: none"> <li>ALL DIMENSIONS ARE IN MM.</li> <li>ALL DIMENSIONS ARE VIEWED FROM OUTSIDE.</li> <li>ALL DIMENSIONS TO BE VIEWED ON SITE.</li> <li>SEE ARCHITECTURAL DRAWINGS.</li> </ol> <p><b>LEGEND:</b></p> <ul style="list-style-type: none"> <li>1 - REFERENCE SYMBOL NO.</li> <li>2 - REFERENCE SYMBOL NO.</li> <li>3 - FINISHED FLOOR LEVEL</li> <li>4 - STRUCTURAL FLOOR LEVEL</li> <li>5 - REFERENCE SYMBOL</li> </ul> | <p><b>STRUCTURAL ENGINEER:</b> AECOM</p> <p><b>ARCHITECT:</b> GAMMON</p> <p><b>CLIENT:</b> 德利豐有限公司<br/>Sino Land Company Limited</p> <p><b>PROJECT:</b> Ronald Lu &amp; Partners (HK) Ltd.<br/>Ronald Lu &amp; Partners (HK) Ltd.<br/>利達建築師事務所(香港)有限公司</p> <p><b>MAIN CONTRACTOR:</b></p> | <p><b>DATE:</b> 21-07-11</p> <p><b>SCALE:</b> 1:50(A1)</p> <p><b>TITLE:</b> TYPICAL FLOOR PARTIAL ELEVATION &amp; SECTION, PLAN FOR CURTAIN WALL (TOWER 1)</p> <p><b>PROJECT:</b> PROPOSED RESIDENTIAL DEVELOPMENT AT TOWER 1, LEUNG PARK TRADING KIAN Q. N.T.</p> <p><b>CLIENT:</b> J-858</p> <p><b>DESIGNED BY:</b> [Signature]</p> <p><b>DATE:</b> 21-07-11</p> <p><b>SCALE:</b> 1:50(A1)</p> <p><b>TITLE:</b> TYPICAL FLOOR PARTIAL ELEVATION &amp; SECTION, PLAN FOR CURTAIN WALL (TOWER 1)</p> <p><b>PROJECT:</b> PROPOSED RESIDENTIAL DEVELOPMENT AT TOWER 1, LEUNG PARK TRADING KIAN Q. N.T.</p> <p><b>CLIENT:</b> J-858</p> <p><b>DESIGNED BY:</b> [Signature]</p> |
|---|--|--------------------------|------|----------|---|----------|--------------------------|---|----------|-------------------------|---|----------|-------------------------|---|----------|-------------------------|---|----------|-------------------------|---|---|---|
| NO.   | DATE   | REVISION                 |      |          |   |          |                          |   |          |                         |   |          |                         |   |          |                         |   |          |                         |   |   |   |
| 1   | 21/07/11   | ISSUED AS PER CONDITIONS |      |          |   |          |                          |   |          |                         |   |          |                         |   |          |                         |   |          |                         |   |   |   |
| 2   | 21/07/11   | REVISED AS PER COMMENTS  |      |          |   |          |                          |   |          |                         |   |          |                         |   |          |                         |   |          |                         |   |   |   |
| 3   | 21/07/11   | REVISED AS PER COMMENTS  |      |          |   |          |                          |   |          |                         |   |          |                         |   |          |                         |   |          |                         |   |   |   |
| 4   | 21/07/11   | REVISED AS PER COMMENTS  |      |          |   |          |                          |   |          |                         |   |          |                         |   |          |                         |   |          |                         |   |   |   |
| 5   | 21/07/11   | REVISED AS PER COMMENTS  |      |          |   |          |                          |   |          |                         |   |          |                         |   |          |                         |   |          |                         |   |   |   |

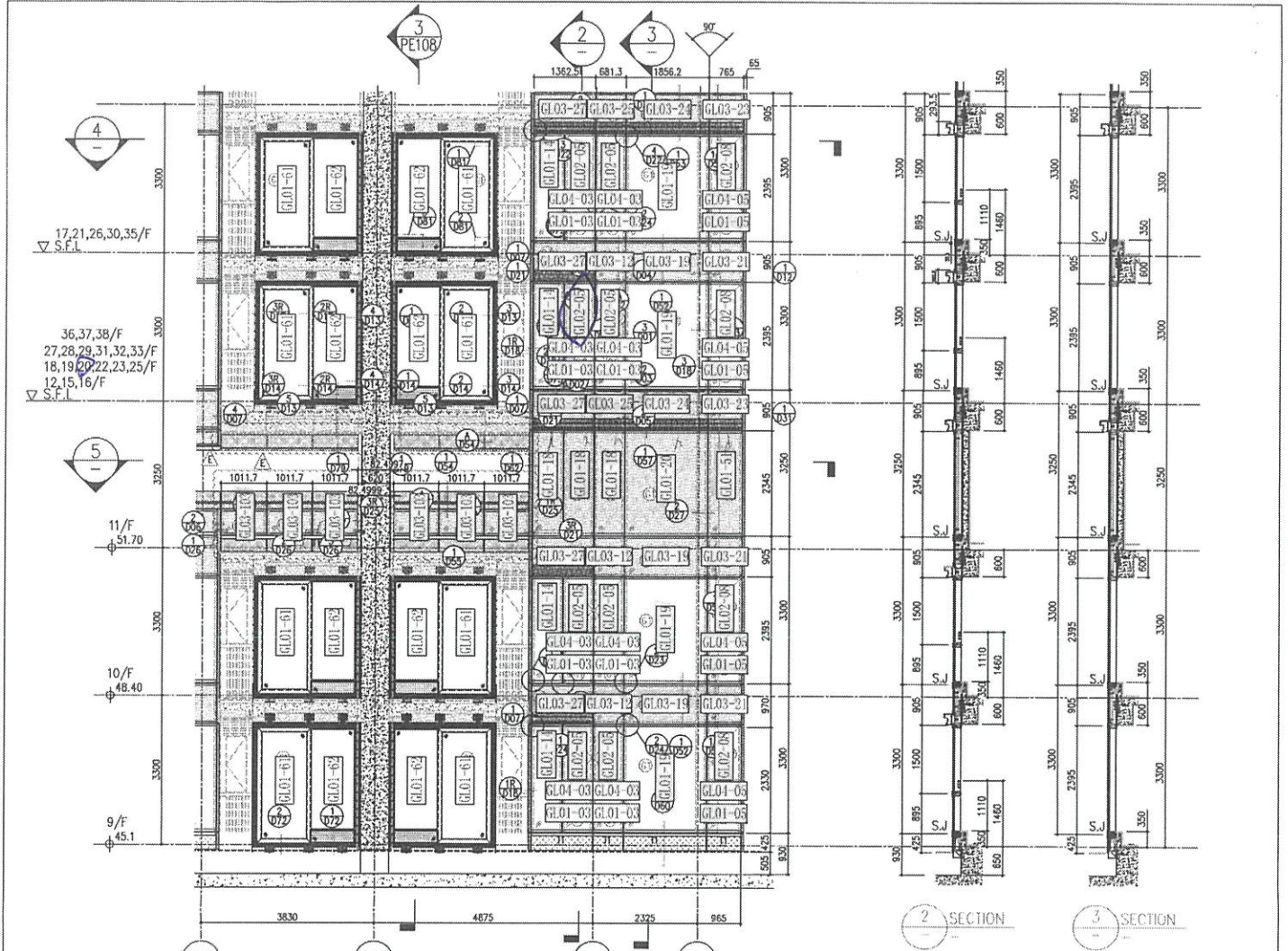

1 PART ELEVATION FOR CURTAIN WALL

*GL02-05  
20/F*

|      |        |      |         |      |         |      |         |
|------|--------|------|---------|------|---------|------|---------|
| 26/F | +91.25 | 39/F | +130.85 | 52/F | +170.40 |      |         |
| 25/F | +87.95 | 38/F | +127.55 | 51/F | +167.10 | R/F  | +203.80 |
| 23/F | +84.65 | 37/F | +124.25 | 50/F | +163.80 | 62/F | +200.30 |
| 22/F | +81.35 | 36/F | +120.95 | 49/F | +160.50 | 61/F | +196.80 |
| 21/F | +78.05 | 35/F | +117.65 | 48/F | +157.20 | 60/F | +193.50 |
| 20/F | +74.75 | 33/F | +114.35 | 47/F | +153.90 | 59/F | +190.20 |
| 19/F | +71.45 | 32/F | +111.05 | 46/F | +150.60 | 58/F | +186.90 |
| 18/F | +68.15 | 31/F | +107.75 | 45/F | +147.30 | 57/F | +183.60 |
| 17/F | +64.85 | 30/F | +104.45 | 43/F | +144.00 | 56/F | +180.30 |
| 16/F | +61.55 | 29/F | +101.15 | 42/F | +140.70 | 55/F | +177.00 |
| 15/F | +58.25 | 28/F | +97.85  | 41/F | +137.40 | 53/F | +173.70 |
| 12/F | +54.95 | 27/F | +94.55  | 40/F | +134.15 |      |         |

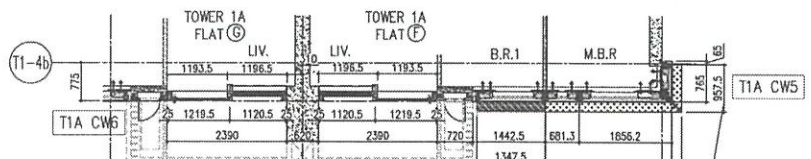

4 PART PLAN FOR CURTAIN WALL

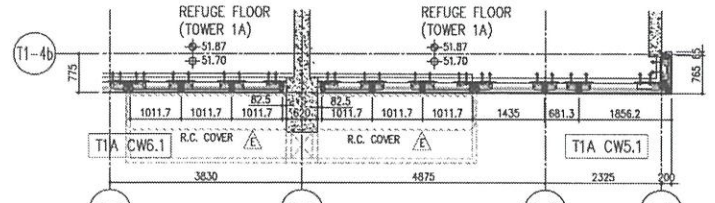

5 PART PLAN (11/F) FOR CURTAIN WALL

- LEGEND:**
- 10mm THK. HEAT STRENGTHENED GLASS (OUTSIDE) + 12mm AIR SPACE + 12mm THK. TEMPERED GLASS
  - 10mm THK. HEAT STRENGTHENED GLASS (OUTSIDE) + 12mm AIR SPACE + 10mm THK. TEMPERED GLASS
  - 12mm THK. HEAT STRENGTHENED GLASS
  - 12mm THK. CLEAR TEMPERED GLASS (INTERNAL PROTECTIVE BARRIER)
  - 12mm CLEAR HEAT STRENGTHENED GLASS
  - 10mm THK. CLEAR TEMPERED GLASS
  - 8mm THK. CLEAR STRENGTHENED GLASS + 12mm AIR + 8mm THK. CLEAR HEAT-STRENGTHENED GLASS
  - 3 mm THK. ALUM. CLADDING
  - 3 mm THK. ALUM. BACKPAN
  - STACK JOINT

DATE: 22-OCT-21  
SCALE: 1:50(A1)  
DRAWN BY: [Name]  
CHECKED BY: [Name]

TITLE: TYPICAL FLOOR PARTIAL ELEVATION & SECTION, PLAN FOR CURTAIN WALL (TOWER 1)

PROJECT: PROPOSED RESIDENTIAL DEVELOPMENT AT TOWER 709F, PHASE 11, LOKAS PARK, TSEUNG WAN Q. N.T.

JOB NO.: J-958

NOTES:

- ALL DIMENSIONS ARE IN MM.
- ALL DIMENSIONS ARE MEASURED FROM OUTSIDE FACE UNLESS OTHERWISE SPECIFIED.
- ALL DIMENSIONS ARE TO BE CHECKED ON SITE BEFORE PROCEEDING.

LEGEND:

- DETAIL MARK NO.
- REFER SHEET NO.
- F.F.L. - FINISHED FLOOR LEVEL
- S.F.L. - STRUCTURAL FLOOR LEVEL
- REVERSED DETAIL

PROJECT CONSULTANT: **AECOM**

STRUCTURAL ENGINEER: **Gammron**

ARCHITECT: **ronard lu & partners**

CLIENT: **Sino Land Company Limited**

UNIT 6-4, SUNG HAI INDUSTRIAL BUILDING, 510 Chee Koo Eng Road, Kowloon, HONG KONG

TEL: 23492111-4 FAX: 23492111-4

REV: E



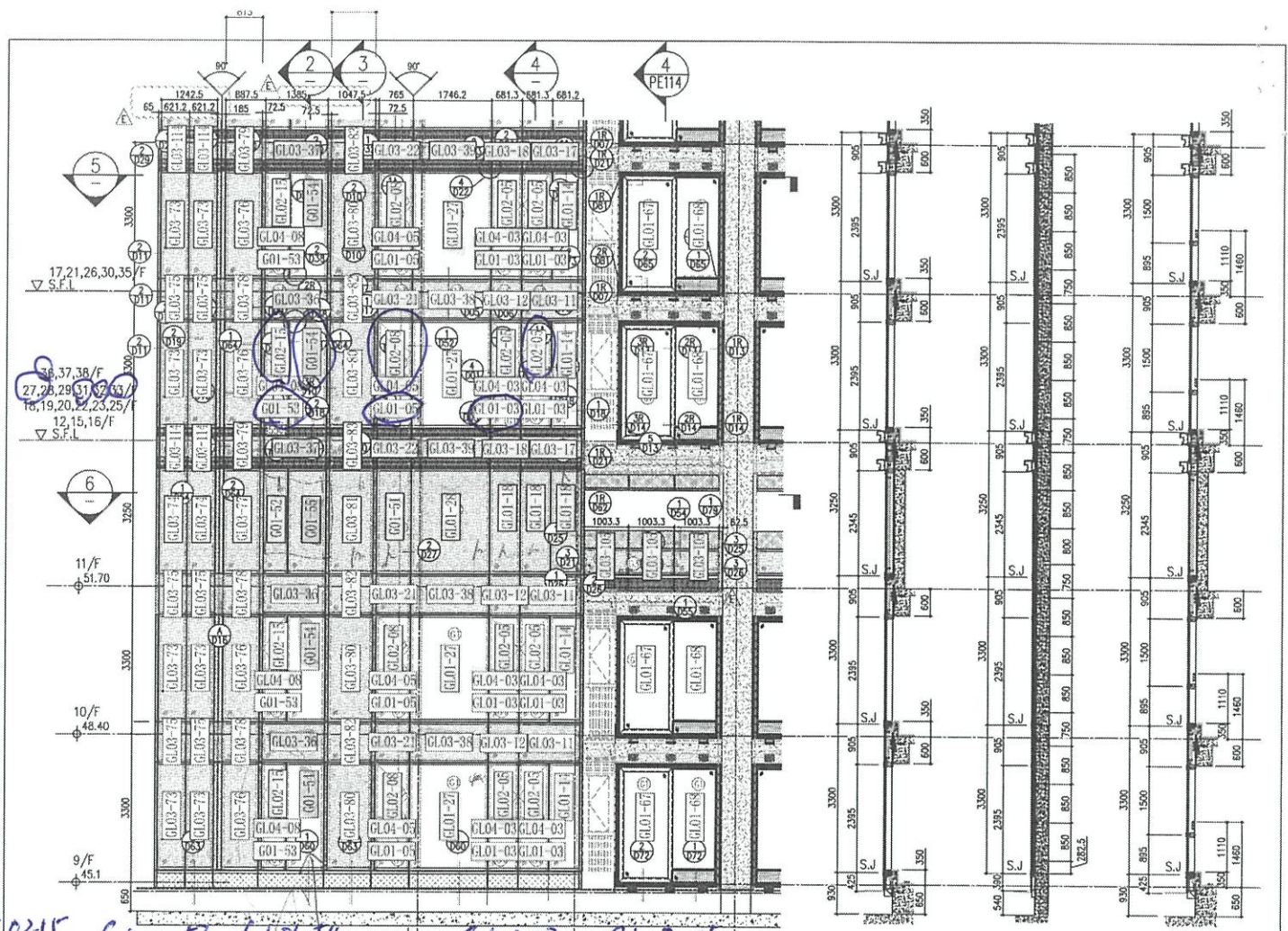

GL02-15  
27AE  
15AE

GL01-83  
36AE

GL01-84  
36AE

GL01-03  
36AE

GL02-05  
33AE  
31AE

GL02-08  
32AE

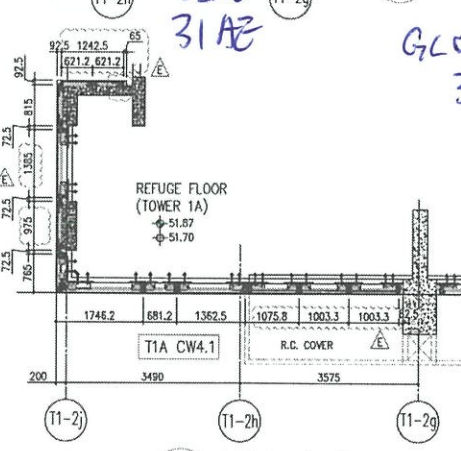
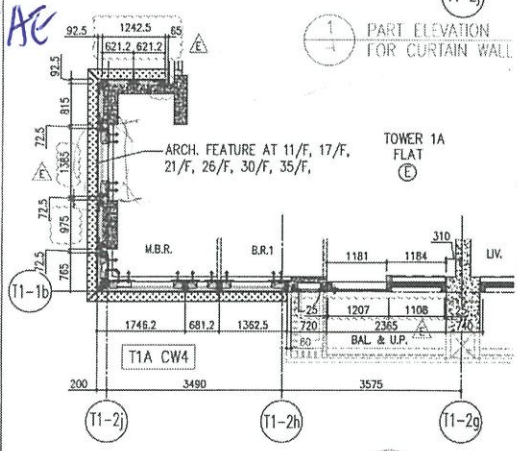

|      |        |      |         |      |         |
|------|--------|------|---------|------|---------|
| 26/F | +91.25 | 39/F | +130.85 | 52/F | +170.40 |
| 25/F | +87.95 | 38/F | +127.55 | 51/F | +167.10 |
| 23/F | +84.65 | 37/F | +124.25 | 50/F | +163.80 |
| 22/F | +81.35 | 36/F | +120.95 | 49/F | +160.50 |
| 21/F | +78.05 | 35/F | +117.65 | 48/F | +157.20 |
| 20/F | +74.75 | 33/F | +114.35 | 47/F | +153.90 |
| 19/F | +71.45 | 32/F | +111.05 | 46/F | +150.60 |
| 18/F | +68.15 | 31/F | +107.75 | 45/F | +147.30 |
| 17/F | +64.85 | 30/F | +104.45 | 43/F | +144.00 |
| 16/F | +61.55 | 29/F | +101.15 | 42/F | +140.70 |
| 15/F | +58.25 | 28/F | +97.85  | 41/F | +137.40 |
| 12/F | +54.95 | 27/F | +94.55  | 40/F | +134.10 |

|      |         |
|------|---------|
| R/F  | +203.80 |
| 62/F | +200.30 |
| 61/F | +196.80 |
| 60/F | +193.30 |
| 59/F | +190.20 |
| 58/F | +186.90 |
| 57/F | +183.60 |
| 56/F | +180.30 |
| 55/F | +177.00 |
| 53/F | +173.70 |

- LEGEND:**
- 10mm THK HEAT STRENGTHENED GLASS (OUTSIDE) +12mm AIR SPACE + 12mm THK TEMPERED GLASS
  - 10mm THK HEAT STRENGTHENED GLASS (OUTSIDE) +12mm AIR SPACE + 10mm THK TEMPERED GLASS
  - 12mm THK HEAT STRENGTHENED GLASS
  - 12mm THK CLEAR TEMPERED GLASS (INTERNAL PROTECTIVE BARRIER)
  - 10mm BLUE TINTED HEAT STRENGTHENED GLASS
  - 10mm THK CLEAR TEMPERED GLASS
  - 8mm THK CLEAR HEAT STRENGTHENED GLASS +1.52mm AIR SPACE + 8mm THK CLEAR HEAT-STRENGTHENED GLASS
  - 3mm THK ALUM. CLADDING
  - 3mm THK ALUM. BACKPAN
  - STACK JOINT

|   |  |  |  |   |          |                         |   |          |                         |   |          |                         |   |          |                         |   |          |                         |   |          |                         |   |          |                         |   |          |                         |   |          |                         |    |          |                         |    |          |                         |    |          |                         |    |          |                         |    |          |                         |    |          |                         |    |          |                         |    |          |                         |    |          |                         |    |          |                         |    |          |                         |    |          |                         |    |          |                         |    |          |                         |    |          |                         |    |          |                         |    |          |                         |    |          |                         |    |          |                         |    |          |                         |    |          |                         |    |          |                         |    |          |                         |    |          |                         |    |          |                         |    |          |                         |    |          |                         |    |          |                         |    |          |                         |    |          |                         |    |          |                         |    |          |                         |    |          |                         |    |          |                         |    |          |                         |    |          |                         |    |          |                         |    |          |                         |    |          |                         |    |          |                         |    |          |                         |    |          |                         |    |          |                         |    |          |                         |    |          |                         |    |          |                         |    |          |                         |    |          |                         |    |          |                         |    |          |                         |    |          |                         |    |          |                         |    |          |                         |    |          |                         |    |          |                         |    |          |                         |    |          |                         |    |          |                         |    |          |                         |    |          |                         |    |          |                         |    |          |                         |    |          |                         |    |          |                         |    |          |                         |    |          |                         |    |          |                         |    |          |                         |    |          |                         |    |          |                         |    |          |                         |    |          |                         |    |          |                         |    |          |                         |    |          |                         |    |          |                         |    |          |                         |    |          |                         |    |          |                         |    |          |                         |    |          |                         |    |          |                         |    |          |                         |    |          |                         |    |          |                         |    |          |                         |    |          |                         |    |          |                         |    |          |                         |    |          |                         |     |          |                         |  |  |   |
|---|--|--|--|---|----------|-------------------------|---|----------|-------------------------|---|----------|-------------------------|---|----------|-------------------------|---|----------|-------------------------|---|----------|-------------------------|---|----------|-------------------------|---|----------|-------------------------|---|----------|-------------------------|----|----------|-------------------------|----|----------|-------------------------|----|----------|-------------------------|----|----------|-------------------------|----|----------|-------------------------|----|----------|-------------------------|----|----------|-------------------------|----|----------|-------------------------|----|----------|-------------------------|----|----------|-------------------------|----|----------|-------------------------|----|----------|-------------------------|----|----------|-------------------------|----|----------|-------------------------|----|----------|-------------------------|----|----------|-------------------------|----|----------|-------------------------|----|----------|-------------------------|----|----------|-------------------------|----|----------|-------------------------|----|----------|-------------------------|----|----------|-------------------------|----|----------|-------------------------|----|----------|-------------------------|----|----------|-------------------------|----|----------|-------------------------|----|----------|-------------------------|----|----------|-------------------------|----|----------|-------------------------|----|----------|-------------------------|----|----------|-------------------------|----|----------|-------------------------|----|----------|-------------------------|----|----------|-------------------------|----|----------|-------------------------|----|----------|-------------------------|----|----------|-------------------------|----|----------|-------------------------|----|----------|-------------------------|----|----------|-------------------------|----|----------|-------------------------|----|----------|-------------------------|----|----------|-------------------------|----|----------|-------------------------|----|----------|-------------------------|----|----------|-------------------------|----|----------|-------------------------|----|----------|-------------------------|----|----------|-------------------------|----|----------|-------------------------|----|----------|-------------------------|----|----------|-------------------------|----|----------|-------------------------|----|----------|-------------------------|----|----------|-------------------------|----|----------|-------------------------|----|----------|-------------------------|----|----------|-------------------------|----|----------|-------------------------|----|----------|-------------------------|----|----------|-------------------------|----|----------|-------------------------|----|----------|-------------------------|----|----------|-------------------------|----|----------|-------------------------|----|----------|-------------------------|----|----------|-------------------------|----|----------|-------------------------|----|----------|-------------------------|----|----------|-------------------------|----|----------|-------------------------|----|----------|-------------------------|----|----------|-------------------------|----|----------|-------------------------|----|----------|-------------------------|----|----------|-------------------------|----|----------|-------------------------|----|----------|-------------------------|----|----------|-------------------------|----|----------|-------------------------|----|----------|-------------------------|----|----------|-------------------------|----|----------|-------------------------|----|----------|-------------------------|----|----------|-------------------------|----|----------|-------------------------|----|----------|-------------------------|----|----------|-------------------------|----|----------|-------------------------|----|----------|-------------------------|-----|----------|-------------------------|--|--|---|
| <p><b>DATE:</b> 22-07-21</p> <p><b>SCALE:</b> 1:50(A1)</p> <p><b>DESIGNED BY:</b></p> <p><b>CHECKED BY:</b></p> <p><b>DRAWN BY:</b></p> <p><b>DATE:</b> 22-07-21</p> <p><b>SCALE:</b> 1:50(A1)</p> <p><b>DESIGNED BY:</b></p> <p><b>CHECKED BY:</b></p> <p><b>DRAWN BY:</b></p> | <p><b>TITLE:</b></p> <p>TYPICAL FLOOR PARTIAL ELEVATION &amp; SECTION, PLAN FOR CURTAIN WALL (TOWER 1)</p> | <p><b>PROJECT:</b></p> <p>PROPOSED RESIDENTIAL DEVELOPMENT AT TOWER 1, PHASE 11, LIONS PARK, TUNG SHAN Q. N.T.</p> | <p><b>JOB NO.:</b> J-858</p> <p><b>DATE:</b> 22-07-21</p> <p><b>REVISIONS:</b></p> <table border="1"> <tr><td>1</td><td>15/06/22</td><td>REVISED AS PER COMMENTS</td></tr> <tr><td>2</td><td>06/06/22</td><td>REVISED AS PER COMMENTS</td></tr> <tr><td>3</td><td>17/02/22</td><td>REVISED AS PER COMMENTS</td></tr> <tr><td>4</td><td>20/12/21</td><td>REVISED AS PER COMMENTS</td></tr> <tr><td>5</td><td>02/12/21</td><td>REVISED AS PER COMMENTS</td></tr> <tr><td>6</td><td>02/12/21</td><td>REVISED AS PER COMMENTS</td></tr> <tr><td>7</td><td>02/12/21</td><td>REVISED AS PER COMMENTS</td></tr> <tr><td>8</td><td>02/12/21</td><td>REVISED AS PER COMMENTS</td></tr> <tr><td>9</td><td>02/12/21</td><td>REVISED AS PER COMMENTS</td></tr> <tr><td>10</td><td>02/12/21</td><td>REVISED AS PER COMMENTS</td></tr> <tr><td>11</td><td>02/12/21</td><td>REVISED AS PER COMMENTS</td></tr> <tr><td>12</td><td>02/12/21</td><td>REVISED AS PER COMMENTS</td></tr> <tr><td>13</td><td>02/12/21</td><td>REVISED AS PER COMMENTS</td></tr> <tr><td>14</td><td>02/12/21</td><td>REVISED AS PER COMMENTS</td></tr> <tr><td>15</td><td>02/12/21</td><td>REVISED AS PER COMMENTS</td></tr> <tr><td>16</td><td>02/12/21</td><td>REVISED AS PER COMMENTS</td></tr> <tr><td>17</td><td>02/12/21</td><td>REVISED AS PER COMMENTS</td></tr> <tr><td>18</td><td>02/12/21</td><td>REVISED AS PER COMMENTS</td></tr> <tr><td>19</td><td>02/12/21</td><td>REVISED AS PER COMMENTS</td></tr> <tr><td>20</td><td>02/12/21</td><td>REVISED AS PER COMMENTS</td></tr> <tr><td>21</td><td>02/12/21</td><td>REVISED AS PER COMMENTS</td></tr> <tr><td>22</td><td>02/12/21</td><td>REVISED AS PER COMMENTS</td></tr> <tr><td>23</td><td>02/12/21</td><td>REVISED AS PER COMMENTS</td></tr> <tr><td>24</td><td>02/12/21</td><td>REVISED AS PER COMMENTS</td></tr> <tr><td>25</td><td>02/12/21</td><td>REVISED AS PER COMMENTS</td></tr> <tr><td>26</td><td>02/12/21</td><td>REVISED AS PER COMMENTS</td></tr> <tr><td>27</td><td>02/12/21</td><td>REVISED AS PER COMMENTS</td></tr> <tr><td>28</td><td>02/12/21</td><td>REVISED AS PER COMMENTS</td></tr> <tr><td>29</td><td>02/12/21</td><td>REVISED AS PER COMMENTS</td></tr> <tr><td>30</td><td>02/12/21</td><td>REVISED AS PER COMMENTS</td></tr> <tr><td>31</td><td>02/12/21</td><td>REVISED AS PER COMMENTS</td></tr> <tr><td>32</td><td>02/12/21</td><td>REVISED AS PER COMMENTS</td></tr> <tr><td>33</td><td>02/12/21</td><td>REVISED AS PER COMMENTS</td></tr> <tr><td>34</td><td>02/12/21</td><td>REVISED AS PER COMMENTS</td></tr> <tr><td>35</td><td>02/12/21</td><td>REVISED AS PER COMMENTS</td></tr> <tr><td>36</td><td>02/12/21</td><td>REVISED AS PER COMMENTS</td></tr> <tr><td>37</td><td>02/12/21</td><td>REVISED AS PER COMMENTS</td></tr> <tr><td>38</td><td>02/12/21</td><td>REVISED AS PER COMMENTS</td></tr> <tr><td>39</td><td>02/12/21</td><td>REVISED AS PER COMMENTS</td></tr> <tr><td>40</td><td>02/12/21</td><td>REVISED AS PER COMMENTS</td></tr> <tr><td>41</td><td>02/12/21</td><td>REVISED AS PER COMMENTS</td></tr> <tr><td>42</td><td>02/12/21</td><td>REVISED AS PER COMMENTS</td></tr> <tr><td>43</td><td>02/12/21</td><td>REVISED AS PER COMMENTS</td></tr> <tr><td>44</td><td>02/12/21</td><td>REVISED AS PER COMMENTS</td></tr> <tr><td>45</td><td>02/12/21</td><td>REVISED AS PER COMMENTS</td></tr> <tr><td>46</td><td>02/12/21</td><td>REVISED AS PER COMMENTS</td></tr> <tr><td>47</td><td>02/12/21</td><td>REVISED AS PER COMMENTS</td></tr> <tr><td>48</td><td>02/12/21</td><td>REVISED AS PER COMMENTS</td></tr> <tr><td>49</td><td>02/12/21</td><td>REVISED AS PER COMMENTS</td></tr> <tr><td>50</td><td>02/12/21</td><td>REVISED AS PER COMMENTS</td></tr> <tr><td>51</td><td>02/12/21</td><td>REVISED AS PER COMMENTS</td></tr> <tr><td>52</td><td>02/12/21</td><td>REVISED AS PER COMMENTS</td></tr> <tr><td>53</td><td>02/12/21</td><td>REVISED AS PER COMMENTS</td></tr> <tr><td>54</td><td>02/12/21</td><td>REVISED AS PER COMMENTS</td></tr> <tr><td>55</td><td>02/12/21</td><td>REVISED AS PER COMMENTS</td></tr> <tr><td>56</td><td>02/12/21</td><td>REVISED AS PER COMMENTS</td></tr> <tr><td>57</td><td>02/12/21</td><td>REVISED AS PER COMMENTS</td></tr> <tr><td>58</td><td>02/12/21</td><td>REVISED AS PER COMMENTS</td></tr> <tr><td>59</td><td>02/12/21</td><td>REVISED AS PER COMMENTS</td></tr> <tr><td>60</td><td>02/12/21</td><td>REVISED AS PER COMMENTS</td></tr> <tr><td>61</td><td>02/12/21</td><td>REVISED AS PER COMMENTS</td></tr> <tr><td>62</td><td>02/12/21</td><td>REVISED AS PER COMMENTS</td></tr> <tr><td>63</td><td>02/12/21</td><td>REVISED AS PER COMMENTS</td></tr> <tr><td>64</td><td>02/12/21</td><td>REVISED AS PER COMMENTS</td></tr> <tr><td>65</td><td>02/12/21</td><td>REVISED AS PER COMMENTS</td></tr> <tr><td>66</td><td>02/12/21</td><td>REVISED AS PER COMMENTS</td></tr> <tr><td>67</td><td>02/12/21</td><td>REVISED AS PER COMMENTS</td></tr> <tr><td>68</td><td>02/12/21</td><td>REVISED AS PER COMMENTS</td></tr> <tr><td>69</td><td>02/12/21</td><td>REVISED AS PER COMMENTS</td></tr> <tr><td>70</td><td>02/12/21</td><td>REVISED AS PER COMMENTS</td></tr> <tr><td>71</td><td>02/12/21</td><td>REVISED AS PER COMMENTS</td></tr> <tr><td>72</td><td>02/12/21</td><td>REVISED AS PER COMMENTS</td></tr> <tr><td>73</td><td>02/12/21</td><td>REVISED AS PER COMMENTS</td></tr> <tr><td>74</td><td>02/12/21</td><td>REVISED AS PER COMMENTS</td></tr> <tr><td>75</td><td>02/12/21</td><td>REVISED AS PER COMMENTS</td></tr> <tr><td>76</td><td>02/12/21</td><td>REVISED AS PER COMMENTS</td></tr> <tr><td>77</td><td>02/12/21</td><td>REVISED AS PER COMMENTS</td></tr> <tr><td>78</td><td>02/12/21</td><td>REVISED AS PER COMMENTS</td></tr> <tr><td>79</td><td>02/12/21</td><td>REVISED AS PER COMMENTS</td></tr> <tr><td>80</td><td>02/12/21</td><td>REVISED AS PER COMMENTS</td></tr> <tr><td>81</td><td>02/12/21</td><td>REVISED AS PER COMMENTS</td></tr> <tr><td>82</td><td>02/12/21</td><td>REVISED AS PER COMMENTS</td></tr> <tr><td>83</td><td>02/12/21</td><td>REVISED AS PER COMMENTS</td></tr> <tr><td>84</td><td>02/12/21</td><td>REVISED AS PER COMMENTS</td></tr> <tr><td>85</td><td>02/12/21</td><td>REVISED AS PER COMMENTS</td></tr> <tr><td>86</td><td>02/12/21</td><td>REVISED AS PER COMMENTS</td></tr> <tr><td>87</td><td>02/12/21</td><td>REVISED AS PER COMMENTS</td></tr> <tr><td>88</td><td>02/12/21</td><td>REVISED AS PER COMMENTS</td></tr> <tr><td>89</td><td>02/12/21</td><td>REVISED AS PER COMMENTS</td></tr> <tr><td>90</td><td>02/12/21</td><td>REVISED AS PER COMMENTS</td></tr> <tr><td>91</td><td>02/12/21</td><td>REVISED AS PER COMMENTS</td></tr> <tr><td>92</td><td>02/12/21</td><td>REVISED AS PER COMMENTS</td></tr> <tr><td>93</td><td>02/12/21</td><td>REVISED AS PER COMMENTS</td></tr> <tr><td>94</td><td>02/12/21</td><td>REVISED AS PER COMMENTS</td></tr> <tr><td>95</td><td>02/12/21</td><td>REVISED AS PER COMMENTS</td></tr> <tr><td>96</td><td>02/12/21</td><td>REVISED AS PER COMMENTS</td></tr> <tr><td>97</td><td>02/12/21</td><td>REVISED AS PER COMMENTS</td></tr> <tr><td>98</td><td>02/12/21</td><td>REVISED AS PER COMMENTS</td></tr> <tr><td>99</td><td>02/12/21</td><td>REVISED AS PER COMMENTS</td></tr> <tr><td>100</td><td>02/12/21</td><td>REVISED AS PER COMMENTS</td></tr> </table> | 1 | 15/06/22 | REVISED AS PER COMMENTS | 2 | 06/06/22 | REVISED AS PER COMMENTS | 3 | 17/02/22 | REVISED AS PER COMMENTS | 4 | 20/12/21 | REVISED AS PER COMMENTS | 5 | 02/12/21 | REVISED AS PER COMMENTS | 6 | 02/12/21 | REVISED AS PER COMMENTS | 7 | 02/12/21 | REVISED AS PER COMMENTS | 8 | 02/12/21 | REVISED AS PER COMMENTS | 9 | 02/12/21 | REVISED AS PER COMMENTS | 10 | 02/12/21 | REVISED AS PER COMMENTS | 11 | 02/12/21 | REVISED AS PER COMMENTS | 12 | 02/12/21 | REVISED AS PER COMMENTS | 13 | 02/12/21 | REVISED AS PER COMMENTS | 14 | 02/12/21 | REVISED AS PER COMMENTS | 15 | 02/12/21 | REVISED AS PER COMMENTS | 16 | 02/12/21 | REVISED AS PER COMMENTS | 17 | 02/12/21 | REVISED AS PER COMMENTS | 18 | 02/12/21 | REVISED AS PER COMMENTS | 19 | 02/12/21 | REVISED AS PER COMMENTS | 20 | 02/12/21 | REVISED AS PER COMMENTS | 21 | 02/12/21 | REVISED AS PER COMMENTS | 22 | 02/12/21 | REVISED AS PER COMMENTS | 23 | 02/12/21 | REVISED AS PER COMMENTS | 24 | 02/12/21 | REVISED AS PER COMMENTS | 25 | 02/12/21 | REVISED AS PER COMMENTS | 26 | 02/12/21 | REVISED AS PER COMMENTS | 27 | 02/12/21 | REVISED AS PER COMMENTS | 28 | 02/12/21 | REVISED AS PER COMMENTS | 29 | 02/12/21 | REVISED AS PER COMMENTS | 30 | 02/12/21 | REVISED AS PER COMMENTS | 31 | 02/12/21 | REVISED AS PER COMMENTS | 32 | 02/12/21 | REVISED AS PER COMMENTS | 33 | 02/12/21 | REVISED AS PER COMMENTS | 34 | 02/12/21 | REVISED AS PER COMMENTS | 35 | 02/12/21 | REVISED AS PER COMMENTS | 36 | 02/12/21 | REVISED AS PER COMMENTS | 37 | 02/12/21 | REVISED AS PER COMMENTS | 38 | 02/12/21 | REVISED AS PER COMMENTS | 39 | 02/12/21 | REVISED AS PER COMMENTS | 40 | 02/12/21 | REVISED AS PER COMMENTS | 41 | 02/12/21 | REVISED AS PER COMMENTS | 42 | 02/12/21 | REVISED AS PER COMMENTS | 43 | 02/12/21 | REVISED AS PER COMMENTS | 44 | 02/12/21 | REVISED AS PER COMMENTS | 45 | 02/12/21 | REVISED AS PER COMMENTS | 46 | 02/12/21 | REVISED AS PER COMMENTS | 47 | 02/12/21 | REVISED AS PER COMMENTS | 48 | 02/12/21 | REVISED AS PER COMMENTS | 49 | 02/12/21 | REVISED AS PER COMMENTS | 50 | 02/12/21 | REVISED AS PER COMMENTS | 51 | 02/12/21 | REVISED AS PER COMMENTS | 52 | 02/12/21 | REVISED AS PER COMMENTS | 53 | 02/12/21 | REVISED AS PER COMMENTS | 54 | 02/12/21 | REVISED AS PER COMMENTS | 55 | 02/12/21 | REVISED AS PER COMMENTS | 56 | 02/12/21 | REVISED AS PER COMMENTS | 57 | 02/12/21 | REVISED AS PER COMMENTS | 58 | 02/12/21 | REVISED AS PER COMMENTS | 59 | 02/12/21 | REVISED AS PER COMMENTS | 60 | 02/12/21 | REVISED AS PER COMMENTS | 61 | 02/12/21 | REVISED AS PER COMMENTS | 62 | 02/12/21 | REVISED AS PER COMMENTS | 63 | 02/12/21 | REVISED AS PER COMMENTS | 64 | 02/12/21 | REVISED AS PER COMMENTS | 65 | 02/12/21 | REVISED AS PER COMMENTS | 66 | 02/12/21 | REVISED AS PER COMMENTS | 67 | 02/12/21 | REVISED AS PER COMMENTS | 68 | 02/12/21 | REVISED AS PER COMMENTS | 69 | 02/12/21 | REVISED AS PER COMMENTS | 70 | 02/12/21 | REVISED AS PER COMMENTS | 71 | 02/12/21 | REVISED AS PER COMMENTS | 72 | 02/12/21 | REVISED AS PER COMMENTS | 73 | 02/12/21 | REVISED AS PER COMMENTS | 74 | 02/12/21 | REVISED AS PER COMMENTS | 75 | 02/12/21 | REVISED AS PER COMMENTS | 76 | 02/12/21 | REVISED AS PER COMMENTS | 77 | 02/12/21 | REVISED AS PER COMMENTS | 78 | 02/12/21 | REVISED AS PER COMMENTS | 79 | 02/12/21 | REVISED AS PER COMMENTS | 80 | 02/12/21 | REVISED AS PER COMMENTS | 81 | 02/12/21 | REVISED AS PER COMMENTS | 82 | 02/12/21 | REVISED AS PER COMMENTS | 83 | 02/12/21 | REVISED AS PER COMMENTS | 84 | 02/12/21 | REVISED AS PER COMMENTS | 85 | 02/12/21 | REVISED AS PER COMMENTS | 86 | 02/12/21 | REVISED AS PER COMMENTS | 87 | 02/12/21 | REVISED AS PER COMMENTS | 88 | 02/12/21 | REVISED AS PER COMMENTS | 89 | 02/12/21 | REVISED AS PER COMMENTS | 90 | 02/12/21 | REVISED AS PER COMMENTS | 91 | 02/12/21 | REVISED AS PER COMMENTS | 92 | 02/12/21 | REVISED AS PER COMMENTS | 93 | 02/12/21 | REVISED AS PER COMMENTS | 94 | 02/12/21 | REVISED AS PER COMMENTS | 95 | 02/12/21 | REVISED AS PER COMMENTS | 96 | 02/12/21 | REVISED AS PER COMMENTS | 97 | 02/12/21 | REVISED AS PER COMMENTS | 98 | 02/12/21 | REVISED AS PER COMMENTS | 99 | 02/12/21 | REVISED AS PER COMMENTS | 100 | 02/12/21 | REVISED AS PER COMMENTS | <p><b>NOTE:</b></p> <ol style="list-style-type: none"> <li>ALL DIMENSIONS ARE IN MM.</li> <li>ALL ELEVATIONS ARE MEASURED FROM OUTSIDE OF THE FINISH FLOOR LEVEL.</li> <li>ALL DIMENSIONS TO BE CHECKED ON SITE.</li> </ol> <p><b>LEGEND:</b></p> <p> DETAIL MARK NO.</p> <p> REFER SHEET NO.</p> <p> F.F.L. — FINISHED FLOOR LEVEL.</p> <p> S.F.L. — STRUCTURAL FLOOR LEVEL.</p> <p> — REVERSED DETAIL.</p> | <p><b>PROJECT CONSULTANT:</b></p> <p><b>AECOM</b></p> <p><b>STRUCTURAL ENGINEER:</b></p> <p><b>Gammorn</b></p> <p><b>ARCHITECT:</b></p> <p>ronald lu &amp; partners<br/>Ronald Lu &amp; Partners (HK) Ltd.<br/>吳文達建築師事務所 (香港) 有限公司</p> <p><b>CLIENT:</b></p> <p>信和置業有限公司<br/>Sino Land Company Limited</p> | <p><b>DATE:</b> 22-07-21</p> <p><b>SCALE:</b> 1:50(A1)</p> <p><b>DESIGNED BY:</b></p> <p><b>CHECKED BY:</b></p> <p><b>DRAWN BY:</b></p> |
| 1   | 15/06/22   | REVISED AS PER COMMENTS  |  |   |          |                         |   |          |                         |   |          |                         |   |          |                         |   |          |                         |   |          |                         |   |          |                         |   |          |                         |   |          |                         |    |          |                         |    |          |                         |    |          |                         |    |          |                         |    |          |                         |    |          |                         |    |          |                         |    |          |                         |    |          |                         |    |          |                         |    |          |                         |    |          |                         |    |          |                         |    |          |                         |    |          |                         |    |          |                         |    |          |                         |    |          |                         |    |          |                         |    |          |                         |    |          |                         |    |          |                         |    |          |                         |    |          |                         |    |          |                         |    |          |                         |    |          |                         |    |          |                         |    |          |                         |    |          |                         |    |          |                         |    |          |                         |    |          |                         |    |          |                         |    |          |                         |    |          |                         |    |          |                         |    |          |                         |    |          |                         |    |          |                         |    |          |                         |    |          |                         |    |          |                         |    |          |                         |    |          |                         |    |          |                         |    |          |                         |    |          |                         |    |          |                         |    |          |                         |    |          |                         |    |          |                         |    |          |                         |    |          |                         |    |          |                         |    |          |                         |    |          |                         |    |          |                         |    |          |                         |    |          |                         |    |          |                         |    |          |                         |    |          |                         |    |          |                         |    |          |                         |    |          |                         |    |          |                         |    |          |                         |    |          |                         |    |          |                         |    |          |                         |    |          |                         |    |          |                         |    |          |                         |    |          |                         |    |          |                         |    |          |                         |    |          |                         |    |          |                         |    |          |                         |    |          |                         |    |          |                         |    |          |                         |    |          |                         |    |          |                         |    |          |                         |    |          |                         |    |          |                         |    |          |                         |    |          |                         |     |          |                         |  |  |   |
| 2   | 06/06/22   | REVISED AS PER COMMENTS  |  |   |          |                         |   |          |                         |   |          |                         |   |          |                         |   |          |                         |   |          |                         |   |          |                         |   |          |                         |   |          |                         |    |          |                         |    |          |                         |    |          |                         |    |          |                         |    |          |                         |    |          |                         |    |          |                         |    |          |                         |    |          |                         |    |          |                         |    |          |                         |    |          |                         |    |          |                         |    |          |                         |    |          |                         |    |          |                         |    |          |                         |    |          |                         |    |          |                         |    |          |                         |    |          |                         |    |          |                         |    |          |                         |    |          |                         |    |          |                         |    |          |                         |    |          |                         |    |          |                         |    |          |                         |    |          |                         |    |          |                         |    |          |                         |    |          |                         |    |          |                         |    |          |                         |    |          |                         |    |          |                         |    |          |                         |    |          |                         |    |          |                         |    |          |                         |    |          |                         |    |          |                         |    |          |                         |    |          |                         |    |          |                         |    |          |                         |    |          |                         |    |          |                         |    |          |                         |    |          |                         |    |          |                         |    |          |                         |    |          |                         |    |          |                         |    |          |                         |    |          |                         |    |          |                         |    |          |                         |    |          |                         |    |          |                         |    |          |                         |    |          |                         |    |          |                         |    |          |                         |    |          |                         |    |          |                         |    |          |                         |    |          |                         |    |          |                         |    |          |                         |    |          |                         |    |          |                         |    |          |                         |    |          |                         |    |          |                         |    |          |                         |    |          |                         |    |          |                         |    |          |                         |    |          |                         |    |          |                         |    |          |                         |    |          |                         |    |          |                         |    |          |                         |    |          |                         |    |          |                         |    |          |                         |    |          |                         |     |          |                         |  |  |   |
| 3   | 17/02/22   | REVISED AS PER COMMENTS  |  |   |          |                         |   |          |                         |   |          |                         |   |          |                         |   |          |                         |   |          |                         |   |          |                         |   |          |                         |   |          |                         |    |          |                         |    |          |                         |    |          |                         |    |          |                         |    |          |                         |    |          |                         |    |          |                         |    |          |                         |    |          |                         |    |          |                         |    |          |                         |    |          |                         |    |          |                         |    |          |                         |    |          |                         |    |          |                         |    |          |                         |    |          |                         |    |          |                         |    |          |                         |    |          |                         |    |          |                         |    |          |                         |    |          |                         |    |          |                         |    |          |                         |    |          |                         |    |          |                         |    |          |                         |    |          |                         |    |          |                         |    |          |                         |    |          |                         |    |          |                         |    |          |                         |    |          |                         |    |          |                         |    |          |                         |    |          |                         |    |          |                         |    |          |                         |    |          |                         |    |          |                         |    |          |                         |    |          |                         |    |          |                         |    |          |                         |    |          |                         |    |          |                         |    |          |                         |    |          |                         |    |          |                         |    |          |                         |    |          |                         |    |          |                         |    |          |                         |    |          |                         |    |          |                         |    |          |                         |    |          |                         |    |          |                         |    |          |                         |    |          |                         |    |          |                         |    |          |                         |    |          |                         |    |          |                         |    |          |                         |    |          |                         |    |          |                         |    |          |                         |    |          |                         |    |          |                         |    |          |                         |    |          |                         |    |          |                         |    |          |                         |    |          |                         |    |          |                         |    |          |                         |    |          |                         |    |          |                         |    |          |                         |    |          |                         |    |          |                         |    |          |                         |    |          |                         |    |          |                         |    |          |                         |    |          |                         |     |          |                         |  |  |   |
| 4   | 20/12/21   | REVISED AS PER COMMENTS  |  |   |          |                         |   |          |                         |   |          |                         |   |          |                         |   |          |                         |   |          |                         |   |          |                         |   |          |                         |   |          |                         |    |          |                         |    |          |                         |    |          |                         |    |          |                         |    |          |                         |    |          |                         |    |          |                         |    |          |                         |    |          |                         |    |          |                         |    |          |                         |    |          |                         |    |          |                         |    |          |                         |    |          |                         |    |          |                         |    |          |                         |    |          |                         |    |          |                         |    |          |                         |    |          |                         |    |          |                         |    |          |                         |    |          |                         |    |          |                         |    |          |                         |    |          |                         |    |          |                         |    |          |                         |    |          |                         |    |          |                         |    |          |                         |    |          |                         |    |          |                         |    |          |                         |    |          |                         |    |          |                         |    |          |                         |    |          |                         |    |          |                         |    |          |                         |    |          |                         |    |          |                         |    |          |                         |    |          |                         |    |          |                         |    |          |                         |    |          |                         |    |          |                         |    |          |                         |    |          |                         |    |          |                         |    |          |                         |    |          |                         |    |          |                         |    |          |                         |    |          |                         |    |          |                         |    |          |                         |    |          |                         |    |          |                         |    |          |                         |    |          |                         |    |          |                         |    |          |                         |    |          |                         |    |          |                         |    |          |                         |    |          |                         |    |          |                         |    |          |                         |    |          |                         |    |          |                         |    |          |                         |    |          |                         |    |          |                         |    |          |                         |    |          |                         |    |          |                         |    |          |                         |    |          |                         |    |          |                         |    |          |                         |    |          |                         |    |          |                         |    |          |                         |    |          |                         |    |          |                         |    |          |                         |    |          |                         |     |          |                         |  |  |   |
| 5   | 02/12/21   | REVISED AS PER COMMENTS  |  |   |          |                         |   |          |                         |   |          |                         |   |          |                         |   |          |                         |   |          |                         |   |          |                         |   |          |                         |   |          |                         |    |          |                         |    |          |                         |    |          |                         |    |          |                         |    |          |                         |    |          |                         |    |          |                         |    |          |                         |    |          |                         |    |          |                         |    |          |                         |    |          |                         |    |          |                         |    |          |                         |    |          |                         |    |          |                         |    |          |                         |    |          |                         |    |          |                         |    |          |                         |    |          |                         |    |          |                         |    |          |                         |    |          |                         |    |          |                         |    |          |                         |    |          |                         |    |          |                         |    |          |                         |    |          |                         |    |          |                         |    |          |                         |    |          |                         |    |          |                         |    |          |                         |    |          |                         |    |          |                         |    |          |                         |    |          |                         |    |          |                         |    |          |                         |    |          |                         |    |          |                         |    |          |                         |    |          |                         |    |          |                         |    |          |                         |    |          |                         |    |          |                         |    |          |                         |    |          |                         |    |          |                         |    |          |                         |    |          |                         |    |          |                         |    |          |                         |    |          |                         |    |          |                         |    |          |                         |    |          |                         |    |          |                         |    |          |                         |    |          |                         |    |          |                         |    |          |                         |    |          |                         |    |          |                         |    |          |                         |    |          |                         |    |          |                         |    |          |                         |    |          |                         |    |          |                         |    |          |                         |    |          |                         |    |          |                         |    |          |                         |    |          |                         |    |          |                         |    |          |                         |    |          |                         |    |          |                         |    |          |                         |    |          |                         |    |          |                         |    |          |                         |    |          |                         |    |          |                         |    |          |                         |    |          |                         |     |          |                         |  |  |   |
| 6   | 02/12/21   | REVISED AS PER COMMENTS  |  |   |          |                         |   |          |                         |   |          |                         |   |          |                         |   |          |                         |   |          |                         |   |          |                         |   |          |                         |   |          |                         |    |          |                         |    |          |                         |    |          |                         |    |          |                         |    |          |                         |    |          |                         |    |          |                         |    |          |                         |    |          |                         |    |          |                         |    |          |                         |    |          |                         |    |          |                         |    |          |                         |    |          |                         |    |          |                         |    |          |                         |    |          |                         |    |          |                         |    |          |                         |    |          |                         |    |          |                         |    |          |                         |    |          |                         |    |          |                         |    |          |                         |    |          |                         |    |          |                         |    |          |                         |    |          |                         |    |          |                         |    |          |                         |    |          |                         |    |          |                         |    |          |                         |    |          |                         |    |          |                         |    |          |                         |    |          |                         |    |          |                         |    |          |                         |    |          |                         |    |          |                         |    |          |                         |    |          |                         |    |          |                         |    |          |                         |    |          |                         |    |          |                         |    |          |                         |    |          |                         |    |          |                         |    |          |                         |    |          |                         |    |          |                         |    |          |                         |    |          |                         |    |          |                         |    |          |                         |    |          |                         |    |          |                         |    |          |                         |    |          |                         |    |          |                         |    |          |                         |    |          |                         |    |          |                         |    |          |                         |    |          |                         |    |          |                         |    |          |                         |    |          |                         |    |          |                         |    |          |                         |    |          |                         |    |          |                         |    |          |                         |    |          |                         |    |          |                         |    |          |                         |    |          |                         |    |          |                         |    |          |                         |    |          |                         |    |          |                         |    |          |                         |    |          |                         |    |          |                         |    |          |                         |    |          |                         |     |          |                         |  |  |   |
| 7   | 02/12/21   | REVISED AS PER COMMENTS  |  |   |          |                         |   |          |                         |   |          |                         |   |          |                         |   |          |                         |   |          |                         |   |          |                         |   |          |                         |   |          |                         |    |          |                         |    |          |                         |    |          |                         |    |          |                         |    |          |                         |    |          |                         |    |          |                         |    |          |                         |    |          |                         |    |          |                         |    |          |                         |    |          |                         |    |          |                         |    |          |                         |    |          |                         |    |          |                         |    |          |                         |    |          |                         |    |          |                         |    |          |                         |    |          |                         |    |          |                         |    |          |                         |    |          |                         |    |          |                         |    |          |                         |    |          |                         |    |          |                         |    |          |                         |    |          |                         |    |          |                         |    |          |                         |    |          |                         |    |          |                         |    |          |                         |    |          |                         |    |          |                         |    |          |                         |    |          |                         |    |          |                         |    |          |                         |    |          |                         |    |          |                         |    |          |                         |    |          |                         |    |          |                         |    |          |                         |    |          |                         |    |          |                         |    |          |                         |    |          |                         |    |          |                         |    |          |                         |    |          |                         |    |          |                         |    |          |                         |    |          |                         |    |          |                         |    |          |                         |    |          |                         |    |          |                         |    |          |                         |    |          |                         |    |          |                         |    |          |                         |    |          |                         |    |          |                         |    |          |                         |    |          |                         |    |          |                         |    |          |                         |    |          |                         |    |          |                         |    |          |                         |    |          |                         |    |          |                         |    |          |                         |    |          |                         |    |          |                         |    |          |                         |    |          |                         |    |          |                         |    |          |                         |    |          |                         |    |          |                         |    |          |                         |    |          |                         |    |          |                         |    |          |                         |    |          |                         |     |          |                         |  |  |   |
| 8   | 02/12/21   | REVISED AS PER COMMENTS  |  |   |          |                         |   |          |                         |   |          |                         |   |          |                         |   |          |                         |   |          |                         |   |          |                         |   |          |                         |   |          |                         |    |          |                         |    |          |                         |    |          |                         |    |          |                         |    |          |                         |    |          |                         |    |          |                         |    |          |                         |    |          |                         |    |          |                         |    |          |                         |    |          |                         |    |          |                         |    |          |                         |    |          |                         |    |          |                         |    |          |                         |    |          |                         |    |          |                         |    |          |                         |    |          |                         |    |          |                         |    |          |                         |    |          |                         |    |          |                         |    |          |                         |    |          |                         |    |          |                         |    |          |                         |    |          |                         |    |          |                         |    |          |                         |    |          |                         |    |          |                         |    |          |                         |    |          |                         |    |          |                         |    |          |                         |    |          |                         |    |          |                         |    |          |                         |    |          |                         |    |          |                         |    |          |                         |    |          |                         |    |          |                         |    |          |                         |    |          |                         |    |          |                         |    |          |                         |    |          |                         |    |          |                         |    |          |                         |    |          |                         |    |          |                         |    |          |                         |    |          |                         |    |          |                         |    |          |                         |    |          |                         |    |          |                         |    |          |                         |    |          |                         |    |          |                         |    |          |                         |    |          |                         |    |          |                         |    |          |                         |    |          |                         |    |          |                         |    |          |                         |    |          |                         |    |          |                         |    |          |                         |    |          |                         |    |          |                         |    |          |                         |    |          |                         |    |          |                         |    |          |                         |    |          |                         |    |          |                         |    |          |                         |    |          |                         |    |          |                         |    |          |                         |    |          |                         |    |          |                         |    |          |                         |    |          |                         |     |          |                         |  |  |   |
| 9   | 02/12/21   | REVISED AS PER COMMENTS  |  |   |          |                         |   |          |                         |   |          |                         |   |          |                         |   |          |                         |   |          |                         |   |          |                         |   |          |                         |   |          |                         |    |          |                         |    |          |                         |    |          |                         |    |          |                         |    |          |                         |    |          |                         |    |          |                         |    |          |                         |    |          |                         |    |          |                         |    |          |                         |    |          |                         |    |          |                         |    |          |                         |    |          |                         |    |          |                         |    |          |                         |    |          |                         |    |          |                         |    |          |                         |    |          |                         |    |          |                         |    |          |                         |    |          |                         |    |          |                         |    |          |                         |    |          |                         |    |          |                         |    |          |                         |    |          |                         |    |          |                         |    |          |                         |    |          |                         |    |          |                         |    |          |                         |    |          |                         |    |          |                         |    |          |                         |    |          |                         |    |          |                         |    |          |                         |    |          |                         |    |          |                         |    |          |                         |    |          |                         |    |          |                         |    |          |                         |    |          |                         |    |          |                         |    |          |                         |    |          |                         |    |          |                         |    |          |                         |    |          |                         |    |          |                         |    |          |                         |    |          |                         |    |          |                         |    |          |                         |    |          |                         |    |          |                         |    |          |                         |    |          |                         |    |          |                         |    |          |                         |    |          |                         |    |          |                         |    |          |                         |    |          |                         |    |          |                         |    |          |                         |    |          |                         |    |          |                         |    |          |                         |    |          |                         |    |          |                         |    |          |                         |    |          |                         |    |          |                         |    |          |                         |    |          |                         |    |          |                         |    |          |                         |    |          |                         |    |          |                         |    |          |                         |    |          |                         |    |          |                         |    |          |                         |    |          |                         |     |          |                         |  |  |   |
| 10  | 02/12/21   | REVISED AS PER COMMENTS  |  |   |          |                         |   |          |                         |   |          |                         |   |          |                         |   |          |                         |   |          |                         |   |          |                         |   |          |                         |   |          |                         |    |          |                         |    |          |                         |    |          |                         |    |          |                         |    |          |                         |    |          |                         |    |          |                         |    |          |                         |    |          |                         |    |          |                         |    |          |                         |    |          |                         |    |          |                         |    |          |                         |    |          |                         |    |          |                         |    |          |                         |    |          |                         |    |          |                         |    |          |                         |    |          |                         |    |          |                         |    |          |                         |    |          |                         |    |          |                         |    |          |                         |    |          |                         |    |          |                         |    |          |                         |    |          |                         |    |          |                         |    |          |                         |    |          |                         |    |          |                         |    |          |                         |    |          |                         |    |          |                         |    |          |                         |    |          |                         |    |          |                         |    |          |                         |    |          |                         |    |          |                         |    |          |                         |    |          |                         |    |          |                         |    |          |                         |    |          |                         |    |          |                         |    |          |                         |    |          |                         |    |          |                         |    |          |                         |    |          |                         |    |          |                         |    |          |                         |    |          |                         |    |          |                         |    |          |                         |    |          |                         |    |          |                         |    |          |                         |    |          |                         |    |          |                         |    |          |                         |    |          |                         |    |          |                         |    |          |                         |    |          |                         |    |          |                         |    |          |                         |    |          |                         |    |          |                         |    |          |                         |    |          |                         |    |          |                         |    |          |                         |    |          |                         |    |          |                         |    |          |                         |    |          |                         |    |          |                         |    |          |                         |    |          |                         |    |          |                         |    |          |                         |    |          |                         |    |          |                         |    |          |                         |    |          |                         |     |          |                         |  |  |   |
| 11  | 02/12/21   | REVISED AS PER COMMENTS  |  |   |          |                         |   |          |                         |   |          |                         |   |          |                         |   |          |                         |   |          |                         |   |          |                         |   |          |                         |   |          |                         |    |          |                         |    |          |                         |    |          |                         |    |          |                         |    |          |                         |    |          |                         |    |          |                         |    |          |                         |    |          |                         |    |          |                         |    |          |                         |    |          |                         |    |          |                         |    |          |                         |    |          |                         |    |          |                         |    |          |                         |    |          |                         |    |          |                         |    |          |                         |    |          |                         |    |          |                         |    |          |                         |    |          |                         |    |          |                         |    |          |                         |    |          |                         |    |          |                         |    |          |                         |    |          |                         |    |          |                         |    |          |                         |    |          |                         |    |          |                         |    |          |                         |    |          |                         |    |          |                         |    |          |                         |    |          |                         |    |          |                         |    |          |                         |    |          |                         |    |          |                         |    |          |                         |    |          |                         |    |          |                         |    |          |                         |    |          |                         |    |          |                         |    |          |                         |    |          |                         |    |          |                         |    |          |                         |    |          |                         |    |          |                         |    |          |                         |    |          |                         |    |          |                         |    |          |                         |    |          |                         |    |          |                         |    |          |                         |    |          |                         |    |          |                         |    |          |                         |    |          |                         |    |          |                         |    |          |                         |    |          |                         |    |          |                         |    |          |                         |    |          |                         |    |          |                         |    |          |                         |    |          |                         |    |          |                         |    |          |                         |    |          |                         |    |          |                         |    |          |                         |    |          |                         |    |          |                         |    |          |                         |    |          |                         |    |          |                         |    |          |                         |    |          |                         |    |          |                         |    |          |                         |    |          |                         |     |          |                         |  |  |   |
| 12  | 02/12/21   | REVISED AS PER COMMENTS  |  |   |          |                         |   |          |                         |   |          |                         |   |          |                         |   |          |                         |   |          |                         |   |          |                         |   |          |                         |   |          |                         |    |          |                         |    |          |                         |    |          |                         |    |          |                         |    |          |                         |    |          |                         |    |          |                         |    |          |                         |    |          |                         |    |          |                         |    |          |                         |    |          |                         |    |          |                         |    |          |                         |    |          |                         |    |          |                         |    |          |                         |    |          |                         |    |          |                         |    |          |                         |    |          |                         |    |          |                         |    |          |                         |    |          |                         |    |          |                         |    |          |                         |    |          |                         |    |          |                         |    |          |                         |    |          |                         |    |          |                         |    |          |                         |    |          |                         |    |          |                         |    |          |                         |    |          |                         |    |          |                         |    |          |                         |    |          |                         |    |          |                         |    |          |                         |    |          |                         |    |          |                         |    |          |                         |    |          |                         |    |          |                         |    |          |                         |    |          |                         |    |          |                         |    |          |                         |    |          |                         |    |          |                         |    |          |                         |    |          |                         |    |          |                         |    |          |                         |    |          |                         |    |          |                         |    |          |                         |    |          |                         |    |          |                         |    |          |                         |    |          |                         |    |          |                         |    |          |                         |    |          |                         |    |          |                         |    |          |                         |    |          |                         |    |          |                         |    |          |                         |    |          |                         |    |          |                         |    |          |                         |    |          |                         |    |          |                         |    |          |                         |    |          |                         |    |          |                         |    |          |                         |    |          |                         |    |          |                         |    |          |                         |    |          |                         |    |          |                         |    |          |                         |    |          |                         |    |          |                         |    |          |                         |    |          |                         |     |          |                         |  |  |   |
| 13  | 02/12/21   | REVISED AS PER COMMENTS  |  |   |          |                         |   |          |                         |   |          |                         |   |          |                         |   |          |                         |   |          |                         |   |          |                         |   |          |                         |   |          |                         |    |          |                         |    |          |                         |    |          |                         |    |          |                         |    |          |                         |    |          |                         |    |          |                         |    |          |                         |    |          |                         |    |          |                         |    |          |                         |    |          |                         |    |          |                         |    |          |                         |    |          |                         |    |          |                         |    |          |                         |    |          |                         |    |          |                         |    |          |                         |    |          |                         |    |          |                         |    |          |                         |    |          |                         |    |          |                         |    |          |                         |    |          |                         |    |          |                         |    |          |                         |    |          |                         |    |          |                         |    |          |                         |    |          |                         |    |          |                         |    |          |                         |    |          |                         |    |          |                         |    |          |                         |    |          |                         |    |          |                         |    |          |                         |    |          |                         |    |          |                         |    |          |                         |    |          |                         |    |          |                         |    |          |                         |    |          |                         |    |          |                         |    |          |                         |    |          |                         |    |          |                         |    |          |                         |    |          |                         |    |          |                         |    |          |                         |    |          |                         |    |          |                         |    |          |                         |    |          |                         |    |          |                         |    |          |                         |    |          |                         |    |          |                         |    |          |                         |    |          |                         |    |          |                         |    |          |                         |    |          |                         |    |          |                         |    |          |                         |    |          |                         |    |          |                         |    |          |                         |    |          |                         |    |          |                         |    |          |                         |    |          |                         |    |          |                         |    |          |                         |    |          |                         |    |          |                         |    |          |                         |    |          |                         |    |          |                         |    |          |                         |    |          |                         |    |          |                         |    |          |                         |    |          |                         |     |          |                         |  |  |   |
| 14  | 02/12/21   | REVISED AS PER COMMENTS  |  |   |          |                         |   |          |                         |   |          |                         |   |          |                         |   |          |                         |   |          |                         |   |          |                         |   |          |                         |   |          |                         |    |          |                         |    |          |                         |    |          |                         |    |          |                         |    |          |                         |    |          |                         |    |          |                         |    |          |                         |    |          |                         |    |          |                         |    |          |                         |    |          |                         |    |          |                         |    |          |                         |    |          |                         |    |          |                         |    |          |                         |    |          |                         |    |          |                         |    |          |                         |    |          |                         |    |          |                         |    |          |                         |    |          |                         |    |          |                         |    |          |                         |    |          |                         |    |          |                         |    |          |                         |    |          |                         |    |          |                         |    |          |                         |    |          |                         |    |          |                         |    |          |                         |    |          |                         |    |          |                         |    |          |                         |    |          |                         |    |          |                         |    |          |                         |    |          |                         |    |          |                         |    |          |                         |    |          |                         |    |          |                         |    |          |                         |    |          |                         |    |          |                         |    |          |                         |    |          |                         |    |          |                         |    |          |                         |    |          |                         |    |          |                         |    |          |                         |    |          |                         |    |          |                         |    |          |                         |    |          |                         |    |          |                         |    |          |                         |    |          |                         |    |          |                         |    |          |                         |    |          |                         |    |          |                         |    |          |                         |    |          |                         |    |          |                         |    |          |                         |    |          |                         |    |          |                         |    |          |                         |    |          |                         |    |          |                         |    |          |                         |    |          |                         |    |          |                         |    |          |                         |    |          |                         |    |          |                         |    |          |                         |    |          |                         |    |          |                         |    |          |                         |    |          |                         |    |          |                         |    |          |                         |    |          |                         |     |          |                         |  |  |   |
| 15  | 02/12/21   | REVISED AS PER COMMENTS  |  |   |          |                         |   |          |                         |   |          |                         |   |          |                         |   |          |                         |   |          |                         |   |          |                         |   |          |                         |   |          |                         |    |          |                         |    |          |                         |    |          |                         |    |          |                         |    |          |                         |    |          |                         |    |          |                         |    |          |                         |    |          |                         |    |          |                         |    |          |                         |    |          |                         |    |          |                         |    |          |                         |    |          |                         |    |          |                         |    |          |                         |    |          |                         |    |          |                         |    |          |                         |    |          |                         |    |          |                         |    |          |                         |    |          |                         |    |          |                         |    |          |                         |    |          |                         |    |          |                         |    |          |                         |    |          |                         |    |          |                         |    |          |                         |    |          |                         |    |          |                         |    |          |                         |    |          |                         |    |          |                         |    |          |                         |    |          |                         |    |          |                         |    |          |                         |    |          |                         |    |          |                         |    |          |                         |    |          |                         |    |          |                         |    |          |                         |    |          |                         |    |          |                         |    |          |                         |    |          |                         |    |          |                         |    |          |                         |    |          |                         |    |          |                         |    |          |                         |    |          |                         |    |          |                         |    |          |                         |    |          |                         |    |          |                         |    |          |                         |    |          |                         |    |          |                         |    |          |                         |    |          |                         |    |          |                         |    |          |                         |    |          |                         |    |          |                         |    |          |                         |    |          |                         |    |          |                         |    |          |                         |    |          |                         |    |          |                         |    |          |                         |    |          |                         |    |          |                         |    |          |                         |    |          |                         |    |          |                         |    |          |                         |    |          |                         |    |          |                         |    |          |                         |    |          |                         |    |          |                         |    |          |                         |    |          |                         |     |          |                         |  |  |   |
| 16  | 02/12/21   | REVISED AS PER COMMENTS  |  |   |          |                         |   |          |                         |   |          |                         |   |          |                         |   |          |                         |   |          |                         |   |          |                         |   |          |                         |   |          |                         |    |          |                         |    |          |                         |    |          |                         |    |          |                         |    |          |                         |    |          |                         |    |          |                         |    |          |                         |    |          |                         |    |          |                         |    |          |                         |    |          |                         |    |          |                         |    |          |                         |    |          |                         |    |          |                         |    |          |                         |    |          |                         |    |          |                         |    |          |                         |    |          |                         |    |          |                         |    |          |                         |    |          |                         |    |          |                         |    |          |                         |    |          |                         |    |          |                         |    |          |                         |    |          |                         |    |          |                         |    |          |                         |    |          |                         |    |          |                         |    |          |                         |    |          |                         |    |          |                         |    |          |                         |    |          |                         |    |          |                         |    |          |                         |    |          |                         |    |          |                         |    |          |                         |    |          |                         |    |          |                         |    |          |                         |    |          |                         |    |          |                         |    |          |                         |    |          |                         |    |          |                         |    |          |                         |    |          |                         |    |          |                         |    |          |                         |    |          |                         |    |          |                         |    |          |                         |    |          |                         |    |          |                         |    |          |                         |    |          |                         |    |          |                         |    |          |                         |    |          |                         |    |          |                         |    |          |                         |    |          |                         |    |          |                         |    |          |                         |    |          |                         |    |          |                         |    |          |                         |    |          |                         |    |          |                         |    |          |                         |    |          |                         |    |          |                         |    |          |                         |    |          |                         |    |          |                         |    |          |                         |    |          |                         |    |          |                         |    |          |                         |    |          |                         |    |          |                         |    |          |                         |    |          |                         |     |          |                         |  |  |   |
| 17  | 02/12/21   | REVISED AS PER COMMENTS  |  |   |          |                         |   |          |                         |   |          |                         |   |          |                         |   |          |                         |   |          |                         |   |          |                         |   |          |                         |   |          |                         |    |          |                         |    |          |                         |    |          |                         |    |          |                         |    |          |                         |    |          |                         |    |          |                         |    |          |                         |    |          |                         |    |          |                         |    |          |                         |    |          |                         |    |          |                         |    |          |                         |    |          |                         |    |          |                         |    |          |                         |    |          |                         |    |          |                         |    |          |                         |    |          |                         |    |          |                         |    |          |                         |    |          |                         |    |          |                         |    |          |                         |    |          |                         |    |          |                         |    |          |                         |    |          |                         |    |          |                         |    |          |                         |    |          |                         |    |          |                         |    |          |                         |    |          |                         |    |          |                         |    |          |                         |    |          |                         |    |          |                         |    |          |                         |    |          |                         |    |          |                         |    |          |                         |    |          |                         |    |          |                         |    |          |                         |    |          |                         |    |          |                         |    |          |                         |    |          |                         |    |          |                         |    |          |                         |    |          |                         |    |          |                         |    |          |                         |    |          |                         |    |          |                         |    |          |                         |    |          |                         |    |          |                         |    |          |                         |    |          |                         |    |          |                         |    |          |                         |    |          |                         |    |          |                         |    |          |                         |    |          |                         |    |          |                         |    |          |                         |    |          |                         |    |          |                         |    |          |                         |    |          |                         |    |          |                         |    |          |                         |    |          |                         |    |          |                         |    |          |                         |    |          |                         |    |          |                         |    |          |                         |    |          |                         |    |          |                         |    |          |                         |    |          |                         |    |          |                         |    |          |                         |    |          |                         |     |          |                         |  |  |   |
| 18  | 02/12/21   | REVISED AS PER COMMENTS  |  |   |          |                         |   |          |                         |   |          |                         |   |          |                         |   |          |                         |   |          |                         |   |          |                         |   |          |                         |   |          |                         |    |          |                         |    |          |                         |    |          |                         |    |          |                         |    |          |                         |    |          |                         |    |          |                         |    |          |                         |    |          |                         |    |          |                         |    |          |                         |    |          |                         |    |          |                         |    |          |                         |    |          |                         |    |          |                         |    |          |                         |    |          |                         |    |          |                         |    |          |                         |    |          |                         |    |          |                         |    |          |                         |    |          |                         |    |          |                         |    |          |                         |    |          |                         |    |          |                         |    |          |                         |    |          |                         |    |          |                         |    |          |                         |    |          |                         |    |          |                         |    |          |                         |    |          |                         |    |          |                         |    |          |                         |    |          |                         |    |          |                         |    |          |                         |    |          |                         |    |          |                         |    |          |                         |    |          |                         |    |          |                         |    |          |                         |    |          |                         |    |          |                         |    |          |                         |    |          |                         |    |          |                         |    |          |                         |    |          |                         |    |          |                         |    |          |                         |    |          |                         |    |          |                         |    |          |                         |    |          |                         |    |          |                         |    |          |                         |    |          |                         |    |          |                         |    |          |                         |    |          |                         |    |          |                         |    |          |                         |    |          |                         |    |          |                         |    |          |                         |    |          |                         |    |          |                         |    |          |                         |    |          |                         |    |          |                         |    |          |                         |    |          |                         |    |          |                         |    |          |                         |    |          |                         |    |          |                         |    |          |                         |    |          |                         |    |          |                         |    |          |                         |    |          |                         |    |          |                         |    |          |                         |    |          |                         |     |          |                         |  |  |   |
| 19  | 02/12/21   | REVISED AS PER COMMENTS  |  |   |          |                         |   |          |                         |   |          |                         |   |          |                         |   |          |                         |   |          |                         |   |          |                         |   |          |                         |   |          |                         |    |          |                         |    |          |                         |    |          |                         |    |          |                         |    |          |                         |    |          |                         |    |          |                         |    |          |                         |    |          |                         |    |          |                         |    |          |                         |    |          |                         |    |          |                         |    |          |                         |    |          |                         |    |          |                         |    |          |                         |    |          |                         |    |          |                         |    |          |                         |    |          |                         |    |          |                         |    |          |                         |    |          |                         |    |          |                         |    |          |                         |    |          |                         |    |          |                         |    |          |                         |    |          |                         |    |          |                         |    |          |                         |    |          |                         |    |          |                         |    |          |                         |    |          |                         |    |          |                         |    |          |                         |    |          |                         |    |          |                         |    |          |                         |    |          |                         |    |          |                         |    |          |                         |    |          |                         |    |          |                         |    |          |                         |    |          |                         |    |          |                         |    |          |                         |    |          |                         |    |          |                         |    |          |                         |    |          |                         |    |          |                         |    |          |                         |    |          |                         |    |          |                         |    |          |                         |    |          |                         |    |          |                         |    |          |                         |    |          |                         |    |          |                         |    |          |                         |    |          |                         |    |          |                         |    |          |                         |    |          |                         |    |          |                         |    |          |                         |    |          |                         |    |          |                         |    |          |                         |    |          |                         |    |          |                         |    |          |                         |    |          |                         |    |          |                         |    |          |                         |    |          |                         |    |          |                         |    |          |                         |    |          |                         |    |          |                         |    |          |                         |    |          |                         |    |          |                         |    |          |                         |    |          |                         |     |          |                         |  |  |   |
| 20  | 02/12/21   | REVISED AS PER COMMENTS  |  |   |          |                         |   |          |                         |   |          |                         |   |          |                         |   |          |                         |   |          |                         |   |          |                         |   |          |                         |   |          |                         |    |          |                         |    |          |                         |    |          |                         |    |          |                         |    |          |                         |    |          |                         |    |          |                         |    |          |                         |    |          |                         |    |          |                         |    |          |                         |    |          |                         |    |          |                         |    |          |                         |    |          |                         |    |          |                         |    |          |                         |    |          |                         |    |          |                         |    |          |                         |    |          |                         |    |          |                         |    |          |                         |    |          |                         |    |          |                         |    |          |                         |    |          |                         |    |          |                         |    |          |                         |    |          |                         |    |          |                         |    |          |                         |    |          |                         |    |          |                         |    |          |                         |    |          |                         |    |          |                         |    |          |                         |    |          |                         |    |          |                         |    |          |                         |    |          |                         |    |          |                         |    |          |                         |    |          |                         |    |          |                         |    |          |                         |    |          |                         |    |          |                         |    |          |                         |    |          |                         |    |          |                         |    |          |                         |    |          |                         |    |          |                         |    |          |                         |    |          |                         |    |          |                         |    |          |                         |    |          |                         |    |          |                         |    |          |                         |    |          |                         |    |          |                         |    |          |                         |    |          |                         |    |          |                         |    |          |                         |    |          |                         |    |          |                         |    |          |                         |    |          |                         |    |          |                         |    |          |                         |    |          |                         |    |          |                         |    |          |                         |    |          |                         |    |          |                         |    |          |                         |    |          |                         |    |          |                         |    |          |                         |    |          |                         |    |          |                         |    |          |                         |    |          |                         |    |          |                         |    |          |                         |    |          |                         |     |          |                         |  |  |   |
| 21  | 02/12/21   | REVISED AS PER COMMENTS  |  |   |          |                         |   |          |                         |   |          |                         |   |          |                         |   |          |                         |   |          |                         |   |          |                         |   |          |                         |   |          |                         |    |          |                         |    |          |                         |    |          |                         |    |          |                         |    |          |                         |    |          |                         |    |          |                         |    |          |                         |    |          |                         |    |          |                         |    |          |                         |    |          |                         |    |          |                         |    |          |                         |    |          |                         |    |          |                         |    |          |                         |    |          |                         |    |          |                         |    |          |                         |    |          |                         |    |          |                         |    |          |                         |    |          |                         |    |          |                         |    |          |                         |    |          |                         |    |          |                         |    |          |                         |    |          |                         |    |          |                         |    |          |                         |    |          |                         |    |          |                         |    |          |                         |    |          |                         |    |          |                         |    |          |                         |    |          |                         |    |          |                         |    |          |                         |    |          |                         |    |          |                         |    |          |                         |    |          |                         |    |          |                         |    |          |                         |    |          |                         |    |          |                         |    |          |                         |    |          |                         |    |          |                         |    |          |                         |    |          |                         |    |          |                         |    |          |                         |    |          |                         |    |          |                         |    |          |                         |    |          |                         |    |          |                         |    |          |                         |    |          |                         |    |          |                         |    |          |                         |    |          |                         |    |          |                         |    |          |                         |    |          |                         |    |          |                         |    |          |                         |    |          |                         |    |          |                         |    |          |                         |    |          |                         |    |          |                         |    |          |                         |    |          |                         |    |          |                         |    |          |                         |    |          |                         |    |          |                         |    |          |                         |    |          |                         |    |          |                         |    |          |                         |    |          |                         |    |          |                         |    |          |                         |    |          |                         |     |          |                         |  |  |   |
| 22  | 02/12/21   | REVISED AS PER COMMENTS  |  |   |          |                         |   |          |                         |   |          |                         |   |          |                         |   |          |                         |   |          |                         |   |          |                         |   |          |                         |   |          |                         |    |          |                         |    |          |                         |    |          |                         |    |          |                         |    |          |                         |    |          |                         |    |          |                         |    |          |                         |    |          |                         |    |          |                         |    |          |                         |    |          |                         |    |          |                         |    |          |                         |    |          |                         |    |          |                         |    |          |                         |    |          |                         |    |          |                         |    |          |                         |    |          |                         |    |          |                         |    |          |                         |    |          |                         |    |          |                         |    |          |                         |    |          |                         |    |          |                         |    |          |                         |    |          |                         |    |          |                         |    |          |                         |    |          |                         |    |          |                         |    |          |                         |    |          |                         |    |          |                         |    |          |                         |    |          |                         |    |          |                         |    |          |                         |    |          |                         |    |          |                         |    |          |                         |    |          |                         |    |          |                         |    |          |                         |    |          |                         |    |          |                         |    |          |                         |    |          |                         |    |          |                         |    |          |                         |    |          |                         |    |          |                         |    |          |                         |    |          |                         |    |          |                         |    |          |                         |    |          |                         |    |          |                         |    |          |                         |    |          |                         |    |          |                         |    |          |                         |    |          |                         |    |          |                         |    |          |                         |    |          |                         |    |          |                         |    |          |                         |    |          |                         |    |          |                         |    |          |                         |    |          |                         |    |          |                         |    |          |                         |    |          |                         |    |          |                         |    |          |                         |    |          |                         |    |          |                         |    |          |                         |    |          |                         |    |          |                         |    |          |                         |    |          |                         |    |          |                         |    |          |                         |    |          |                         |     |          |                         |  |  |   |
| 23  | 02/12/21   | REVISED AS PER COMMENTS  |  |   |          |                         |   |          |                         |   |          |                         |   |          |                         |   |          |                         |   |          |                         |   |          |                         |   |          |                         |   |          |                         |    |          |                         |    |          |                         |    |          |                         |    |          |                         |    |          |                         |    |          |                         |    |          |                         |    |          |                         |    |          |                         |    |          |                         |    |          |                         |    |          |                         |    |          |                         |    |          |                         |    |          |                         |    |          |                         |    |          |                         |    |          |                         |    |          |                         |    |          |                         |    |          |                         |    |          |                         |    |          |                         |    |          |                         |    |          |                         |    |          |                         |    |          |                         |    |          |                         |    |          |                         |    |          |                         |    |          |                         |    |          |                         |    |          |                         |    |          |                         |    |          |                         |    |          |                         |    |          |                         |    |          |                         |    |          |                         |    |          |                         |    |          |                         |    |          |                         |    |          |                         |    |          |                         |    |          |                         |    |          |                         |    |          |                         |    |          |                         |    |          |                         |    |          |                         |    |          |                         |    |          |                         |    |          |                         |    |          |                         |    |          |                         |    |          |                         |    |          |                         |    |          |                         |    |          |                         |    |          |                         |    |          |                         |    |          |                         |    |          |                         |    |          |                         |    |          |                         |    |          |                         |    |          |                         |    |          |                         |    |          |                         |    |          |                         |    |          |                         |    |          |                         |    |          |                         |    |          |                         |    |          |                         |    |          |                         |    |          |                         |    |          |                         |    |          |                         |    |          |                         |    |          |                         |    |          |                         |    |          |                         |    |          |                         |    |          |                         |    |          |                         |    |          |                         |    |          |                         |    |          |                         |    |          |                         |     |          |                         |  |  |   |
| 24  | 02/12/21   | REVISED AS PER COMMENTS  |  |   |          |                         |   |          |                         |   |          |                         |   |          |                         |   |          |                         |   |          |                         |   |          |                         |   |          |                         |   |          |                         |    |          |                         |    |          |                         |    |          |                         |    |          |                         |    |          |                         |    |          |                         |    |          |                         |    |          |                         |    |          |                         |    |          |                         |    |          |                         |    |          |                         |    |          |                         |    |          |                         |    |          |                         |    |          |                         |    |          |                         |    |          |                         |    |          |                         |    |          |                         |    |          |                         |    |          |                         |    |          |                         |    |          |                         |    |          |                         |    |          |                         |    |          |                         |    |          |                         |    |          |                         |    |          |                         |    |          |                         |    |          |                         |    |          |                         |    |          |                         |    |          |                         |    |          |                         |    |          |                         |    |          |                         |    |          |                         |    |          |                         |    |          |                         |    |          |                         |    |          |                         |    |          |                         |    |          |                         |    |          |                         |    |          |                         |    |          |                         |    |          |                         |    |          |                         |    |          |                         |    |          |                         |    |          |                         |    |          |                         |    |          |                         |    |          |                         |    |          |                         |    |          |                         |    |          |                         |    |          |                         |    |          |                         |    |          |                         |    |          |                         |    |          |                         |    |          |                         |    |          |                         |    |          |                         |    |          |                         |    |          |                         |    |          |                         |    |          |                         |    |          |                         |    |          |                         |    |          |                         |    |          |                         |    |          |                         |    |          |                         |    |          |                         |    |          |                         |    |          |                         |    |          |                         |    |          |                         |    |          |                         |    |          |                         |    |          |                         |    |          |                         |    |          |                         |    |          |                         |    |          |                         |    |          |                         |     |          |                         |  |  |   |
| 25  | 02/12/21   | REVISED AS PER COMMENTS  |  |   |          |                         |   |          |                         |   |          |                         |   |          |                         |   |          |                         |   |          |                         |   |          |                         |   |          |                         |   |          |                         |    |          |                         |    |          |                         |    |          |                         |    |          |                         |    |          |                         |    |          |                         |    |          |                         |    |          |                         |    |          |                         |    |          |                         |    |          |                         |    |          |                         |    |          |                         |    |          |                         |    |          |                         |    |          |                         |    |          |                         |    |          |                         |    |          |                         |    |          |                         |    |          |                         |    |          |                         |    |          |                         |    |          |                         |    |          |                         |    |          |                         |    |          |                         |    |          |                         |    |          |                         |    |          |                         |    |          |                         |    |          |                         |    |          |                         |    |          |                         |    |          |                         |    |          |                         |    |          |                         |    |          |                         |    |          |                         |    |          |                         |    |          |                         |    |          |                         |    |          |                         |    |          |                         |    |          |                         |    |          |                         |    |          |                         |    |          |                         |    |          |                         |    |          |                         |    |          |                         |    |          |                         |    |          |                         |    |          |                         |    |          |                         |    |          |                         |    |          |                         |    |          |                         |    |          |                         |    |          |                         |    |          |                         |    |          |                         |    |          |                         |    |          |                         |    |          |                         |    |          |                         |    |          |                         |    |          |                         |    |          |                         |    |          |                         |    |          |                         |    |          |                         |    |          |                         |    |          |                         |    |          |                         |    |          |                         |    |          |                         |    |          |                         |    |          |                         |    |          |                         |    |          |                         |    |          |                         |    |          |                         |    |          |                         |    |          |                         |    |          |                         |    |          |                         |    |          |                         |    |          |                         |    |          |                         |     |          |                         |  |  |   |
| 26  | 02/12/21   | REVISED AS PER COMMENTS  |  |   |          |                         |   |          |                         |   |          |                         |   |          |                         |   |          |                         |   |          |                         |   |          |                         |   |          |                         |   |          |                         |    |          |                         |    |          |                         |    |          |                         |    |          |                         |    |          |                         |    |          |                         |    |          |                         |    |          |                         |    |          |                         |    |          |                         |    |          |                         |    |          |                         |    |          |                         |    |          |                         |    |          |                         |    |          |                         |    |          |                         |    |          |                         |    |          |                         |    |          |                         |    |          |                         |    |          |                         |    |          |                         |    |          |                         |    |          |                         |    |          |                         |    |          |                         |    |          |                         |    |          |                         |    |          |                         |    |          |                         |    |          |                         |    |          |                         |    |          |                         |    |          |                         |    |          |                         |    |          |                         |    |          |                         |    |          |                         |    |          |                         |    |          |                         |    |          |                         |    |          |                         |    |          |                         |    |          |                         |    |          |                         |    |          |                         |    |          |                         |    |          |                         |    |          |                         |    |          |                         |    |          |                         |    |          |                         |    |          |                         |    |          |                         |    |          |                         |    |          |                         |    |          |                         |    |          |                         |    |          |                         |    |          |                         |    |          |                         |    |          |                         |    |          |                         |    |          |                         |    |          |                         |    |          |                         |    |          |                         |    |          |                         |    |          |                         |    |          |                         |    |          |                         |    |          |                         |    |          |                         |    |          |                         |    |          |                         |    |          |                         |    |          |                         |    |          |                         |    |          |                         |    |          |                         |    |          |                         |    |          |                         |    |          |                         |    |          |                         |    |          |                         |    |          |                         |    |          |                         |    |          |                         |    |          |                         |     |          |                         |  |  |   |
| 27  | 02/12/21   | REVISED AS PER COMMENTS  |  |   |          |                         |   |          |                         |   |          |                         |   |          |                         |   |          |                         |   |          |                         |   |          |                         |   |          |                         |   |          |                         |    |          |                         |    |          |                         |    |          |                         |    |          |                         |    |          |                         |    |          |                         |    |          |                         |    |          |                         |    |          |                         |    |          |                         |    |          |                         |    |          |                         |    |          |                         |    |          |                         |    |          |                         |    |          |                         |    |          |                         |    |          |                         |    |          |                         |    |          |                         |    |          |                         |    |          |                         |    |          |                         |    |          |                         |    |          |                         |    |          |                         |    |          |                         |    |          |                         |    |          |                         |    |          |                         |    |          |                         |    |          |                         |    |          |                         |    |          |                         |    |          |                         |    |          |                         |    |          |                         |    |          |                         |    |          |                         |    |          |                         |    |          |                         |    |          |                         |    |          |                         |    |          |                         |    |          |                         |    |          |                         |    |          |                         |    |          |                         |    |          |                         |    |          |                         |    |          |                         |    |          |                         |    |          |                         |    |          |                         |    |          |                         |    |          |                         |    |          |                         |    |          |                         |    |          |                         |    |          |                         |    |          |                         |    |          |                         |    |          |                         |    |          |                         |    |          |                         |    |          |                         |    |          |                         |    |          |                         |    |          |                         |    |          |                         |    |          |                         |    |          |                         |    |          |                         |    |          |                         |    |          |                         |    |          |                         |    |          |                         |    |          |                         |    |          |                         |    |          |                         |    |          |                         |    |          |                         |    |          |                         |    |          |                         |    |          |                         |    |          |                         |    |          |                         |    |          |                         |    |          |                         |    |          |                         |     |          |                         |  |  |   |
| 28  | 02/12/21   | REVISED AS PER COMMENTS  |  |   |          |                         |   |          |                         |   |          |                         |   |          |                         |   |          |                         |   |          |                         |   |          |                         |   |          |                         |   |          |                         |    |          |                         |    |          |                         |    |          |                         |    |          |                         |    |          |                         |    |          |                         |    |          |                         |    |          |                         |    |          |                         |    |          |                         |    |          |                         |    |          |                         |    |          |                         |    |          |                         |    |          |                         |    |          |                         |    |          |                         |    |          |                         |    |          |                         |    |          |                         |    |          |                         |    |          |                         |    |          |                         |    |          |                         |    |          |                         |    |          |                         |    |          |                         |    |          |                         |    |          |                         |    |          |                         |    |          |                         |    |          |                         |    |          |                         |    |          |                         |    |          |                         |    |          |                         |    |          |                         |    |          |                         |    |          |                         |    |          |                         |    |          |                         |    |          |                         |    |          |                         |    |          |                         |    |          |                         |    |          |                         |    |          |                         |    |          |                         |    |          |                         |    |          |                         |    |          |                         |    |          |                         |    |          |                         |    |          |                         |    |          |                         |    |          |                         |    |          |                         |    |          |                         |    |          |                         |    |          |                         |    |          |                         |    |          |                         |    |          |                         |    |          |                         |    |          |                         |    |          |                         |    |          |                         |    |          |                         |    |          |                         |    |          |                         |    |          |                         |    |          |                         |    |          |                         |    |          |                         |    |          |                         |    |          |                         |    |          |                         |    |          |                         |    |          |                         |    |          |                         |    |          |                         |    |          |                         |    |          |                         |    |          |                         |    |          |                         |    |          |                         |    |          |                         |    |          |                         |    |          |                         |    |          |                         |     |          |                         |  |  |   |
| 29  | 02/12/21   | REVISED AS PER COMMENTS  |  |   |          |                         |   |          |                         |   |          |                         |   |          |                         |   |          |                         |   |          |                         |   |          |                         |   |          |                         |   |          |                         |    |          |                         |    |          |                         |    |          |                         |    |          |                         |    |          |                         |    |          |                         |    |          |                         |    |          |                         |    |          |                         |    |          |                         |    |          |                         |    |          |                         |    |          |                         |    |          |                         |    |          |                         |    |          |                         |    |          |                         |    |          |                         |    |          |                         |    |          |                         |    |          |                         |    |          |                         |    |          |                         |    |          |                         |    |          |                         |    |          |                         |    |          |                         |    |          |                         |    |          |                         |    |          |                         |    |          |                         |    |          |                         |    |          |                         |    |          |                         |    |          |                         |    |          |                         |    |          |                         |    |          |                         |    |          |                         |    |          |                         |    |          |                         |    |          |                         |    |          |                         |    |          |                         |    |          |                         |    |          |                         |    |          |                         |    |          |                         |    |          |                         |    |          |                         |    |          |                         |    |          |                         |    |          |                         |    |          |                         |    |          |                         |    |          |                         |    |          |                         |    |          |                         |    |          |                         |    |          |                         |    |          |                         |    |          |                         |    |          |                         |    |          |                         |    |          |                         |    |          |                         |    |          |                         |    |          |                         |    |          |                         |    |          |                         |    |          |                         |    |          |                         |    |          |                         |    |          |                         |    |          |                         |    |          |                         |    |          |                         |    |          |                         |    |          |                         |    |          |                         |    |          |                         |    |          |                         |    |          |                         |    |          |                         |    |          |                         |    |          |                         |    |          |                         |    |          |                         |    |          |                         |    |          |                         |     |          |                         |  |  |   |
| 30  | 02/12/21   | REVISED AS PER COMMENTS  |  |   |          |                         |   |          |                         |   |          |                         |   |          |                         |   |          |                         |   |          |                         |   |          |                         |   |          |                         |   |          |                         |    |          |                         |    |          |                         |    |          |                         |    |          |                         |    |          |                         |    |          |                         |    |          |                         |    |          |                         |    |          |                         |    |          |                         |    |          |                         |    |          |                         |    |          |                         |    |          |                         |    |          |                         |    |          |                         |    |          |                         |    |          |                         |    |          |                         |    |          |                         |    |          |                         |    |          |                         |    |          |                         |    |          |                         |    |          |                         |    |          |                         |    |          |                         |    |          |                         |    |          |                         |    |          |                         |    |          |                         |    |          |                         |    |          |                         |    |          |                         |    |          |                         |    |          |                         |    |          |                         |    |          |                         |    |          |                         |    |          |                         |    |          |                         |    |          |                         |    |          |                         |    |          |                         |    |          |                         |    |          |                         |    |          |                         |    |          |                         |    |          |                         |    |          |                         |    |          |                         |    |          |                         |    |          |                         |    |          |                         |    |          |                         |    |          |                         |    |          |                         |    |          |                         |    |          |                         |    |          |                         |    |          |                         |    |          |                         |    |          |                         |    |          |                         |    |          |                         |    |          |                         |    |          |                         |    |          |                         |    |          |                         |    |          |                         |    |          |                         |    |          |                         |    |          |                         |    |          |                         |    |          |                         |    |          |                         |    |          |                         |    |          |                         |    |          |                         |    |          |                         |    |          |                         |    |          |                         |    |          |                         |    |          |                         |    |          |                         |    |          |                         |    |          |                         |    |          |                         |    |          |                         |    |          |                         |     |          |                         |  |  |   |
| 31  | 02/12/21   | REVISED AS PER COMMENTS  |  |   |          |                         |   |          |                         |   |          |                         |   |          |                         |   |          |                         |   |          |                         |   |          |                         |   |          |                         |   |          |                         |    |          |                         |    |          |                         |    |          |                         |    |          |                         |    |          |                         |    |          |                         |    |          |                         |    |          |                         |    |          |                         |    |          |                         |    |          |                         |    |          |                         |    |          |                         |    |          |                         |    |          |                         |    |          |                         |    |          |                         |    |          |                         |    |          |                         |    |          |                         |    |          |                         |    |          |                         |    |          |                         |    |          |                         |    |          |                         |    |          |                         |    |          |                         |    |          |                         |    |          |                         |    |          |                         |    |          |                         |    |          |                         |    |          |                         |    |          |                         |    |          |                         |    |          |                         |    |          |                         |    |          |                         |    |          |                         |    |          |                         |    |          |                         |    |          |                         |    |          |                         |    |          |                         |    |          |                         |    |          |                         |    |          |                         |    |          |                         |    |          |                         |    |          |                         |    |          |                         |    |          |                         |    |          |                         |    |          |                         |    |          |                         |    |          |                         |    |          |                         |    |          |                         |    |          |                         |    |          |                         |    |          |                         |    |          |                         |    |          |                         |    |          |                         |    |          |                         |    |          |                         |    |          |                         |    |          |                         |    |          |                         |    |          |                         |    |          |                         |    |          |                         |    |          |                         |    |          |                         |    |          |                         |    |          |                         |    |          |                         |    |          |                         |    |          |                         |    |          |                         |    |          |                         |    |          |                         |    |          |                         |    |          |                         |    |          |                         |    |          |                         |    |          |                         |    |          |                         |    |          |                         |    |          |                         |     |          |                         |  |  |   |
| 32  | 02/12/21   | REVISED AS PER COMMENTS  |  |   |          |                         |   |          |                         |   |          |                         |   |          |                         |   |          |                         |   |          |                         |   |          |                         |   |          |                         |   |          |                         |    |          |                         |    |          |                         |    |          |                         |    |          |                         |    |          |                         |    |          |                         |    |          |                         |    |          |                         |    |          |                         |    |          |                         |    |          |                         |    |          |                         |    |          |                         |    |          |                         |    |          |                         |    |          |                         |    |          |                         |    |          |                         |    |          |                         |    |          |                         |    |          |                         |    |          |                         |    |          |                         |    |          |                         |    |          |                         |    |          |                         |    |          |                         |    |          |                         |    |          |                         |    |          |                         |    |          |                         |    |          |                         |    |          |                         |    |          |                         |    |          |                         |    |          |                         |    |          |                         |    |          |                         |    |          |                         |    |          |                         |    |          |                         |    |          |                         |    |          |                         |    |          |                         |    |          |                         |    |          |                         |    |          |                         |    |          |                         |    |          |                         |    |          |                         |    |          |                         |    |          |                         |    |          |                         |    |          |                         |    |          |                         |    |          |                         |    |          |                         |    |          |                         |    |          |                         |    |          |                         |    |          |                         |    |          |                         |    |          |                         |    |          |                         |    |          |                         |    |          |                         |    |          |                         |    |          |                         |    |          |                         |    |          |                         |    |          |                         |    |          |                         |    |          |                         |    |          |                         |    |          |                         |    |          |                         |    |          |                         |    |          |                         |    |          |                         |    |          |                         |    |          |                         |    |          |                         |    |          |                         |    |          |                         |    |          |                         |    |          |                         |    |          |                         |    |          |                         |    |          |                         |    |          |                         |     |          |                         |  |  |   |
| 33  | 02/12/21   | REVISED AS PER COMMENTS  |  |   |          |                         |   |          |                         |   |          |                         |   |          |                         |   |          |                         |   |          |                         |   |          |                         |   |          |                         |   |          |                         |    |          |                         |    |          |                         |    |          |                         |    |          |                         |    |          |                         |    |          |                         |    |          |                         |    |          |                         |    |          |                         |    |          |                         |    |          |                         |    |          |                         |    |          |                         |    |          |                         |    |          |                         |    |          |                         |    |          |                         |    |          |                         |    |          |                         |    |          |                         |    |          |                         |    |          |                         |    |          |                         |    |          |                         |    |          |                         |    |          |                         |    |          |                         |    |          |                         |    |          |                         |    |          |                         |    |          |                         |    |          |                         |    |          |                         |    |          |                         |    |          |                         |    |          |                         |    |          |                         |    |          |                         |    |          |                         |    |          |                         |    |          |                         |    |          |                         |    |          |                         |    |          |                         |    |          |                         |    |          |                         |    |          |                         |    |          |                         |    |          |                         |    |          |                         |    |          |                         |    |          |                         |    |          |                         |    |          |                         |    |          |                         |    |          |                         |    |          |                         |    |          |                         |    |          |                         |    |          |                         |    |          |                         |    |          |                         |    |          |                         |    |          |                         |    |          |                         |    |          |                         |    |          |                         |    |          |                         |    |          |                         |    |          |                         |    |          |                         |    |          |                         |    |          |                         |    |          |                         |    |          |                         |    |          |                         |    |          |                         |    |          |                         |    |          |                         |    |          |                         |    |          |                         |    |          |                         |    |          |                         |    |          |                         |    |          |                         |    |          |                         |    |          |                         |    |          |                         |    |          |                         |    |          |                         |     |          |                         |  |  |   |
| 34  | 02/12/21   | REVISED AS PER COMMENTS  |  |   |          |                         |   |          |                         |   |          |                         |   |          |                         |   |          |                         |   |          |                         |   |          |                         |   |          |                         |   |          |                         |    |          |                         |    |          |                         |    |          |                         |    |          |                         |    |          |                         |    |          |                         |    |          |                         |    |          |                         |    |          |                         |    |          |                         |    |          |                         |    |          |                         |    |          |                         |    |          |                         |    |          |                         |    |          |                         |    |          |                         |    |          |                         |    |          |                         |    |          |                         |    |          |                         |    |          |                         |    |          |                         |    |          |                         |    |          |                         |    |          |                         |    |          |                         |    |          |                         |    |          |                         |    |          |                         |    |          |                         |    |          |                         |    |          |                         |    |          |                         |    |          |                         |    |          |                         |    |          |                         |    |          |                         |    |          |                         |    |          |                         |    |          |                         |    |          |                         |    |          |                         |    |          |                         |    |          |                         |    |          |                         |    |          |                         |    |          |                         |    |          |                         |    |          |                         |    |          |                         |    |          |                         |    |          |                         |    |          |                         |    |          |                         |    |          |                         |    |          |                         |    |          |                         |    |          |                         |    |          |                         |    |          |                         |    |          |                         |    |          |                         |    |          |                         |    |          |                         |    |          |                         |    |          |                         |    |          |                         |    |          |                         |    |          |                         |    |          |                         |    |          |                         |    |          |                         |    |          |                         |    |          |                         |    |          |                         |    |          |                         |    |          |                         |    |          |                         |    |          |                         |    |          |                         |    |          |                         |    |          |                         |    |          |                         |    |          |                         |    |          |                         |    |          |                         |    |          |                         |    |          |                         |    |          |                         |     |          |                         |  |  |   |
| 35  | 02/12/21   | REVISED AS PER COMMENTS  |  |   |          |                         |   |          |                         |   |          |                         |   |          |                         |   |          |                         |   |          |                         |   |          |                         |   |          |                         |   |          |                         |    |          |                         |    |          |                         |    |          |                         |    |          |                         |    |          |                         |    |          |                         |    |          |                         |    |          |                         |    |          |                         |    |          |                         |    |          |                         |    |          |                         |    |          |                         |    |          |                         |    |          |                         |    |          |                         |    |          |                         |    |          |                         |    |          |                         |    |          |                         |    |          |                         |    |          |                         |    |          |                         |    |          |                         |    |          |                         |    |          |                         |    |          |                         |    |          |                         |    |          |                         |    |          |                         |    |          |                         |    |          |                         |    |          |                         |    |          |                         |    |          |                         |    |          |                         |    |          |                         |    |          |                         |    |          |                         |    |          |                         |    |          |                         |    |          |                         |    |          |                         |    |          |                         |    |          |                         |    |          |                         |    |          |                         |    |          |                         |    |          |                         |    |          |                         |    |          |                         |    |          |                         |    |          |                         |    |          |                         |    |          |                         |    |          |                         |    |          |                         |    |          |                         |    |          |                         |    |          |                         |    |          |                         |    |          |                         |    |          |                         |    |          |                         |    |          |                         |    |          |                         |    |          |                         |    |          |                         |    |          |                         |    |          |                         |    |          |                         |    |          |                         |    |          |                         |    |          |                         |    |          |                         |    |          |                         |    |          |                         |    |          |                         |    |          |                         |    |          |                         |    |          |                         |    |          |                         |    |          |                         |    |          |                         |    |          |                         |    |          |                         |    |          |                         |    |          |                         |    |          |                         |    |          |                         |     |          |                         |  |  |   |
| 36  | 02/12/21   | REVISED AS PER COMMENTS  |  |   |          |                         |   |          |                         |   |          |                         |   |          |                         |   |          |                         |   |          |                         |   |          |                         |   |          |                         |   |          |                         |    |          |                         |    |          |                         |    |          |                         |    |          |                         |    |          |                         |    |          |                         |    |          |                         |    |          |                         |    |          |                         |    |          |                         |    |          |                         |    |          |                         |    |          |                         |    |          |                         |    |          |                         |    |          |                         |    |          |                         |    |          |                         |    |          |                         |    |          |                         |    |          |                         |    |          |                         |    |          |                         |    |          |                         |    |          |                         |    |          |                         |    |          |                         |    |          |                         |    |          |                         |    |          |                         |    |          |                         |    |          |                         |    |          |                         |    |          |                         |    |          |                         |    |          |                         |    |          |                         |    |          |                         |    |          |                         |    |          |                         |    |          |                         |    |          |                         |    |          |                         |    |          |                         |    |          |                         |    |          |                         |    |          |                         |    |          |                         |    |          |                         |    |          |                         |    |          |                         |    |          |                         |    |          |                         |    |          |                         |    |          |                         |    |          |                         |    |          |                         |    |          |                         |    |          |                         |    |          |                         |    |          |                         |    |          |                         |    |          |                         |    |          |                         |    |          |                         |    |          |                         |    |          |                         |    |          |                         |    |          |                         |    |          |                         |    |          |                         |    |          |                         |    |          |                         |    |          |                         |    |          |                         |    |          |                         |    |          |                         |    |          |                         |    |          |                         |    |          |                         |    |          |                         |    |          |                         |    |          |                         |    |          |                         |    |          |                         |    |          |                         |    |          |                         |    |          |                         |    |          |                         |    |          |                         |     |          |                         |  |  |   |
| 37  | 02/12/21   | REVISED AS PER COMMENTS  |  |   |          |                         |   |          |                         |   |          |                         |   |          |                         |   |          |                         |   |          |                         |   |          |                         |   |          |                         |   |          |                         |    |          |                         |    |          |                         |    |          |                         |    |          |                         |    |          |                         |    |          |                         |    |          |                         |    |          |                         |    |          |                         |    |          |                         |    |          |                         |    |          |                         |    |          |                         |    |          |                         |    |          |                         |    |          |                         |    |          |                         |    |          |                         |    |          |                         |    |          |                         |    |          |                         |    |          |                         |    |          |                         |    |          |                         |    |          |                         |    |          |                         |    |          |                         |    |          |                         |    |          |                         |    |          |                         |    |          |                         |    |          |                         |    |          |                         |    |          |                         |    |          |                         |    |          |                         |    |          |                         |    |          |                         |    |          |                         |    |          |                         |    |          |                         |    |          |                         |    |          |                         |    |          |                         |    |          |                         |    |          |                         |    |          |                         |    |          |                         |    |          |                         |    |          |                         |    |          |                         |    |          |                         |    |          |                         |    |          |                         |    |          |                         |    |          |                         |    |          |                         |    |          |                         |    |          |                         |    |          |                         |    |          |                         |    |          |                         |    |          |                         |    |          |                         |    |          |                         |    |          |                         |    |          |                         |    |          |                         |    |          |                         |    |          |                         |    |          |                         |    |          |                         |    |          |                         |    |          |                         |    |          |                         |    |          |                         |    |          |                         |    |          |                         |    |          |                         |    |          |                         |    |          |                         |    |          |                         |    |          |                         |    |          |                         |    |          |                         |    |          |                         |    |          |                         |    |          |                         |    |          |                         |    |          |                         |     |          |                         |  |  |   |
| 38  | 02/12/21   | REVISED AS PER COMMENTS  |  |   |          |                         |   |          |                         |   |          |                         |   |          |                         |   |          |                         |   |          |                         |   |          |                         |   |          |                         |   |          |                         |    |          |                         |    |          |                         |    |          |                         |    |          |                         |    |          |                         |    |          |                         |    |          |                         |    |          |                         |    |          |                         |    |          |                         |    |          |                         |    |          |                         |    |          |                         |    |          |                         |    |          |                         |    |          |                         |    |          |                         |    |          |                         |    |          |                         |    |          |                         |    |          |                         |    |          |                         |    |          |                         |    |          |                         |    |          |                         |    |          |                         |    |          |                         |    |          |                         |    |          |                         |    |          |                         |    |          |                         |    |          |                         |    |          |                         |    |          |                         |    |          |                         |    |          |                         |    |          |                         |    |          |                         |    |          |                         |    |          |                         |    |          |                         |    |          |                         |    |          |                         |    |          |                         |    |          |                         |    |          |                         |    |          |                         |    |          |                         |    |          |                         |    |          |                         |    |          |                         |    |          |                         |    |          |                         |    |          |                         |    |          |                         |    |          |                         |    |          |                         |    |          |                         |    |          |                         |    |          |                         |    |          |                         |    |          |                         |    |          |                         |    |          |                         |    |          |                         |    |          |                         |    |          |                         |    |          |                         |    |          |                         |    |          |                         |    |          |                         |    |          |                         |    |          |                         |    |          |                         |    |          |                         |    |          |                         |    |          |                         |    |          |                         |    |          |                         |    |          |                         |    |          |                         |    |          |                         |    |          |                         |    |          |                         |    |          |                         |    |          |                         |    |          |                         |    |          |                         |    |          |                         |    |          |                         |     |          |                         |  |  |   |
| 39  | 02/12/21   | REVISED AS PER COMMENTS  |  |   |          |                         |   |          |                         |   |          |                         |   |          |                         |   |          |                         |   |          |                         |   |          |                         |   |          |                         |   |          |                         |    |          |                         |    |          |                         |    |          |                         |    |          |                         |    |          |                         |    |          |                         |    |          |                         |    |          |                         |    |          |                         |    |          |                         |    |          |                         |    |          |                         |    |          |                         |    |          |                         |    |          |                         |    |          |                         |    |          |                         |    |          |                         |    |          |                         |    |          |                         |    |          |                         |    |          |                         |    |          |                         |    |          |                         |    |          |                         |    |          |                         |    |          |                         |    |          |                         |    |          |                         |    |          |                         |    |          |                         |    |          |                         |    |          |                         |    |          |                         |    |          |                         |    |          |                         |    |          |                         |    |          |                         |    |          |                         |    |          |                         |    |          |                         |    |          |                         |    |          |                         |    |          |                         |    |          |                         |    |          |                         |    |          |                         |    |          |                         |    |          |                         |    |          |                         |    |          |                         |    |          |                         |    |          |                         |    |          |                         |    |          |                         |    |          |                         |    |          |                         |    |          |                         |    |          |                         |    |          |                         |    |          |                         |    |          |                         |    |          |                         |    |          |                         |    |          |                         |    |          |                         |    |          |                         |    |          |                         |    |          |                         |    |          |                         |    |          |                         |    |          |                         |    |          |                         |    |          |                         |    |          |                         |    |          |                         |    |          |                         |    |          |                         |    |          |                         |    |          |                         |    |          |                         |    |          |                         |    |          |                         |    |          |                         |    |          |                         |    |          |                         |    |          |                         |    |          |                         |    |          |                         |    |          |                         |     |          |                         |  |  |   |
| 40  | 02/12/21   | REVISED AS PER COMMENTS  |  |   |          |                         |   |          |                         |   |          |                         |   |          |                         |   |          |                         |   |          |                         |   |          |                         |   |          |                         |   |          |                         |    |          |                         |    |          |                         |    |          |                         |    |          |                         |    |          |                         |    |          |                         |    |          |                         |    |          |                         |    |          |                         |    |          |                         |    |          |                         |    |          |                         |    |          |                         |    |          |                         |    |          |                         |    |          |                         |    |          |                         |    |          |                         |    |          |                         |    |          |                         |    |          |                         |    |          |                         |    |          |                         |    |          |                         |    |          |                         |    |          |                         |    |          |                         |    |          |                         |    |          |                         |    |          |                         |    |          |                         |    |          |                         |    |          |                         |    |          |                         |    |          |                         |    |          |                         |    |          |                         |    |          |                         |    |          |                         |    |          |                         |    |          |                         |    |          |                         |    |          |                         |    |          |                         |    |          |                         |    |          |                         |    |          |                         |    |          |                         |    |          |                         |    |          |                         |    |          |                         |    |          |                         |    |          |                         |    |          |                         |    |          |                         |    |          |                         |    |          |                         |    |          |                         |    |          |                         |    |          |                         |    |          |                         |    |          |                         |    |          |                         |    |          |                         |    |          |                         |    |          |                         |    |          |                         |    |          |                         |    |          |                         |    |          |                         |    |          |                         |    |          |                         |    |          |                         |    |          |                         |    |          |                         |    |          |                         |    |          |                         |    |          |                         |    |          |                         |    |          |                         |    |          |                         |    |          |                         |    |          |                         |    |          |                         |    |          |                         |    |          |                         |    |          |                         |    |          |                         |    |          |                         |    |          |                         |     |          |                         |  |  |   |
| 41  | 02/12/21   | REVISED AS PER COMMENTS  |  |   |          |                         |   |          |                         |   |          |                         |   |          |                         |   |          |                         |   |          |                         |   |          |                         |   |          |                         |   |          |                         |    |          |                         |    |          |                         |    |          |                         |    |          |                         |    |          |                         |    |          |                         |    |          |                         |    |          |                         |    |          |                         |    |          |                         |    |          |                         |    |          |                         |    |          |                         |    |          |                         |    |          |                         |    |          |                         |    |          |                         |    |          |                         |    |          |                         |    |          |                         |    |          |                         |    |          |                         |    |          |                         |    |          |                         |    |          |                         |    |          |                         |    |          |                         |    |          |                         |    |          |                         |    |          |                         |    |          |                         |    |          |                         |    |          |                         |    |          |                         |    |          |                         |    |          |                         |    |          |                         |    |          |                         |    |          |                         |    |          |                         |    |          |                         |    |          |                         |    |          |                         |    |          |                         |    |          |                         |    |          |                         |    |          |                         |    |          |                         |    |          |                         |    |          |                         |    |          |                         |    |          |                         |    |          |                         |    |          |                         |    |          |                         |    |          |                         |    |          |                         |    |          |                         |    |          |                         |    |          |                         |    |          |                         |    |          |                         |    |          |                         |    |          |                         |    |          |                         |    |          |                         |    |          |                         |    |          |                         |    |          |                         |    |          |                         |    |          |                         |    |          |                         |    |          |                         |    |          |                         |    |          |                         |    |          |                         |    |          |                         |    |          |                         |    |          |                         |    |          |                         |    |          |                         |    |          |                         |    |          |                         |    |          |                         |    |          |                         |    |          |                         |    |          |                         |    |          |                         |    |          |                         |    |          |                         |     |          |                         |  |  |   |
| 42  | 02/12/21   | REVISED AS PER COMMENTS  |  |   |          |                         |   |          |                         |   |          |                         |   |          |                         |   |          |                         |   |          |                         |   |          |                         |   |          |                         |   |          |                         |    |          |                         |    |          |                         |    |          |                         |    |          |                         |    |          |                         |    |          |                         |    |          |                         |    |          |                         |    |          |                         |    |          |                         |    |          |                         |    |          |                         |    |          |                         |    |          |                         |    |          |                         |    |          |                         |    |          |                         |    |          |                         |    |          |                         |    |          |                         |    |          |                         |    |          |                         |    |          |                         |    |          |                         |    |          |                         |    |          |                         |    |          |                         |    |          |                         |    |          |                         |    |          |                         |    |          |                         |    |          |                         |    |          |                         |    |          |                         |    |          |                         |    |          |                         |    |          |                         |    |          |                         |    |          |                         |    |          |                         |    |          |                         |    |          |                         |    |          |                         |    |          |                         |    |          |                         |    |          |                         |    |          |                         |    |          |                         |    |          |                         |    |          |                         |    |          |                         |    |          |                         |    |          |                         |    |          |                         |    |          |                         |    |          |                         |    |          |                         |    |          |                         |    |          |                         |    |          |                         |    |          |                         |    |          |                         |    |          |                         |    |          |                         |    |          |                         |    |          |                         |    |          |                         |    |          |                         |    |          |                         |    |          |                         |    |          |                         |    |          |                         |    |          |                         |    |          |                         |    |          |                         |    |          |                         |    |          |                         |    |          |                         |    |          |                         |    |          |                         |    |          |                         |    |          |                         |    |          |                         |    |          |                         |    |          |                         |    |          |                         |    |          |                         |    |          |                         |    |          |                         |    |          |                         |     |          |                         |  |  |   |
| 43  | 02/12/21   | REVISED AS PER COMMENTS  |  |   |          |                         |   |          |                         |   |          |                         |   |          |                         |   |          |                         |   |          |                         |   |          |                         |   |          |                         |   |          |                         |    |          |                         |    |          |                         |    |          |                         |    |          |                         |    |          |                         |    |          |                         |    |          |                         |    |          |                         |    |          |                         |    |          |                         |    |          |                         |    |          |                         |    |          |                         |    |          |                         |    |          |                         |    |          |                         |    |          |                         |    |          |                         |    |          |                         |    |          |                         |    |          |                         |    |          |                         |    |          |                         |    |          |                         |    |          |                         |    |          |                         |    |          |                         |    |          |                         |    |          |                         |    |          |                         |    |          |                         |    |          |                         |    |          |                         |    |          |                         |    |          |                         |    |          |                         |    |          |                         |    |          |                         |    |          |                         |    |          |                         |    |          |                         |    |          |                         |    |          |                         |    |          |                         |    |          |                         |    |          |                         |    |          |                         |    |          |                         |    |          |                         |    |          |                         |    |          |                         |    |          |                         |    |          |                         |    |          |                         |    |          |                         |    |          |                         |    |          |                         |    |          |                         |    |          |                         |    |          |                         |    |          |                         |    |          |                         |    |          |                         |    |          |                         |    |          |                         |    |          |                         |    |          |                         |    |          |                         |    |          |                         |    |          |                         |    |          |                         |    |          |                         |    |          |                         |    |          |                         |    |          |                         |    |          |                         |    |          |                         |    |          |                         |    |          |                         |    |          |                         |    |          |                         |    |          |                         |    |          |                         |    |          |                         |    |          |                         |    |          |                         |    |          |                         |    |          |                         |    |          |                         |    |          |                         |     |          |                         |  |  |   |
| 44  | 02/12/21   | REVISED AS PER COMMENTS  |  |   |          |                         |   |          |                         |   |          |                         |   |          |                         |   |          |                         |   |          |                         |   |          |                         |   |          |                         |   |          |                         |    |          |                         |    |          |                         |    |          |                         |    |          |                         |    |          |                         |    |          |                         |    |          |                         |    |          |                         |    |          |                         |    |          |                         |    |          |                         |    |          |                         |    |          |                         |    |          |                         |    |          |                         |    |          |                         |    |          |                         |    |          |                         |    |          |                         |    |          |                         |    |          |                         |    |          |                         |    |          |                         |    |          |                         |    |          |                         |    |          |                         |    |          |                         |    |          |                         |    |          |                         |    |          |                         |    |          |                         |    |          |                         |    |          |                         |    |          |                         |    |          |                         |    |          |                         |    |          |                         |    |          |                         |    |          |                         |    |          |                         |    |          |                         |    |          |                         |    |          |                         |    |          |                         |    |          |                         |    |          |                         |    |          |                         |    |          |                         |    |          |                         |    |          |                         |    |          |                         |    |          |                         |    |          |                         |    |          |                         |    |          |                         |    |          |                         |    |          |                         |    |          |                         |    |          |                         |    |          |                         |    |          |                         |    |          |                         |    |          |                         |    |          |                         |    |          |                         |    |          |                         |    |          |                         |    |          |                         |    |          |                         |    |          |                         |    |          |                         |    |          |                         |    |          |                         |    |          |                         |    |          |                         |    |          |                         |    |          |                         |    |          |                         |    |          |                         |    |          |                         |    |          |                         |    |          |                         |    |          |                         |    |          |                         |    |          |                         |    |          |                         |    |          |                         |    |          |                         |    |          |                         |    |          |                         |     |          |                         |  |  |   |
| 45  | 02/12/21   | REVISED AS PER COMMENTS  |  |   |          |                         |   |          |                         |   |          |                         |   |          |                         |   |          |                         |   |          |                         |   |          |                         |   |          |                         |   |          |                         |    |          |                         |    |          |                         |    |          |                         |    |          |                         |    |          |                         |    |          |                         |    |          |                         |    |          |                         |    |          |                         |    |          |                         |    |          |                         |    |          |                         |    |          |                         |    |          |                         |    |          |                         |    |          |                         |    |          |                         |    |          |                         |    |          |                         |    |          |                         |    |          |                         |    |          |                         |    |          |                         |    |          |                         |    |          |                         |    |          |                         |    |          |                         |    |          |                         |    |          |                         |    |          |                         |    |          |                         |    |          |                         |    |          |                         |    |          |                         |    |          |                         |    |          |                         |    |          |                         |    |          |                         |    |          |                         |    |          |                         |    |          |                         |    |          |                         |    |          |                         |    |          |                         |    |          |                         |    |          |                         |    |          |                         |    |          |                         |    |          |                         |    |          |                         |    |          |                         |    |          |                         |    |          |                         |    |          |                         |    |          |                         |    |          |                         |    |          |                         |    |          |                         |    |          |                         |    |          |                         |    |          |                         |    |          |                         |    |          |                         |    |          |                         |    |          |                         |    |          |                         |    |          |                         |    |          |                         |    |          |                         |    |          |                         |    |          |                         |    |          |                         |    |          |                         |    |          |                         |    |          |                         |    |          |                         |    |          |                         |    |          |                         |    |          |                         |    |          |                         |    |          |                         |    |          |                         |    |          |                         |    |          |                         |    |          |                         |    |          |                         |    |          |                         |    |          |                         |    |          |                         |    |          |                         |     |          |                         |  |  |   |
| 46  | 02/12/21   | REVISED AS PER COMMENTS  |  |   |          |                         |   |          |                         |   |          |                         |   |          |                         |   |          |                         |   |          |                         |   |          |                         |   |          |                         |   |          |                         |    |          |                         |    |          |                         |    |          |                         |    |          |                         |    |          |                         |    |          |                         |    |          |                         |    |          |                         |    |          |                         |    |          |                         |    |          |                         |    |          |                         |    |          |                         |    |          |                         |    |          |                         |    |          |                         |    |          |                         |    |          |                         |    |          |                         |    |          |                         |    |          |                         |    |          |                         |    |          |                         |    |          |                         |    |          |                         |    |          |                         |    |          |                         |    |          |                         |    |          |                         |    |          |                         |    |          |                         |    |          |                         |    |          |                         |    |          |                         |    |          |                         |    |          |                         |    |          |                         |    |          |                         |    |          |                         |    |          |                         |    |          |                         |    |          |                         |    |          |                         |    |          |                         |    |          |                         |    |          |                         |    |          |                         |    |          |                         |    |          |                         |    |          |                         |    |          |                         |    |          |                         |    |          |                         |    |          |                         |    |          |                         |    |          |                         |    |          |                         |    |          |                         |    |          |                         |    |          |                         |    |          |                         |    |          |                         |    |          |                         |    |          |                         |    |          |                         |    |          |                         |    |          |                         |    |          |                         |    |          |                         |    |          |                         |    |          |                         |    |          |                         |    |          |                         |    |          |                         |    |          |                         |    |          |                         |    |          |                         |    |          |                         |    |          |                         |    |          |                         |    |          |                         |    |          |                         |    |          |                         |    |          |                         |    |          |                         |    |          |                         |    |          |                         |    |          |                         |    |          |                         |    |          |                         |     |          |                         |  |  |   |
| 47  | 02/12/21   | REVISED AS PER COMMENTS  |  |   |          |                         |   |          |                         |   |          |                         |   |          |                         |   |          |                         |   |          |                         |   |          |                         |   |          |                         |   |          |                         |    |          |                         |    |          |                         |    |          |                         |    |          |                         |    |          |                         |    |          |                         |    |          |                         |    |          |                         |    |          |                         |    |          |                         |    |          |                         |    |          |                         |    |          |                         |    |          |                         |    |          |                         |    |          |                         |    |          |                         |    |          |                         |    |          |                         |    |          |                         |    |          |                         |    |          |                         |    |          |                         |    |          |                         |    |          |                         |    |          |                         |    |          |                         |    |          |                         |    |          |                         |    |          |                         |    |          |                         |    |          |                         |    |          |                         |    |          |                         |    |          |                         |    |          |                         |    |          |                         |    |          |                         |    |          |                         |    |          |                         |    |          |                         |    |          |                         |    |          |                         |    |          |                         |    |          |                         |    |          |                         |    |          |                         |    |          |                         |    |          |                         |    |          |                         |    |          |                         |    |          |                         |    |          |                         |    |          |                         |    |          |                         |    |          |                         |    |          |                         |    |          |                         |    |          |                         |    |          |                         |    |          |                         |    |          |                         |    |          |                         |    |          |                         |    |          |                         |    |          |                         |    |          |                         |    |          |                         |    |          |                         |    |          |                         |    |          |                         |    |          |                         |    |          |                         |    |          |                         |    |          |                         |    |          |                         |    |          |                         |    |          |                         |    |          |                         |    |          |                         |    |          |                         |    |          |                         |    |          |                         |    |          |                         |    |          |                         |    |          |                         |    |          |                         |    |          |                         |    |          |                         |    |          |                         |     |          |                         |  |  |   |
| 48  | 02/12/21   | REVISED AS PER COMMENTS  |  |   |          |                         |   |          |                         |   |          |                         |   |          |                         |   |          |                         |   |          |                         |   |          |                         |   |          |                         |   |          |                         |    |          |                         |    |          |                         |    |          |                         |    |          |                         |    |          |                         |    |          |                         |    |          |                         |    |          |                         |    |          |                         |    |          |                         |    |          |                         |    |          |                         |    |          |                         |    |          |                         |    |          |                         |    |          |                         |    |          |                         |    |          |                         |    |          |                         |    |          |                         |    |          |                         |    |          |                         |    |          |                         |    |          |                         |    |          |                         |    |          |                         |    |          |                         |    |          |                         |    |          |                         |    |          |                         |    |          |                         |    |          |                         |    |          |                         |    |          |                         |    |          |                         |    |          |                         |    |          |                         |    |          |                         |    |          |                         |    |          |                         |    |          |                         |    |          |                         |    |          |                         |    |          |                         |    |          |                         |    |          |                         |    |          |                         |    |          |                         |    |          |                         |    |          |                         |    |          |                         |    |          |                         |    |          |                         |    |          |                         |    |          |                         |    |          |                         |    |          |                         |    |          |                         |    |          |                         |    |          |                         |    |          |                         |    |          |                         |    |          |                         |    |          |                         |    |          |                         |    |          |                         |    |          |                         |    |          |                         |    |          |                         |    |          |                         |    |          |                         |    |          |                         |    |          |                         |    |          |                         |    |          |                         |    |          |                         |    |          |                         |    |          |                         |    |          |                         |    |          |                         |    |          |                         |    |          |                         |    |          |                         |    |          |                         |    |          |                         |    |          |                         |    |          |                         |    |          |                         |    |          |                         |    |          |                         |     |          |                         |  |  |   |
| 49  | 02/12/21   | REVISED AS PER COMMENTS  |  |   |          |                         |   |          |                         |   |          |                         |   |          |                         |   |          |                         |   |          |                         |   |          |                         |   |          |                         |   |          |                         |    |          |                         |    |          |                         |    |          |                         |    |          |                         |    |          |                         |    |          |                         |    |          |                         |    |          |                         |    |          |                         |    |          |                         |    |          |                         |    |          |                         |    |          |                         |    |          |                         |    |          |                         |    |          |                         |    |          |                         |    |          |                         |    |          |                         |    |          |                         |    |          |                         |    |          |                         |    |          |                         |    |          |                         |    |          |                         |    |          |                         |    |          |                         |    |          |                         |    |          |                         |    |          |                         |    |          |                         |    |          |                         |    |          |                         |    |          |                         |    |          |                         |    |          |                         |    |          |                         |    |          |                         |    |          |                         |    |          |                         |    |          |                         |    |          |                         |    |          |                         |    |          |                         |    |          |                         |    |          |                         |    |          |                         |    |          |                         |    |          |                         |    |          |                         |    |          |                         |    |          |                         |    |          |                         |    |          |                         |    |          |                         |    |          |                         |    |          |                         |    |          |                         |    |          |                         |    |          |                         |    |          |                         |    |          |                         |    |          |                         |    |          |                         |    |          |                         |    |          |                         |    |          |                         |    |          |                         |    |          |                         |    |          |                         |    |          |                         |    |          |                         |    |          |                         |    |          |                         |    |          |                         |    |          |                         |    |          |                         |    |          |                         |    |          |                         |    |          |                         |    |          |                         |    |          |                         |    |          |                         |    |          |                         |    |          |                         |    |          |                         |    |          |                         |    |          |                         |    |          |                         |    |          |                         |     |          |                         |  |  |   |
| 50  | 02/12/21   | REVISED AS PER COMMENTS  |  |   |          |                         |   |          |                         |   |          |                         |   |          |                         |   |          |                         |   |          |                         |   |          |                         |   |          |                         |   |          |                         |    |          |                         |    |          |                         |    |          |                         |    |          |                         |    |          |                         |    |          |                         |    |          |                         |    |          |                         |    |          |                         |    |          |                         |    |          |                         |    |          |                         |    |          |                         |    |          |                         |    |          |                         |    |          |                         |    |          |                         |    |          |                         |    |          |                         |    |          |                         |    |          |                         |    |          |                         |    |          |                         |    |          |                         |    |          |                         |    |          |                         |    |          |                         |    |          |                         |    |          |                         |    |          |                         |    |          |                         |    |          |                         |    |          |                         |    |          |                         |    |          |                         |    |          |                         |    |          |                         |    |          |                         |    |          |                         |    |          |                         |    |          |                         |    |          |                         |    |          |                         |    |          |                         |    |          |                         |    |          |                         |    |          |                         |    |          |                         |    |          |                         |    |          |                         |    |          |                         |    |          |                         |    |          |                         |    |          |                         |    |          |                         |    |          |                         |    |          |                         |    |          |                         |    |          |                         |    |          |                         |    |          |                         |    |          |                         |    |          |                         |    |          |                         |    |          |                         |    |          |                         |    |          |                         |    |          |                         |    |          |                         |    |          |                         |    |          |                         |    |          |                         |    |          |                         |    |          |                         |    |          |                         |    |          |                         |    |          |                         |    |          |                         |    |          |                         |    |          |                         |    |          |                         |    |          |                         |    |          |                         |    |          |                         |    |          |                         |    |          |                         |    |          |                         |    |          |                         |    |          |                         |    |          |                         |     |          |                         |  |  |   |
| 51  | 02/12/21   | REVISED AS PER COMMENTS  |  |   |          |                         |   |          |                         |   |          |                         |   |          |                         |   |          |                         |   |          |                         |   |          |                         |   |          |                         |   |          |                         |    |          |                         |    |          |                         |    |          |                         |    |          |                         |    |          |                         |    |          |                         |    |          |                         |    |          |                         |    |          |                         |    |          |                         |    |          |                         |    |          |                         |    |          |                         |    |          |                         |    |          |                         |    |          |                         |    |          |                         |    |          |                         |    |          |                         |    |          |                         |    |          |                         |    |          |                         |    |          |                         |    |          |                         |    |          |                         |    |          |                         |    |          |                         |    |          |                         |    |          |                         |    |          |                         |    |          |                         |    |          |                         |    |          |                         |    |          |                         |    |          |                         |    |          |                         |    |          |                         |    |          |                         |    |          |                         |    |          |                         |    |          |                         |    |          |                         |    |          |                         |    |          |                         |    |          |                         |    |          |                         |    |          |                         |    |          |                         |    |          |                         |    |          |                         |    |          |                         |    |          |                         |    |          |                         |    |          |                         |    |          |                         |    |          |                         |    |          |                         |    |          |                         |    |          |                         |    |          |                         |    |          |                         |    |          |                         |    |          |                         |    |          |                         |    |          |                         |    |          |                         |    |          |                         |    |          |                         |    |          |                         |    |          |                         |    |          |                         |    |          |                         |    |          |                         |    |          |                         |    |          |                         |    |          |                         |    |          |                         |    |          |                         |    |          |                         |    |          |                         |    |          |                         |    |          |                         |    |          |                         |    |          |                         |    |          |                         |    |          |                         |    |          |                         |    |          |                         |    |          |                         |    |          |                         |     |          |                         |  |  |   |
| 52  | 02/12/21   | REVISED AS PER COMMENTS  |  |   |          |                         |   |          |                         |   |          |                         |   |          |                         |   |          |                         |   |          |                         |   |          |                         |   |          |                         |   |          |                         |    |          |                         |    |          |                         |    |          |                         |    |          |                         |    |          |                         |    |          |                         |    |          |                         |    |          |                         |    |          |                         |    |          |                         |    |          |                         |    |          |                         |    |          |                         |    |          |                         |    |          |                         |    |          |                         |    |          |                         |    |          |                         |    |          |                         |    |          |                         |    |          |                         |    |          |                         |    |          |                         |    |          |                         |    |          |                         |    |          |                         |    |          |                         |    |          |                         |    |          |                         |    |          |                         |    |          |                         |    |          |                         |    |          |                         |    |          |                         |    |          |                         |    |          |                         |    |          |                         |    |          |                         |    |          |                         |    |          |                         |    |          |                         |    |          |                         |    |          |                         |    |          |                         |    |          |                         |    |          |                         |    |          |                         |    |          |                         |    |          |                         |    |          |                         |    |          |                         |    |          |                         |    |          |                         |    |          |                         |    |          |                         |    |          |                         |    |          |                         |    |          |                         |    |          |                         |    |          |                         |    |          |                         |    |          |                         |    |          |                         |    |          |                         |    |          |                         |    |          |                         |    |          |                         |    |          |                         |    |          |                         |    |          |                         |    |          |                         |    |          |                         |    |          |                         |    |          |                         |    |          |                         |    |          |                         |    |          |                         |    |          |                         |    |          |                         |    |          |                         |    |          |                         |    |          |                         |    |          |                         |    |          |                         |    |          |                         |    |          |                         |    |          |                         |    |          |                         |    |          |                         |    |          |                         |     |          |                         |  |  |   |
| 53  | 02/12/21   | REVISED AS PER COMMENTS  |  |   |          |                         |   |          |                         |   |          |                         |   |          |                         |   |          |                         |   |          |                         |   |          |                         |   |          |                         |   |          |                         |    |          |                         |    |          |                         |    |          |                         |    |          |                         |    |          |                         |    |          |                         |    |          |                         |    |          |                         |    |          |                         |    |          |                         |    |          |                         |    |          |                         |    |          |                         |    |          |                         |    |          |                         |    |          |                         |    |          |                         |    |          |                         |    |          |                         |    |          |                         |    |          |                         |    |          |                         |    |          |                         |    |          |                         |    |          |                         |    |          |                         |    |          |                         |    |          |                         |    |          |                         |    |          |                         |    |          |                         |    |          |                         |    |          |                         |    |          |                         |    |          |                         |    |          |                         |    |          |                         |    |          |                         |    |          |                         |    |          |                         |    |          |                         |    |          |                         |    |          |                         |    |          |                         |    |          |                         |    |          |                         |    |          |                         |    |          |                         |    |          |                         |    |          |                         |    |          |                         |    |          |                         |    |          |                         |    |          |                         |    |          |                         |    |          |                         |    |          |                         |    |          |                         |    |          |                         |    |          |                         |    |          |                         |    |          |                         |    |          |                         |    |          |                         |    |          |                         |    |          |                         |    |          |                         |    |          |                         |    |          |                         |    |          |                         |    |          |                         |    |          |                         |    |          |                         |    |          |                         |    |          |                         |    |          |                         |    |          |                         |    |          |                         |    |          |                         |    |          |                         |    |          |                         |    |          |                         |    |          |                         |    |          |                         |    |          |                         |    |          |                         |    |          |                         |    |          |                         |    |          |                         |    |          |                         |     |          |                         |  |  |   |
| 54  | 02/12/21   | REVISED AS PER COMMENTS  |  |   |          |                         |   |          |                         |   |          |                         |   |          |                         |   |          |                         |   |          |                         |   |          |                         |   |          |                         |   |          |                         |    |          |                         |    |          |                         |    |          |                         |    |          |                         |    |          |                         |    |          |                         |    |          |                         |    |          |                         |    |          |                         |    |          |                         |    |          |                         |    |          |                         |    |          |                         |    |          |                         |    |          |                         |    |          |                         |    |          |                         |    |          |                         |    |          |                         |    |          |                         |    |          |                         |    |          |                         |    |          |                         |    |          |                         |    |          |                         |    |          |                         |    |          |                         |    |          |                         |    |          |                         |    |          |                         |    |          |                         |    |          |                         |    |          |                         |    |          |                         |    |          |                         |    |          |                         |    |          |                         |    |          |                         |    |          |                         |    |          |                         |    |          |                         |    |          |                         |    |          |                         |    |          |                         |    |          |                         |    |          |                         |    |          |                         |    |          |                         |    |          |                         |    |          |                         |    |          |                         |    |          |                         |    |          |                         |    |          |                         |    |          |                         |    |          |                         |    |          |                         |    |          |                         |    |          |                         |    |          |                         |    |          |                         |    |          |                         |    |          |                         |    |          |                         |    |          |                         |    |          |                         |    |          |                         |    |          |                         |    |          |                         |    |          |                         |    |          |                         |    |          |                         |    |          |                         |    |          |                         |    |          |                         |    |          |                         |    |          |                         |    |          |                         |    |          |                         |    |          |                         |    |          |                         |    |          |                         |    |          |                         |    |          |                         |    |          |                         |    |          |                         |    |          |                         |    |          |                         |    |          |                         |    |          |                         |     |          |                         |  |  |   |
| 55  | 02/12/21   | REVISED AS PER COMMENTS  |  |   |          |                         |   |          |                         |   |          |                         |   |          |                         |   |          |                         |   |          |                         |   |          |                         |   |          |                         |   |          |                         |    |          |                         |    |          |                         |    |          |                         |    |          |                         |    |          |                         |    |          |                         |    |          |                         |    |          |                         |    |          |                         |    |          |                         |    |          |                         |    |          |                         |    |          |                         |    |          |                         |    |          |                         |    |          |                         |    |          |                         |    |          |                         |    |          |                         |    |          |                         |    |          |                         |    |          |                         |    |          |                         |    |          |                         |    |          |                         |    |          |                         |    |          |                         |    |          |                         |    |          |                         |    |          |                         |    |          |                         |    |          |                         |    |          |                         |    |          |                         |    |          |                         |    |          |                         |    |          |                         |    |          |                         |    |          |                         |    |          |                         |    |          |                         |    |          |                         |    |          |                         |    |          |                         |    |          |                         |    |          |                         |    |          |                         |    |          |                         |    |          |                         |    |          |                         |    |          |                         |    |          |                         |    |          |                         |    |          |                         |    |          |                         |    |          |                         |    |          |                         |    |          |                         |    |          |                         |    |          |                         |    |          |                         |    |          |                         |    |          |                         |    |          |                         |    |          |                         |    |          |                         |    |          |                         |    |          |                         |    |          |                         |    |          |                         |    |          |                         |    |          |                         |    |          |                         |    |          |                         |    |          |                         |    |          |                         |    |          |                         |    |          |                         |    |          |                         |    |          |                         |    |          |                         |    |          |                         |    |          |                         |    |          |                         |    |          |                         |    |          |                         |    |          |                         |    |          |                         |    |          |                         |    |          |                         |     |          |                         |  |  |   |
| 56  | 02/12/21   | REVISED AS PER COMMENTS  |  |   |          |                         |   |          |                         |   |          |                         |   |          |                         |   |          |                         |   |          |                         |   |          |                         |   |          |                         |   |          |                         |    |          |                         |    |          |                         |    |          |                         |    |          |                         |    |          |                         |    |          |                         |    |          |                         |    |          |                         |    |          |                         |    |          |                         |    |          |                         |    |          |                         |    |          |                         |    |          |                         |    |          |                         |    |          |                         |    |          |                         |    |          |                         |    |          |                         |    |          |                         |    |          |                         |    |          |                         |    |          |                         |    |          |                         |    |          |                         |    |          |                         |    |          |                         |    |          |                         |    |          |                         |    |          |                         |    |          |                         |    |          |                         |    |          |                         |    |          |                         |    |          |                         |    |          |                         |    |          |                         |    |          |                         |    |          |                         |    |          |                         |    |          |                         |    |          |                         |    |          |                         |    |          |                         |    |          |                         |    |          |                         |    |          |                         |    |          |                         |    |          |                         |    |          |                         |    |          |                         |    |          |                         |    |          |                         |    |          |                         |    |          |                         |    |          |                         |    |          |                         |    |          |                         |    |          |                         |    |          |                         |    |          |                         |    |          |                         |    |          |                         |    |          |                         |    |          |                         |    |          |                         |    |          |                         |    |          |                         |    |          |                         |    |          |                         |    |          |                         |    |          |                         |    |          |                         |    |          |                         |    |          |                         |    |          |                         |    |          |                         |    |          |                         |    |          |                         |    |          |                         |    |          |                         |    |          |                         |    |          |                         |    |          |                         |    |          |                         |    |          |                         |    |          |                         |    |          |                         |    |          |                         |    |          |                         |     |          |                         |  |  |   |
| 57  | 02/12/21   | REVISED AS PER COMMENTS  |  |   |          |                         |   |          |                         |   |          |                         |   |          |                         |   |          |                         |   |          |                         |   |          |                         |   |          |                         |   |          |                         |    |          |                         |    |          |                         |    |          |                         |    |          |                         |    |          |                         |    |          |                         |    |          |                         |    |          |                         |    |          |                         |    |          |                         |    |          |                         |    |          |                         |    |          |                         |    |          |                         |    |          |                         |    |          |                         |    |          |                         |    |          |                         |    |          |                         |    |          |                         |    |          |                         |    |          |                         |    |          |                         |    |          |                         |    |          |                         |    |          |                         |    |          |                         |    |          |                         |    |          |                         |    |          |                         |    |          |                         |    |          |                         |    |          |                         |    |          |                         |    |          |                         |    |          |                         |    |          |                         |    |          |                         |    |          |                         |    |          |                         |    |          |                         |    |          |                         |    |          |                         |    |          |                         |    |          |                         |    |          |                         |    |          |                         |    |          |                         |    |          |                         |    |          |                         |    |          |                         |    |          |                         |    |          |                         |    |          |                         |    |          |                         |    |          |                         |    |          |                         |    |          |                         |    |          |                         |    |          |                         |    |          |                         |    |          |                         |    |          |                         |    |          |                         |    |          |                         |    |          |                         |    |          |                         |    |          |                         |    |          |                         |    |          |                         |    |          |                         |    |          |                         |    |          |                         |    |          |                         |    |          |                         |    |          |                         |    |          |                         |    |          |                         |    |          |                         |    |          |                         |    |          |                         |    |          |                         |    |          |                         |    |          |                         |    |          |                         |    |          |                         |    |          |                         |    |          |                         |    |          |                         |    |          |                         |     |          |                         |  |  |   |
| 58  | 02/12/21   | REVISED AS PER COMMENTS  |  |   |          |                         |   |          |                         |   |          |                         |   |          |                         |   |          |                         |   |          |                         |   |          |                         |   |          |                         |   |          |                         |    |          |                         |    |          |                         |    |          |                         |    |          |                         |    |          |                         |    |          |                         |    |          |                         |    |          |                         |    |          |                         |    |          |                         |    |          |                         |    |          |                         |    |          |                         |    |          |                         |    |          |                         |    |          |                         |    |          |                         |    |          |                         |    |          |                         |    |          |                         |    |          |                         |    |          |                         |    |          |                         |    |          |                         |    |          |                         |    |          |                         |    |          |                         |    |          |                         |    |          |                         |    |          |                         |    |          |                         |    |          |                         |    |          |                         |    |          |                         |    |          |                         |    |          |                         |    |          |                         |    |          |                         |    |          |                         |    |          |                         |    |          |                         |    |          |                         |    |          |                         |    |          |                         |    |          |                         |    |          |                         |    |          |                         |    |          |                         |    |          |                         |    |          |                         |    |          |                         |    |          |                         |    |          |                         |    |          |                         |    |          |                         |    |          |                         |    |          |                         |    |          |                         |    |          |                         |    |          |                         |    |          |                         |    |          |                         |    |          |                         |    |          |                         |    |          |                         |    |          |                         |    |          |                         |    |          |                         |    |          |                         |    |          |                         |    |          |                         |    |          |                         |    |          |                         |    |          |                         |    |          |                         |    |          |                         |    |          |                         |    |          |                         |    |          |                         |    |          |                         |    |          |                         |    |          |                         |    |          |                         |    |          |                         |    |          |                         |    |          |                         |    |          |                         |    |          |                         |    |          |                         |    |          |                         |     |          |                         |  |  |   |
| 59  | 02/12/21   | REVISED AS PER COMMENTS  |  |   |          |                         |   |          |                         |   |          |                         |   |          |                         |   |          |                         |   |          |                         |   |          |                         |   |          |                         |   |          |                         |    |          |                         |    |          |                         |    |          |                         |    |          |                         |    |          |                         |    |          |                         |    |          |                         |    |          |                         |    |          |                         |    |          |                         |    |          |                         |    |          |                         |    |          |                         |    |          |                         |    |          |                         |    |          |                         |    |          |                         |    |          |                         |    |          |                         |    |          |                         |    |          |                         |    |          |                         |    |          |                         |    |          |                         |    |          |                         |    |          |                         |    |          |                         |    |          |                         |    |          |                         |    |          |                         |    |          |                         |    |          |                         |    |          |                         |    |          |                         |    |          |                         |    |          |                         |    |          |                         |    |          |                         |    |          |                         |    |          |                         |    |          |                         |    |          |                         |    |          |                         |    |          |                         |    |          |                         |    |          |                         |    |          |                         |    |          |                         |    |          |                         |    |          |                         |    |          |                         |    |          |                         |    |          |                         |    |          |                         |    |          |                         |    |          |                         |    |          |                         |    |          |                         |    |          |                         |    |          |                         |    |          |                         |    |          |                         |    |          |                         |    |          |                         |    |          |                         |    |          |                         |    |          |                         |    |          |                         |    |          |                         |    |          |                         |    |          |                         |    |          |                         |    |          |                         |    |          |                         |    |          |                         |    |          |                         |    |          |                         |    |          |                         |    |          |                         |    |          |                         |    |          |                         |    |          |                         |    |          |                         |    |          |                         |    |          |                         |    |          |                         |    |          |                         |    |          |                         |    |          |                         |    |          |                         |     |          |                         |  |  |   |
| 60  | 02/12/21   | REVISED AS PER COMMENTS  |  |   |          |                         |   |          |                         |   |          |                         |   |          |                         |   |          |                         |   |          |                         |   |          |                         |   |          |                         |   |          |                         |    |          |                         |    |          |                         |    |          |                         |    |          |                         |    |          |                         |    |          |                         |    |          |                         |    |          |                         |    |          |                         |    |          |                         |    |          |                         |    |          |                         |    |          |                         |    |          |                         |    |          |                         |    |          |                         |    |          |                         |    |          |                         |    |          |                         |    |          |                         |    |          |                         |    |          |                         |    |          |                         |    |          |                         |    |          |                         |    |          |                         |    |          |                         |    |          |                         |    |          |                         |    |          |                         |    |          |                         |    |          |                         |    |          |                         |    |          |                         |    |          |                         |    |          |                         |    |          |                         |    |          |                         |    |          |                         |    |          |                         |    |          |                         |    |          |                         |    |          |                         |    |          |                         |    |          |                         |    |          |                         |    |          |                         |    |          |                         |    |          |                         |    |          |                         |    |          |                         |    |          |                         |    |          |                         |    |          |                         |    |          |                         |    |          |                         |    |          |                         |    |          |                         |    |          |                         |    |          |                         |    |          |                         |    |          |                         |    |          |                         |    |          |                         |    |          |                         |    |          |                         |    |          |                         |    |          |                         |    |          |                         |    |          |                         |    |          |                         |    |          |                         |    |          |                         |    |          |                         |    |          |                         |    |          |                         |    |          |                         |    |          |                         |    |          |                         |    |          |                         |    |          |                         |    |          |                         |    |          |                         |    |          |                         |    |          |                         |    |          |                         |    |          |                         |    |          |                         |    |          |                         |    |          |                         |     |          |                         |  |  |   |
| 61  | 02/12/21   | REVISED AS PER COMMENTS  |  |   |          |                         |   |          |                         |   |          |                         |   |          |                         |   |          |                         |   |          |                         |   |          |                         |   |          |                         |   |          |                         |    |          |                         |    |          |                         |    |          |                         |    |          |                         |    |          |                         |    |          |                         |    |          |                         |    |          |                         |    |          |                         |    |          |                         |    |          |                         |    |          |                         |    |          |                         |    |          |                         |    |          |                         |    |          |                         |    |          |                         |    |          |                         |    |          |                         |    |          |                         |    |          |                         |    |          |                         |    |          |                         |    |          |                         |    |          |                         |    |          |                         |    |          |                         |    |          |                         |    |          |                         |    |          |                         |    |          |                         |    |          |                         |    |          |                         |    |          |                         |    |          |                         |    |          |                         |    |          |                         |    |          |                         |    |          |                         |    |          |                         |    |          |                         |    |          |                         |    |          |                         |    |          |                         |    |          |                         |    |          |                         |    |          |                         |    |          |                         |    |          |                         |    |          |                         |    |          |                         |    |          |                         |    |          |                         |    |          |                         |    |          |                         |    |          |                         |    |          |                         |    |          |                         |    |          |                         |    |          |                         |    |          |                         |    |          |                         |    |          |                         |    |          |                         |    |          |                         |    |          |                         |    |          |                         |    |          |                         |    |          |                         |    |          |                         |    |          |                         |    |          |                         |    |          |                         |    |          |                         |    |          |                         |    |          |                         |    |          |                         |    |          |                         |    |          |                         |    |          |                         |    |          |                         |    |          |                         |    |          |                         |    |          |                         |    |          |                         |    |          |                         |    |          |                         |    |          |                         |    |          |                         |    |          |                         |     |          |                         |  |  |   |
| 62  | 02/12/21   | REVISED AS PER COMMENTS  |  |   |          |                         |   |          |                         |   |          |                         |   |          |                         |   |          |                         |   |          |                         |   |          |                         |   |          |                         |   |          |                         |    |          |                         |    |          |                         |    |          |                         |    |          |                         |    |          |                         |    |          |                         |    |          |                         |    |          |                         |    |          |                         |    |          |                         |    |          |                         |    |          |                         |    |          |                         |    |          |                         |    |          |                         |    |          |                         |    |          |                         |    |          |                         |    |          |                         |    |          |                         |    |          |                         |    |          |                         |    |          |                         |    |          |                         |    |          |                         |    |          |                         |    |          |                         |    |          |                         |    |          |                         |    |          |                         |    |          |                         |    |          |                         |    |          |                         |    |          |                         |    |          |                         |    |          |                         |    |          |                         |    |          |                         |    |          |                         |    |          |                         |    |          |                         |    |          |                         |    |          |                         |    |          |                         |    |          |                         |    |          |                         |    |          |                         |    |          |                         |    |          |                         |    |          |                         |    |          |                         |    |          |                         |    |          |                         |    |          |                         |    |          |                         |    |          |                         |    |          |                         |    |          |                         |    |          |                         |    |          |                         |    |          |                         |    |          |                         |    |          |                         |    |          |                         |    |          |                         |    |          |                         |    |          |                         |    |          |                         |    |          |                         |    |          |                         |    |          |                         |    |          |                         |    |          |                         |    |          |                         |    |          |                         |    |          |                         |    |          |                         |    |          |                         |    |          |                         |    |          |                         |    |          |                         |    |          |                         |    |          |                         |    |          |                         |    |          |                         |    |          |                         |    |          |                         |    |          |                         |    |          |                         |    |          |                         |     |          |                         |  |  |   |
| 63  | 02/12/21   | REVISED AS PER COMMENTS  |  |   |          |                         |   |          |                         |   |          |                         |   |          |                         |   |          |                         |   |          |                         |   |          |                         |   |          |                         |   |          |                         |    |          |                         |    |          |                         |    |          |                         |    |          |                         |    |          |                         |    |          |                         |    |          |                         |    |          |                         |    |          |                         |    |          |                         |    |          |                         |    |          |                         |    |          |                         |    |          |                         |    |          |                         |    |          |                         |    |          |                         |    |          |                         |    |          |                         |    |          |                         |    |          |                         |    |          |                         |    |          |                         |    |          |                         |    |          |                         |    |          |                         |    |          |                         |    |          |                         |    |          |                         |    |          |                         |    |          |                         |    |          |                         |    |          |                         |    |          |                         |    |          |                         |    |          |                         |    |          |                         |    |          |                         |    |          |                         |    |          |                         |    |          |                         |    |          |                         |    |          |                         |    |          |                         |    |          |                         |    |          |                         |    |          |                         |    |          |                         |    |          |                         |    |          |                         |    |          |                         |    |          |                         |    |          |                         |    |          |                         |    |          |                         |    |          |                         |    |          |                         |    |          |                         |    |          |                         |    |          |                         |    |          |                         |    |          |                         |    |          |                         |    |          |                         |    |          |                         |    |          |                         |    |          |                         |    |          |                         |    |          |                         |    |          |                         |    |          |                         |    |          |                         |    |          |                         |    |          |                         |    |          |                         |    |          |                         |    |          |                         |    |          |                         |    |          |                         |    |          |                         |    |          |                         |    |          |                         |    |          |                         |    |          |                         |    |          |                         |    |          |                         |    |          |                         |    |          |                         |    |          |                         |    |          |                         |     |          |                         |  |  |   |
| 64  | 02/12/21   | REVISED AS PER COMMENTS  |  |   |          |                         |   |          |                         |   |          |                         |   |          |                         |   |          |                         |   |          |                         |   |          |                         |   |          |                         |   |          |                         |    |          |                         |    |          |                         |    |          |                         |    |          |                         |    |          |                         |    |          |                         |    |          |                         |    |          |                         |    |          |                         |    |          |                         |    |          |                         |    |          |                         |    |          |                         |    |          |                         |    |          |                         |    |          |                         |    |          |                         |    |          |                         |    |          |                         |    |          |                         |    |          |                         |    |          |                         |    |          |                         |    |          |                         |    |          |                         |    |          |                         |    |          |                         |    |          |                         |    |          |                         |    |          |                         |    |          |                         |    |          |                         |    |          |                         |    |          |                         |    |          |                         |    |          |                         |    |          |                         |    |          |                         |    |          |                         |    |          |                         |    |          |                         |    |          |                         |    |          |                         |    |          |                         |    |          |                         |    |          |                         |    |          |                         |    |          |                         |    |          |                         |    |          |                         |    |          |                         |    |          |                         |    |          |                         |    |          |                         |    |          |                         |    |          |                         |    |          |                         |    |          |                         |    |          |                         |    |          |                         |    |          |                         |    |          |                         |    |          |                         |    |          |                         |    |          |                         |    |          |                         |    |          |                         |    |          |                         |    |          |                         |    |          |                         |    |          |                         |    |          |                         |    |          |                         |    |          |                         |    |          |                         |    |          |                         |    |          |                         |    |          |                         |    |          |                         |    |          |                         |    |          |                         |    |          |                         |    |          |                         |    |          |                         |    |          |                         |    |          |                         |    |          |                         |    |          |                         |    |          |                         |    |          |                         |     |          |                         |  |  |   |
| 65  | 02/12/21   | REVISED AS PER COMMENTS  |  |   |          |                         |   |          |                         |   |          |                         |   |          |                         |   |          |                         |   |          |                         |   |          |                         |   |          |                         |   |          |                         |    |          |                         |    |          |                         |    |          |                         |    |          |                         |    |          |                         |    |          |                         |    |          |                         |    |          |                         |    |          |                         |    |          |                         |    |          |                         |    |          |                         |    |          |                         |    |          |                         |    |          |                         |    |          |                         |    |          |                         |    |          |                         |    |          |                         |    |          |                         |    |          |                         |    |          |                         |    |          |                         |    |          |                         |    |          |                         |    |          |                         |    |          |                         |    |          |                         |    |          |                         |    |          |                         |    |          |                         |    |          |                         |    |          |                         |    |          |                         |    |          |                         |    |          |                         |    |          |                         |    |          |                         |    |          |                         |    |          |                         |    |          |                         |    |          |                         |    |          |                         |    |          |                         |    |          |                         |    |          |                         |    |          |                         |    |          |                         |    |          |                         |    |          |                         |    |          |                         |    |          |                         |    |          |                         |    |          |                         |    |          |                         |    |          |                         |    |          |                         |    |          |                         |    |          |                         |    |          |                         |    |          |                         |    |          |                         |    |          |                         |    |          |                         |    |          |                         |    |          |                         |    |          |                         |    |          |                         |    |          |                         |    |          |                         |    |          |                         |    |          |                         |    |          |                         |    |          |                         |    |          |                         |    |          |                         |    |          |                         |    |          |                         |    |          |                         |    |          |                         |    |          |                         |    |          |                         |    |          |                         |    |          |                         |    |          |                         |    |          |                         |    |          |                         |    |          |                         |    |          |                         |    |          |                         |     |          |                         |  |  |   |
| 66  | 02/12/21   | REVISED AS PER COMMENTS  |  |   |          |                         |   |          |                         |   |          |                         |   |          |                         |   |          |                         |   |          |                         |   |          |                         |   |          |                         |   |          |                         |    |          |                         |    |          |                         |    |          |                         |    |          |                         |    |          |                         |    |          |                         |    |          |                         |    |          |                         |    |          |                         |    |          |                         |    |          |                         |    |          |                         |    |          |                         |    |          |                         |    |          |                         |    |          |                         |    |          |                         |    |          |                         |    |          |                         |    |          |                         |    |          |                         |    |          |                         |    |          |                         |    |          |                         |    |          |                         |    |          |                         |    |          |                         |    |          |                         |    |          |                         |    |          |                         |    |          |                         |    |          |                         |    |          |                         |    |          |                         |    |          |                         |    |          |                         |    |          |                         |    |          |                         |    |          |                         |    |          |                         |    |          |                         |    |          |                         |    |          |                         |    |          |                         |    |          |                         |    |          |                         |    |          |                         |    |          |                         |    |          |                         |    |          |                         |    |          |                         |    |          |                         |    |          |                         |    |          |                         |    |          |                         |    |          |                         |    |          |                         |    |          |                         |    |          |                         |    |          |                         |    |          |                         |    |          |                         |    |          |                         |    |          |                         |    |          |                         |    |          |                         |    |          |                         |    |          |                         |    |          |                         |    |          |                         |    |          |                         |    |          |                         |    |          |                         |    |          |                         |    |          |                         |    |          |                         |    |          |                         |    |          |                         |    |          |                         |    |          |                         |    |          |                         |    |          |                         |    |          |                         |    |          |                         |    |          |                         |    |          |                         |    |          |                         |    |          |                         |    |          |                         |    |          |                         |     |          |                         |  |  |   |
| 67  | 02/12/21   | REVISED AS PER COMMENTS  |  |   |          |                         |   |          |                         |   |          |                         |   |          |                         |   |          |                         |   |          |                         |   |          |                         |   |          |                         |   |          |                         |    |          |                         |    |          |                         |    |          |                         |    |          |                         |    |          |                         |    |          |                         |    |          |                         |    |          |                         |    |          |                         |    |          |                         |    |          |                         |    |          |                         |    |          |                         |    |          |                         |    |          |                         |    |          |                         |    |          |                         |    |          |                         |    |          |                         |    |          |                         |    |          |                         |    |          |                         |    |          |                         |    |          |                         |    |          |                         |    |          |                         |    |          |                         |    |          |                         |    |          |                         |    |          |                         |    |          |                         |    |          |                         |    |          |                         |    |          |                         |    |          |                         |    |          |                         |    |          |                         |    |          |                         |    |          |                         |    |          |                         |    |          |                         |    |          |                         |    |          |                         |    |          |                         |    |          |                         |    |          |                         |    |          |                         |    |          |                         |    |          |                         |    |          |                         |    |          |                         |    |          |                         |    |          |                         |    |          |                         |    |          |                         |    |          |                         |    |          |                         |    |          |                         |    |          |                         |    |          |                         |    |          |                         |    |          |                         |    |          |                         |    |          |                         |    |          |                         |    |          |                         |    |          |                         |    |          |                         |    |          |                         |    |          |                         |    |          |                         |    |          |                         |    |          |                         |    |          |                         |    |          |                         |    |          |                         |    |          |                         |    |          |                         |    |          |                         |    |          |                         |    |          |                         |    |          |                         |    |          |                         |    |          |                         |    |          |                         |    |          |                         |    |          |                         |    |          |                         |    |          |                         |    |          |                         |     |          |                         |  |  |   |
| 68  | 02/12/21   | REVISED AS PER COMMENTS  |  |   |          |                         |   |          |                         |   |          |                         |   |          |                         |   |          |                         |   |          |                         |   |          |                         |   |          |                         |   |          |                         |    |          |                         |    |          |                         |    |          |                         |    |          |                         |    |          |                         |    |          |                         |    |          |                         |    |          |                         |    |          |                         |    |          |                         |    |          |                         |    |          |                         |    |          |                         |    |          |                         |    |          |                         |    |          |                         |    |          |                         |    |          |                         |    |          |                         |    |          |                         |    |          |                         |    |          |                         |    |          |                         |    |          |                         |    |          |                         |    |          |                         |    |          |                         |    |          |                         |    |          |                         |    |          |                         |    |          |                         |    |          |                         |    |          |                         |    |          |                         |    |          |                         |    |          |                         |    |          |                         |    |          |                         |    |          |                         |    |          |                         |    |          |                         |    |          |                         |    |          |                         |    |          |                         |    |          |                         |    |          |                         |    |          |                         |    |          |                         |    |          |                         |    |          |                         |    |          |                         |    |          |                         |    |          |                         |    |          |                         |    |          |                         |    |          |                         |    |          |                         |    |          |                         |    |          |                         |    |          |                         |    |          |                         |    |          |                         |    |          |                         |    |          |                         |    |          |                         |    |          |                         |    |          |                         |    |          |                         |    |          |                         |    |          |                         |    |          |                         |    |          |                         |    |          |                         |    |          |                         |    |          |                         |    |          |                         |    |          |                         |    |          |                         |    |          |                         |    |          |                         |    |          |                         |    |          |                         |    |          |                         |    |          |                         |    |          |                         |    |          |                         |    |          |                         |    |          |                         |    |          |                         |    |          |                         |     |          |                         |  |  |   |
| 69  | 02/12/21   | REVISED AS PER COMMENTS  |  |   |          |                         |   |          |                         |   |          |                         |   |          |                         |   |          |                         |   |          |                         |   |          |                         |   |          |                         |   |          |                         |    |          |                         |    |          |                         |    |          |                         |    |          |                         |    |          |                         |    |          |                         |    |          |                         |    |          |                         |    |          |                         |    |          |                         |    |          |                         |    |          |                         |    |          |                         |    |          |                         |    |          |                         |    |          |                         |    |          |                         |    |          |                         |    |          |                         |    |          |                         |    |          |                         |    |          |                         |    |          |                         |    |          |                         |    |          |                         |    |          |                         |    |          |                         |    |          |                         |    |          |                         |    |          |                         |    |          |                         |    |          |                         |    |          |                         |    |          |                         |    |          |                         |    |          |                         |    |          |                         |    |          |                         |    |          |                         |    |          |                         |    |          |                         |    |          |                         |    |          |                         |    |          |                         |    |          |                         |    |          |                         |    |          |                         |    |          |                         |    |          |                         |    |          |                         |    |          |                         |    |          |                         |    |          |                         |    |          |                         |    |          |                         |    |          |                         |    |          |                         |    |          |                         |    |          |                         |    |          |                         |    |          |                         |    |          |                         |    |          |                         |    |          |                         |    |          |                         |    |          |                         |    |          |                         |    |          |                         |    |          |                         |    |          |                         |    |          |                         |    |          |                         |    |          |                         |    |          |                         |    |          |                         |    |          |                         |    |          |                         |    |          |                         |    |          |                         |    |          |                         |    |          |                         |    |          |                         |    |          |                         |    |          |                         |    |          |                         |    |          |                         |    |          |                         |    |          |                         |    |          |                         |    |          |                         |     |          |                         |  |  |   |
| 70  | 02/12/21   | REVISED AS PER COMMENTS  |  |   |          |                         |   |          |                         |   |          |                         |   |          |                         |   |          |                         |   |          |                         |   |          |                         |   |          |                         |   |          |                         |    |          |                         |    |          |                         |    |          |                         |    |          |                         |    |          |                         |    |          |                         |    |          |                         |    |          |                         |    |          |                         |    |          |                         |    |          |                         |    |          |                         |    |          |                         |    |          |                         |    |          |                         |    |          |                         |    |          |                         |    |          |                         |    |          |                         |    |          |                         |    |          |                         |    |          |                         |    |          |                         |    |          |                         |    |          |                         |    |          |                         |    |          |                         |    |          |                         |    |          |                         |    |          |                         |    |          |                         |    |          |                         |    |          |                         |    |          |                         |    |          |                         |    |          |                         |    |          |                         |    |          |                         |    |          |                         |    |          |                         |    |          |                         |    |          |                         |    |          |                         |    |          |                         |    |          |                         |    |          |                         |    |          |                         |    |          |                         |    |          |                         |    |          |                         |    |          |                         |    |          |                         |    |          |                         |    |          |                         |    |          |                         |    |          |                         |    |          |                         |    |          |                         |    |          |                         |    |          |                         |    |          |                         |    |          |                         |    |          |                         |    |          |                         |    |          |                         |    |          |                         |    |          |                         |    |          |                         |    |          |                         |    |          |                         |    |          |                         |    |          |                         |    |          |                         |    |          |                         |    |          |                         |    |          |                         |    |          |                         |    |          |                         |    |          |                         |    |          |                         |    |          |                         |    |          |                         |    |          |                         |    |          |                         |    |          |                         |    |          |                         |    |          |                         |    |          |                         |    |          |                         |    |          |                         |     |          |                         |  |  |   |
| 71  | 02/12/21   | REVISED AS PER COMMENTS  |  |   |          |                         |   |          |                         |   |          |                         |   |          |                         |   |          |                         |   |          |                         |   |          |                         |   |          |                         |   |          |                         |    |          |                         |    |          |                         |    |          |                         |    |          |                         |    |          |                         |    |          |                         |    |          |                         |    |          |                         |    |          |                         |    |          |                         |    |          |                         |    |          |                         |    |          |                         |    |          |                         |    |          |                         |    |          |                         |    |          |                         |    |          |                         |    |          |                         |    |          |                         |    |          |                         |    |          |                         |    |          |                         |    |          |                         |    |          |                         |    |          |                         |    |          |                         |    |          |                         |    |          |                         |    |          |                         |    |          |                         |    |          |                         |    |          |                         |    |          |                         |    |          |                         |    |          |                         |    |          |                         |    |          |                         |    |          |                         |    |          |                         |    |          |                         |    |          |                         |    |          |                         |    |          |                         |    |          |                         |    |          |                         |    |          |                         |    |          |                         |    |          |                         |    |          |                         |    |          |                         |    |          |                         |    |          |                         |    |          |                         |    |          |                         |    |          |                         |    |          |                         |    |          |                         |    |          |                         |    |          |                         |    |          |                         |    |          |                         |    |          |                         |    |          |                         |    |          |                         |    |          |                         |    |          |                         |    |          |                         |    |          |                         |    |          |                         |    |          |                         |    |          |                         |    |          |                         |    |          |                         |    |          |                         |    |          |                         |    |          |                         |    |          |                         |    |          |                         |    |          |                         |    |          |                         |    |          |                         |    |          |                         |    |          |                         |    |          |                         |    |          |                         |    |          |                         |    |          |                         |    |          |                         |    |          |                         |     |          |                         |  |  |   |
| 72  | 02/12/21   | REVISED AS PER COMMENTS  |  |   |          |                         |   |          |                         |   |          |                         |   |          |                         |   |          |                         |   |          |                         |   |          |                         |   |          |                         |   |          |                         |    |          |                         |    |          |                         |    |          |                         |    |          |                         |    |          |                         |    |          |                         |    |          |                         |    |          |                         |    |          |                         |    |          |                         |    |          |                         |    |          |                         |    |          |                         |    |          |                         |    |          |                         |    |          |                         |    |          |                         |    |          |                         |    |          |                         |    |          |                         |    |          |                         |    |          |                         |    |          |                         |    |          |                         |    |          |                         |    |          |                         |    |          |                         |    |          |                         |    |          |                         |    |          |                         |    |          |                         |    |          |                         |    |          |                         |    |          |                         |    |          |                         |    |          |                         |    |          |                         |    |          |                         |    |          |                         |    |          |                         |    |          |                         |    |          |                         |    |          |                         |    |          |                         |    |          |                         |    |          |                         |    |          |                         |    |          |                         |    |          |                         |    |          |                         |    |          |                         |    |          |                         |    |          |                         |    |          |                         |    |          |                         |    |          |                         |    |          |                         |    |          |                         |    |          |                         |    |          |                         |    |          |                         |    |          |                         |    |          |                         |    |          |                         |    |          |                         |    |          |                         |    |          |                         |    |          |                         |    |          |                         |    |          |                         |    |          |                         |    |          |                         |    |          |                         |    |          |                         |    |          |                         |    |          |                         |    |          |                         |    |          |                         |    |          |                         |    |          |                         |    |          |                         |    |          |                         |    |          |                         |    |          |                         |    |          |                         |    |          |                         |    |          |                         |    |          |                         |    |          |                         |    |          |                         |     |          |                         |  |  |   |
| 73  | 02/12/21   | REVISED AS PER COMMENTS  |  |   |          |                         |   |          |                         |   |          |                         |   |          |                         |   |          |                         |   |          |                         |   |          |                         |   |          |                         |   |          |                         |    |          |                         |    |          |                         |    |          |                         |    |          |                         |    |          |                         |    |          |                         |    |          |                         |    |          |                         |    |          |                         |    |          |                         |    |          |                         |    |          |                         |    |          |                         |    |          |                         |    |          |                         |    |          |                         |    |          |                         |    |          |                         |    |          |                         |    |          |                         |    |          |                         |    |          |                         |    |          |                         |    |          |                         |    |          |                         |    |          |                         |    |          |                         |    |          |                         |    |          |                         |    |          |                         |    |          |                         |    |          |                         |    |          |                         |    |          |                         |    |          |                         |    |          |                         |    |          |                         |    |          |                         |    |          |                         |    |          |                         |    |          |                         |    |          |                         |    |          |                         |    |          |                         |    |          |                         |    |          |                         |    |          |                         |    |          |                         |    |          |                         |    |          |                         |    |          |                         |    |          |                         |    |          |                         |    |          |                         |    |          |                         |    |          |                         |    |          |                         |    |          |                         |    |          |                         |    |          |                         |    |          |                         |    |          |                         |    |          |                         |    |          |                         |    |          |                         |    |          |                         |    |          |                         |    |          |                         |    |          |                         |    |          |                         |    |          |                         |    |          |                         |    |          |                         |    |          |                         |    |          |                         |    |          |                         |    |          |                         |    |          |                         |    |          |                         |    |          |                         |    |          |                         |    |          |                         |    |          |                         |    |          |                         |    |          |                         |    |          |                         |    |          |                         |    |          |                         |    |          |                         |    |          |                         |     |          |                         |  |  |   |
| 74  | 02/12/21   | REVISED AS PER COMMENTS  |  |   |          |                         |   |          |                         |   |          |                         |   |          |                         |   |          |                         |   |          |                         |   |          |                         |   |          |                         |   |          |                         |    |          |                         |    |          |                         |    |          |                         |    |          |                         |    |          |                         |    |          |                         |    |          |                         |    |          |                         |    |          |                         |    |          |                         |    |          |                         |    |          |                         |    |          |                         |    |          |                         |    |          |                         |    |          |                         |    |          |                         |    |          |                         |    |          |                         |    |          |                         |    |          |                         |    |          |                         |    |          |                         |    |          |                         |    |          |                         |    |          |                         |    |          |                         |    |          |                         |    |          |                         |    |          |                         |    |          |                         |    |          |                         |    |          |                         |    |          |                         |    |          |                         |    |          |                         |    |          |                         |    |          |                         |    |          |                         |    |          |                         |    |          |                         |    |          |                         |    |          |                         |    |          |                         |    |          |                         |    |          |                         |    |          |                         |    |          |                         |    |          |                         |    |          |                         |    |          |                         |    |          |                         |    |          |                         |    |          |                         |    |          |                         |    |          |                         |    |          |                         |    |          |                         |    |          |                         |    |          |                         |    |          |                         |    |          |                         |    |          |                         |    |          |                         |    |          |                         |    |          |                         |    |          |                         |    |          |                         |    |          |                         |    |          |                         |    |          |                         |    |          |                         |    |          |                         |    |          |                         |    |          |                         |    |          |                         |    |          |                         |    |          |                         |    |          |                         |    |          |                         |    |          |                         |    |          |                         |    |          |                         |    |          |                         |    |          |                         |    |          |                         |    |          |                         |    |          |                         |    |          |                         |    |          |                         |     |          |                         |  |  |   |
| 75  | 02/12/21   | REVISED AS PER COMMENTS  |  |   |          |                         |   |          |                         |   |          |                         |   |          |                         |   |          |                         |   |          |                         |   |          |                         |   |          |                         |   |          |                         |    |          |                         |    |          |                         |    |          |                         |    |          |                         |    |          |                         |    |          |                         |    |          |                         |    |          |                         |    |          |                         |    |          |                         |    |          |                         |    |          |                         |    |          |                         |    |          |                         |    |          |                         |    |          |                         |    |          |                         |    |          |                         |    |          |                         |    |          |                         |    |          |                         |    |          |                         |    |          |                         |    |          |                         |    |          |                         |    |          |                         |    |          |                         |    |          |                         |    |          |                         |    |          |                         |    |          |                         |    |          |                         |    |          |                         |    |          |                         |    |          |                         |    |          |                         |    |          |                         |    |          |                         |    |          |                         |    |          |                         |    |          |                         |    |          |                         |    |          |                         |    |          |                         |    |          |                         |    |          |                         |    |          |                         |    |          |                         |    |          |                         |    |          |                         |    |          |                         |    |          |                         |    |          |                         |    |          |                         |    |          |                         |    |          |                         |    |          |                         |    |          |                         |    |          |                         |    |          |                         |    |          |                         |    |          |                         |    |          |                         |    |          |                         |    |          |                         |    |          |                         |    |          |                         |    |          |                         |    |          |                         |    |          |                         |    |          |                         |    |          |                         |    |          |                         |    |          |                         |    |          |                         |    |          |                         |    |          |                         |    |          |                         |    |          |                         |    |          |                         |    |          |                         |    |          |                         |    |          |                         |    |          |                         |    |          |                         |    |          |                         |    |          |                         |    |          |                         |    |          |                         |    |          |                         |     |          |                         |  |  |   |
| 76  | 02/12/21   | REVISED AS PER COMMENTS  |  |   |          |                         |   |          |                         |   |          |                         |   |          |                         |   |          |                         |   |          |                         |   |          |                         |   |          |                         |   |          |                         |    |          |                         |    |          |                         |    |          |                         |    |          |                         |    |          |                         |    |          |                         |    |          |                         |    |          |                         |    |          |                         |    |          |                         |    |          |                         |    |          |                         |    |          |                         |    |          |                         |    |          |                         |    |          |                         |    |          |                         |    |          |                         |    |          |                         |    |          |                         |    |          |                         |    |          |                         |    |          |                         |    |          |                         |    |          |                         |    |          |                         |    |          |                         |    |          |                         |    |          |                         |    |          |                         |    |          |                         |    |          |                         |    |          |                         |    |          |                         |    |          |                         |    |          |                         |    |          |                         |    |          |                         |    |          |                         |    |          |                         |    |          |                         |    |          |                         |    |          |                         |    |          |                         |    |          |                         |    |          |                         |    |          |                         |    |          |                         |    |          |                         |    |          |                         |    |          |                         |    |          |                         |    |          |                         |    |          |                         |    |          |                         |    |          |                         |    |          |                         |    |          |                         |    |          |                         |    |          |                         |    |          |                         |    |          |                         |    |          |                         |    |          |                         |    |          |                         |    |          |                         |    |          |                         |    |          |                         |    |          |                         |    |          |                         |    |          |                         |    |          |                         |    |          |                         |    |          |                         |    |          |                         |    |          |                         |    |          |                         |    |          |                         |    |          |                         |    |          |                         |    |          |                         |    |          |                         |    |          |                         |    |          |                         |    |          |                         |    |          |                         |    |          |                         |    |          |                         |    |          |                         |    |          |                         |     |          |                         |  |  |   |
| 77  | 02/12/21   | REVISED AS PER COMMENTS  |  |   |          |                         |   |          |                         |   |          |                         |   |          |                         |   |          |                         |   |          |                         |   |          |                         |   |          |                         |   |          |                         |    |          |                         |    |          |                         |    |          |                         |    |          |                         |    |          |                         |    |          |                         |    |          |                         |    |          |                         |    |          |                         |    |          |                         |    |          |                         |    |          |                         |    |          |                         |    |          |                         |    |          |                         |    |          |                         |    |          |                         |    |          |                         |    |          |                         |    |          |                         |    |          |                         |    |          |                         |    |          |                         |    |          |                         |    |          |                         |    |          |                         |    |          |                         |    |          |                         |    |          |                         |    |          |                         |    |          |                         |    |          |                         |    |          |                         |    |          |                         |    |          |                         |    |          |                         |    |          |                         |    |          |                         |    |          |                         |    |          |                         |    |          |                         |    |          |                         |    |          |                         |    |          |                         |    |          |                         |    |          |                         |    |          |                         |    |          |                         |    |          |                         |    |          |                         |    |          |                         |    |          |                         |    |          |                         |    |          |                         |    |          |                         |    |          |                         |    |          |                         |    |          |                         |    |          |                         |    |          |                         |    |          |                         |    |          |                         |    |          |                         |    |          |                         |    |          |                         |    |          |                         |    |          |                         |    |          |                         |    |          |                         |    |          |                         |    |          |                         |    |          |                         |    |          |                         |    |          |                         |    |          |                         |    |          |                         |    |          |                         |    |          |                         |    |          |                         |    |          |                         |    |          |                         |    |          |                         |    |          |                         |    |          |                         |    |          |                         |    |          |                         |    |          |                         |    |          |                         |    |          |                         |    |          |                         |     |          |                         |  |  |   |
| 78  | 02/12/21   | REVISED AS PER COMMENTS  |  |   |          |                         |   |          |                         |   |          |                         |   |          |                         |   |          |                         |   |          |                         |   |          |                         |   |          |                         |   |          |                         |    |          |                         |    |          |                         |    |          |                         |    |          |                         |    |          |                         |    |          |                         |    |          |                         |    |          |                         |    |          |                         |    |          |                         |    |          |                         |    |          |                         |    |          |                         |    |          |                         |    |          |                         |    |          |                         |    |          |                         |    |          |                         |    |          |                         |    |          |                         |    |          |                         |    |          |                         |    |          |                         |    |          |                         |    |          |                         |    |          |                         |    |          |                         |    |          |                         |    |          |                         |    |          |                         |    |          |                         |    |          |                         |    |          |                         |    |          |                         |    |          |                         |    |          |                         |    |          |                         |    |          |                         |    |          |                         |    |          |                         |    |          |                         |    |          |                         |    |          |                         |    |          |                         |    |          |                         |    |          |                         |    |          |                         |    |          |                         |    |          |                         |    |          |                         |    |          |                         |    |          |                         |    |          |                         |    |          |                         |    |          |                         |    |          |                         |    |          |                         |    |          |                         |    |          |                         |    |          |                         |    |          |                         |    |          |                         |    |          |                         |    |          |                         |    |          |                         |    |          |                         |    |          |                         |    |          |                         |    |          |                         |    |          |                         |    |          |                         |    |          |                         |    |          |                         |    |          |                         |    |          |                         |    |          |                         |    |          |                         |    |          |                         |    |          |                         |    |          |                         |    |          |                         |    |          |                         |    |          |                         |    |          |                         |    |          |                         |    |          |                         |    |          |                         |    |          |                         |    |          |                         |    |          |                         |     |          |                         |  |  |   |
| 79  | 02/12/21   | REVISED AS PER COMMENTS  |  |   |          |                         |   |          |                         |   |          |                         |   |          |                         |   |          |                         |   |          |                         |   |          |                         |   |          |                         |   |          |                         |    |          |                         |    |          |                         |    |          |                         |    |          |                         |    |          |                         |    |          |                         |    |          |                         |    |          |                         |    |          |                         |    |          |                         |    |          |                         |    |          |                         |    |          |                         |    |          |                         |    |          |                         |    |          |                         |    |          |                         |    |          |                         |    |          |                         |    |          |                         |    |          |                         |    |          |                         |    |          |                         |    |          |                         |    |          |                         |    |          |                         |    |          |                         |    |          |                         |    |          |                         |    |          |                         |    |          |                         |    |          |                         |    |          |                         |    |          |                         |    |          |                         |    |          |                         |    |          |                         |    |          |                         |    |          |                         |    |          |                         |    |          |                         |    |          |                         |    |          |                         |    |          |                         |    |          |                         |    |          |                         |    |          |                         |    |          |                         |    |          |                         |    |          |                         |    |          |                         |    |          |                         |    |          |                         |    |          |                         |    |          |                         |    |          |                         |    |          |                         |    |          |                         |    |          |                         |    |          |                         |    |          |                         |    |          |                         |    |          |                         |    |          |                         |    |          |                         |    |          |                         |    |          |                         |    |          |                         |    |          |                         |    |          |                         |    |          |                         |    |          |                         |    |          |                         |    |          |                         |    |          |                         |    |          |                         |    |          |                         |    |          |                         |    |          |                         |    |          |                         |    |          |                         |    |          |                         |    |          |                         |    |          |                         |    |          |                         |    |          |                         |    |          |                         |    |          |                         |    |          |                         |    |          |                         |     |          |                         |  |  |   |
| 80  | 02/12/21   | REVISED AS PER COMMENTS  |  |   |          |                         |   |          |                         |   |          |                         |   |          |                         |   |          |                         |   |          |                         |   |          |                         |   |          |                         |   |          |                         |    |          |                         |    |          |                         |    |          |                         |    |          |                         |    |          |                         |    |          |                         |    |          |                         |    |          |                         |    |          |                         |    |          |                         |    |          |                         |    |          |                         |    |          |                         |    |          |                         |    |          |                         |    |          |                         |    |          |                         |    |          |                         |    |          |                         |    |          |                         |    |          |                         |    |          |                         |    |          |                         |    |          |                         |    |          |                         |    |          |                         |    |          |                         |    |          |                         |    |          |                         |    |          |                         |    |          |                         |    |          |                         |    |          |                         |    |          |                         |    |          |                         |    |          |                         |    |          |                         |    |          |                         |    |          |                         |    |          |                         |    |          |                         |    |          |                         |    |          |                         |    |          |                         |    |          |                         |    |          |                         |    |          |                         |    |          |                         |    |          |                         |    |          |                         |    |          |                         |    |          |                         |    |          |                         |    |          |                         |    |          |                         |    |          |                         |    |          |                         |    |          |                         |    |          |                         |    |          |                         |    |          |                         |    |          |                         |    |          |                         |    |          |                         |    |          |                         |    |          |                         |    |          |                         |    |          |                         |    |          |                         |    |          |                         |    |          |                         |    |          |                         |    |          |                         |    |          |                         |    |          |                         |    |          |                         |    |          |                         |    |          |                         |    |          |                         |    |          |                         |    |          |                         |    |          |                         |    |          |                         |    |          |                         |    |          |                         |    |          |                         |    |          |                         |    |          |                         |    |          |                         |    |          |                         |     |          |                         |  |  |   |
| 81  | 02/12/21   | REVISED AS PER COMMENTS  |  |   |          |                         |   |          |                         |   |          |                         |   |          |                         |   |          |                         |   |          |                         |   |          |                         |   |          |                         |   |          |                         |    |          |                         |    |          |                         |    |          |                         |    |          |                         |    |          |                         |    |          |                         |    |          |                         |    |          |                         |    |          |                         |    |          |                         |    |          |                         |    |          |                         |    |          |                         |    |          |                         |    |          |                         |    |          |                         |    |          |                         |    |          |                         |    |          |                         |    |          |                         |    |          |                         |    |          |                         |    |          |                         |    |          |                         |    |          |                         |    |          |                         |    |          |                         |    |          |                         |    |          |                         |    |          |                         |    |          |                         |    |          |                         |    |          |                         |    |          |                         |    |          |                         |    |          |                         |    |          |                         |    |          |                         |    |          |                         |    |          |                         |    |          |                         |    |          |                         |    |          |                         |    |          |                         |    |          |                         |    |          |                         |    |          |                         |    |          |                         |    |          |                         |    |          |                         |    |          |                         |    |          |                         |    |          |                         |    |          |                         |    |          |                         |    |          |                         |    |          |                         |    |          |                         |    |          |                         |    |          |                         |    |          |                         |    |          |                         |    |          |                         |    |          |                         |    |          |                         |    |          |                         |    |          |                         |    |          |                         |    |          |                         |    |          |                         |    |          |                         |    |          |                         |    |          |                         |    |          |                         |    |          |                         |    |          |                         |    |          |                         |    |          |                         |    |          |                         |    |          |                         |    |          |                         |    |          |                         |    |          |                         |    |          |                         |    |          |                         |    |          |                         |    |          |                         |    |          |                         |    |          |                         |    |          |                         |     |          |                         |  |  |   |
| 82  | 02/12/21   | REVISED AS PER COMMENTS  |  |   |          |                         |   |          |                         |   |          |                         |   |          |                         |   |          |                         |   |          |                         |   |          |                         |   |          |                         |   |          |                         |    |          |                         |    |          |                         |    |          |                         |    |          |                         |    |          |                         |    |          |                         |    |          |                         |    |          |                         |    |          |                         |    |          |                         |    |          |                         |    |          |                         |    |          |                         |    |          |                         |    |          |                         |    |          |                         |    |          |                         |    |          |                         |    |          |                         |    |          |                         |    |          |                         |    |          |                         |    |          |                         |    |          |                         |    |          |                         |    |          |                         |    |          |                         |    |          |                         |    |          |                         |    |          |                         |    |          |                         |    |          |                         |    |          |                         |    |          |                         |    |          |                         |    |          |                         |    |          |                         |    |          |                         |    |          |                         |    |          |                         |    |          |                         |    |          |                         |    |          |                         |    |          |                         |    |          |                         |    |          |                         |    |          |                         |    |          |                         |    |          |                         |    |          |                         |    |          |                         |    |          |                         |    |          |                         |    |          |                         |    |          |                         |    |          |                         |    |          |                         |    |          |                         |    |          |                         |    |          |                         |    |          |                         |    |          |                         |    |          |                         |    |          |                         |    |          |                         |    |          |                         |    |          |                         |    |          |                         |    |          |                         |    |          |                         |    |          |                         |    |          |                         |    |          |                         |    |          |                         |    |          |                         |    |          |                         |    |          |                         |    |          |                         |    |          |                         |    |          |                         |    |          |                         |    |          |                         |    |          |                         |    |          |                         |    |          |                         |    |          |                         |    |          |                         |    |          |                         |    |          |                         |    |          |                         |     |          |                         |  |  |   |
| 83  | 02/12/21   | REVISED AS PER COMMENTS  |  |   |          |                         |   |          |                         |   |          |                         |   |          |                         |   |          |                         |   |          |                         |   |          |                         |   |          |                         |   |          |                         |    |          |                         |    |          |                         |    |          |                         |    |          |                         |    |          |                         |    |          |                         |    |          |                         |    |          |                         |    |          |                         |    |          |                         |    |          |                         |    |          |                         |    |          |                         |    |          |                         |    |          |                         |    |          |                         |    |          |                         |    |          |                         |    |          |                         |    |          |                         |    |          |                         |    |          |                         |    |          |                         |    |          |                         |    |          |                         |    |          |                         |    |          |                         |    |          |                         |    |          |                         |    |          |                         |    |          |                         |    |          |                         |    |          |                         |    |          |                         |    |          |                         |    |          |                         |    |          |                         |    |          |                         |    |          |                         |    |          |                         |    |          |                         |    |          |                         |    |          |                         |    |          |                         |    |          |                         |    |          |                         |    |          |                         |    |          |                         |    |          |                         |    |          |                         |    |          |                         |    |          |                         |    |          |                         |    |          |                         |    |          |                         |    |          |                         |    |          |                         |    |          |                         |    |          |                         |    |          |                         |    |          |                         |    |          |                         |    |          |                         |    |          |                         |    |          |                         |    |          |                         |    |          |                         |    |          |                         |    |          |                         |    |          |                         |    |          |                         |    |          |                         |    |          |                         |    |          |                         |    |          |                         |    |          |                         |    |          |                         |    |          |                         |    |          |                         |    |          |                         |    |          |                         |    |          |                         |    |          |                         |    |          |                         |    |          |                         |    |          |                         |    |          |                         |    |          |                         |    |          |                         |    |          |                         |     |          |                         |  |  |   |
| 84  | 02/12/21   | REVISED AS PER COMMENTS  |  |   |          |                         |   |          |                         |   |          |                         |   |          |                         |   |          |                         |   |          |                         |   |          |                         |   |          |                         |   |          |                         |    |          |                         |    |          |                         |    |          |                         |    |          |                         |    |          |                         |    |          |                         |    |          |                         |    |          |                         |    |          |                         |    |          |                         |    |          |                         |    |          |                         |    |          |                         |    |          |                         |    |          |                         |    |          |                         |    |          |                         |    |          |                         |    |          |                         |    |          |                         |    |          |                         |    |          |                         |    |          |                         |    |          |                         |    |          |                         |    |          |                         |    |          |                         |    |          |                         |    |          |                         |    |          |                         |    |          |                         |    |          |                         |    |          |                         |    |          |                         |    |          |                         |    |          |                         |    |          |                         |    |          |                         |    |          |                         |    |          |                         |    |          |                         |    |          |                         |    |          |                         |    |          |                         |    |          |                         |    |          |                         |    |          |                         |    |          |                         |    |          |                         |    |          |                         |    |          |                         |    |          |                         |    |          |                         |    |          |                         |    |          |                         |    |          |                         |    |          |                         |    |          |                         |    |          |                         |    |          |                         |    |          |                         |    |          |                         |    |          |                         |    |          |                         |    |          |                         |    |          |                         |    |          |                         |    |          |                         |    |          |                         |    |          |                         |    |          |                         |    |          |                         |    |          |                         |    |          |                         |    |          |                         |    |          |                         |    |          |                         |    |          |                         |    |          |                         |    |          |                         |    |          |                         |    |          |                         |    |          |                         |    |          |                         |    |          |                         |    |          |                         |    |          |                         |    |          |                         |    |          |                         |    |          |                         |     |          |                         |  |  |   |
| 85  | 02/12/21   | REVISED AS PER COMMENTS  |  |   |          |                         |   |          |                         |   |          |                         |   |          |                         |   |          |                         |   |          |                         |   |          |                         |   |          |                         |   |          |                         |    |          |                         |    |          |                         |    |          |                         |    |          |                         |    |          |                         |    |          |                         |    |          |                         |    |          |                         |    |          |                         |    |          |                         |    |          |                         |    |          |                         |    |          |                         |    |          |                         |    |          |                         |    |          |                         |    |          |                         |    |          |                         |    |          |                         |    |          |                         |    |          |                         |    |          |                         |    |          |                         |    |          |                         |    |          |                         |    |          |                         |    |          |                         |    |          |                         |    |          |                         |    |          |                         |    |          |                         |    |          |                         |    |          |                         |    |          |                         |    |          |                         |    |          |                         |    |          |                         |    |          |                         |    |          |                         |    |          |                         |    |          |                         |    |          |                         |    |          |                         |    |          |                         |    |          |                         |    |          |                         |    |          |                         |    |          |                         |    |          |                         |    |          |                         |    |          |                         |    |          |                         |    |          |                         |    |          |                         |    |          |                         |    |          |                         |    |          |                         |    |          |                         |    |          |                         |    |          |                         |    |          |                         |    |          |                         |    |          |                         |    |          |                         |    |          |                         |    |          |                         |    |          |                         |    |          |                         |    |          |                         |    |          |                         |    |          |                         |    |          |                         |    |          |                         |    |          |                         |    |          |                         |    |          |                         |    |          |                         |    |          |                         |    |          |                         |    |          |                         |    |          |                         |    |          |                         |    |          |                         |    |          |                         |    |          |                         |    |          |                         |    |          |                         |    |          |                         |    |          |                         |    |          |                         |     |          |                         |  |  |   |
| 86  | 02/12/21   | REVISED AS PER COMMENTS  |  |   |          |                         |   |          |                         |   |          |                         |   |          |                         |   |          |                         |   |          |                         |   |          |                         |   |          |                         |   |          |                         |    |          |                         |    |          |                         |    |          |                         |    |          |                         |    |          |                         |    |          |                         |    |          |                         |    |          |                         |    |          |                         |    |          |                         |    |          |                         |    |          |                         |    |          |                         |    |          |                         |    |          |                         |    |          |                         |    |          |                         |    |          |                         |    |          |                         |    |          |                         |    |          |                         |    |          |                         |    |          |                         |    |          |                         |    |          |                         |    |          |                         |    |          |                         |    |          |                         |    |          |                         |    |          |                         |    |          |                         |    |          |                         |    |          |                         |    |          |                         |    |          |                         |    |          |                         |    |          |                         |    |          |                         |    |          |                         |    |          |                         |    |          |                         |    |          |                         |    |          |                         |    |          |                         |    |          |                         |    |          |                         |    |          |                         |    |          |                         |    |          |                         |    |          |                         |    |          |                         |    |          |                         |    |          |                         |    |          |                         |    |          |                         |    |          |                         |    |          |                         |    |          |                         |    |          |                         |    |          |                         |    |          |                         |    |          |                         |    |          |                         |    |          |                         |    |          |                         |    |          |                         |    |          |                         |    |          |                         |    |          |                         |    |          |                         |    |          |                         |    |          |                         |    |          |                         |    |          |                         |    |          |                         |    |          |                         |    |          |                         |    |          |                         |    |          |                         |    |          |                         |    |          |                         |    |          |                         |    |          |                         |    |          |                         |    |          |                         |    |          |                         |    |          |                         |    |          |                         |    |          |                         |    |          |                         |     |          |                         |  |  |   |
| 87  | 02/12/21   | REVISED AS PER COMMENTS  |  |   |          |                         |   |          |                         |   |          |                         |   |          |                         |   |          |                         |   |          |                         |   |          |                         |   |          |                         |   |          |                         |    |          |                         |    |          |                         |    |          |                         |    |          |                         |    |          |                         |    |          |                         |    |          |                         |    |          |                         |    |          |                         |    |          |                         |    |          |                         |    |          |                         |    |          |                         |    |          |                         |    |          |                         |    |          |                         |    |          |                         |    |          |                         |    |          |                         |    |          |                         |    |          |                         |    |          |                         |    |          |                         |    |          |                         |    |          |                         |    |          |                         |    |          |                         |    |          |                         |    |          |                         |    |          |                         |    |          |                         |    |          |                         |    |          |                         |    |          |                         |    |          |                         |    |          |                         |    |          |                         |    |          |                         |    |          |                         |    |          |                         |    |          |                         |    |          |                         |    |          |                         |    |          |                         |    |          |                         |    |          |                         |    |          |                         |    |          |                         |    |          |                         |    |          |                         |    |          |                         |    |          |                         |    |          |                         |    |          |                         |    |          |                         |    |          |                         |    |          |                         |    |          |                         |    |          |                         |    |          |                         |    |          |                         |    |          |                         |    |          |                         |    |          |                         |    |          |                         |    |          |                         |    |          |                         |    |          |                         |    |          |                         |    |          |                         |    |          |                         |    |          |                         |    |          |                         |    |          |                         |    |          |                         |    |          |                         |    |          |                         |    |          |                         |    |          |                         |    |          |                         |    |          |                         |    |          |                         |    |          |                         |    |          |                         |    |          |                         |    |          |                         |    |          |                         |    |          |                         |    |          |                         |    |          |                         |     |          |                         |  |  |   |
| 88  | 02/12/21   | REVISED AS PER COMMENTS  |  |   |          |                         |   |          |                         |   |          |                         |   |          |                         |   |          |                         |   |          |                         |   |          |                         |   |          |                         |   |          |                         |    |          |                         |    |          |                         |    |          |                         |    |          |                         |    |          |                         |    |          |                         |    |          |                         |    |          |                         |    |          |                         |    |          |                         |    |          |                         |    |          |                         |    |          |                         |    |          |                         |    |          |                         |    |          |                         |    |          |                         |    |          |                         |    |          |                         |    |          |                         |    |          |                         |    |          |                         |    |          |                         |    |          |                         |    |          |                         |    |          |                         |    |          |                         |    |          |                         |    |          |                         |    |          |                         |    |          |                         |    |          |                         |    |          |                         |    |          |                         |    |          |                         |    |          |                         |    |          |                         |    |          |                         |    |          |                         |    |          |                         |    |          |                         |    |          |                         |    |          |                         |    |          |                         |    |          |                         |    |          |                         |    |          |                         |    |          |                         |    |          |                         |    |          |                         |    |          |                         |    |          |                         |    |          |                         |    |          |                         |    |          |                         |    |          |                         |    |          |                         |    |          |                         |    |          |                         |    |          |                         |    |          |                         |    |          |                         |    |          |                         |    |          |                         |    |          |                         |    |          |                         |    |          |                         |    |          |                         |    |          |                         |    |          |                         |    |          |                         |    |          |                         |    |          |                         |    |          |                         |    |          |                         |    |          |                         |    |          |                         |    |          |                         |    |          |                         |    |          |                         |    |          |                         |    |          |                         |    |          |                         |    |          |                         |    |          |                         |    |          |                         |    |          |                         |    |          |                         |    |          |                         |    |          |                         |     |          |                         |  |  |   |
| 89  | 02/12/21   | REVISED AS PER COMMENTS  |  |   |          |                         |   |          |                         |   |          |                         |   |          |                         |   |          |                         |   |          |                         |   |          |                         |   |          |                         |   |          |                         |    |          |                         |    |          |                         |    |          |                         |    |          |                         |    |          |                         |    |          |                         |    |          |                         |    |          |                         |    |          |                         |    |          |                         |    |          |                         |    |          |                         |    |          |                         |    |          |                         |    |          |                         |    |          |                         |    |          |                         |    |          |                         |    |          |                         |    |          |                         |    |          |                         |    |          |                         |    |          |                         |    |          |                         |    |          |                         |    |          |                         |    |          |                         |    |          |                         |    |          |                         |    |          |                         |    |          |                         |    |          |                         |    |          |                         |    |          |                         |    |          |                         |    |          |                         |    |          |                         |    |          |                         |    |          |                         |    |          |                         |    |          |                         |    |          |                         |    |          |                         |    |          |                         |    |          |                         |    |          |                         |    |          |                         |    |          |                         |    |          |                         |    |          |                         |    |          |                         |    |          |                         |    |          |                         |    |          |                         |    |          |                         |    |          |                         |    |          |                         |    |          |                         |    |          |                         |    |          |                         |    |          |                         |    |          |                         |    |          |                         |    |          |                         |    |          |                         |    |          |                         |    |          |                         |    |          |                         |    |          |                         |    |          |                         |    |          |                         |    |          |                         |    |          |                         |    |          |                         |    |          |                         |    |          |                         |    |          |                         |    |          |                         |    |          |                         |    |          |                         |    |          |                         |    |          |                         |    |          |                         |    |          |                         |    |          |                         |    |          |                         |    |          |                         |    |          |                         |    |          |                         |    |          |                         |     |          |                         |  |  |   |
| 90  | 02/12/21   | REVISED AS PER COMMENTS  |  |   |          |                         |   |          |                         |   |          |                         |   |          |                         |   |          |                         |   |          |                         |   |          |                         |   |          |                         |   |          |                         |    |          |                         |    |          |                         |    |          |                         |    |          |                         |    |          |                         |    |          |                         |    |          |                         |    |          |                         |    |          |                         |    |          |                         |    |          |                         |    |          |                         |    |          |                         |    |          |                         |    |          |                         |    |          |                         |    |          |                         |    |          |                         |    |          |                         |    |          |                         |    |          |                         |    |          |                         |    |          |                         |    |          |                         |    |          |                         |    |          |                         |    |          |                         |    |          |                         |    |          |                         |    |          |                         |    |          |                         |    |          |                         |    |          |                         |    |          |                         |    |          |                         |    |          |                         |    |          |                         |    |          |                         |    |          |                         |    |          |                         |    |          |                         |    |          |                         |    |          |                         |    |          |                         |    |          |                         |    |          |                         |    |          |                         |    |          |                         |    |          |                         |    |          |                         |    |          |                         |    |          |                         |    |          |                         |    |          |                         |    |          |                         |    |          |                         |    |          |                         |    |          |                         |    |          |                         |    |          |                         |    |          |                         |    |          |                         |    |          |                         |    |          |                         |    |          |                         |    |          |                         |    |          |                         |    |          |                         |    |          |                         |    |          |                         |    |          |                         |    |          |                         |    |          |                         |    |          |                         |    |          |                         |    |          |                         |    |          |                         |    |          |                         |    |          |                         |    |          |                         |    |          |                         |    |          |                         |    |          |                         |    |          |                         |    |          |                         |    |          |                         |    |          |                         |    |          |                         |    |          |                         |    |          |                         |     |          |                         |  |  |   |
| 91  | 02/12/21   | REVISED AS PER COMMENTS  |  |   |          |                         |   |          |                         |   |          |                         |   |          |                         |   |          |                         |   |          |                         |   |          |                         |   |          |                         |   |          |                         |    |          |                         |    |          |                         |    |          |                         |    |          |                         |    |          |                         |    |          |                         |    |          |                         |    |          |                         |    |          |                         |    |          |                         |    |          |                         |    |          |                         |    |          |                         |    |          |                         |    |          |                         |    |          |                         |    |          |                         |    |          |                         |    |          |                         |    |          |                         |    |          |                         |    |          |                         |    |          |                         |    |          |                         |    |          |                         |    |          |                         |    |          |                         |    |          |                         |    |          |                         |    |          |                         |    |          |                         |    |          |                         |    |          |                         |    |          |                         |    |          |                         |    |          |                         |    |          |                         |    |          |                         |    |          |                         |    |          |                         |    |          |                         |    |          |                         |    |          |                         |    |          |                         |    |          |                         |    |          |                         |    |          |                         |    |          |                         |    |          |                         |    |          |                         |    |          |                         |    |          |                         |    |          |                         |    |          |                         |    |          |                         |    |          |                         |    |          |                         |    |          |                         |    |          |                         |    |          |                         |    |          |                         |    |          |                         |    |          |                         |    |          |                         |    |          |                         |    |          |                         |    |          |                         |    |          |                         |    |          |                         |    |          |                         |    |          |                         |    |          |                         |    |          |                         |    |          |                         |    |          |                         |    |          |                         |    |          |                         |    |          |                         |    |          |                         |    |          |                         |    |          |                         |    |          |                         |    |          |                         |    |          |                         |    |          |                         |    |          |                         |    |          |                         |    |          |                         |    |          |                         |    |          |                         |     |          |                         |  |  |   |
| 92  | 02/12/21   | REVISED AS PER COMMENTS  |  |   |          |                         |   |          |                         |   |          |                         |   |          |                         |   |          |                         |   |          |                         |   |          |                         |   |          |                         |   |          |                         |    |          |                         |    |          |                         |    |          |                         |    |          |                         |    |          |                         |    |          |                         |    |          |                         |    |          |                         |    |          |                         |    |          |                         |    |          |                         |    |          |                         |    |          |                         |    |          |                         |    |          |                         |    |          |                         |    |          |                         |    |          |                         |    |          |                         |    |          |                         |    |          |                         |    |          |                         |    |          |                         |    |          |                         |    |          |                         |    |          |                         |    |          |                         |    |          |                         |    |          |                         |    |          |                         |    |          |                         |    |          |                         |    |          |                         |    |          |                         |    |          |                         |    |          |                         |    |          |                         |    |          |                         |    |          |                         |    |          |                         |    |          |                         |    |          |                         |    |          |                         |    |          |                         |    |          |                         |    |          |                         |    |          |                         |    |          |                         |    |          |                         |    |          |                         |    |          |                         |    |          |                         |    |          |                         |    |          |                         |    |          |                         |    |          |                         |    |          |                         |    |          |                         |    |          |                         |    |          |                         |    |          |                         |    |          |                         |    |          |                         |    |          |                         |    |          |                         |    |          |                         |    |          |                         |    |          |                         |    |          |                         |    |          |                         |    |          |                         |    |          |                         |    |          |                         |    |          |                         |    |          |                         |    |          |                         |    |          |                         |    |          |                         |    |          |                         |    |          |                         |    |          |                         |    |          |                         |    |          |                         |    |          |                         |    |          |                         |    |          |                         |    |          |                         |    |          |                         |    |          |                         |    |          |                         |     |          |                         |  |  |   |
| 93  | 02/12/21   | REVISED AS PER COMMENTS  |  |   |          |                         |   |          |                         |   |          |                         |   |          |                         |   |          |                         |   |          |                         |   |          |                         |   |          |                         |   |          |                         |    |          |                         |    |          |                         |    |          |                         |    |          |                         |    |          |                         |    |          |                         |    |          |                         |    |          |                         |    |          |                         |    |          |                         |    |          |                         |    |          |                         |    |          |                         |    |          |                         |    |          |                         |    |          |                         |    |          |                         |    |          |                         |    |          |                         |    |          |                         |    |          |                         |    |          |                         |    |          |                         |    |          |                         |    |          |                         |    |          |                         |    |          |                         |    |          |                         |    |          |                         |    |          |                         |    |          |                         |    |          |                         |    |          |                         |    |          |                         |    |          |                         |    |          |                         |    |          |                         |    |          |                         |    |          |                         |    |          |                         |    |          |                         |    |          |                         |    |          |                         |    |          |                         |    |          |                         |    |          |                         |    |          |                         |    |          |                         |    |          |                         |    |          |                         |    |          |                         |    |          |                         |    |          |                         |    |          |                         |    |          |                         |    |          |                         |    |          |                         |    |          |                         |    |          |                         |    |          |                         |    |          |                         |    |          |                         |    |          |                         |    |          |                         |    |          |                         |    |          |                         |    |          |                         |    |          |                         |    |          |                         |    |          |                         |    |          |                         |    |          |                         |    |          |                         |    |          |                         |    |          |                         |    |          |                         |    |          |                         |    |          |                         |    |          |                         |    |          |                         |    |          |                         |    |          |                         |    |          |                         |    |          |                         |    |          |                         |    |          |                         |    |          |                         |    |          |                         |    |          |                         |    |          |                         |     |          |                         |  |  |   |
| 94  | 02/12/21   | REVISED AS PER COMMENTS  |  |   |          |                         |   |          |                         |   |          |                         |   |          |                         |   |          |                         |   |          |                         |   |          |                         |   |          |                         |   |          |                         |    |          |                         |    |          |                         |    |          |                         |    |          |                         |    |          |                         |    |          |                         |    |          |                         |    |          |                         |    |          |                         |    |          |                         |    |          |                         |    |          |                         |    |          |                         |    |          |                         |    |          |                         |    |          |                         |    |          |                         |    |          |                         |    |          |                         |    |          |                         |    |          |                         |    |          |                         |    |          |                         |    |          |                         |    |          |                         |    |          |                         |    |          |                         |    |          |                         |    |          |                         |    |          |                         |    |          |                         |    |          |                         |    |          |                         |    |          |                         |    |          |                         |    |          |                         |    |          |                         |    |          |                         |    |          |                         |    |          |                         |    |          |                         |    |          |                         |    |          |                         |    |          |                         |    |          |                         |    |          |                         |    |          |                         |    |          |                         |    |          |                         |    |          |                         |    |          |                         |    |          |                         |    |          |                         |    |          |                         |    |          |                         |    |          |                         |    |          |                         |    |          |                         |    |          |                         |    |          |                         |    |          |                         |    |          |                         |    |          |                         |    |          |                         |    |          |                         |    |          |                         |    |          |                         |    |          |                         |    |          |                         |    |          |                         |    |          |                         |    |          |                         |    |          |                         |    |          |                         |    |          |                         |    |          |                         |    |          |                         |    |          |                         |    |          |                         |    |          |                         |    |          |                         |    |          |                         |    |          |                         |    |          |                         |    |          |                         |    |          |                         |    |          |                         |    |          |                         |    |          |                         |    |          |                         |     |          |                         |  |  |   |
| 95  | 02/12/21   | REVISED AS PER COMMENTS  |  |   |          |                         |   |          |                         |   |          |                         |   |          |                         |   |          |                         |   |          |                         |   |          |                         |   |          |                         |   |          |                         |    |          |                         |    |          |                         |    |          |                         |    |          |                         |    |          |                         |    |          |                         |    |          |                         |    |          |                         |    |          |                         |    |          |                         |    |          |                         |    |          |                         |    |          |                         |    |          |                         |    |          |                         |    |          |                         |    |          |                         |    |          |                         |    |          |                         |    |          |                         |    |          |                         |    |          |                         |    |          |                         |    |          |                         |    |          |                         |    |          |                         |    |          |                         |    |          |                         |    |          |                         |    |          |                         |    |          |                         |    |          |                         |    |          |                         |    |          |                         |    |          |                         |    |          |                         |    |          |                         |    |          |                         |    |          |                         |    |          |                         |    |          |                         |    |          |                         |    |          |                         |    |          |                         |    |          |                         |    |          |                         |    |          |                         |    |          |                         |    |          |                         |    |          |                         |    |          |                         |    |          |                         |    |          |                         |    |          |                         |    |          |                         |    |          |                         |    |          |                         |    |          |                         |    |          |                         |    |          |                         |    |          |                         |    |          |                         |    |          |                         |    |          |                         |    |          |                         |    |          |                         |    |          |                         |    |          |                         |    |          |                         |    |          |                         |    |          |                         |    |          |                         |    |          |                         |    |          |                         |    |          |                         |    |          |                         |    |          |                         |    |          |                         |    |          |                         |    |          |                         |    |          |                         |    |          |                         |    |          |                         |    |          |                         |    |          |                         |    |          |                         |    |          |                         |    |          |                         |    |          |                         |    |          |                         |     |          |                         |  |  |   |
| 96  | 02/12/21   | REVISED AS PER COMMENTS  |  |   |          |                         |   |          |                         |   |          |                         |   |          |                         |   |          |                         |   |          |                         |   |          |                         |   |          |                         |   |          |                         |    |          |                         |    |          |                         |    |          |                         |    |          |                         |    |          |                         |    |          |                         |    |          |                         |    |          |                         |    |          |                         |    |          |                         |    |          |                         |    |          |                         |    |          |                         |    |          |                         |    |          |                         |    |          |                         |    |          |                         |    |          |                         |    |          |                         |    |          |                         |    |          |                         |    |          |                         |    |          |                         |    |          |                         |    |          |                         |    |          |                         |    |          |                         |    |          |                         |    |          |                         |    |          |                         |    |          |                         |    |          |                         |    |          |                         |    |          |                         |    |          |                         |    |          |                         |    |          |                         |    |          |                         |    |          |                         |    |          |                         |    |          |                         |    |          |                         |    |          |                         |    |          |                         |    |          |                         |    |          |                         |    |          |                         |    |          |                         |    |          |                         |    |          |                         |    |          |                         |    |          |                         |    |          |                         |    |          |                         |    |          |                         |    |          |                         |    |          |                         |    |          |                         |    |          |                         |    |          |                         |    |          |                         |    |          |                         |    |          |                         |    |          |                         |    |          |                         |    |          |                         |    |          |                         |    |          |                         |    |          |                         |    |          |                         |    |          |                         |    |          |                         |    |          |                         |    |          |                         |    |          |                         |    |          |                         |    |          |                         |    |          |                         |    |          |                         |    |          |                         |    |          |                         |    |          |                         |    |          |                         |    |          |                         |    |          |                         |    |          |                         |    |          |                         |    |          |                         |    |          |                         |    |          |                         |     |          |                         |  |  |   |
| 97  | 02/12/21   | REVISED AS PER COMMENTS  |  |   |          |                         |   |          |                         |   |          |                         |   |          |                         |   |          |                         |   |          |                         |   |          |                         |   |          |                         |   |          |                         |    |          |                         |    |          |                         |    |          |                         |    |          |                         |    |          |                         |    |          |                         |    |          |                         |    |          |                         |    |          |                         |    |          |                         |    |          |                         |    |          |                         |    |          |                         |    |          |                         |    |          |                         |    |          |                         |    |          |                         |    |          |                         |    |          |                         |    |          |                         |    |          |                         |    |          |                         |    |          |                         |    |          |                         |    |          |                         |    |          |                         |    |          |                         |    |          |                         |    |          |                         |    |          |                         |    |          |                         |    |          |                         |    |          |                         |    |          |                         |    |          |                         |    |          |                         |    |          |                         |    |          |                         |    |          |                         |    |          |                         |    |          |                         |    |          |                         |    |          |                         |    |          |                         |    |          |                         |    |          |                         |    |          |                         |    |          |                         |    |          |                         |    |          |                         |    |          |                         |    |          |                         |    |          |                         |    |          |                         |    |          |                         |    |          |                         |    |          |                         |    |          |                         |    |          |                         |    |          |                         |    |          |                         |    |          |                         |    |          |                         |    |          |                         |    |          |                         |    |          |                         |    |          |                         |    |          |                         |    |          |                         |    |          |                         |    |          |                         |    |          |                         |    |          |                         |    |          |                         |    |          |                         |    |          |                         |    |          |                         |    |          |                         |    |          |                         |    |          |                         |    |          |                         |    |          |                         |    |          |                         |    |          |                         |    |          |                         |    |          |                         |    |          |                         |    |          |                         |    |          |                         |    |          |                         |     |          |                         |  |  |   |
| 98  | 02/12/21   | REVISED AS PER COMMENTS  |  |   |          |                         |   |          |                         |   |          |                         |   |          |                         |   |          |                         |   |          |                         |   |          |                         |   |          |                         |   |          |                         |    |          |                         |    |          |                         |    |          |                         |    |          |                         |    |          |                         |    |          |                         |    |          |                         |    |          |                         |    |          |                         |    |          |                         |    |          |                         |    |          |                         |    |          |                         |    |          |                         |    |          |                         |    |          |                         |    |          |                         |    |          |                         |    |          |                         |    |          |                         |    |          |                         |    |          |                         |    |          |                         |    |          |                         |    |          |                         |    |          |                         |    |          |                         |    |          |                         |    |          |                         |    |          |                         |    |          |                         |    |          |                         |    |          |                         |    |          |                         |    |          |                         |    |          |                         |    |          |                         |    |          |                         |    |          |                         |    |          |                         |    |          |                         |    |          |                         |    |          |                         |    |          |                         |    |          |                         |    |          |                         |    |          |                         |    |          |                         |    |          |                         |    |          |                         |    |          |                         |    |          |                         |    |          |                         |    |          |                         |    |          |                         |    |          |                         |    |          |                         |    |          |                         |    |          |                         |    |          |                         |    |          |                         |    |          |                         |    |          |                         |    |          |                         |    |          |                         |    |          |                         |    |          |                         |    |          |                         |    |          |                         |    |          |                         |    |          |                         |    |          |                         |    |          |                         |    |          |                         |    |          |                         |    |          |                         |    |          |                         |    |          |                         |    |          |                         |    |          |                         |    |          |                         |    |          |                         |    |          |                         |    |          |                         |    |          |                         |    |          |                         |    |          |                         |    |          |                         |    |          |                         |    |          |                         |     |          |                         |  |  |   |
| 99  | 02/12/21   | REVISED AS PER COMMENTS  |  |   |          |                         |   |          |                         |   |          |                         |   |          |                         |   |          |                         |   |          |                         |   |          |                         |   |          |                         |   |          |                         |    |          |                         |    |          |                         |    |          |                         |    |          |                         |    |          |                         |    |          |                         |    |          |                         |    |          |                         |    |          |                         |    |          |                         |    |          |                         |    |          |                         |    |          |                         |    |          |                         |    |          |                         |    |          |                         |    |          |                         |    |          |                         |    |          |                         |    |          |                         |    |          |                         |    |          |                         |    |          |                         |    |          |                         |    |          |                         |    |          |                         |    |          |                         |    |          |                         |    |          |                         |    |          |                         |    |          |                         |    |          |                         |    |          |                         |    |          |                         |    |          |                         |    |          |                         |    |          |                         |    |          |                         |    |          |                         |    |          |                         |    |          |                         |    |          |                         |    |          |                         |    |          |                         |    |          |                         |    |          |                         |    |          |                         |    |          |                         |    |          |                         |    |          |                         |    |          |                         |    |          |                         |    |          |                         |    |          |                         |    |          |                         |    |          |                         |    |          |                         |    |          |                         |    |          |                         |    |          |                         |    |          |                         |    |          |                         |    |          |                         |    |          |                         |    |          |                         |    |          |                         |    |          |                         |    |          |                         |    |          |                         |    |          |                         |    |          |                         |    |          |                         |    |          |                         |    |          |                         |    |          |                         |    |          |                         |    |          |                         |    |          |                         |    |          |                         |    |          |                         |    |          |                         |    |          |                         |    |          |                         |    |          |                         |    |          |                         |    |          |                         |    |          |                         |    |          |                         |    |          |                         |    |          |                         |     |          |                         |  |  |   |
| 100   | 02/12/21   | REVISED AS PER COMMENTS  |  |   |          |                         |   |          |                         |   |          |                         |   |          |                         |   |          |                         |   |          |                         |   |          |                         |   |          |                         |   |          |                         |    |          |                         |    |          |                         |    |          |                         |    |          |                         |    |          |                         |    |          |                         |    |          |                         |    |          |                         |    |          |                         |    |          |                         |    |          |                         |    |          |                         |    |          |                         |    |          |                         |    |          |                         |    |          |                         |    |          |                         |    |          |                         |    |          |                         |    |          |                         |    |          |                         |    |          |                         |    |          |                         |    |          |                         |    |          |                         |    |          |                         |    |          |                         |    |          |                         |    |          |                         |    |          |                         |    |          |                         |    |          |                         |    |          |                         |    |          |                         |    |          |                         |    |          |                         |    |          |                         |    |          |                         |    |          |                         |    |          |                         |    |          |                         |    |          |                         |    |          |                         |    |          |                         |    |          |                         |    |          |                         |    |          |                         |    |          |                         |    |          |                         |    |          |                         |    |          |                         |    |          |                         |    |          |                         |    |          |                         |    |          |                         |    |          |                         |    |          |                         |    |          |                         |    |          |                         |    |          |                         |    |          |                         |    |          |                         |    |          |                         |    |          |                         |    |          |                         |    |          |                         |    |          |                         |    |          |                         |    |          |                         |    |          |                         |    |          |                         |    |          |                         |    |          |                         |    |          |                         |    |          |                         |    |          |                         |    |          |                         |    |          |                         |    |          |                         |    |          |                         |    |          |                         |    |          |                         |    |          |                         |    |          |                         |    |          |                         |    |          |                         |    |          |                         |    |          |                         |    |          |                         |    |          |                         |     |          |                         |  |  |   |

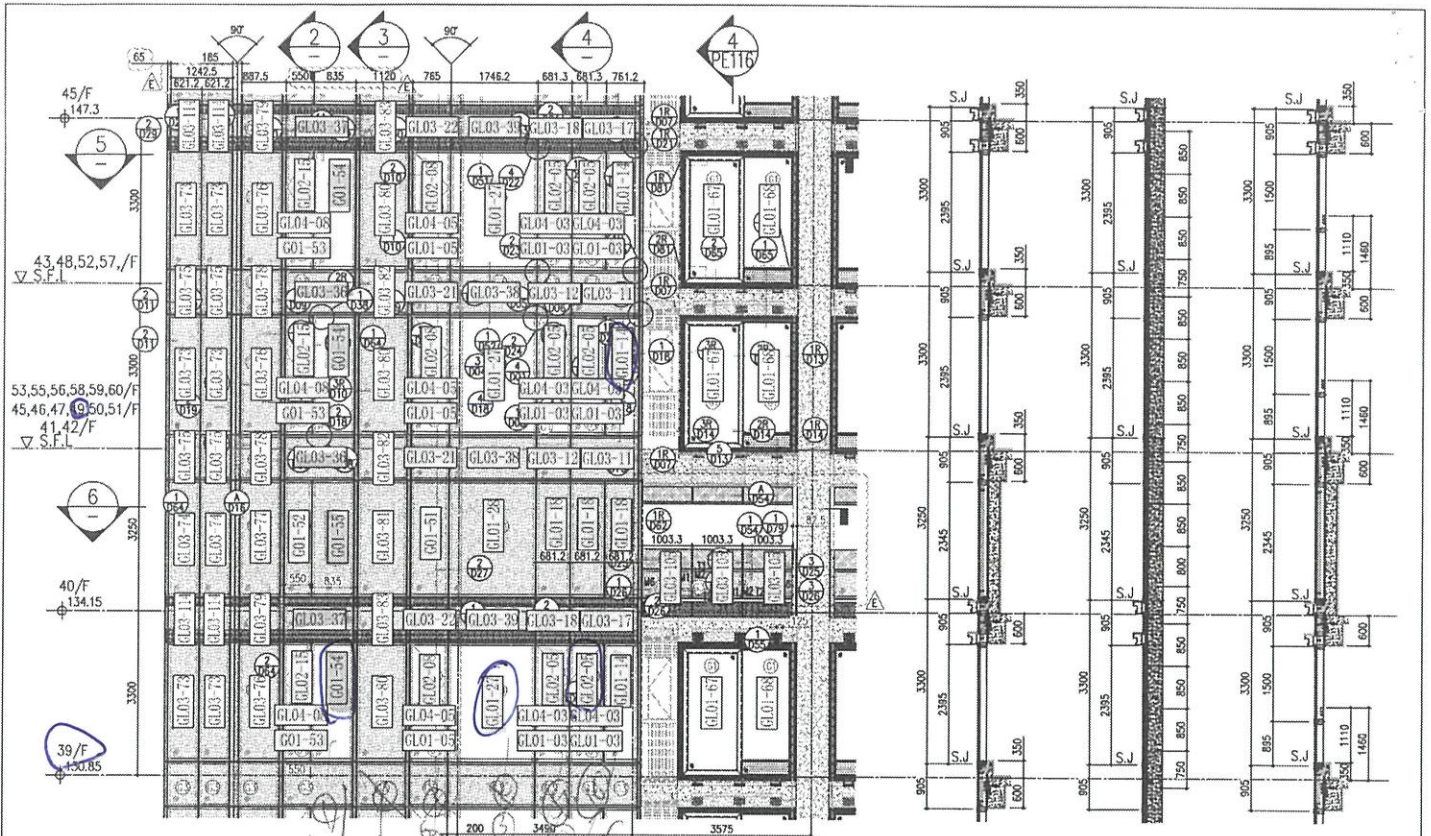

SECTION 2 SECTION 3 SECTION 4

GL01-27 39AE  
GL01-54 39AE

GL01-14 49AE

GL02-05 39AE

ARCH. FEATURE AT 39/F,  
43/F, 48/F, 52/F, 57/F

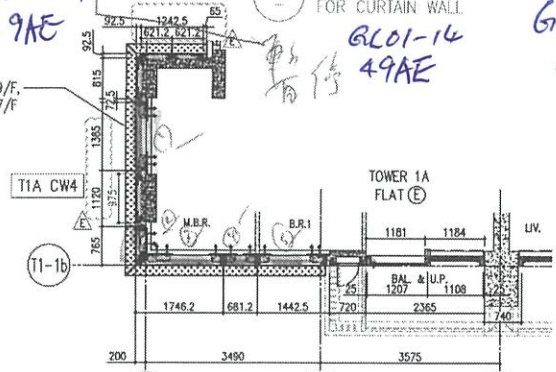

5 PART PLAN FOR CURTAIN WALL

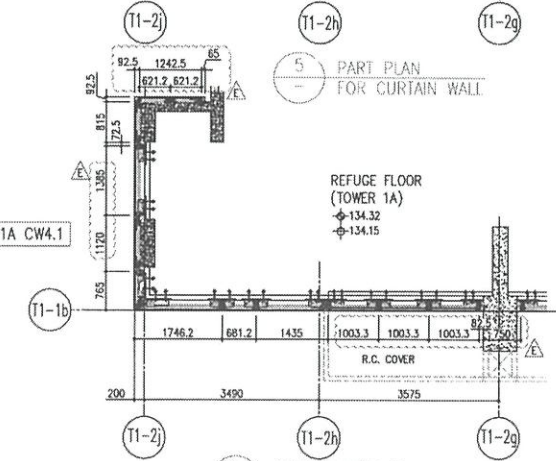

6 PART PLAN (40/F) FOR CURTAIN WALL

|      |        |      |         |      |         |      |         |
|------|--------|------|---------|------|---------|------|---------|
| 26/F | +91.25 | 39/F | +130.85 | 52/F | +170.40 |      |         |
| 25/F | +87.95 | 38/F | +127.55 | 51/F | +167.10 | R/F  | +203.80 |
| 23/F | +84.65 | 37/F | +124.25 | 50/F | +163.80 | 62/F | +200.30 |
| 22/F | +81.35 | 36/F | +120.95 | 49/F | +160.50 | 61/F | +196.80 |
| 21/F | +78.05 | 35/F | +117.65 | 48/F | +157.20 | 60/F | +193.50 |
| 20/F | +74.75 | 33/F | +114.35 | 47/F | +153.90 | 59/F | +190.20 |
| 19/F | +71.45 | 32/F | +111.05 | 46/F | +150.60 | 58/F | +186.90 |
| 18/F | +68.15 | 31/F | +107.75 | 45/F | +147.30 | 57/F | +183.60 |
| 17/F | +64.85 | 30/F | +104.45 | 43/F | +144.00 | 56/F | +180.30 |
| 16/F | +61.55 | 29/F | +101.15 | 42/F | +140.70 | 55/F | +177.00 |
| 15/F | +58.25 | 28/F | +97.85  | 41/F | +137.40 | 53/F | +173.70 |
| 12/F | +54.95 | 27/F | +94.55  | 40/F | +134.15 |      |         |

- LEGEND:**
- 10mm THK. HEAT STRENGTHENED GLASS (OUTSIDE) + 12mm AIR SPACE + 12mm THK. TEMPERED GLASS
  - 10mm THK. HEAT STRENGTHENED GLASS (OUTSIDE) + 12mm AIR SPACE + 10mm THK. TEMPERED GLASS
  - 12mm THK. HEAT STRENGTHENED GLASS
  - 12mm THK. CLEAR TEMPERED GLASS (INTERNAL PROTECTIVE BARRIER)
  - 10mm BLUE TINTED HEAT STRENGTHENED GLASS
  - 10mm THK. CLEAR TEMPERED GLASS
  - 8mm THK. CLEAR HEAT-STRENGTHENED GLASS + 15mm PVB + 8mm THK. CLEAR HEAT-STRENGTHENED GLASS
  - 3 mm THK. ALUM. CLADDING
  - 3 mm THK. ALUM. BACKPAN
  - S.J. - STACK JOINT

| <p><b>CLIENT:</b><br/>信和置業有限公司<br/>Sino Land Company Limited</p> <p><b>ARCHITECT:</b><br/>ronald lu &amp; partners<br/>Ronald Lu &amp; Partners (HK) Ltd.<br/>吳冠廷建築師事務所(信和)有限公司</p> <p><b>MAIN CONTRACTOR:</b><br/>M&amp;P</p> <p><b>STRUCTURAL ENGINEER:</b><br/>Gammom</p> <p><b>MECHANICAL ENGINEER:</b><br/>AECOM</p> <p><b>FAÇADE CONSULTANT:</b><br/>AECOM</p>  | <p><b>DATE:</b> 22-OCT-21</p> <p><b>SCALE:</b> 1:50(A1)</p> <p><b>DRAWN BY:</b></p> <p><b>CHECKED BY:</b></p> | <p><b>TITLE:</b><br/>TYPICAL FLOOR PARTIAL ELEVATION &amp; SECTION, PLAN FOR CURTAIN WALL (TOWER 1)</p> | <p><b>PROJECT:</b><br/>POSED RESIDENTIAL DEVELOPMENT AT TOWER 209P PHASE 11, LOHAS PARK, TSEUNG KWAN O, N.T.</p> | <p><b>JOB NO.:</b> J-558</p> | <p><b>REVISIONS:</b></p> <table border="1"> <tr> <th>NO.</th> <th>DATE</th> <th>REVISIONS</th> </tr> <tr> <td>1</td> <td>13/06/21</td> <td>REVISED AS PER COMMENTS</td> </tr> <tr> <td>2</td> <td>06/06/21</td> <td>REVISED AS PER COMMENTS</td> </tr> <tr> <td>3</td> <td>17/02/21</td> <td>REVISED AS PER COMMENTS</td> </tr> <tr> <td>4</td> <td>20/12/21</td> <td>REVISED AS PER COMMENTS</td> </tr> <tr> <td>5</td> <td>09/12/21</td> <td>REVISED AS PER COMMENTS</td> </tr> <tr> <td>6</td> <td></td> <td>REVISED</td> </tr> </table> | NO.                     | DATE      | REVISIONS | 1                       | 13/06/21 | REVISED AS PER COMMENTS | 2                       | 06/06/21 | REVISED AS PER COMMENTS | 3                       | 17/02/21 | REVISED AS PER COMMENTS | 4                       | 20/12/21 | REVISED AS PER COMMENTS | 5       | 09/12/21  | REVISED AS PER COMMENTS | 6    |           | REVISED | <p><b>NOTES:</b></p> <ol style="list-style-type: none"> <li>ALL DIMENSIONS ARE IN mm.</li> <li>ALL ELEVATIONS ARE VIEWED FROM OUTSIDE UNLESS SPECIFIED OTHERWISE.</li> <li>ALL DIMENSIONS TO BE CHECKED ON SITE.</li> </ol> <p><b>LEGEND:</b></p> <ul style="list-style-type: none"> <li> DETAIL MARK NO.</li> <li> REVISED SHEET NO.</li> <li> REVISION FLOOR LEVEL.</li> <li> S.F.L. - STRUCTURAL FLOOR LEVEL.</li> <li> -- REVERSED DETAIL.</li> </ul> | <p><b>DATE:</b> 22-OCT-21</p> <p><b>SCALE:</b> 1:50(A1)</p> <p><b>DRAWN BY:</b></p> <p><b>CHECKED BY:</b></p> | <p><b>TITLE:</b><br/>TYPICAL FLOOR PARTIAL ELEVATION &amp; SECTION, PLAN FOR CURTAIN WALL (TOWER 1)</p> | <p><b>PROJECT:</b><br/>POSED RESIDENTIAL DEVELOPMENT AT TOWER 209P PHASE 11, LOHAS PARK, TSEUNG KWAN O, N.T.</p> | <p><b>JOB NO.:</b> J-558</p> | <p><b>REVISIONS:</b></p> <table border="1"> <tr> <th>NO.</th> <th>DATE</th> <th>REVISIONS</th> </tr> <tr> <td>1</td> <td>13/06/21</td> <td>REVISED AS PER COMMENTS</td> </tr> <tr> <td>2</td> <td>06/06/21</td> <td>REVISED AS PER COMMENTS</td> </tr> <tr> <td>3</td> <td>17/02/21</td> <td>REVISED AS PER COMMENTS</td> </tr> <tr> <td>4</td> <td>20/12/21</td> <td>REVISED AS PER COMMENTS</td> </tr> <tr> <td>5</td> <td>09/12/21</td> <td>REVISED AS PER COMMENTS</td> </tr> <tr> <td>6</td> <td></td> <td>REVISED</td> </tr> </table> | NO.      | DATE                    | REVISIONS | 1        | 13/06/21                | REVISED AS PER COMMENTS | 2        | 06/06/21                | REVISED AS PER COMMENTS | 3 | 17/02/21 | REVISED AS PER COMMENTS | 4 | 20/12/21 | REVISED AS PER COMMENTS | 5 | 09/12/21 | REVISED AS PER COMMENTS | 6 |  | REVISED |
|---|---|---|--|------------------------------|---|-------------------------|-----------|-----------|-------------------------|----------|-------------------------|-------------------------|----------|-------------------------|-------------------------|----------|-------------------------|-------------------------|----------|-------------------------|---------|---|-------------------------|------|-----------|---------|---|---|---|--|------------------------------|---|----------|-------------------------|-----------|----------|-------------------------|-------------------------|----------|-------------------------|-------------------------|---|----------|-------------------------|---|----------|-------------------------|---|----------|-------------------------|---|--|---------|
|   |   |   |  |                              | NO.   | DATE                    | REVISIONS |           |                         |          |                         |                         |          |                         |                         |          |                         |                         |          |                         |         |   |                         |      |           |         |   |   |   |  |                              |   |          |                         |           |          |                         |                         |          |                         |                         |   |          |                         |   |          |                         |   |          |                         |   |  |         |
| 1   | 13/06/21  | REVISED AS PER COMMENTS   |  |                              |   |                         |           |           |                         |          |                         |                         |          |                         |                         |          |                         |                         |          |                         |         |   |                         |      |           |         |   |   |   |  |                              |   |          |                         |           |          |                         |                         |          |                         |                         |   |          |                         |   |          |                         |   |          |                         |   |  |         |
| 2   | 06/06/21  | REVISED AS PER COMMENTS   |  |                              |   |                         |           |           |                         |          |                         |                         |          |                         |                         |          |                         |                         |          |                         |         |   |                         |      |           |         |   |   |   |  |                              |   |          |                         |           |          |                         |                         |          |                         |                         |   |          |                         |   |          |                         |   |          |                         |   |  |         |
| 3   | 17/02/21  | REVISED AS PER COMMENTS   |  |                              |   |                         |           |           |                         |          |                         |                         |          |                         |                         |          |                         |                         |          |                         |         |   |                         |      |           |         |   |   |   |  |                              |   |          |                         |           |          |                         |                         |          |                         |                         |   |          |                         |   |          |                         |   |          |                         |   |  |         |
| 4   | 20/12/21  | REVISED AS PER COMMENTS   |  |                              |   |                         |           |           |                         |          |                         |                         |          |                         |                         |          |                         |                         |          |                         |         |   |                         |      |           |         |   |   |   |  |                              |   |          |                         |           |          |                         |                         |          |                         |                         |   |          |                         |   |          |                         |   |          |                         |   |  |         |
| 5   | 09/12/21  | REVISED AS PER COMMENTS   |  |                              |   |                         |           |           |                         |          |                         |                         |          |                         |                         |          |                         |                         |          |                         |         |   |                         |      |           |         |   |   |   |  |                              |   |          |                         |           |          |                         |                         |          |                         |                         |   |          |                         |   |          |                         |   |          |                         |   |  |         |
| 6   |   | REVISED   |  |                              |   |                         |           |           |                         |          |                         |                         |          |                         |                         |          |                         |                         |          |                         |         |   |                         |      |           |         |   |   |   |  |                              |   |          |                         |           |          |                         |                         |          |                         |                         |   |          |                         |   |          |                         |   |          |                         |   |  |         |
| NO.   | DATE  | REVISIONS   |  |                              |   |                         |           |           |                         |          |                         |                         |          |                         |                         |          |                         |                         |          |                         |         |   |                         |      |           |         |   |   |   |  |                              |   |          |                         |           |          |                         |                         |          |                         |                         |   |          |                         |   |          |                         |   |          |                         |   |  |         |
| 1   | 13/06/21  | REVISED AS PER COMMENTS   |  |                              |   |                         |           |           |                         |          |                         |                         |          |                         |                         |          |                         |                         |          |                         |         |   |                         |      |           |         |   |   |   |  |                              |   |          |                         |           |          |                         |                         |          |                         |                         |   |          |                         |   |          |                         |   |          |                         |   |  |         |
| 2   | 06/06/21  | REVISED AS PER COMMENTS   |  |                              |   |                         |           |           |                         |          |                         |                         |          |                         |                         |          |                         |                         |          |                         |         |   |                         |      |           |         |   |   |   |  |                              |   |          |                         |           |          |                         |                         |          |                         |                         |   |          |                         |   |          |                         |   |          |                         |   |  |         |
| 3   | 17/02/21  | REVISED AS PER COMMENTS   |  |                              |   |                         |           |           |                         |          |                         |                         |          |                         |                         |          |                         |                         |          |                         |         |   |                         |      |           |         |   |   |   |  |                              |   |          |                         |           |          |                         |                         |          |                         |                         |   |          |                         |   |          |                         |   |          |                         |   |  |         |
| 4   | 20/12/21  | REVISED AS PER COMMENTS   |  |                              |   |                         |           |           |                         |          |                         |                         |          |                         |                         |          |                         |                         |          |                         |         |   |                         |      |           |         |   |   |   |  |                              |   |          |                         |           |          |                         |                         |          |                         |                         |   |          |                         |   |          |                         |   |          |                         |   |  |         |
| 5   | 09/12/21  | REVISED AS PER COMMENTS   |  |                              |   |                         |           |           |                         |          |                         |                         |          |                         |                         |          |                         |                         |          |                         |         |   |                         |      |           |         |   |   |   |  |                              |   |          |                         |           |          |                         |                         |          |                         |                         |   |          |                         |   |          |                         |   |          |                         |   |  |         |
| 6   |   | REVISED   |  |                              |   |                         |           |           |                         |          |                         |                         |          |                         |                         |          |                         |                         |          |                         |         |   |                         |      |           |         |   |   |   |  |                              |   |          |                         |           |          |                         |                         |          |                         |                         |   |          |                         |   |          |                         |   |          |                         |   |  |         |
| <p><b>REVISIONS:</b></p> <table border="1"> <tr> <th>NO.</th> <th>DATE</th> <th>REVISIONS</th> </tr> <tr> <td>1</td> <td>13/06/21</td> <td>REVISED AS PER COMMENTS</td> </tr> <tr> <td>2</td> <td>06/06/21</td> <td>REVISED AS PER COMMENTS</td> </tr> <tr> <td>3</td> <td>17/02/21</td> <td>REVISED AS PER COMMENTS</td> </tr> <tr> <td>4</td> <td>20/12/21</td> <td>REVISED AS PER COMMENTS</td> </tr> <tr> <td>5</td> <td>09/12/21</td> <td>REVISED AS PER COMMENTS</td> </tr> <tr> <td>6</td> <td></td> <td>REVISED</td> </tr> </table> | NO.   | DATE  | REVISIONS  | 1                            | 13/06/21  | REVISED AS PER COMMENTS | 2         | 06/06/21  | REVISED AS PER COMMENTS | 3        | 17/02/21                | REVISED AS PER COMMENTS | 4        | 20/12/21                | REVISED AS PER COMMENTS | 5        | 09/12/21                | REVISED AS PER COMMENTS | 6        |                         | REVISED | <p><b>REVISIONS:</b></p> <table border="1"> <tr> <th>NO.</th> <th>DATE</th> <th>REVISIONS</th> </tr> <tr> <td>1</td> <td>13/06/21</td> <td>REVISED AS PER COMMENTS</td> </tr> <tr> <td>2</td> <td>06/06/21</td> <td>REVISED AS PER COMMENTS</td> </tr> <tr> <td>3</td> <td>17/02/21</td> <td>REVISED AS PER COMMENTS</td> </tr> <tr> <td>4</td> <td>20/12/21</td> <td>REVISED AS PER COMMENTS</td> </tr> <tr> <td>5</td> <td>09/12/21</td> <td>REVISED AS PER COMMENTS</td> </tr> <tr> <td>6</td> <td></td> <td>REVISED</td> </tr> </table> | NO.                     | DATE | REVISIONS | 1       | 13/06/21  | REVISED AS PER COMMENTS   | 2   | 06/06/21   | REVISED AS PER COMMENTS      | 3   | 17/02/21 | REVISED AS PER COMMENTS | 4         | 20/12/21 | REVISED AS PER COMMENTS | 5                       | 09/12/21 | REVISED AS PER COMMENTS | 6                       |   | REVISED  |                         |   |          |                         |   |          |                         |   |  |         |
| NO.   | DATE  | REVISIONS   |  |                              |   |                         |           |           |                         |          |                         |                         |          |                         |                         |          |                         |                         |          |                         |         |   |                         |      |           |         |   |   |   |  |                              |   |          |                         |           |          |                         |                         |          |                         |                         |   |          |                         |   |          |                         |   |          |                         |   |  |         |
| 1   | 13/06/21  | REVISED AS PER COMMENTS   |  |                              |   |                         |           |           |                         |          |                         |                         |          |                         |                         |          |                         |                         |          |                         |         |   |                         |      |           |         |   |   |   |  |                              |   |          |                         |           |          |                         |                         |          |                         |                         |   |          |                         |   |          |                         |   |          |                         |   |  |         |
| 2   | 06/06/21  | REVISED AS PER COMMENTS   |  |                              |   |                         |           |           |                         |          |                         |                         |          |                         |                         |          |                         |                         |          |                         |         |   |                         |      |           |         |   |   |   |  |                              |   |          |                         |           |          |                         |                         |          |                         |                         |   |          |                         |   |          |                         |   |          |                         |   |  |         |
| 3   | 17/02/21  | REVISED AS PER COMMENTS   |  |                              |   |                         |           |           |                         |          |                         |                         |          |                         |                         |          |                         |                         |          |                         |         |   |                         |      |           |         |   |   |   |  |                              |   |          |                         |           |          |                         |                         |          |                         |                         |   |          |                         |   |          |                         |   |          |                         |   |  |         |
| 4   | 20/12/21  | REVISED AS PER COMMENTS   |  |                              |   |                         |           |           |                         |          |                         |                         |          |                         |                         |          |                         |                         |          |                         |         |   |                         |      |           |         |   |   |   |  |                              |   |          |                         |           |          |                         |                         |          |                         |                         |   |          |                         |   |          |                         |   |          |                         |   |  |         |
| 5   | 09/12/21  | REVISED AS PER COMMENTS   |  |                              |   |                         |           |           |                         |          |                         |                         |          |                         |                         |          |                         |                         |          |                         |         |   |                         |      |           |         |   |   |   |  |                              |   |          |                         |           |          |                         |                         |          |                         |                         |   |          |                         |   |          |                         |   |          |                         |   |  |         |
| 6   |   | REVISED   |  |                              |   |                         |           |           |                         |          |                         |                         |          |                         |                         |          |                         |                         |          |                         |         |   |                         |      |           |         |   |   |   |  |                              |   |          |                         |           |          |                         |                         |          |                         |                         |   |          |                         |   |          |                         |   |          |                         |   |  |         |
| NO.   | DATE  | REVISIONS   |  |                              |   |                         |           |           |                         |          |                         |                         |          |                         |                         |          |                         |                         |          |                         |         |   |                         |      |           |         |   |   |   |  |                              |   |          |                         |           |          |                         |                         |          |                         |                         |   |          |                         |   |          |                         |   |          |                         |   |  |         |
| 1   | 13/06/21  | REVISED AS PER COMMENTS   |  |                              |   |                         |           |           |                         |          |                         |                         |          |                         |                         |          |                         |                         |          |                         |         |   |                         |      |           |         |   |   |   |  |                              |   |          |                         |           |          |                         |                         |          |                         |                         |   |          |                         |   |          |                         |   |          |                         |   |  |         |
| 2   | 06/06/21  | REVISED AS PER COMMENTS   |  |                              |   |                         |           |           |                         |          |                         |                         |          |                         |                         |          |                         |                         |          |                         |         |   |                         |      |           |         |   |   |   |  |                              |   |          |                         |           |          |                         |                         |          |                         |                         |   |          |                         |   |          |                         |   |          |                         |   |  |         |
| 3   | 17/02/21  | REVISED AS PER COMMENTS   |  |                              |   |                         |           |           |                         |          |                         |                         |          |                         |                         |          |                         |                         |          |                         |         |   |                         |      |           |         |   |   |   |  |                              |   |          |                         |           |          |                         |                         |          |                         |                         |   |          |                         |   |          |                         |   |          |                         |   |  |         |
| 4   | 20/12/21  | REVISED AS PER COMMENTS   |  |                              |   |                         |           |           |                         |          |                         |                         |          |                         |                         |          |                         |                         |          |                         |         |   |                         |      |           |         |   |   |   |  |                              |   |          |                         |           |          |                         |                         |          |                         |                         |   |          |                         |   |          |                         |   |          |                         |   |  |         |
| 5   | 09/12/21  | REVISED AS PER COMMENTS   |  |                              |   |                         |           |           |                         |          |                         |                         |          |                         |                         |          |                         |                         |          |                         |         |   |                         |      |           |         |   |   |   |  |                              |   |          |                         |           |          |                         |                         |          |                         |                         |   |          |                         |   |          |                         |   |          |                         |   |  |         |
| 6   |   | REVISED   |  |                              |   |                         |           |           |                         |          |                         |                         |          |                         |                         |          |                         |                         |          |                         |         |   |                         |      |           |         |   |   |   |  |                              |   |          |                         |           |          |                         |                         |          |                         |                         |   |          |                         |   |          |                         |   |          |                         |   |  |         |

T1A/E



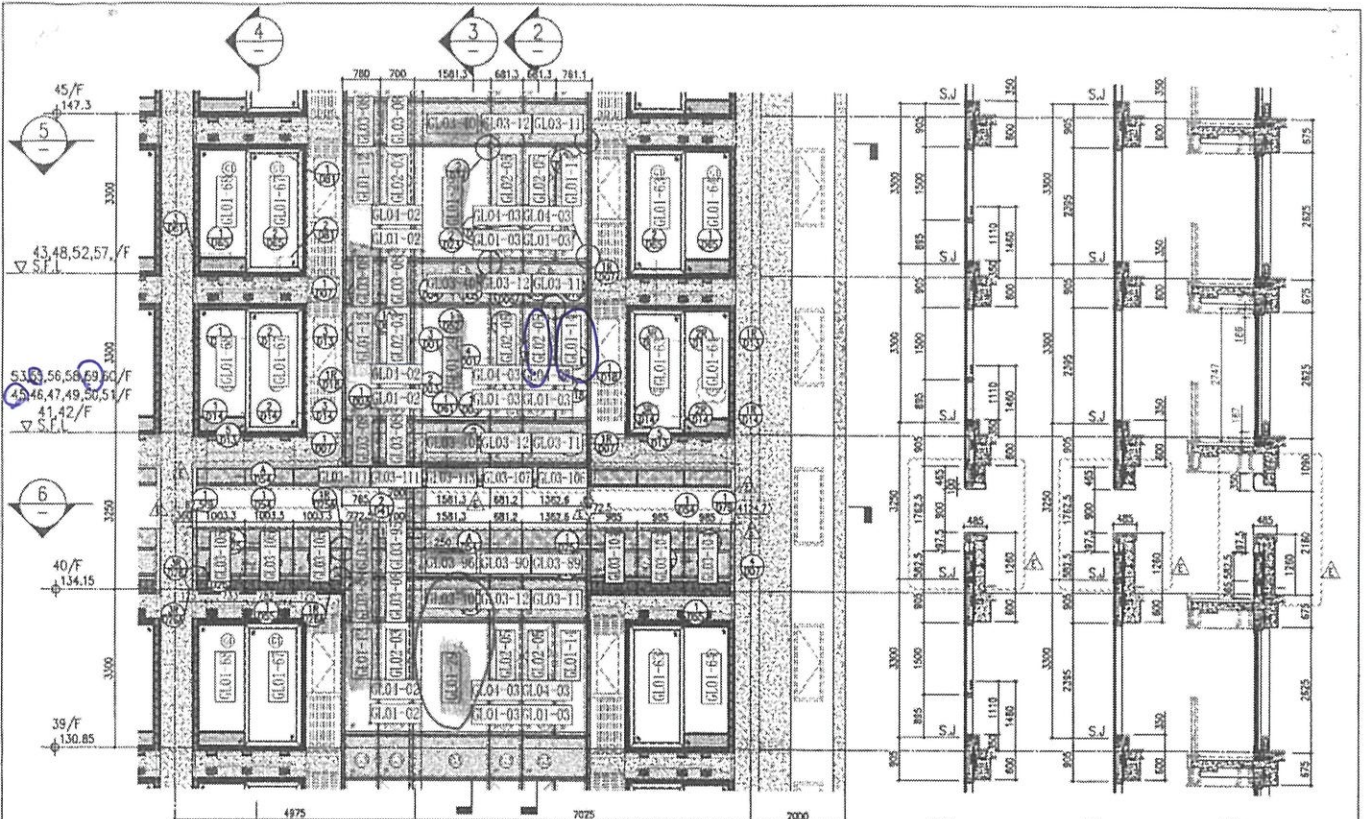

6L01-29 6L01-14  
 PART ELEVATION FOR CURTAIN WALL  
 59AC 55AC

45AC  
 TIA

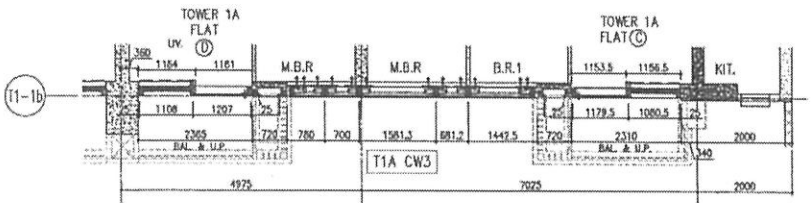

5 PART PLAN FOR CURTAIN WALL

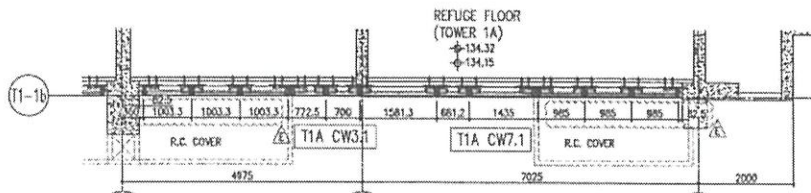

6 PART PLAN FOR CURTAIN WALL

|             |              |              |              |
|-------------|--------------|--------------|--------------|
| 26/F +91.25 | 39/F +130.85 | 52/F +170.40 |              |
| 25/F +87.85 | 38/F +127.55 | 51/F +167.10 | R/F +203.80  |
| 23/F +84.65 | 37/F +124.25 | 50/F +163.80 | 62/F +200.30 |
| 22/F +81.35 | 36/F +120.95 | 49/F +160.50 | 61/F +196.80 |
| 21/F +78.05 | 35/F +117.65 | 48/F +157.20 | 60/F +193.50 |
| 20/F +74.75 | 33/F +114.35 | 47/F +153.90 | 59/F +190.20 |
| 19/F +71.45 | 32/F +111.05 | 46/F +150.60 | 58/F +186.90 |
| 18/F +68.15 | 31/F 107.75  | 45/F +147.30 | 57/F +183.60 |
| 17/F +64.85 | 30/F +104.45 | 43/F +144.00 | 56/F +180.30 |
| 16/F +61.55 | 29/F +101.15 | 42/F +140.70 | 55/F +177.00 |
| 15/F +58.25 | 28/F +97.85  | 41/F +137.40 | 53/F +173.70 |
| 12/F +54.95 | 27/F +94.55  | 40/F +134.15 |              |

LEGEND:

- 10mm THK. HEAT STRENGTHENED GLASS (OUTSIDE) + 12mm AIR SPACE + 12mm THK. TEMPERED GLASS
- 10mm THK. HEAT STRENGTHENED GLASS (OUTSIDE) + 12mm AIR SPACE + 10mm THK. TEMPERED GLASS
- 12mm THK. HEAT STRENGTHENED GLASS
- 12mm THK. CLEAR TEMPERED GLASS (INTERNAL PROTECTIVE BARRIER)
- 10mm BLUE TINTED HEAT STRENGTHENED GLASS
- 10mm THK. CLEAR TEMPERED GLASS
- 8mm THK. CLEAR HEAT-STRENGTHENED GLASS + 12mm AIR SPACE + 8mm THK. CLEAR HEAT-STRENGTHENED GLASS
- 3mm THK. ALUM. CLADDING
- 3mm THK. ALUM. BACKPAN
- STACK JOINT

|  |  |  |
|--|--|--|
| <p>DATE: 22-01-21</p> <p>SCALE: 1:50(A1)</p> <p>TITLE: TYPICAL FLOOR PARTIAL ELEVATION &amp; SECTION, PLAN FOR CURTAIN WALL (TOWER 1)</p> <p>PROJECT: PROPOSED RESIDENTIAL DEVELOPMENT AT TOWER 1, LEONGS PAW TOWER KIAN O, N.T.</p> <p>CLIENT: 信和置業有限公司<br/>Sino Land Company Limited</p> | <p>ARCHITECT: Ronald Lu &amp; Partners (HK) Ltd.<br/>信和建築師事務所 (香港) 有限公司</p> <p>STRUCTURAL ENGINEER: Gammorn</p> <p>ENGINEER: AECOM</p> <p>CONTRACTOR: 信和置業有限公司<br/>Sino Land Company Limited</p> | <p>NO. OF SHEETS: 1</p> <p>SHEET NO.: 1</p> <p>DATE: 22-01-21</p> <p>SCALE: 1:50(A1)</p> <p>TITLE: TYPICAL FLOOR PARTIAL ELEVATION &amp; SECTION, PLAN FOR CURTAIN WALL (TOWER 1)</p> <p>PROJECT: PROPOSED RESIDENTIAL DEVELOPMENT AT TOWER 1, LEONGS PAW TOWER KIAN O, N.T.</p> <p>CLIENT: 信和置業有限公司<br/>Sino Land Company Limited</p> |
|--|--|--|