

工程指示 / 要求簡箋(E.I.)

工程指示編號：EI / 8974 / 25 修改版次：

工程編號：J - 858

工程名稱：將軍澳日出康城

工程項目：幕牆 第3次 補玻璃 23 件 (小業主單)

收件人：Maggie

發件人：Jason

日期：04/06/2025

要求提供 / 確認 事項：

- |                                    |                                     |                               |
|------------------------------------|-------------------------------------|-------------------------------|
| <input type="checkbox"/> 初步鋁料 B.M. | <input type="checkbox"/> 加工拆圖，然後生產  | <input type="checkbox"/> 尺寸表  |
| <input type="checkbox"/> 正式鋁料 B.M. | <input type="checkbox"/> 技術上資料 / 指示 | <input type="checkbox"/> 報價   |
| <input type="checkbox"/> 配件 B.M.   | <input type="checkbox"/> 樣辦或貨品說明書   | <input type="checkbox"/> 分判合約 |

內容：

由於地盤需要更換玻璃，請按玻璃 BM 生產玻璃，共 23 件 送地盤。

請安排熱浸

1. 不要印上熱浸標籤。只給”可移除”的標籤。
2. 依原 EI 4867, EI 4943, EI 4942 尺寸補，
3. \*\*\*\*\*分座包箱， 玻璃標籤請註明樓層、單位。\*\*\*\*\* 請留意。
4. 第一次補 25 件 EI8938; 第 2 次補 35 件 EI8952; 第 3 次補 23 件本次;
5. 地盆：更換幕牆玻璃，需用吊船。
6. 按芳姐 二寶 資料

謝謝

請在 2025.07.03 前完成上列要求。

分發東莞各部門：

- |                                 |                              |                                |                              |                               |                              |                                   |                              |
|---------------------------------|------------------------------|--------------------------------|------------------------------|-------------------------------|------------------------------|-----------------------------------|------------------------------|
| <input type="checkbox"/> 生產技術總監 | <input type="checkbox"/> 連附件 | <input type="checkbox"/> 技術部   | <input type="checkbox"/> 連附件 | <input type="checkbox"/> 生產部  | <input type="checkbox"/> 連附件 | <input type="checkbox"/> 機械設計部    | <input type="checkbox"/> 連附件 |
| <input type="checkbox"/> 採購部    | <input type="checkbox"/> 連附件 | <input type="checkbox"/> 生產統籌部 | <input type="checkbox"/> 連附件 | <input type="checkbox"/> 小羅&清 | <input type="checkbox"/> 連附件 |                                   |                              |
| <input type="checkbox"/> 質檢部    | <input type="checkbox"/> 連附件 | <input type="checkbox"/> 會計部   | <input type="checkbox"/> 連附件 | <input type="checkbox"/> 報關組  | <input type="checkbox"/> 連附件 | <input type="checkbox"/> 其他 _____ | <input type="checkbox"/> 連附件 |

分發香港各部門：

- |   |   |                               |                              |                              |                              |  |   |
|---|---|-------------------------------|------------------------------|------------------------------|------------------------------|--|---|
| <input type="checkbox"/> 行政部            | <input type="checkbox"/> 連附件            | <input type="checkbox"/> 會計部  | <input type="checkbox"/> 連附件 | <input type="checkbox"/> 統籌部 | <input type="checkbox"/> 連附件 | <input checked="" type="checkbox"/> 工程部地盤科文 二寶 | <input checked="" type="checkbox"/> 連附件 |
| <input checked="" type="checkbox"/> 採購部 | <input checked="" type="checkbox"/> 連附件 | <input type="checkbox"/> QS 部 | <input type="checkbox"/> 連附件 | <input type="checkbox"/> 維修部 | <input type="checkbox"/> 連附件 | <input type="checkbox"/> 其他 _____              | <input type="checkbox"/> 連附件            |

傳遞編號：

HK

/ 25

發件人簽署：

項目經理簽署：

序號	EI	3/6小業主單	項目	座	樓層	單位	件數	玻璃編號	W (mm)	H (mm)	厚度 (mm)	Letter
124	E8974	3/6小業主單	CW	T2	12/F	AB	1	GL01-12	663	2332	10mm THK, HEAT STRENGTHEN GLASS (OUTSIDE) W/ LOW-E COATING ON SURFACE (AIR SPACE - 12mm AIR SPACE - 12mm THK, CLEAR TEMPERED GLASS(INSIDE)) (U: (E2022014001))	
125	E8974	3/6小業主單	CW	T1	49/F	BD	1	GL01-02	663	832	10mm THK, HEAT STRENGTHEN GLASS (OUTSIDE) W/ LOW-E COATING ON SURFACE (AIR SPACE - 12mm AIR SPACE - 12mm THK, CLEAR TEMPERED GLASS(INSIDE)) (U: (E2022014001))	
126	E8974	3/6小業主單	CW	T1	49/F	BA	1	GL01-03	644	832	10mm THK, HEAT STRENGTHEN GLASS (OUTSIDE) W/ LOW-E COATING ON SURFACE (AIR SPACE - 12mm AIR SPACE - 12mm THK, CLEAR TEMPERED GLASS(INSIDE)) (U: (E2022014001))	
127	E8974	3/6小業主單	CW	T1	43/F	BB	1	GL01-17	585.5	2332	10mm THK, HEAT STRENGTHEN GLASS (OUTSIDE) W/ LOW-E COATING ON SURFACE (AIR SPACE - 12mm AIR SPACE - 12mm THK, CLEAR TEMPERED GLASS(INSIDE)) (U: (E2022014001))	
128	E8974	3/6小業主單	CW	T1	41/F	BA	1	GL02-05	636	1443	10mm THK, HEAT STRENGTHEN GLASS (OUTSIDE) W/ LOW-E COATING ON SURFACE (AIR SPACE - 12mm AIR SPACE - 12mm THK, CLEAR TEMPERED GLASS(INSIDE)) (U: (E2022014001))	
129	E8974	3/6小業主單	CW	T1	39/F	BC	1	GL02-05	636	1443	10mm THK, HEAT STRENGTHEN GLASS (OUTSIDE) W/ LOW-E COATING ON SURFACE (AIR SPACE - 12mm AIR SPACE - 12mm THK, CLEAR TEMPERED GLASS(INSIDE)) (U: (E2022014001))	
130	E8974	3/6小業主單	CW	T1	33/F	AD	1	GL01-02	663	832	10mm THK, HEAT STRENGTHEN GLASS (OUTSIDE) W/ LOW-E COATING ON SURFACE (AIR SPACE - 12mm AIR SPACE - 12mm THK, CLEAR TEMPERED GLASS(INSIDE)) (U: (E2022014001))	
131	E8974	3/6小業主單	CW	T1	32/F	AA	1	GL01-15	1272	2332	10mm THK, HEAT STRENGTHEN GLASS (OUTSIDE) W/ LOW-E COATING ON SURFACE (AIR SPACE - 12mm AIR SPACE - 12mm THK, CLEAR TEMPERED GLASS(INSIDE)) (U: (E2022014001))	
132	E8974	3/6小業主單	CW	T1	32/F	AA	1	GL01-14	644	2332	10mm THK, HEAT STRENGTHEN GLASS (OUTSIDE) W/ LOW-E COATING ON SURFACE (AIR SPACE - 12mm AIR SPACE - 12mm THK, CLEAR TEMPERED GLASS(INSIDE)) (U: (E2022014001))	
133	E8974	3/6小業主單	CW	T1	28/F	AC	1	GL01-29	1544	2332	10mm THK, HEAT STRENGTHEN GLASS (OUTSIDE) W/ LOW-E COATING ON SURFACE (AIR SPACE - 12mm AIR SPACE - 12mm THK, CLEAR TEMPERED GLASS(INSIDE)) (U: (E2022014001))	
134	E8974	3/6小業主單	CW	T1	28/F	AC	1	GL01-03	644	832	10mm THK, HEAT STRENGTHEN GLASS (OUTSIDE) W/ LOW-E COATING ON SURFACE (AIR SPACE - 12mm AIR SPACE - 12mm THK, CLEAR TEMPERED GLASS(INSIDE)) (U: (E2022014001))	
135	E8974	3/6小業主單	CW	T1	28/F	AC	1	GL02-05	636	1443	10mm THK, HEAT STRENGTHEN GLASS (OUTSIDE) W/ LOW-E COATING ON SURFACE (AIR SPACE - 12mm AIR SPACE - 12mm THK, CLEAR TEMPERED GLASS(INSIDE)) (U: (E2022014001))	
136	E8974	3/6小業主單	CW	T1	27/F	AE	1	GL02-08	655.5	1443	10mm THK, HEAT STRENGTHEN GLASS (OUTSIDE) W/ LOW-E COATING ON SURFACE (AIR SPACE - 12mm AIR SPACE - 12mm THK, CLEAR TEMPERED GLASS(INSIDE)) (U: (E2022014001))	
137	E8974	3/6小業主單	CW	T1	25/F	BD	1	GL01-24	1751	2332	10mm THK, HEAT STRENGTHEN GLASS (OUTSIDE) W/ LOW-E COATING ON SURFACE (AIR SPACE - 12mm AIR SPACE - 12mm THK, CLEAR TEMPERED GLASS(INSIDE)) (U: (E2022014001))	
138	E8974	3/6小業主單	CW	T1	20/F	BB	1	GL02-07	585	1443	10mm THK, HEAT STRENGTHEN GLASS (OUTSIDE) W/ LOW-E COATING ON SURFACE (AIR SPACE - 12mm AIR SPACE - 12mm THK, CLEAR TEMPERED GLASS(INSIDE)) (U: (E2022014001))	
139	E8974	3/6小業主單	CW	T1	19/F	AF	1	GL02-05	636	1443	10mm THK, HEAT STRENGTHEN GLASS (OUTSIDE) W/ LOW-E COATING ON SURFACE (AIR SPACE - 12mm AIR SPACE - 12mm THK, CLEAR TEMPERED GLASS(INSIDE)) (U: (E2022014001))	
140	E8974	3/6小業主單	CW	T1	19/F	AF	1	GL01-03	644	832	10mm THK, HEAT STRENGTHEN GLASS (OUTSIDE) W/ LOW-E COATING ON SURFACE (AIR SPACE - 12mm AIR SPACE - 12mm THK, CLEAR TEMPERED GLASS(INSIDE)) (U: (E2022014001))	
141	E8974	3/6小業主單	CW	T1	19/F	AF	1	GL01-14	644	2332	10mm THK, HEAT STRENGTHEN GLASS (OUTSIDE) W/ LOW-E COATING ON SURFACE (AIR SPACE - 12mm AIR SPACE - 12mm THK, CLEAR TEMPERED GLASS(INSIDE)) (U: (E2022014001))	
142	E8974	3/6小業主單	CW	T1	18/F	BE	1	GL01-17	585.5	2332	10mm THK, HEAT STRENGTHEN GLASS (OUTSIDE) W/ LOW-E COATING ON SURFACE (AIR SPACE - 12mm AIR SPACE - 12mm THK, CLEAR TEMPERED GLASS(INSIDE)) (U: (E2022014001))	
143	E8974	3/6小業主單	CW	T1	18/F	AC	1	GL02-05	636	1443	10mm THK, HEAT STRENGTHEN GLASS (OUTSIDE) W/ LOW-E COATING ON SURFACE (AIR SPACE - 12mm AIR SPACE - 12mm THK, CLEAR TEMPERED GLASS(INSIDE)) (U: (E2022014001))	
144	E8974	3/6小業主單	CW	T1	17/F	AE	1	GL01-27	1660	2332	10mm THK, HEAT STRENGTHEN GLASS (OUTSIDE) W/ LOW-E COATING ON SURFACE (AIR SPACE - 12mm AIR SPACE - 12mm THK, CLEAR TEMPERED GLASS(INSIDE)) (U: (E2022014001))	
145	E8974	3/6小業主單	CW	T1	17/F	AE	1	GL02-05	636	1443	10mm THK, HEAT STRENGTHEN GLASS (OUTSIDE) W/ LOW-E COATING ON SURFACE (AIR SPACE - 12mm AIR SPACE - 12mm THK, CLEAR TEMPERED GLASS(INSIDE)) (U: (E2022014001))	
146	E8974	3/6小業主單	CW	T1	17/F	BD	1	GL01-24	1751	2332	10mm THK, HEAT STRENGTHEN GLASS (OUTSIDE) W/ LOW-E COATING ON SURFACE (AIR SPACE - 12mm AIR SPACE - 12mm THK, CLEAR TEMPERED GLASS(INSIDE)) (U: (E2022014001))	
						補玻璃總數		23				
			=			10mm THK, HEAT STRENGTHEN GLASS (OUTSIDE) W/ LOW-E COATING ON SURFACE 58T #/2 + 12 mm AIR SPACE - 12mm THK, CLEAR TEMPERED GLASS(INSIDE) ICU (R:20220114001)						
			=			10mm THK, HEAT STRENGTHEN GLASS (OUTSIDE) W/ LOW-E COATING ON SURFACE 58T #/2 + 12 mm AIR SPACE - 10mm THK, CLEAR TEMPERED GLASS(INSIDE) ICU (R:20220114003)						
			=			12mm THK, HEAT STRENGTHEN GLASS, Reflective Glass SSC1-60T (R:20220324054)						

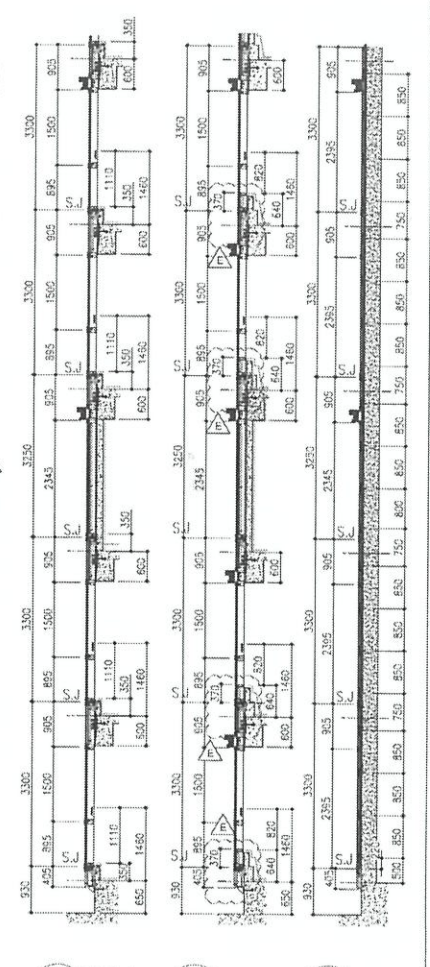
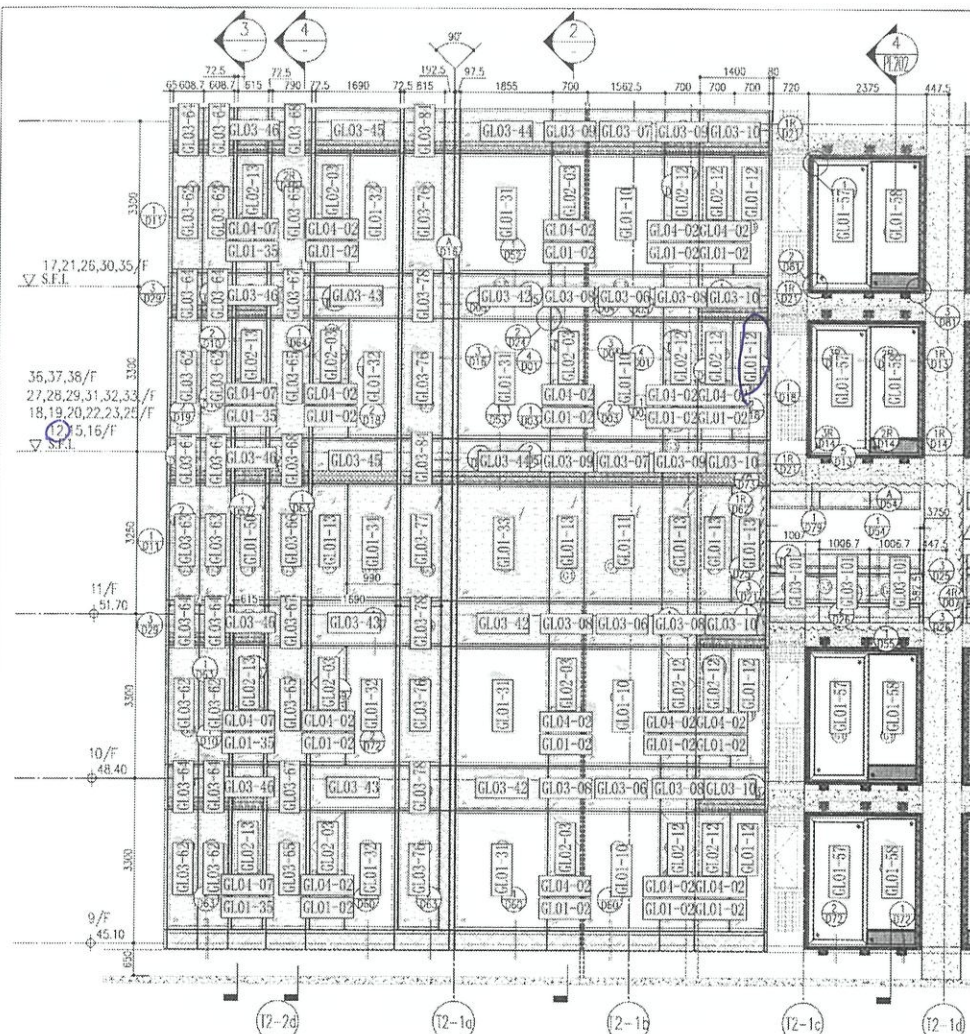

1 PART ELEVATION FOR CURTAIN WALL

T2 12AB  
GLO1-12

ARCH. FEATURE AT 9/F, 10/F, 12/F, 15/F-16/F, 18/F-20/F, 22/F, 23/F, 25/F, 27/F-29/F, 31/F-33/F, 36/F-38/F

ARCH. FEATURE AT 11/F, 17/F, 21/F, 26/F, 30/F, 35/F

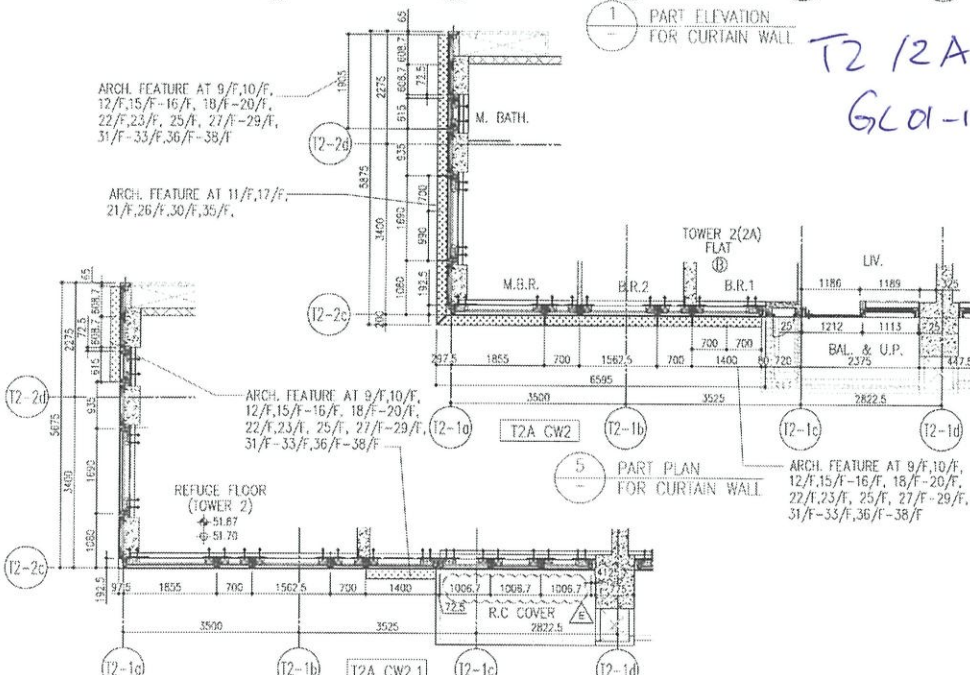

5 PART PLAN FOR CURTAIN WALL

6 PART PLAN (11/F) FOR CURTAIN WALL

R/F	+217.00	+213.50	+210.00	+206.70	+203.40	+200.10	+196.80	+193.50	+190.20	+186.90	+183.60	+180.30	+177.00	+173.70
26/F	+91.25	39/F	+130.85	52/F	+170.40	65/F	+210.00							
25/F	+87.95	38/F	+127.55	51/F	+167.10	64/F	+206.70							
23/F	+84.65	37/F	+124.25	50/F	+163.80	63/F	+203.40							
22/F	+81.35	36/F	+120.95	49/F	+160.50	62/F	+200.10							
21/F	+78.05	35/F	+117.65	48/F	+157.20	61/F	+196.80							
20/F	+74.75	33/F	+114.35	47/F	+153.90	60/F	+193.50							
19/F	+71.45	32/F	+111.05	46/F	+150.60	59/F	+190.20							
18/F	+68.15	31/F	+107.75	45/F	+147.30	58/F	+186.90							
17/F	+64.85	30/F	+104.45	43/F	+144.00	57/F	+183.60							
16/F	+61.55	29/F	+101.15	42/F	+140.70	56/F	+180.30							
15/F	+58.25	28/F	+97.85	41/F	+137.40	55/F	+177.00							
12/F	+54.95	27/F	+94.55	40/F	+134.15	53/F	+173.70							

- LEGEND:
- 10mm THK HEAT STRENGTHENED GLASS (OUTSIDE) + 12mm AIR SPACE + 12mm THK TEMPERED GLASS
  - 10mm THK HEAT STRENGTHENED GLASS (OUTSIDE) + 12mm AIR SPACE + 10mm THK TEMPERED GLASS
  - 12mm THK HEAT STRENGTHENED GLASS
  - 12mm THK CLEAR TEMPERED GLASS (INTERNAL PROTECTIVE BARRIER)
  - 10mm BELETED HEAT STRENGTHENED GLASS
  - 10mm CLEAR TEMPERED GLASS
  - 8mm THK CLEAR HEAT-STRENGTHENED GLASS + 2mm PVB + 8mm THK CLEAR HEAT STRENGTHENED GLASS
  - 3mm THK ALUM. CLADDING
  - 3mm THK ALUM BACKPAN
  - STACK JOINT

<p>DATE: 20-07-21 SCALE: 1:50(A)</p> <p>DESIGNED BY: [Name] CHECKED BY: [Name]</p> <p>PROJECT: PROPOSED RESIDENTIAL DEVELOPMENT AT 'TOWER 1', PHASE '1', CONNS PARK, ISHONG KWAN O, N.T.</p> <p>TITLE: TYPICAL FLOOR PARTIAL ELEVATION &amp; SECTION PLAN FOR CURTAIN WALL (TOWER 2)</p> <p>PROJECT NO.: J-888</p> <p>PROJ. NO.: [Number]</p> <p>REV. NO.: [Number]</p> <p>REV. 1: [Description]</p> <p>REV. 2: [Description]</p> <p>REV. 3: [Description]</p>	<p>REVISIONS:</p> <table border="1"> <tr> <th>NO.</th> <th>DATE</th> <th>DESCRIPTION</th> </tr> <tr> <td>1</td> <td></td> <td>ISSUED FOR PERMITS</td> </tr> <tr> <td>2</td> <td></td> <td>ISSUED FOR PERMITS</td> </tr> <tr> <td>3</td> <td></td> <td>ISSUED FOR PERMITS</td> </tr> </table>	NO.	DATE	DESCRIPTION	1		ISSUED FOR PERMITS	2		ISSUED FOR PERMITS	3		ISSUED FOR PERMITS	<p>SCALE: 1:50(A)</p> <p>DATE: 20-07-21</p> <p>PROJECT: PROPOSED RESIDENTIAL DEVELOPMENT AT 'TOWER 1', PHASE '1', CONNS PARK, ISHONG KWAN O, N.T.</p>	<p>PROJECT NO.: J-888</p> <p>PROJ. NO.: [Number]</p> <p>REV. NO.: [Number]</p> <p>REV. 1: [Description]</p> <p>REV. 2: [Description]</p> <p>REV. 3: [Description]</p>	<p>REVISIONS:</p> <table border="1"> <tr> <th>NO.</th> <th>DATE</th> <th>DESCRIPTION</th> </tr> <tr> <td>1</td> <td></td> <td>ISSUED FOR PERMITS</td> </tr> <tr> <td>2</td> <td></td> <td>ISSUED FOR PERMITS</td> </tr> <tr> <td>3</td> <td></td> <td>ISSUED FOR PERMITS</td> </tr> </table>	NO.	DATE	DESCRIPTION	1		ISSUED FOR PERMITS	2		ISSUED FOR PERMITS	3		ISSUED FOR PERMITS	<p>REVISIONS:</p> <table border="1"> <tr> <th>NO.</th> <th>DATE</th> <th>DESCRIPTION</th> </tr> <tr> <td>1</td> <td></td> <td>ISSUED FOR PERMITS</td> </tr> <tr> <td>2</td> <td></td> <td>ISSUED FOR PERMITS</td> </tr> <tr> <td>3</td> <td></td> <td>ISSUED FOR PERMITS</td> </tr> </table>	NO.	DATE	DESCRIPTION	1		ISSUED FOR PERMITS	2		ISSUED FOR PERMITS	3		ISSUED FOR PERMITS	<p>REVISIONS:</p> <table border="1"> <tr> <th>NO.</th> <th>DATE</th> <th>DESCRIPTION</th> </tr> <tr> <td>1</td> <td></td> <td>ISSUED FOR PERMITS</td> </tr> <tr> <td>2</td> <td></td> <td>ISSUED FOR PERMITS</td> </tr> <tr> <td>3</td> <td></td> <td>ISSUED FOR PERMITS</td> </tr> </table>	NO.	DATE	DESCRIPTION	1		ISSUED FOR PERMITS	2		ISSUED FOR PERMITS	3		ISSUED FOR PERMITS	<p>REVISIONS:</p> <table border="1"> <tr> <th>NO.</th> <th>DATE</th> <th>DESCRIPTION</th> </tr> <tr> <td>1</td> <td></td> <td>ISSUED FOR PERMITS</td> </tr> <tr> <td>2</td> <td></td> <td>ISSUED FOR PERMITS</td> </tr> <tr> <td>3</td> <td></td> <td>ISSUED FOR PERMITS</td> </tr> </table>	NO.	DATE	DESCRIPTION	1		ISSUED FOR PERMITS	2		ISSUED FOR PERMITS	3		ISSUED FOR PERMITS	<p>REVISIONS:</p> <table border="1"> <tr> <th>NO.</th> <th>DATE</th> <th>DESCRIPTION</th> </tr> <tr> <td>1</td> <td></td> <td>ISSUED FOR PERMITS</td> </tr> <tr> <td>2</td> <td></td> <td>ISSUED FOR PERMITS</td> </tr> <tr> <td>3</td> <td></td> <td>ISSUED FOR PERMITS</td> </tr> </table>	NO.	DATE	DESCRIPTION	1		ISSUED FOR PERMITS	2		ISSUED FOR PERMITS	3		ISSUED FOR PERMITS	<p>REVISIONS:</p> <table border="1"> <tr> <th>NO.</th> <th>DATE</th> <th>DESCRIPTION</th> </tr> <tr> <td>1</td> <td></td> <td>ISSUED FOR PERMITS</td> </tr> <tr> <td>2</td> <td></td> <td>ISSUED FOR PERMITS</td> </tr> <tr> <td>3</td> <td></td> <td>ISSUED FOR PERMITS</td> </tr> </table>	NO.	DATE	DESCRIPTION	1		ISSUED FOR PERMITS	2		ISSUED FOR PERMITS	3		ISSUED FOR PERMITS	<p>REVISIONS:</p> <table border="1"> <tr> <th>NO.</th> <th>DATE</th> <th>DESCRIPTION</th> </tr> <tr> <td>1</td> <td></td> <td>ISSUED FOR PERMITS</td> </tr> <tr> <td>2</td> <td></td> <td>ISSUED FOR PERMITS</td> </tr> <tr> <td>3</td> <td></td> <td>ISSUED FOR PERMITS</td> </tr> </table>	NO.	DATE	DESCRIPTION	1		ISSUED FOR PERMITS	2		ISSUED FOR PERMITS	3		ISSUED FOR PERMITS	<p>REVISIONS:</p> <table border="1"> <tr> <th>NO.</th> <th>DATE</th> <th>DESCRIPTION</th> </tr> <tr> <td>1</td> <td></td> <td>ISSUED FOR PERMITS</td> </tr> <tr> <td>2</td> <td></td> <td>ISSUED FOR PERMITS</td> </tr> <tr> <td>3</td> <td></td> <td>ISSUED FOR PERMITS</td> </tr> </table>	NO.	DATE	DESCRIPTION	1		ISSUED FOR PERMITS	2		ISSUED FOR PERMITS	3		ISSUED FOR PERMITS	<p>REVISIONS:</p> <table border="1"> <tr> <th>NO.</th> <th>DATE</th> <th>DESCRIPTION</th> </tr> <tr> <td>1</td> <td></td> <td>ISSUED FOR PERMITS</td> </tr> <tr> <td>2</td> <td></td> <td>ISSUED FOR PERMITS</td> </tr> <tr> <td>3</td> <td></td> <td>ISSUED FOR PERMITS</td> </tr> </table>	NO.	DATE	DESCRIPTION	1		ISSUED FOR PERMITS	2		ISSUED FOR PERMITS	3		ISSUED FOR PERMITS	<p>REVISIONS:</p> <table border="1"> <tr> <th>NO.</th> <th>DATE</th> <th>DESCRIPTION</th> </tr> <tr> <td>1</td> <td></td> <td>ISSUED FOR PERMITS</td> </tr> <tr> <td>2</td> <td></td> <td>ISSUED FOR PERMITS</td> </tr> <tr> <td>3</td> <td></td> <td>ISSUED FOR PERMITS</td> </tr> </table>	NO.	DATE	DESCRIPTION	1		ISSUED FOR PERMITS	2		ISSUED FOR PERMITS	3		ISSUED FOR PERMITS	<p>REVISIONS:</p> <table border="1"> <tr> <th>NO.</th> <th>DATE</th> <th>DESCRIPTION</th> </tr> <tr> <td>1</td> <td></td> <td>ISSUED FOR PERMITS</td> </tr> <tr> <td>2</td> <td></td> <td>ISSUED FOR PERMITS</td> </tr> <tr> <td>3</td> <td></td> <td>ISSUED FOR PERMITS</td> </tr> </table>	NO.	DATE	DESCRIPTION	1		ISSUED FOR PERMITS	2		ISSUED FOR PERMITS	3		ISSUED FOR PERMITS	<p>REVISIONS:</p> <table border="1"> <tr> <th>NO.</th> <th>DATE</th> <th>DESCRIPTION</th> </tr> <tr> <td>1</td> <td></td> <td>ISSUED FOR PERMITS</td> </tr> <tr> <td>2</td> <td></td> <td>ISSUED FOR PERMITS</td> </tr> <tr> <td>3</td> <td></td> <td>ISSUED FOR PERMITS</td> </tr> </table>	NO.	DATE	DESCRIPTION	1		ISSUED FOR PERMITS	2		ISSUED FOR PERMITS	3		ISSUED FOR PERMITS	<p>REVISIONS:</p> <table border="1"> <tr> <th>NO.</th> <th>DATE</th> <th>DESCRIPTION</th> </tr> <tr> <td>1</td> <td></td> <td>ISSUED FOR PERMITS</td> </tr> <tr> <td>2</td> <td></td> <td>ISSUED FOR PERMITS</td> </tr> <tr> <td>3</td> <td></td> <td>ISSUED FOR PERMITS</td> </tr> </table>	NO.	DATE	DESCRIPTION	1		ISSUED FOR PERMITS	2		ISSUED FOR PERMITS	3		ISSUED FOR PERMITS	<p>REVISIONS:</p> <table border="1"> <tr> <th>NO.</th> <th>DATE</th> <th>DESCRIPTION</th> </tr> <tr> <td>1</td> <td></td> <td>ISSUED FOR PERMITS</td> </tr> <tr> <td>2</td> <td></td> <td>ISSUED FOR PERMITS</td> </tr> <tr> <td>3</td> <td></td> <td>ISSUED FOR PERMITS</td> </tr> </table>	NO.	DATE	DESCRIPTION	1		ISSUED FOR PERMITS	2		ISSUED FOR PERMITS	3		ISSUED FOR PERMITS	<p>REVISIONS:</p> <table border="1"> <tr> <th>NO.</th> <th>DATE</th> <th>DESCRIPTION</th> </tr> <tr> <td>1</td> <td></td> <td>ISSUED FOR PERMITS</td> </tr> <tr> <td>2</td> <td></td> <td>ISSUED FOR PERMITS</td> </tr> <tr> <td>3</td> <td></td> <td>ISSUED FOR PERMITS</td> </tr> </table>	NO.	DATE	DESCRIPTION	1		ISSUED FOR PERMITS	2		ISSUED FOR PERMITS	3		ISSUED FOR PERMITS	<p>REVISIONS:</p> <table border="1"> <tr> <th>NO.</th> <th>DATE</th> <th>DESCRIPTION</th> </tr> <tr> <td>1</td> <td></td> <td>ISSUED FOR PERMITS</td> </tr> <tr> <td>2</td> <td></td> <td>ISSUED FOR PERMITS</td> </tr> <tr> <td>3</td> <td></td> <td>ISSUED FOR PERMITS</td> </tr> </table>	NO.	DATE	DESCRIPTION	1		ISSUED FOR PERMITS	2		ISSUED FOR PERMITS	3		ISSUED FOR PERMITS	<p>REVISIONS:</p> <table border="1"> <tr> <th>NO.</th> <th>DATE</th> <th>DESCRIPTION</th> </tr> <tr> <td>1</td> <td></td> <td>ISSUED FOR PERMITS</td> </tr> <tr> <td>2</td> <td></td> <td>ISSUED FOR PERMITS</td> </tr> <tr> <td>3</td> <td></td> <td>ISSUED FOR PERMITS</td> </tr> </table>	NO.	DATE	DESCRIPTION	1		ISSUED FOR PERMITS	2		ISSUED FOR PERMITS	3		ISSUED FOR PERMITS	<p>REVISIONS:</p> <table border="1"> <tr> <th>NO.</th> <th>DATE</th> <th>DESCRIPTION</th> </tr> <tr> <td>1</td> <td></td> <td>ISSUED FOR PERMITS</td> </tr> <tr> <td>2</td> <td></td> <td>ISSUED FOR PERMITS</td> </tr> <tr> <td>3</td> <td></td> <td>ISSUED FOR PERMITS</td> </tr> </table>	NO.	DATE	DESCRIPTION	1		ISSUED FOR PERMITS	2		ISSUED FOR PERMITS	3		ISSUED FOR PERMITS	<p>REVISIONS:</p> <table border="1"> <tr> <th>NO.</th> <th>DATE</th> <th>DESCRIPTION</th> </tr> <tr> <td>1</td> <td></td> <td>ISSUED FOR PERMITS</td> </tr> <tr> <td>2</td> <td></td> <td>ISSUED FOR PERMITS</td> </tr> <tr> <td>3</td> <td></td> <td>ISSUED FOR PERMITS</td> </tr> </table>	NO.	DATE	DESCRIPTION	1		ISSUED FOR PERMITS	2		ISSUED FOR PERMITS	3		ISSUED FOR PERMITS	<p>REVISIONS:</p> <table border="1"> <tr> <th>NO.</th> <th>DATE</th> <th>DESCRIPTION</th> </tr> <tr> <td>1</td> <td></td> <td>ISSUED FOR PERMITS</td> </tr> <tr> <td>2</td> <td></td> <td>ISSUED FOR PERMITS</td> </tr> <tr> <td>3</td> <td></td> <td>ISSUED FOR PERMITS</td> </tr> </table>	NO.	DATE	DESCRIPTION	1		ISSUED FOR PERMITS	2		ISSUED FOR PERMITS	3		ISSUED FOR PERMITS	<p>REVISIONS:</p> <table border="1"> <tr> <th>NO.</th> <th>DATE</th> <th>DESCRIPTION</th> </tr> <tr> <td>1</td> <td></td> <td>ISSUED FOR PERMITS</td> </tr> <tr> <td>2</td> <td></td> <td>ISSUED FOR PERMITS</td> </tr> <tr> <td>3</td> <td></td> <td>ISSUED FOR PERMITS</td> </tr> </table>	NO.	DATE	DESCRIPTION	1		ISSUED FOR PERMITS	2		ISSUED FOR PERMITS	3		ISSUED FOR PERMITS	<p>REVISIONS:</p> <table border="1"> <tr> <th>NO.</th> <th>DATE</th> <th>DESCRIPTION</th> </tr> <tr> <td>1</td> <td></td> <td>ISSUED FOR PERMITS</td> </tr> <tr> <td>2</td> <td></td> <td>ISSUED FOR PERMITS</td> </tr> <tr> <td>3</td> <td></td> <td>ISSUED FOR PERMITS</td> </tr> </table>	NO.	DATE	DESCRIPTION	1		ISSUED FOR PERMITS	2		ISSUED FOR PERMITS	3		ISSUED FOR PERMITS	<p>REVISIONS:</p> <table border="1"> <tr> <th>NO.</th> <th>DATE</th> <th>DESCRIPTION</th> </tr> <tr> <td>1</td> <td></td> <td>ISSUED FOR PERMITS</td> </tr> <tr> <td>2</td> <td></td> <td>ISSUED FOR PERMITS</td> </tr> <tr> <td>3</td> <td></td> <td>ISSUED FOR PERMITS</td> </tr> </table>	NO.	DATE	DESCRIPTION	1		ISSUED FOR PERMITS	2		ISSUED FOR PERMITS	3		ISSUED FOR PERMITS	<p>REVISIONS:</p> <table border="1"> <tr> <th>NO.</th> <th>DATE</th> <th>DESCRIPTION</th> </tr> <tr> <td>1</td> <td></td> <td>ISSUED FOR PERMITS</td> </tr> <tr> <td>2</td> <td></td> <td>ISSUED FOR PERMITS</td> </tr> <tr> <td>3</td> <td></td> <td>ISSUED FOR PERMITS</td> </tr> </table>	NO.	DATE	DESCRIPTION	1		ISSUED FOR PERMITS	2		ISSUED FOR PERMITS	3		ISSUED FOR PERMITS	<p>REVISIONS:</p> <table border="1"> <tr> <th>NO.</th> <th>DATE</th> <th>DESCRIPTION</th> </tr> <tr> <td>1</td> <td></td> <td>ISSUED FOR PERMITS</td> </tr> <tr> <td>2</td> <td></td> <td>ISSUED FOR PERMITS</td> </tr> <tr> <td>3</td> <td></td> <td>ISSUED FOR PERMITS</td> </tr> </table>	NO.	DATE	DESCRIPTION	1		ISSUED FOR PERMITS	2		ISSUED FOR PERMITS	3		ISSUED FOR PERMITS	<p>REVISIONS:</p> <table border="1"> <tr> <th>NO.</th> <th>DATE</th> <th>DESCRIPTION</th> </tr> <tr> <td>1</td> <td></td> <td>ISSUED FOR PERMITS</td> </tr> <tr> <td>2</td> <td></td> <td>ISSUED FOR PERMITS</td> </tr> <tr> <td>3</td> <td></td> <td>ISSUED FOR PERMITS</td> </tr> </table>	NO.	DATE	DESCRIPTION	1		ISSUED FOR PERMITS	2		ISSUED FOR PERMITS	3		ISSUED FOR PERMITS	<p>REVISIONS:</p> <table border="1"> <tr> <th>NO.</th> <th>DATE</th> <th>DESCRIPTION</th> </tr> <tr> <td>1</td> <td></td> <td>ISSUED FOR PERMITS</td> </tr> <tr> <td>2</td> <td></td> <td>ISSUED FOR PERMITS</td> </tr> <tr> <td>3</td> <td></td> <td>ISSUED FOR PERMITS</td> </tr> </table>	NO.	DATE	DESCRIPTION	1		ISSUED FOR PERMITS	2		ISSUED FOR PERMITS	3		ISSUED FOR PERMITS	<p>REVISIONS:</p> <table border="1"> <tr> <th>NO.</th> <th>DATE</th> <th>DESCRIPTION</th> </tr> <tr> <td>1</td> <td></td> <td>ISSUED FOR PERMITS</td> </tr> <tr> <td>2</td> <td></td> <td>ISSUED FOR PERMITS</td> </tr> <tr> <td>3</td> <td></td> <td>ISSUED FOR PERMITS</td> </tr> </table>	NO.	DATE	DESCRIPTION	1		ISSUED FOR PERMITS	2		ISSUED FOR PERMITS	3		ISSUED FOR PERMITS	<p>REVISIONS:</p> <table border="1"> <tr> <th>NO.</th> <th>DATE</th> <th>DESCRIPTION</th> </tr> <tr> <td>1</td> <td></td> <td>ISSUED FOR PERMITS</td> </tr> <tr> <td>2</td> <td></td> <td>ISSUED FOR PERMITS</td> </tr> <tr> <td>3</td> <td></td> <td>ISSUED FOR PERMITS</td> </tr> </table>	NO.	DATE	DESCRIPTION	1		ISSUED FOR PERMITS	2		ISSUED FOR PERMITS	3		ISSUED FOR PERMITS	<p>REVISIONS:</p> <table border="1"> <tr> <th>NO.</th> <th>DATE</th> <th>DESCRIPTION</th> </tr> <tr> <td>1</td> <td></td> <td>ISSUED FOR PERMITS</td> </tr> <tr> <td>2</td> <td></td> <td>ISSUED FOR PERMITS</td> </tr> <tr> <td>3</td> <td></td> <td>ISSUED FOR PERMITS</td> </tr> </table>	NO.	DATE	DESCRIPTION	1		ISSUED FOR PERMITS	2		ISSUED FOR PERMITS	3		ISSUED FOR PERMITS	<p>REVISIONS:</p> <table border="1"> <tr> <th>NO.</th> <th>DATE</th> <th>DESCRIPTION</th> </tr> <tr> <td>1</td> <td></td> <td>ISSUED FOR PERMITS</td> </tr> <tr> <td>2</td> <td></td> <td>ISSUED FOR PERMITS</td> </tr> <tr> <td>3</td> <td></td> <td>ISSUED FOR PERMITS</td> </tr> </table>	NO.	DATE	DESCRIPTION	1		ISSUED FOR PERMITS	2		ISSUED FOR PERMITS	3		ISSUED FOR PERMITS	<p>REVISIONS:</p> <table border="1"> <tr> <th>NO.</th> <th>DATE</th> <th>DESCRIPTION</th> </tr> <tr> <td>1</td> <td></td> <td>ISSUED FOR PERMITS</td> </tr> <tr> <td>2</td> <td></td> <td>ISSUED FOR PERMITS</td> </tr> <tr> <td>3</td> <td></td> <td>ISSUED FOR PERMITS</td> </tr> </table>	NO.	DATE	DESCRIPTION	1		ISSUED FOR PERMITS	2		ISSUED FOR PERMITS	3		ISSUED FOR PERMITS	<p>REVISIONS:</p> <table border="1"> <tr> <th>NO.</th> <th>DATE</th> <th>DESCRIPTION</th> </tr> <tr> <td>1</td> <td></td> <td>ISSUED FOR PERMITS</td> </tr> <tr> <td>2</td> <td></td> <td>ISSUED FOR PERMITS</td> </tr> <tr> <td>3</td> <td></td> <td>ISSUED FOR PERMITS</td> </tr> </table>	NO.	DATE	DESCRIPTION	1		ISSUED FOR PERMITS	2		ISSUED FOR PERMITS	3		ISSUED FOR PERMITS	<p>REVISIONS:</p> <table border="1"> <tr> <th>NO.</th> <th>DATE</th> <th>DESCRIPTION</th> </tr> <tr> <td>1</td> <td></td> <td>ISSUED FOR PERMITS</td> </tr> <tr> <td>2</td> <td></td> <td>ISSUED FOR PERMITS</td> </tr> <tr> <td>3</td> <td></td> <td>ISSUED FOR PERMITS</td> </tr> </table>	NO.	DATE	DESCRIPTION	1		ISSUED FOR PERMITS	2		ISSUED FOR PERMITS	3		ISSUED FOR PERMITS	<p>REVISIONS:</p> <table border="1"> <tr> <th>NO.</th> <th>DATE</th> <th>DESCRIPTION</th> </tr> <tr> <td>1</td> <td></td> <td>ISSUED FOR PERMITS</td> </tr> <tr> <td>2</td> <td></td> <td>ISSUED FOR PERMITS</td> </tr> <tr> <td>3</td> <td></td> <td>ISSUED FOR PERMITS</td> </tr> </table>	NO.	DATE	DESCRIPTION	1		ISSUED FOR PERMITS	2		ISSUED FOR PERMITS	3		ISSUED FOR PERMITS	<p>REVISIONS:</p> <table border="1"> <tr> <th>NO.</th> <th>DATE</th> <th>DESCRIPTION</th> </tr> <tr> <td>1</td> <td></td> <td>ISSUED FOR PERMITS</td> </tr> <tr> <td>2</td> <td></td> <td>ISSUED FOR PERMITS</td> </tr> <tr> <td>3</td> <td></td> <td>ISSUED FOR PERMITS</td> </tr> </table>	NO.	DATE	DESCRIPTION	1		ISSUED FOR PERMITS	2		ISSUED FOR PERMITS	3		ISSUED FOR PERMITS	<p>REVISIONS:</p> <table border="1"> <tr> <th>NO.</th> <th>DATE</th> <th>DESCRIPTION</th> </tr> <tr> <td>1</td> <td></td> <td>ISSUED FOR PERMITS</td> </tr> <tr> <td>2</td> <td></td> <td>ISSUED FOR PERMITS</td> </tr> <tr> <td>3</td> <td></td> <td>ISSUED FOR PERMITS</td> </tr> </table>	NO.	DATE	DESCRIPTION	1		ISSUED FOR PERMITS	2		ISSUED FOR PERMITS	3		ISSUED FOR PERMITS	<p>REVISIONS:</p> <table border="1"> <tr> <th>NO.</th> <th>DATE</th> <th>DESCRIPTION</th> </tr> <tr> <td>1</td> <td></td> <td>ISSUED FOR PERMITS</td> </tr> <tr> <td>2</td> <td></td> <td>ISSUED FOR PERMITS</td> </tr> <tr> <td>3</td> <td></td> <td>ISSUED FOR PERMITS</td> </tr> </table>	NO.	DATE	DESCRIPTION	1		ISSUED FOR PERMITS	2		ISSUED FOR PERMITS	3		ISSUED FOR PERMITS	<p>REVISIONS:</p> <table border="1"> <tr> <th>NO.</th> <th>DATE</th> <th>DESCRIPTION</th> </tr> <tr> <td>1</td> <td></td> <td>ISSUED FOR PERMITS</td> </tr> <tr> <td>2</td> <td></td> <td>ISSUED FOR PERMITS</td> </tr> <tr> <td>3</td> <td></td> <td>ISSUED FOR PERMITS</td> </tr> </table>	NO.	DATE	DESCRIPTION	1		ISSUED FOR PERMITS	2		ISSUED FOR PERMITS	3		ISSUED FOR PERMITS	<p>REVISIONS:</p> <table border="1"> <tr> <th>NO.</th> <th>DATE</th> <th>DESCRIPTION</th> </tr> <tr> <td>1</td> <td></td> <td>ISSUED FOR PERMITS</td> </tr> <tr> <td>2</td> <td></td> <td>ISSUED FOR PERMITS</td> </tr> <tr> <td>3</td> <td></td> <td>ISSUED FOR PERMITS</td> </tr> </table>	NO.	DATE	DESCRIPTION	1		ISSUED FOR PERMITS	2		ISSUED FOR PERMITS	3		ISSUED FOR PERMITS	<p>REVISIONS:</p> <table border="1"> <tr> <th>NO.</th> <th>DATE</th> <th>DESCRIPTION</th> </tr> <tr> <td>1</td> <td></td> <td>ISSUED FOR PERMITS</td> </tr> <tr> <td>2</td> <td></td> <td>ISSUED FOR PERMITS</td> </tr> <tr> <td>3</td> <td></td> <td>ISSUED FOR PERMITS</td> </tr> </table>	NO.	DATE	DESCRIPTION	1		ISSUED FOR PERMITS	2		ISSUED FOR PERMITS	3		ISSUED FOR PERMITS	<p>REVISIONS:</p> <table border="1"> <tr> <th>NO.</th> <th>DATE</th> <th>DESCRIPTION</th> </tr> <tr> <td>1</td> <td></td> <td>ISSUED FOR PERMITS</td> </tr> <tr> <td>2</td> <td></td> <td>ISSUED FOR PERMITS</td> </tr> <tr> <td>3</td> <td></td> <td>ISSUED FOR PERMITS</td> </tr> </table>	NO.	DATE	DESCRIPTION	1		ISSUED FOR PERMITS	2		ISSUED FOR PERMITS	3		ISSUED FOR PERMITS	<p>REVISIONS:</p> <table border="1"> <tr> <th>NO.</th> <th>DATE</th> <th>DESCRIPTION</th> </tr> <tr> <td>1</td> <td></td> <td>ISSUED FOR PERMITS</td> </tr> <tr> <td>2</td> <td></td> <td>ISSUED FOR PERMITS</td> </tr> <tr> <td>3</td> <td></td> <td>ISSUED FOR PERMITS</td> </tr> </table>	NO.	DATE	DESCRIPTION	1		ISSUED FOR PERMITS	2		ISSUED FOR PERMITS	3		ISSUED FOR PERMITS	<p>REVISIONS:</p> <table border="1"> <tr> <th>NO.</th> <th>DATE</th> <th>DESCRIPTION</th> </tr> <tr> <td>1</td> <td></td> <td>ISSUED FOR PERMITS</td> </tr> <tr> <td>2</td> <td></td> <td>ISSUED FOR PERMITS</td> </tr> <tr> <td>3</td> <td></td> <td>ISSUED FOR PERMITS</td> </tr> </table>	NO.	DATE	DESCRIPTION	1		ISSUED FOR PERMITS	2		ISSUED FOR PERMITS	3		ISSUED FOR PERMITS	<p>REVISIONS:</p> <table border="1"> <tr> <th>NO.</th> <th>DATE</th> <th>DESCRIPTION</th> </tr> <tr> <td>1</td> <td></td> <td>ISSUED FOR PERMITS</td> </tr> <tr> <td>2</td> <td></td> <td>ISSUED FOR PERMITS</td> </tr> <tr> <td>3</td> <td></td> <td>ISSUED FOR PERMITS</td> </tr> </table>	NO.	DATE	DESCRIPTION	1		ISSUED FOR PERMITS	2		ISSUED FOR PERMITS	3		ISSUED FOR PERMITS	<p>REVISIONS:</p> <table border="1"> <tr> <th>NO.</th> <th>DATE</th> <th>DESCRIPTION</th> </tr> <tr> <td>1</td> <td></td> <td>ISSUED FOR PERMITS</td> </tr> <tr> <td>2</td> <td></td> <td>ISSUED FOR PERMITS</td> </tr> <tr> <td>3</td> <td></td> <td>ISSUED FOR PERMITS</td> </tr> </table>	NO.	DATE	DESCRIPTION	1		ISSUED FOR PERMITS	2		ISSUED FOR PERMITS	3		ISSUED FOR PERMITS	<p>REVISIONS:</p> <table border="1"> <tr> <th>NO.</th> <th>DATE</th> <th>DESCRIPTION</th> </tr> <tr> <td>1</td> <td></td> <td>ISSUED FOR PERMITS</td> </tr> <tr> <td>2</td> <td></td> <td>ISSUED FOR PERMITS</td> </tr> <tr> <td>3</td> <td></td> <td>ISSUED FOR PERMITS</td> </tr> </table>	NO.	DATE	DESCRIPTION	1		ISSUED FOR PERMITS	2		ISSUED FOR PERMITS	3		ISSUED FOR PERMITS	<p>REVISIONS:</p> <table border="1"> <tr> <th>NO.</th> <th>DATE</th> <th>DESCRIPTION</th> </tr> <tr> <td>1</td> <td></td> <td>ISSUED FOR PERMITS</td> </tr> <tr> <td>2</td> <td></td> <td>ISSUED FOR PERMITS</td> </tr> <tr> <td>3</td> <td></td> <td>ISSUED FOR PERMITS</td> </tr> </table>	NO.	DATE	DESCRIPTION	1		ISSUED FOR PERMITS	2		ISSUED FOR PERMITS	3		ISSUED FOR PERMITS	<p>REVISIONS:</p> <table border="1"> <tr> <th>NO.</th> <th>DATE</th> <th>DESCRIPTION</th> </tr> <tr> <td>1</td> <td></td> <td>ISSUED FOR PERMITS</td> </tr> <tr> <td>2</td> <td></td> <td>ISSUED FOR PERMITS</td> </tr> <tr> <td>3</td> <td></td> <td>ISSUED FOR PERMITS</td> </tr> </table>	NO.	DATE	DESCRIPTION	1		ISSUED FOR PERMITS	2		ISSUED FOR PERMITS	3		ISSUED FOR PERMITS	<p>REVISIONS:</p> <table border="1"> <tr> <th>NO.</th> <th>DATE</th> <th>DESCRIPTION</th> </tr> <tr> <td>1</td> <td></td> <td>ISSUED FOR PERMITS</td> </tr> <tr> <td>2</td> <td></td> <td>ISSUED FOR PERMITS</td> </tr> <tr> <td>3</td> <td></td> <td>ISSUED FOR PERMITS</td> </tr> </table>	NO.	DATE	DESCRIPTION	1		ISSUED FOR PERMITS	2		ISSUED FOR PERMITS	3		ISSUED FOR PERMITS	<p>REVISIONS:</p> <table border="1"> <tr> <th>NO.</th> <th>DATE</th> <th>DESCRIPTION</th> </tr> <tr> <td>1</td> <td></td> <td>ISSUED FOR PERMITS</td> </tr> <tr> <td>2</td> <td></td> <td>ISSUED FOR PERMITS</td> </tr> <tr> <td>3</td> <td></td> <td>ISSUED FOR PERMITS</td> </tr> </table>	NO.	DATE	DESCRIPTION	1		ISSUED FOR PERMITS	2		ISSUED FOR PERMITS	3		ISSUED FOR PERMITS	<p>REVISIONS:</p> <table border="1"> <tr> <th>NO.</th> <th>DATE</th> <th>DESCRIPTION</th> </tr> <tr> <td>1</td> <td></td> <td>ISSUED FOR PERMITS</td> </tr> <tr> <td>2</td> <td></td> <td>ISSUED FOR PERMITS</td> </tr> <tr> <td>3</td> <td></td> <td>ISSUED FOR PERMITS</td> </tr> </table>	NO.	DATE	DESCRIPTION	1		ISSUED FOR PERMITS	2		ISSUED FOR PERMITS	3		ISSUED FOR PERMITS	<p>REVISIONS:</p> <table border="1"> <tr> <th>NO.</th> <th>DATE</th> <th>DESCRIPTION</th> </tr> <tr> <td>1</td> <td></td> <td>ISSUED FOR PERMITS</td> </tr> <tr> <td>2</td> <td></td> <td>ISSUED FOR PERMITS</td> </tr> <tr> <td>3</td> <td></td> <td>ISSUED FOR PERMITS</td> </tr> </table>	NO.	DATE	DESCRIPTION	1		ISSUED FOR PERMITS	2		ISSUED FOR PERMITS	3		ISSUED FOR PERMITS	<p>REVISIONS:</p> <table border="1"> <tr> <th>NO.</th> <th>DATE</th> <th>DESCRIPTION</th> </tr> <tr> <td>1</td> <td></td> <td>ISSUED FOR PERMITS</td> </tr> <tr> <td>2</td> <td></td> <td>ISSUED FOR PERMITS</td> </tr> <tr> <td>3</td> <td></td> <td>ISSUED FOR PERMITS</td> </tr> </table>	NO.	DATE	DESCRIPTION	1		ISSUED FOR PERMITS	2		ISSUED FOR PERMITS	3		ISSUED FOR PERMITS	<p>REVISIONS:</p> <table border="1"> <tr> <th>NO.</th> <th>DATE</th> <th>DESCRIPTION</th> </tr> <tr> <td>1</td> <td></td> <td>ISSUED FOR PERMITS</td> </tr> <tr> <td>2</td> <td></td> <td>ISSUED FOR PERMITS</td> </tr> <tr> <td>3</td> <td></td> <td>ISSUED FOR PERMITS</td> </tr> </table>	NO.	DATE	DESCRIPTION	1		ISSUED FOR PERMITS	2		ISSUED FOR PERMITS	3		ISSUED FOR PERMITS	<p>REVISIONS:</p> <table border="1"> <tr> <th>NO.</th> <th>DATE</th> <th>DESCRIPTION</th> </tr> <tr> <td>1</td> <td></td> <td>ISSUED FOR PERMITS</td> </tr> <tr> <td>2</td> <td></td> <td>ISSUED FOR PERMITS</td> </tr> <tr> <td>3</td> <td></td> <td>ISSUED FOR PERMITS</td> </tr> </table>	NO.	DATE	DESCRIPTION	1		ISSUED FOR PERMITS	2		ISSUED FOR PERMITS	3		ISSUED FOR PERMITS	<p>REVISIONS:</p> <table border="1"> <tr> <th>NO.</th> <th>DATE</th> <th>DESCRIPTION</th> </tr> <tr> <td>1</td> <td></td> <td>ISSUED FOR PERMITS</td> </tr> <tr> <td>2</td> <td></td> <td>ISSUED FOR PERMITS</td> </tr> <tr> <td>3</td> <td></td> <td>ISSUED FOR PERMITS</td> </tr> </table>	NO.	DATE	DESCRIPTION	1		ISSUED FOR PERMITS	2		ISSUED FOR PERMITS	3		ISSUED FOR PERMITS	<p>REVISIONS:</p> <table border="1"> <tr> <th>NO.</th> <th>DATE</th> <th>DESCRIPTION</th> </tr> <tr> <td>1</td> <td></td> <td>ISSUED FOR PERMITS</td> </tr> <tr> <td>2</td> <td></td> <td>ISSUED FOR PERMITS</td> </tr> <tr> <td>3</td> <td></td> <td>ISSUED FOR PERMITS</td> </tr> </table>	NO.	DATE	DESCRIPTION	1		ISSUED FOR PERMITS	2		ISSUED FOR PERMITS	3		ISSUED FOR PERMITS	<p>REVISIONS:</p> <table border="1"> <tr> <th>NO.</th> <th>DATE</th> <th>DESCRIPTION</th> </tr> <tr> <td>1</td> <td></td> <td>ISSUED FOR PERMITS</td> </tr> <tr> <td>2</td> <td></td> <td>ISSUED FOR PERMITS</td> </tr> <tr> <td>3</td> <td></td> <td>ISSUED FOR PERMITS</td> </tr> </table>	NO.	DATE	DESCRIPTION	1		ISSUED FOR PERMITS	2		ISSUED FOR PERMITS	3		ISSUED FOR PERMITS	<p>REVISIONS:</p> <table border="1"> <tr> <th>NO.</th> <th>DATE</th> <th>DESCRIPTION</th> </tr> <tr> <td>1</td> <td></td> <td>ISSUED FOR PERMITS</td> </tr> <tr> <td>2</td> <td></td> <td>ISSUED FOR PERMITS</td> </tr> <tr> <td>3</td> <td></td> <td>ISSUED FOR PERMITS</td> </tr></table>	NO.	DATE	DESCRIPTION	1		ISSUED FOR PERMITS	2		ISSUED FOR PERMITS	3		ISSUED FOR PERMITS
NO.	DATE	DESCRIPTION																																																																																																																																																																																																																																																																																																																																																																																																																																																																																																																																																																																																																																																																																																																																																																																																																									
1		ISSUED FOR PERMITS																																																																																																																																																																																																																																																																																																																																																																																																																																																																																																																																																																																																																																																																																																																																																																																																																									
2		ISSUED FOR PERMITS																																																																																																																																																																																																																																																																																																																																																																																																																																																																																																																																																																																																																																																																																																																																																																																																																									
3		ISSUED FOR PERMITS																																																																																																																																																																																																																																																																																																																																																																																																																																																																																																																																																																																																																																																																																																																																																																																																																									
NO.	DATE	DESCRIPTION																																																																																																																																																																																																																																																																																																																																																																																																																																																																																																																																																																																																																																																																																																																																																																																																																									
1		ISSUED FOR PERMITS																																																																																																																																																																																																																																																																																																																																																																																																																																																																																																																																																																																																																																																																																																																																																																																																																									
2		ISSUED FOR PERMITS																																																																																																																																																																																																																																																																																																																																																																																																																																																																																																																																																																																																																																																																																																																																																																																																																									
3		ISSUED FOR PERMITS																																																																																																																																																																																																																																																																																																																																																																																																																																																																																																																																																																																																																																																																																																																																																																																																																									
NO.	DATE	DESCRIPTION																																																																																																																																																																																																																																																																																																																																																																																																																																																																																																																																																																																																																																																																																																																																																																																																																									
1		ISSUED FOR PERMITS																																																																																																																																																																																																																																																																																																																																																																																																																																																																																																																																																																																																																																																																																																																																																																																																																									
2		ISSUED FOR PERMITS																																																																																																																																																																																																																																																																																																																																																																																																																																																																																																																																																																																																																																																																																																																																																																																																																									
3		ISSUED FOR PERMITS																																																																																																																																																																																																																																																																																																																																																																																																																																																																																																																																																																																																																																																																																																																																																																																																																									
NO.	DATE	DESCRIPTION																																																																																																																																																																																																																																																																																																																																																																																																																																																																																																																																																																																																																																																																																																																																																																																																																									
1		ISSUED FOR PERMITS																																																																																																																																																																																																																																																																																																																																																																																																																																																																																																																																																																																																																																																																																																																																																																																																																									
2		ISSUED FOR PERMITS																																																																																																																																																																																																																																																																																																																																																																																																																																																																																																																																																																																																																																																																																																																																																																																																																									
3		ISSUED FOR PERMITS																																																																																																																																																																																																																																																																																																																																																																																																																																																																																																																																																																																																																																																																																																																																																																																																																									
NO.	DATE	DESCRIPTION																																																																																																																																																																																																																																																																																																																																																																																																																																																																																																																																																																																																																																																																																																																																																																																																																									
1		ISSUED FOR PERMITS																																																																																																																																																																																																																																																																																																																																																																																																																																																																																																																																																																																																																																																																																																																																																																																																																									
2		ISSUED FOR PERMITS																																																																																																																																																																																																																																																																																																																																																																																																																																																																																																																																																																																																																																																																																																																																																																																																																									
3		ISSUED FOR PERMITS																																																																																																																																																																																																																																																																																																																																																																																																																																																																																																																																																																																																																																																																																																																																																																																																																									
NO.	DATE	DESCRIPTION																																																																																																																																																																																																																																																																																																																																																																																																																																																																																																																																																																																																																																																																																																																																																																																																																									
1		ISSUED FOR PERMITS																																																																																																																																																																																																																																																																																																																																																																																																																																																																																																																																																																																																																																																																																																																																																																																																																									
2		ISSUED FOR PERMITS																																																																																																																																																																																																																																																																																																																																																																																																																																																																																																																																																																																																																																																																																																																																																																																																																									
3		ISSUED FOR PERMITS																																																																																																																																																																																																																																																																																																																																																																																																																																																																																																																																																																																																																																																																																																																																																																																																																									
NO.	DATE	DESCRIPTION																																																																																																																																																																																																																																																																																																																																																																																																																																																																																																																																																																																																																																																																																																																																																																																																																									
1		ISSUED FOR PERMITS																																																																																																																																																																																																																																																																																																																																																																																																																																																																																																																																																																																																																																																																																																																																																																																																																									
2		ISSUED FOR PERMITS																																																																																																																																																																																																																																																																																																																																																																																																																																																																																																																																																																																																																																																																																																																																																																																																																									
3		ISSUED FOR PERMITS																																																																																																																																																																																																																																																																																																																																																																																																																																																																																																																																																																																																																																																																																																																																																																																																																									
NO.	DATE	DESCRIPTION																																																																																																																																																																																																																																																																																																																																																																																																																																																																																																																																																																																																																																																																																																																																																																																																																									
1		ISSUED FOR PERMITS																																																																																																																																																																																																																																																																																																																																																																																																																																																																																																																																																																																																																																																																																																																																																																																																																									
2		ISSUED FOR PERMITS																																																																																																																																																																																																																																																																																																																																																																																																																																																																																																																																																																																																																																																																																																																																																																																																																									
3		ISSUED FOR PERMITS																																																																																																																																																																																																																																																																																																																																																																																																																																																																																																																																																																																																																																																																																																																																																																																																																									
NO.	DATE	DESCRIPTION																																																																																																																																																																																																																																																																																																																																																																																																																																																																																																																																																																																																																																																																																																																																																																																																																									
1		ISSUED FOR PERMITS																																																																																																																																																																																																																																																																																																																																																																																																																																																																																																																																																																																																																																																																																																																																																																																																																									
2		ISSUED FOR PERMITS																																																																																																																																																																																																																																																																																																																																																																																																																																																																																																																																																																																																																																																																																																																																																																																																																									
3		ISSUED FOR PERMITS																																																																																																																																																																																																																																																																																																																																																																																																																																																																																																																																																																																																																																																																																																																																																																																																																									
NO.	DATE	DESCRIPTION																																																																																																																																																																																																																																																																																																																																																																																																																																																																																																																																																																																																																																																																																																																																																																																																																									
1		ISSUED FOR PERMITS																																																																																																																																																																																																																																																																																																																																																																																																																																																																																																																																																																																																																																																																																																																																																																																																																									
2		ISSUED FOR PERMITS																																																																																																																																																																																																																																																																																																																																																																																																																																																																																																																																																																																																																																																																																																																																																																																																																									
3		ISSUED FOR PERMITS																																																																																																																																																																																																																																																																																																																																																																																																																																																																																																																																																																																																																																																																																																																																																																																																																									
NO.	DATE	DESCRIPTION																																																																																																																																																																																																																																																																																																																																																																																																																																																																																																																																																																																																																																																																																																																																																																																																																									
1		ISSUED FOR PERMITS																																																																																																																																																																																																																																																																																																																																																																																																																																																																																																																																																																																																																																																																																																																																																																																																																									
2		ISSUED FOR PERMITS																																																																																																																																																																																																																																																																																																																																																																																																																																																																																																																																																																																																																																																																																																																																																																																																																									
3		ISSUED FOR PERMITS																																																																																																																																																																																																																																																																																																																																																																																																																																																																																																																																																																																																																																																																																																																																																																																																																									
NO.	DATE	DESCRIPTION																																																																																																																																																																																																																																																																																																																																																																																																																																																																																																																																																																																																																																																																																																																																																																																																																									
1		ISSUED FOR PERMITS																																																																																																																																																																																																																																																																																																																																																																																																																																																																																																																																																																																																																																																																																																																																																																																																																									
2		ISSUED FOR PERMITS																																																																																																																																																																																																																																																																																																																																																																																																																																																																																																																																																																																																																																																																																																																																																																																																																									
3		ISSUED FOR PERMITS																																																																																																																																																																																																																																																																																																																																																																																																																																																																																																																																																																																																																																																																																																																																																																																																																									
NO.	DATE	DESCRIPTION																																																																																																																																																																																																																																																																																																																																																																																																																																																																																																																																																																																																																																																																																																																																																																																																																									
1		ISSUED FOR PERMITS																																																																																																																																																																																																																																																																																																																																																																																																																																																																																																																																																																																																																																																																																																																																																																																																																									
2		ISSUED FOR PERMITS																																																																																																																																																																																																																																																																																																																																																																																																																																																																																																																																																																																																																																																																																																																																																																																																																									
3		ISSUED FOR PERMITS																																																																																																																																																																																																																																																																																																																																																																																																																																																																																																																																																																																																																																																																																																																																																																																																																									
NO.	DATE	DESCRIPTION																																																																																																																																																																																																																																																																																																																																																																																																																																																																																																																																																																																																																																																																																																																																																																																																																									
1		ISSUED FOR PERMITS																																																																																																																																																																																																																																																																																																																																																																																																																																																																																																																																																																																																																																																																																																																																																																																																																									
2		ISSUED FOR PERMITS																																																																																																																																																																																																																																																																																																																																																																																																																																																																																																																																																																																																																																																																																																																																																																																																																									
3		ISSUED FOR PERMITS																																																																																																																																																																																																																																																																																																																																																																																																																																																																																																																																																																																																																																																																																																																																																																																																																									
NO.	DATE	DESCRIPTION																																																																																																																																																																																																																																																																																																																																																																																																																																																																																																																																																																																																																																																																																																																																																																																																																									
1		ISSUED FOR PERMITS																																																																																																																																																																																																																																																																																																																																																																																																																																																																																																																																																																																																																																																																																																																																																																																																																									
2		ISSUED FOR PERMITS																																																																																																																																																																																																																																																																																																																																																																																																																																																																																																																																																																																																																																																																																																																																																																																																																									
3		ISSUED FOR PERMITS																																																																																																																																																																																																																																																																																																																																																																																																																																																																																																																																																																																																																																																																																																																																																																																																																									
NO.	DATE	DESCRIPTION																																																																																																																																																																																																																																																																																																																																																																																																																																																																																																																																																																																																																																																																																																																																																																																																																									
1		ISSUED FOR PERMITS																																																																																																																																																																																																																																																																																																																																																																																																																																																																																																																																																																																																																																																																																																																																																																																																																									
2		ISSUED FOR PERMITS																																																																																																																																																																																																																																																																																																																																																																																																																																																																																																																																																																																																																																																																																																																																																																																																																									
3		ISSUED FOR PERMITS																																																																																																																																																																																																																																																																																																																																																																																																																																																																																																																																																																																																																																																																																																																																																																																																																									
NO.	DATE	DESCRIPTION																																																																																																																																																																																																																																																																																																																																																																																																																																																																																																																																																																																																																																																																																																																																																																																																																									
1		ISSUED FOR PERMITS																																																																																																																																																																																																																																																																																																																																																																																																																																																																																																																																																																																																																																																																																																																																																																																																																									
2		ISSUED FOR PERMITS																																																																																																																																																																																																																																																																																																																																																																																																																																																																																																																																																																																																																																																																																																																																																																																																																									
3		ISSUED FOR PERMITS																																																																																																																																																																																																																																																																																																																																																																																																																																																																																																																																																																																																																																																																																																																																																																																																																									
NO.	DATE	DESCRIPTION																																																																																																																																																																																																																																																																																																																																																																																																																																																																																																																																																																																																																																																																																																																																																																																																																									
1		ISSUED FOR PERMITS																																																																																																																																																																																																																																																																																																																																																																																																																																																																																																																																																																																																																																																																																																																																																																																																																									
2		ISSUED FOR PERMITS																																																																																																																																																																																																																																																																																																																																																																																																																																																																																																																																																																																																																																																																																																																																																																																																																									
3		ISSUED FOR PERMITS																																																																																																																																																																																																																																																																																																																																																																																																																																																																																																																																																																																																																																																																																																																																																																																																																									
NO.	DATE	DESCRIPTION																																																																																																																																																																																																																																																																																																																																																																																																																																																																																																																																																																																																																																																																																																																																																																																																																									
1		ISSUED FOR PERMITS																																																																																																																																																																																																																																																																																																																																																																																																																																																																																																																																																																																																																																																																																																																																																																																																																									
2		ISSUED FOR PERMITS																																																																																																																																																																																																																																																																																																																																																																																																																																																																																																																																																																																																																																																																																																																																																																																																																									
3		ISSUED FOR PERMITS																																																																																																																																																																																																																																																																																																																																																																																																																																																																																																																																																																																																																																																																																																																																																																																																																									
NO.	DATE	DESCRIPTION																																																																																																																																																																																																																																																																																																																																																																																																																																																																																																																																																																																																																																																																																																																																																																																																																									
1		ISSUED FOR PERMITS																																																																																																																																																																																																																																																																																																																																																																																																																																																																																																																																																																																																																																																																																																																																																																																																																									
2		ISSUED FOR PERMITS																																																																																																																																																																																																																																																																																																																																																																																																																																																																																																																																																																																																																																																																																																																																																																																																																									
3		ISSUED FOR PERMITS																																																																																																																																																																																																																																																																																																																																																																																																																																																																																																																																																																																																																																																																																																																																																																																																																									
NO.	DATE	DESCRIPTION																																																																																																																																																																																																																																																																																																																																																																																																																																																																																																																																																																																																																																																																																																																																																																																																																									
1		ISSUED FOR PERMITS																																																																																																																																																																																																																																																																																																																																																																																																																																																																																																																																																																																																																																																																																																																																																																																																																									
2		ISSUED FOR PERMITS																																																																																																																																																																																																																																																																																																																																																																																																																																																																																																																																																																																																																																																																																																																																																																																																																									
3		ISSUED FOR PERMITS																																																																																																																																																																																																																																																																																																																																																																																																																																																																																																																																																																																																																																																																																																																																																																																																																									
NO.	DATE	DESCRIPTION																																																																																																																																																																																																																																																																																																																																																																																																																																																																																																																																																																																																																																																																																																																																																																																																																									
1		ISSUED FOR PERMITS																																																																																																																																																																																																																																																																																																																																																																																																																																																																																																																																																																																																																																																																																																																																																																																																																									
2		ISSUED FOR PERMITS																																																																																																																																																																																																																																																																																																																																																																																																																																																																																																																																																																																																																																																																																																																																																																																																																									
3		ISSUED FOR PERMITS																																																																																																																																																																																																																																																																																																																																																																																																																																																																																																																																																																																																																																																																																																																																																																																																																									
NO.	DATE	DESCRIPTION																																																																																																																																																																																																																																																																																																																																																																																																																																																																																																																																																																																																																																																																																																																																																																																																																									
1		ISSUED FOR PERMITS																																																																																																																																																																																																																																																																																																																																																																																																																																																																																																																																																																																																																																																																																																																																																																																																																									
2		ISSUED FOR PERMITS																																																																																																																																																																																																																																																																																																																																																																																																																																																																																																																																																																																																																																																																																																																																																																																																																									
3		ISSUED FOR PERMITS																																																																																																																																																																																																																																																																																																																																																																																																																																																																																																																																																																																																																																																																																																																																																																																																																									
NO.	DATE	DESCRIPTION																																																																																																																																																																																																																																																																																																																																																																																																																																																																																																																																																																																																																																																																																																																																																																																																																									
1		ISSUED FOR PERMITS																																																																																																																																																																																																																																																																																																																																																																																																																																																																																																																																																																																																																																																																																																																																																																																																																									
2		ISSUED FOR PERMITS																																																																																																																																																																																																																																																																																																																																																																																																																																																																																																																																																																																																																																																																																																																																																																																																																									
3		ISSUED FOR PERMITS																																																																																																																																																																																																																																																																																																																																																																																																																																																																																																																																																																																																																																																																																																																																																																																																																									
NO.	DATE	DESCRIPTION																																																																																																																																																																																																																																																																																																																																																																																																																																																																																																																																																																																																																																																																																																																																																																																																																									
1		ISSUED FOR PERMITS																																																																																																																																																																																																																																																																																																																																																																																																																																																																																																																																																																																																																																																																																																																																																																																																																									
2		ISSUED FOR PERMITS																																																																																																																																																																																																																																																																																																																																																																																																																																																																																																																																																																																																																																																																																																																																																																																																																									
3		ISSUED FOR PERMITS																																																																																																																																																																																																																																																																																																																																																																																																																																																																																																																																																																																																																																																																																																																																																																																																																									
NO.	DATE	DESCRIPTION																																																																																																																																																																																																																																																																																																																																																																																																																																																																																																																																																																																																																																																																																																																																																																																																																									
1		ISSUED FOR PERMITS																																																																																																																																																																																																																																																																																																																																																																																																																																																																																																																																																																																																																																																																																																																																																																																																																									
2		ISSUED FOR PERMITS																																																																																																																																																																																																																																																																																																																																																																																																																																																																																																																																																																																																																																																																																																																																																																																																																									
3		ISSUED FOR PERMITS																																																																																																																																																																																																																																																																																																																																																																																																																																																																																																																																																																																																																																																																																																																																																																																																																									
NO.	DATE	DESCRIPTION																																																																																																																																																																																																																																																																																																																																																																																																																																																																																																																																																																																																																																																																																																																																																																																																																									
1		ISSUED FOR PERMITS																																																																																																																																																																																																																																																																																																																																																																																																																																																																																																																																																																																																																																																																																																																																																																																																																									
2		ISSUED FOR PERMITS																																																																																																																																																																																																																																																																																																																																																																																																																																																																																																																																																																																																																																																																																																																																																																																																																									
3		ISSUED FOR PERMITS																																																																																																																																																																																																																																																																																																																																																																																																																																																																																																																																																																																																																																																																																																																																																																																																																									
NO.	DATE	DESCRIPTION																																																																																																																																																																																																																																																																																																																																																																																																																																																																																																																																																																																																																																																																																																																																																																																																																									
1		ISSUED FOR PERMITS																																																																																																																																																																																																																																																																																																																																																																																																																																																																																																																																																																																																																																																																																																																																																																																																																									
2		ISSUED FOR PERMITS																																																																																																																																																																																																																																																																																																																																																																																																																																																																																																																																																																																																																																																																																																																																																																																																																									
3		ISSUED FOR PERMITS																																																																																																																																																																																																																																																																																																																																																																																																																																																																																																																																																																																																																																																																																																																																																																																																																									
NO.	DATE	DESCRIPTION																																																																																																																																																																																																																																																																																																																																																																																																																																																																																																																																																																																																																																																																																																																																																																																																																									
1		ISSUED FOR PERMITS																																																																																																																																																																																																																																																																																																																																																																																																																																																																																																																																																																																																																																																																																																																																																																																																																									
2		ISSUED FOR PERMITS																																																																																																																																																																																																																																																																																																																																																																																																																																																																																																																																																																																																																																																																																																																																																																																																																									
3		ISSUED FOR PERMITS																																																																																																																																																																																																																																																																																																																																																																																																																																																																																																																																																																																																																																																																																																																																																																																																																									
NO.	DATE	DESCRIPTION																																																																																																																																																																																																																																																																																																																																																																																																																																																																																																																																																																																																																																																																																																																																																																																																																									
1		ISSUED FOR PERMITS																																																																																																																																																																																																																																																																																																																																																																																																																																																																																																																																																																																																																																																																																																																																																																																																																									
2		ISSUED FOR PERMITS																																																																																																																																																																																																																																																																																																																																																																																																																																																																																																																																																																																																																																																																																																																																																																																																																									
3		ISSUED FOR PERMITS																																																																																																																																																																																																																																																																																																																																																																																																																																																																																																																																																																																																																																																																																																																																																																																																																									
NO.	DATE	DESCRIPTION																																																																																																																																																																																																																																																																																																																																																																																																																																																																																																																																																																																																																																																																																																																																																																																																																									
1		ISSUED FOR PERMITS																																																																																																																																																																																																																																																																																																																																																																																																																																																																																																																																																																																																																																																																																																																																																																																																																									
2		ISSUED FOR PERMITS																																																																																																																																																																																																																																																																																																																																																																																																																																																																																																																																																																																																																																																																																																																																																																																																																									
3		ISSUED FOR PERMITS																																																																																																																																																																																																																																																																																																																																																																																																																																																																																																																																																																																																																																																																																																																																																																																																																									
NO.	DATE	DESCRIPTION																																																																																																																																																																																																																																																																																																																																																																																																																																																																																																																																																																																																																																																																																																																																																																																																																									
1		ISSUED FOR PERMITS																																																																																																																																																																																																																																																																																																																																																																																																																																																																																																																																																																																																																																																																																																																																																																																																																									
2		ISSUED FOR PERMITS																																																																																																																																																																																																																																																																																																																																																																																																																																																																																																																																																																																																																																																																																																																																																																																																																									
3		ISSUED FOR PERMITS																																																																																																																																																																																																																																																																																																																																																																																																																																																																																																																																																																																																																																																																																																																																																																																																																									
NO.	DATE	DESCRIPTION																																																																																																																																																																																																																																																																																																																																																																																																																																																																																																																																																																																																																																																																																																																																																																																																																									
1		ISSUED FOR PERMITS																																																																																																																																																																																																																																																																																																																																																																																																																																																																																																																																																																																																																																																																																																																																																																																																																									
2		ISSUED FOR PERMITS																																																																																																																																																																																																																																																																																																																																																																																																																																																																																																																																																																																																																																																																																																																																																																																																																									
3		ISSUED FOR PERMITS																																																																																																																																																																																																																																																																																																																																																																																																																																																																																																																																																																																																																																																																																																																																																																																																																									
NO.	DATE	DESCRIPTION																																																																																																																																																																																																																																																																																																																																																																																																																																																																																																																																																																																																																																																																																																																																																																																																																									
1		ISSUED FOR PERMITS																																																																																																																																																																																																																																																																																																																																																																																																																																																																																																																																																																																																																																																																																																																																																																																																																									
2		ISSUED FOR PERMITS																																																																																																																																																																																																																																																																																																																																																																																																																																																																																																																																																																																																																																																																																																																																																																																																																									
3		ISSUED FOR PERMITS																																																																																																																																																																																																																																																																																																																																																																																																																																																																																																																																																																																																																																																																																																																																																																																																																									
NO.	DATE	DESCRIPTION																																																																																																																																																																																																																																																																																																																																																																																																																																																																																																																																																																																																																																																																																																																																																																																																																									
1		ISSUED FOR PERMITS																																																																																																																																																																																																																																																																																																																																																																																																																																																																																																																																																																																																																																																																																																																																																																																																																									
2		ISSUED FOR PERMITS																																																																																																																																																																																																																																																																																																																																																																																																																																																																																																																																																																																																																																																																																																																																																																																																																									
3		ISSUED FOR PERMITS																																																																																																																																																																																																																																																																																																																																																																																																																																																																																																																																																																																																																																																																																																																																																																																																																									
NO.	DATE	DESCRIPTION																																																																																																																																																																																																																																																																																																																																																																																																																																																																																																																																																																																																																																																																																																																																																																																																																									
1		ISSUED FOR PERMITS																																																																																																																																																																																																																																																																																																																																																																																																																																																																																																																																																																																																																																																																																																																																																																																																																									
2		ISSUED FOR PERMITS																																																																																																																																																																																																																																																																																																																																																																																																																																																																																																																																																																																																																																																																																																																																																																																																																									
3		ISSUED FOR PERMITS																																																																																																																																																																																																																																																																																																																																																																																																																																																																																																																																																																																																																																																																																																																																																																																																																									
NO.	DATE	DESCRIPTION																																																																																																																																																																																																																																																																																																																																																																																																																																																																																																																																																																																																																																																																																																																																																																																																																									
1		ISSUED FOR PERMITS																																																																																																																																																																																																																																																																																																																																																																																																																																																																																																																																																																																																																																																																																																																																																																																																																									
2		ISSUED FOR PERMITS																																																																																																																																																																																																																																																																																																																																																																																																																																																																																																																																																																																																																																																																																																																																																																																																																									
3		ISSUED FOR PERMITS																																																																																																																																																																																																																																																																																																																																																																																																																																																																																																																																																																																																																																																																																																																																																																																																																									
NO.	DATE	DESCRIPTION																																																																																																																																																																																																																																																																																																																																																																																																																																																																																																																																																																																																																																																																																																																																																																																																																									
1		ISSUED FOR PERMITS																																																																																																																																																																																																																																																																																																																																																																																																																																																																																																																																																																																																																																																																																																																																																																																																																									
2		ISSUED FOR PERMITS																																																																																																																																																																																																																																																																																																																																																																																																																																																																																																																																																																																																																																																																																																																																																																																																																									
3		ISSUED FOR PERMITS																																																																																																																																																																																																																																																																																																																																																																																																																																																																																																																																																																																																																																																																																																																																																																																																																									
NO.	DATE	DESCRIPTION																																																																																																																																																																																																																																																																																																																																																																																																																																																																																																																																																																																																																																																																																																																																																																																																																									
1		ISSUED FOR PERMITS																																																																																																																																																																																																																																																																																																																																																																																																																																																																																																																																																																																																																																																																																																																																																																																																																									
2		ISSUED FOR PERMITS																																																																																																																																																																																																																																																																																																																																																																																																																																																																																																																																																																																																																																																																																																																																																																																																																									
3		ISSUED FOR PERMITS																																																																																																																																																																																																																																																																																																																																																																																																																																																																																																																																																																																																																																																																																																																																																																																																																									
NO.	DATE	DESCRIPTION																																																																																																																																																																																																																																																																																																																																																																																																																																																																																																																																																																																																																																																																																																																																																																																																																									
1		ISSUED FOR PERMITS																																																																																																																																																																																																																																																																																																																																																																																																																																																																																																																																																																																																																																																																																																																																																																																																																									
2		ISSUED FOR PERMITS																																																																																																																																																																																																																																																																																																																																																																																																																																																																																																																																																																																																																																																																																																																																																																																																																									
3		ISSUED FOR PERMITS																																																																																																																																																																																																																																																																																																																																																																																																																																																																																																																																																																																																																																																																																																																																																																																																																									
NO.	DATE	DESCRIPTION																																																																																																																																																																																																																																																																																																																																																																																																																																																																																																																																																																																																																																																																																																																																																																																																																									
1		ISSUED FOR PERMITS																																																																																																																																																																																																																																																																																																																																																																																																																																																																																																																																																																																																																																																																																																																																																																																																																									
2		ISSUED FOR PERMITS																																																																																																																																																																																																																																																																																																																																																																																																																																																																																																																																																																																																																																																																																																																																																																																																																									
3		ISSUED FOR PERMITS																																																																																																																																																																																																																																																																																																																																																																																																																																																																																																																																																																																																																																																																																																																																																																																																																									
NO.	DATE	DESCRIPTION																																																																																																																																																																																																																																																																																																																																																																																																																																																																																																																																																																																																																																																																																																																																																																																																																									
1		ISSUED FOR PERMITS																																																																																																																																																																																																																																																																																																																																																																																																																																																																																																																																																																																																																																																																																																																																																																																																																									
2		ISSUED FOR PERMITS																																																																																																																																																																																																																																																																																																																																																																																																																																																																																																																																																																																																																																																																																																																																																																																																																									
3		ISSUED FOR PERMITS																																																																																																																																																																																																																																																																																																																																																																																																																																																																																																																																																																																																																																																																																																																																																																																																																									
NO.	DATE	DESCRIPTION																																																																																																																																																																																																																																																																																																																																																																																																																																																																																																																																																																																																																																																																																																																																																																																																																									
1		ISSUED FOR PERMITS																																																																																																																																																																																																																																																																																																																																																																																																																																																																																																																																																																																																																																																																																																																																																																																																																									
2		ISSUED FOR PERMITS																																																																																																																																																																																																																																																																																																																																																																																																																																																																																																																																																																																																																																																																																																																																																																																																																									
3		ISSUED FOR PERMITS																																																																																																																																																																																																																																																																																																																																																																																																																																																																																																																																																																																																																																																																																																																																																																																																																									
NO.	DATE	DESCRIPTION																																																																																																																																																																																																																																																																																																																																																																																																																																																																																																																																																																																																																																																																																																																																																																																																																									
1		ISSUED FOR PERMITS																																																																																																																																																																																																																																																																																																																																																																																																																																																																																																																																																																																																																																																																																																																																																																																																																									
2		ISSUED FOR PERMITS																																																																																																																																																																																																																																																																																																																																																																																																																																																																																																																																																																																																																																																																																																																																																																																																																									
3		ISSUED FOR PERMITS																																																																																																																																																																																																																																																																																																																																																																																																																																																																																																																																																																																																																																																																																																																																																																																																																									
NO.	DATE	DESCRIPTION																																																																																																																																																																																																																																																																																																																																																																																																																																																																																																																																																																																																																																																																																																																																																																																																																									
1		ISSUED FOR PERMITS																																																																																																																																																																																																																																																																																																																																																																																																																																																																																																																																																																																																																																																																																																																																																																																																																									
2		ISSUED FOR PERMITS																																																																																																																																																																																																																																																																																																																																																																																																																																																																																																																																																																																																																																																																																																																																																																																																																									
3		ISSUED FOR PERMITS																																																																																																																																																																																																																																																																																																																																																																																																																																																																																																																																																																																																																																																																																																																																																																																																																									
NO.	DATE	DESCRIPTION																																																																																																																																																																																																																																																																																																																																																																																																																																																																																																																																																																																																																																																																																																																																																																																																																									
1		ISSUED FOR PERMITS																																																																																																																																																																																																																																																																																																																																																																																																																																																																																																																																																																																																																																																																																																																																																																																																																									
2		ISSUED FOR PERMITS																																																																																																																																																																																																																																																																																																																																																																																																																																																																																																																																																																																																																																																																																																																																																																																																																									
3		ISSUED FOR PERMITS																																																																																																																																																																																																																																																																																																																																																																																																																																																																																																																																																																																																																																																																																																																																																																																																																									
NO.	DATE	DESCRIPTION																																																																																																																																																																																																																																																																																																																																																																																																																																																																																																																																																																																																																																																																																																																																																																																																																									
1		ISSUED FOR PERMITS																																																																																																																																																																																																																																																																																																																																																																																																																																																																																																																																																																																																																																																																																																																																																																																																																									
2		ISSUED FOR PERMITS																																																																																																																																																																																																																																																																																																																																																																																																																																																																																																																																																																																																																																																																																																																																																																																																																									
3		ISSUED FOR PERMITS																																																																																																																																																																																																																																																																																																																																																																																																																																																																																																																																																																																																																																																																																																																																																																																																																									
NO.	DATE	DESCRIPTION																																																																																																																																																																																																																																																																																																																																																																																																																																																																																																																																																																																																																																																																																																																																																																																																																									
1		ISSUED FOR PERMITS																																																																																																																																																																																																																																																																																																																																																																																																																																																																																																																																																																																																																																																																																																																																																																																																																									
2		ISSUED FOR PERMITS																																																																																																																																																																																																																																																																																																																																																																																																																																																																																																																																																																																																																																																																																																																																																																																																																									
3		ISSUED FOR PERMITS																																																																																																																																																																																																																																																																																																																																																																																																																																																																																																																																																																																																																																																																																																																																																																																																																									
NO.	DATE	DESCRIPTION																																																																																																																																																																																																																																																																																																																																																																																																																																																																																																																																																																																																																																																																																																																																																																																																																									
1		ISSUED FOR PERMITS																																																																																																																																																																																																																																																																																																																																																																																																																																																																																																																																																																																																																																																																																																																																																																																																																									
2		ISSUED FOR PERMITS																																																																																																																																																																																																																																																																																																																																																																																																																																																																																																																																																																																																																																																																																																																																																																																																																									
3		ISSUED FOR PERMITS																																																																																																																																																																																																																																																																																																																																																																																																																																																																																																																																																																																																																																																																																																																																																																																																																									
NO.	DATE	DESCRIPTION																																																																																																																																																																																																																																																																																																																																																																																																																																																																																																																																																																																																																																																																																																																																																																																																																									
1		ISSUED FOR PERMITS																																																																																																																																																																																																																																																																																																																																																																																																																																																																																																																																																																																																																																																																																																																																																																																																																									
2		ISSUED FOR PERMITS																																																																																																																																																																																																																																																																																																																																																																																																																																																																																																																																																																																																																																																																																																																																																																																																																									
3		ISSUED FOR PERMITS																																																																																																																																																																																																																																																																																																																																																																																																																																																																																																																																																																																																																																																																																																																																																																																																																									
NO.	DATE	DESCRIPTION																																																																																																																																																																																																																																																																																																																																																																																																																																																																																																																																																																																																																																																																																																																																																																																																																									
1		ISSUED FOR PERMITS																																																																																																																																																																																																																																																																																																																																																																																																																																																																																																																																																																																																																																																																																																																																																																																																																									
2		ISSUED FOR PERMITS																																																																																																																																																																																																																																																																																																																																																																																																																																																																																																																																																																																																																																																																																																																																																																																																																									
3		ISSUED FOR PERMITS																																																																																																																																																																																																																																																																																																																																																																																																																																																																																																																																																																																																																																																																																																																																																																																																																									
NO.	DATE	DESCRIPTION																																																																																																																																																																																																																																																																																																																																																																																																																																																																																																																																																																																																																																																																																																																																																																																																																									
1		ISSUED FOR PERMITS																																																																																																																																																																																																																																																																																																																																																																																																																																																																																																																																																																																																																																																																																																																																																																																																																									
2		ISSUED FOR PERMITS																																																																																																																																																																																																																																																																																																																																																																																																																																																																																																																																																																																																																																																																																																																																																																																																																									
3		ISSUED FOR PERMITS																																																																																																																																																																																																																																																																																																																																																																																																																																																																																																																																																																																																																																																																																																																																																																																																																									
NO.	DATE	DESCRIPTION																																																																																																																																																																																																																																																																																																																																																																																																																																																																																																																																																																																																																																																																																																																																																																																																																									
1		ISSUED FOR PERMITS																																																																																																																																																																																																																																																																																																																																																																																																																																																																																																																																																																																																																																																																																																																																																																																																																									
2		ISSUED FOR PERMITS																																																																																																																																																																																																																																																																																																																																																																																																																																																																																																																																																																																																																																																																																																																																																																																																																									
3		ISSUED FOR PERMITS																																																																																																																																																																																																																																																																																																																																																																																																																																																																																																																																																																																																																																																																																																																																																																																																																									
NO.	DATE	DESCRIPTION																																																																																																																																																																																																																																																																																																																																																																																																																																																																																																																																																																																																																																																																																																																																																																																																																									
1		ISSUED FOR PERMITS																																																																																																																																																																																																																																																																																																																																																																																																																																																																																																																																																																																																																																																																																																																																																																																																																									
2		ISSUED FOR PERMITS																																																																																																																																																																																																																																																																																																																																																																																																																																																																																																																																																																																																																																																																																																																																																																																																																									
3		ISSUED FOR PERMITS																																																																																																																																																																																																																																																																																																																																																																																																																																																																																																																																																																																																																																																																																																																																																																																																																									
NO.	DATE	DESCRIPTION																																																																																																																																																																																																																																																																																																																																																																																																																																																																																																																																																																																																																																																																																																																																																																																																																									
1		ISSUED FOR PERMITS																																																																																																																																																																																																																																																																																																																																																																																																																																																																																																																																																																																																																																																																																																																																																																																																																									
2		ISSUED FOR PERMITS																																																																																																																																																																																																																																																																																																																																																																																																																																																																																																																																																																																																																																																																																																																																																																																																																									
3		ISSUED FOR PERMITS																																																																																																																																																																																																																																																																																																																																																																																																																																																																																																																																																																																																																																																																																																																																																																																																																									
NO.	DATE	DESCRIPTION																																																																																																																																																																																																																																																																																																																																																																																																																																																																																																																																																																																																																																																																																																																																																																																																																									
1		ISSUED FOR PERMITS																																																																																																																																																																																																																																																																																																																																																																																																																																																																																																																																																																																																																																																																																																																																																																																																																									
2		ISSUED FOR PERMITS																																																																																																																																																																																																																																																																																																																																																																																																																																																																																																																																																																																																																																																																																																																																																																																																																									
3		ISSUED FOR PERMITS																																																																																																																																																																																																																																																																																																																																																																																																																																																																																																																																																																																																																																																																																																																																																																																																																									
NO.	DATE	DESCRIPTION																																																																																																																																																																																																																																																																																																																																																																																																																																																																																																																																																																																																																																																																																																																																																																																																																									
1		ISSUED FOR PERMITS																																																																																																																																																																																																																																																																																																																																																																																																																																																																																																																																																																																																																																																																																																																																																																																																																									
2		ISSUED FOR PERMITS																																																																																																																																																																																																																																																																																																																																																																																																																																																																																																																																																																																																																																																																																																																																																																																																																									
3		ISSUED FOR PERMITS																																																																																																																																																																																																																																																																																																																																																																																																																																																																																																																																																																																																																																																																																																																																																																																																																									
NO.	DATE	DESCRIPTION																																																																																																																																																																																																																																																																																																																																																																																																																																																																																																																																																																																																																																																																																																																																																																																																																									
1		ISSUED FOR PERMITS																																																																																																																																																																																																																																																																																																																																																																																																																																																																																																																																																																																																																																																																																																																																																																																																																									
2		ISSUED FOR PERMITS																																																																																																																																																																																																																																																																																																																																																																																																																																																																																																																																																																																																																																																																																																																																																																																																																									
3		ISSUED FOR PERMITS																																																																																																																																																																																																																																																																																																																																																																																																																																																																																																																																																																																																																																																																																																																																																																																																																									
NO.	DATE	DESCRIPTION																																																																																																																																																																																																																																																																																																																																																																																																																																																																																																																																																																																																																																																																																																																																																																																																																									
1		ISSUED FOR PERMITS																																																																																																																																																																																																																																																																																																																																																																																																																																																																																																																																																																																																																																																																																																																																																																																																																									
2		ISSUED FOR PERMITS																																																																																																																																																																																																																																																																																																																																																																																																																																																																																																																																																																																																																																																																																																																																																																																																																									
3		ISSUED FOR PERMITS																																																																																																																																																																																																																																																																																																																																																																																																																																																																																																																																																																																																																																																																																																																																																																																																																									
NO.	DATE	DESCRIPTION																																																																																																																																																																																																																																																																																																																																																																																																																																																																																																																																																																																																																																																																																																																																																																																																																									
1		ISSUED FOR PERMITS																																																																																																																																																																																																																																																																																																																																																																																																																																																																																																																																																																																																																																																																																																																																																																																																																									
2		ISSUED FOR PERMITS																																																																																																																																																																																																																																																																																																																																																																																																																																																																																																																																																																																																																																																																																																																																																																																																																									
3		ISSUED FOR PERMITS																																																																																																																																																																																																																																																																																																																																																																																																																																																																																																																																																																																																																																																																																																																																																																																																																									
NO.	DATE	DESCRIPTION																																																																																																																																																																																																																																																																																																																																																																																																																																																																																																																																																																																																																																																																																																																																																																																																																									
1		ISSUED FOR PERMITS																																																																																																																																																																																																																																																																																																																																																																																																																																																																																																																																																																																																																																																																																																																																																																																																																									
2		ISSUED FOR PERMITS																																																																																																																																																																																																																																																																																																																																																																																																																																																																																																																																																																																																																																																																																																																																																																																																																									
3		ISSUED FOR PERMITS																																																																																																																																																																																																																																																																																																																																																																																																																																																																																																																																																																																																																																																																																																																																																																																																																									



美特鋁質有限公司  
MIDI ALUMINIUM FABRICATOR LTD.

PROJECT: 康城11期凱柏

項目: 鋁窗, 鋁門及幕牆玻璃

TOWER: 2A

樓層:

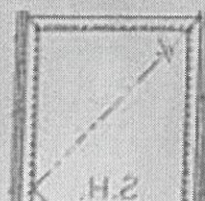
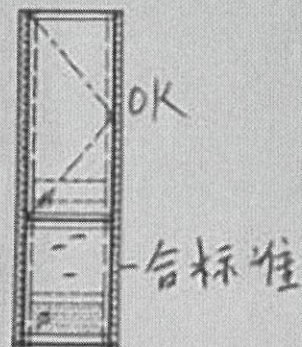
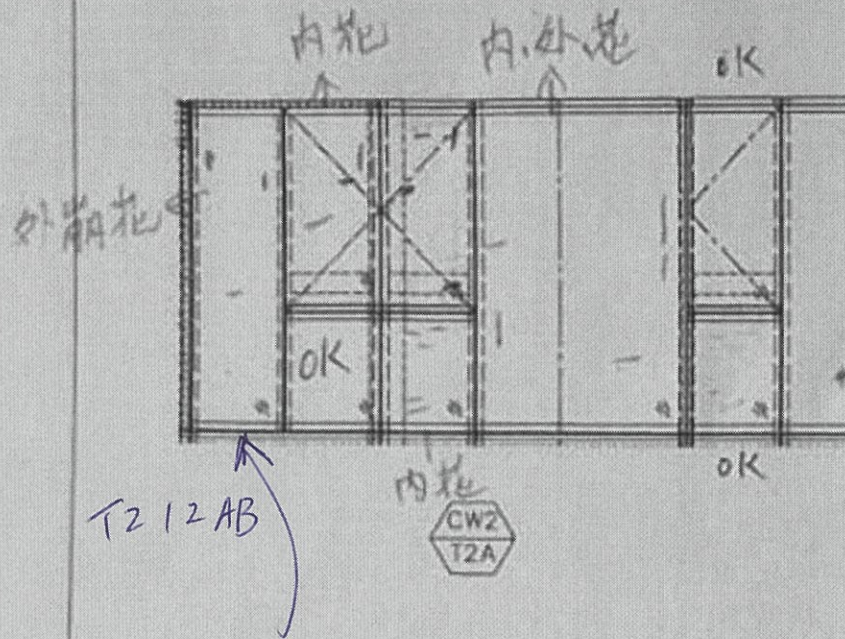



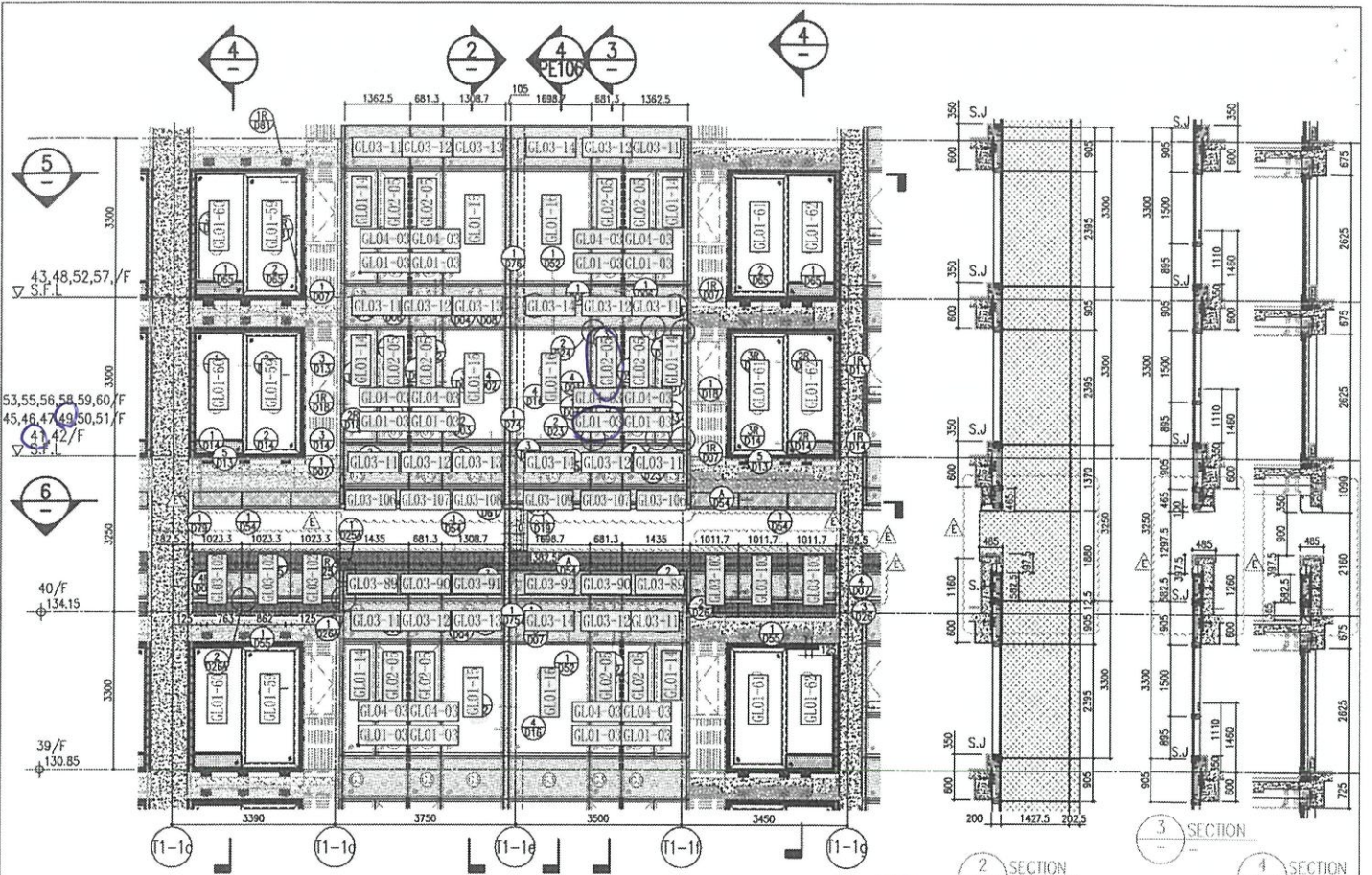

1 PART ELEVATION FOR CURTAIN WALL  
 49BA  
 GLO1-03  
 41 BA  
 GLO2-05

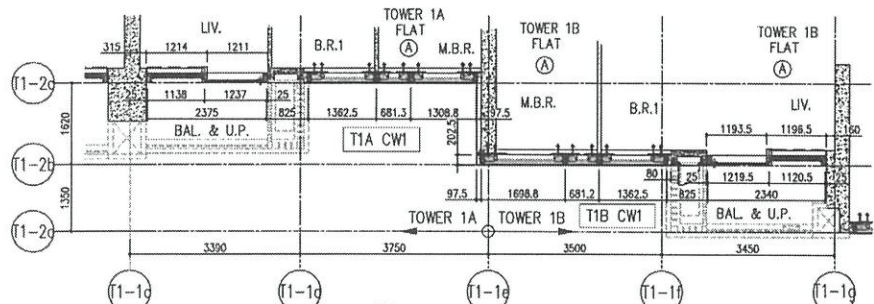

5 PART PLAN FOR CURTAIN WALL

26/F +91.25	39/F +130.85	52/F +170.40	
25/F +87.95	38/F +127.55	51/F +167.10	
23/F +84.65	37/F +124.25	50/F +163.80	R/F +203.80
22/F +81.35	36/F +120.95	49/F +160.50	62/F +200.30
21/F +78.05	35/F +117.65	48/F +157.20	61/F +196.80
20/F +74.75	33/F +114.35	47/F +153.90	60/F +193.50
19/F +71.45	32/F +111.05	46/F +150.60	59/F +190.20
18/F +68.15	31/F 107.75	45/F +147.30	58/F +186.90
17/F +64.85	30/F +104.45	43/F +144.00	57/F +183.60
16/F +61.55	29/F +101.15	42/F +140.70	56/F +180.30
15/F +58.25	28/F +97.85	41/F +137.40	55/F +177.00
12/F +54.95	27/F +94.55	40/F +134.15	53/F +173.70

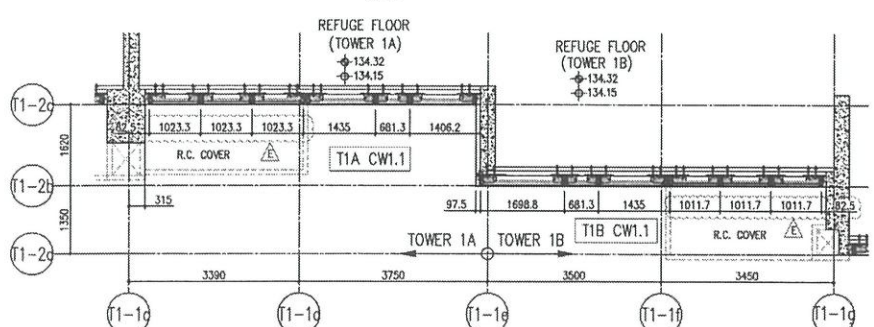

6 PART PLAN (40/F) FOR CURTAIN WALL

LEGEND:

- 10mm THK HEAT STRENGTHENED GLASS (OUTSIDE) + 12mm AIR SPACE + 12mm THK TEMPERED GLASS
- 10mm THK HEAT STRENGTHENED GLASS (OUTSIDE) + 12mm AIR SPACE + 10mm THK TEMPERED GLASS
- 12mm THK HEAT STRENGTHENED GLASS
- 12mm THK CLEAR TEMPERED GLASS (INTERNAL PROTECTIVE BARRIER)
- 12mm CLEAR HEAT STRENGTHENED GLASS
- 10mm CLEAR TEMPERED GLASS
- 8mm THK CLEAR HEAT-STRENGTHENED GLASS + 1.52mm PVB + 8mm THK CLEAR HEAT-STRENGTHENED GLASS
- 3mm THK ALUM. CLADDING
- 3mm THK ALUM BACKPAN
- STACK JOINT

DATE: 22-07-21 SCALE: 1:50(A4)

PROJECT: TYPICAL FLOOR PARTIAL ELEVATION & SECTION, PLAN FOR CURTAIN WALL (TOWER 1)

DESIGNER: MIDJI ARCHITECTURE PRACTICE LTD.

CLIENT: 怡和置業有限公司 Sino Land Company Limited

STRUCTURAL ENGINEER: Gammon

FRAME CONSULTANT: AECOM

REVISIONS:

NO.	DATE	REVISION
1	13/06/21	ISSUED FOR PER COMMENTS
2	14/06/21	REVISED AS PER COMMENTS
3	15/07/21	REVISED AS PER COMMENTS
4	18/07/21	REVISED AS PER COMMENTS
5	19/07/21	REVISED AS PER COMMENTS
6	20/07/21	REVISED AS PER COMMENTS
7	21/07/21	REVISED AS PER COMMENTS
8	22/07/21	REVISED AS PER COMMENTS

LEGEND:

- DETAIL WORK NO.
- REFER SHEET NO.
- FINISHED FLOOR LEVEL
- STRUCTURAL FLOOR LEVEL
- REVERSED DETAIL

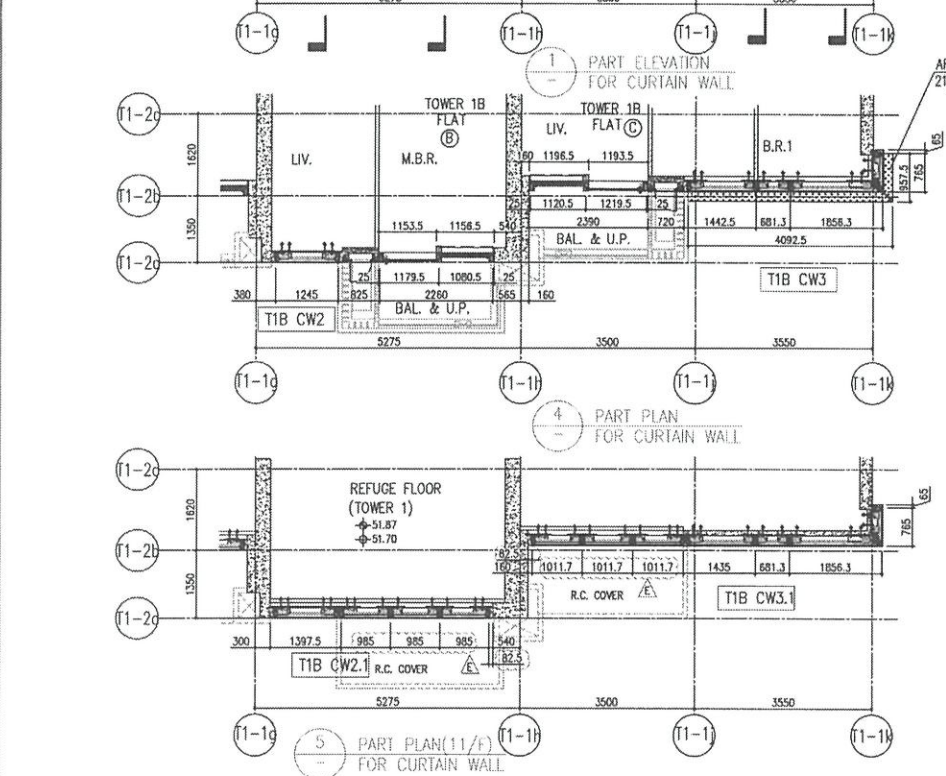
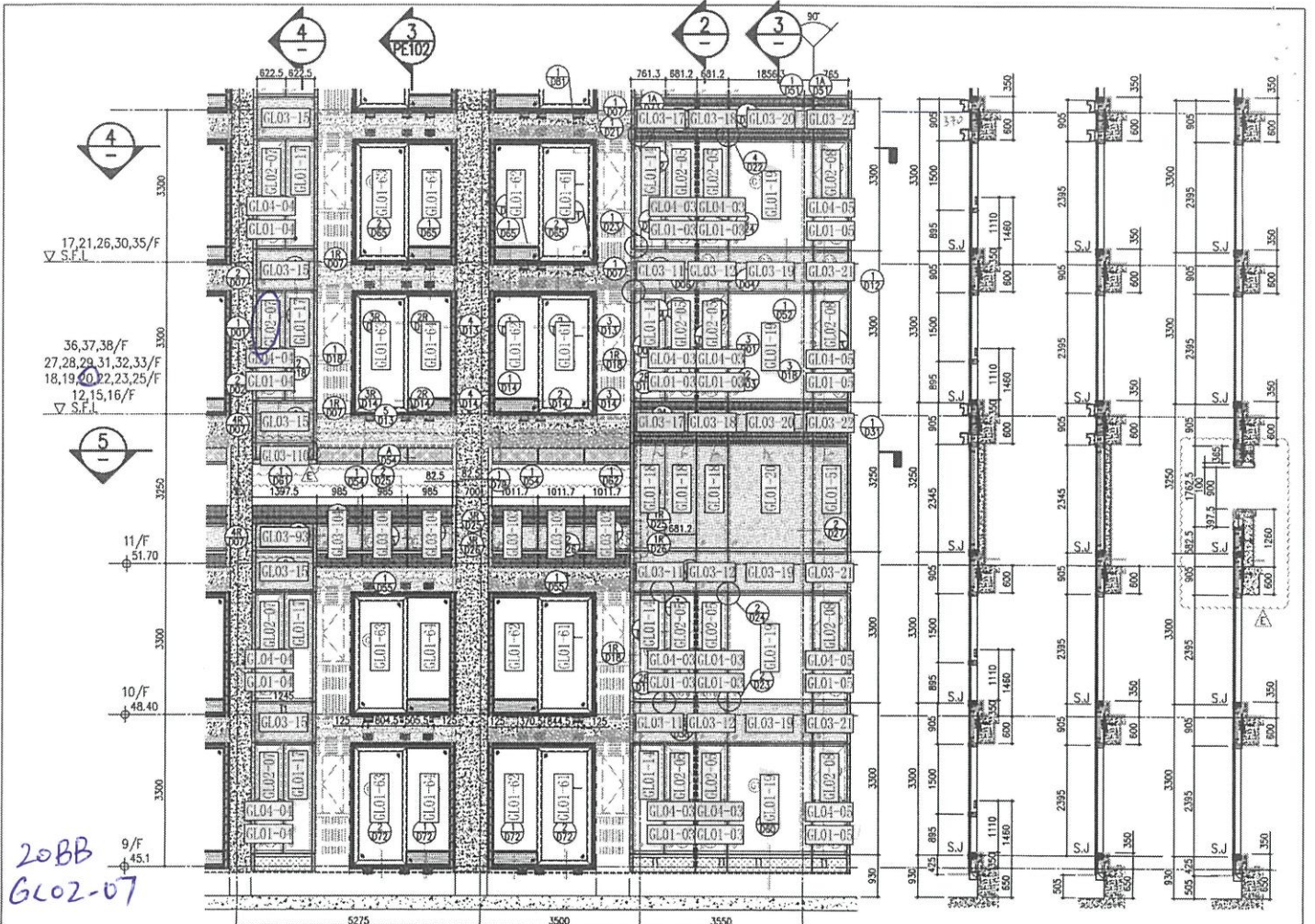

ARCH. FEATURE AT 11/F, 17/F, 21/F, 26/F, 30/F, 35/F

26/F +91.25	39/F +130.85	52/F +170.40	
25/F +87.95	38/F +127.55	51/F +167.10	
23/F +84.65	37/F +124.25	50/F +163.80	R/F +203.80
22/F +81.35	36/F +120.95	49/F +160.50	62/F +200.30
21/F +78.05	35/F +117.65	48/F +157.20	61/F +196.80
20/F +74.75	33/F +114.35	47/F +153.90	60/F +193.50
19/F +71.45	32/F +111.05	46/F +150.60	59/F +190.20
18/F +68.15	31/F 107.75	45/F +147.30	58/F +186.90
17/F +64.85	30/F +104.45	43/F +144.00	57/F +183.60
16/F +61.55	29/F +101.15	42/F +140.70	56/F +180.30
15/F +58.25	28/F +97.85	41/F +137.40	55/F +177.00
12/F +54.95	27/F +94.55	40/F +134.15	53/F +173.70

- LEGEND:
- 10mm THK. HEAT STRENGTHENED GLASS (OUTSIDE) + 12mm AIR SPACE + 12mm THK. TEMPERED GLASS
  - 10mm THK. HEAT STRENGTHENED GLASS (OUTSIDE) + 12mm AIR SPACE + 10mm THK. TEMPERED GLASS
  - 12mm THK. HEAT STRENGTHENED GLASS
  - 12mm THK. CLEAR TEMPERED GLASS (INTERNAL PROTECTIVE BARRIER)
  - 12mm THK. CLEAR TEMPERED STRENGTHENED GLASS
  - 10mm THK. CLEAR TEMPERED GLASS
  - 8mm THK. CLEAR TEMPERED STRENGTHENED GLASS + 1.52mm THK. + 8mm THK. CLEAR HEAT-STRENGTHENED GLASS
  - 3 mm THK. ALUM. CLADDING
  - 3 mm THK. ALUM. BACKPAN
  - STACK JOINT

<p>DATE: 22-01-21</p> <p>SCALE: 1:50(A1)</p> <p>PROJECT: TYPICAL FLOOR PARTIAL ELEVATION &amp; SECTION, PLAN FOR CURTAIN WALL (TOWER 1)</p> <p>CLIENT: 德利發展有限公司 Sino Land Company Limited</p> <p>ARCHITECT: 6 partners Goulden &amp; Partners Goulden &amp; Partners (HK) Ltd. Goulden &amp; Partners (China) Co., Ltd.</p> <p>STRUCTURAL ENGINEER: Gammon</p> <p>MECHANICAL ENGINEER: AECOM</p> <p>ELECTRICAL ENGINEER: AECOM</p> <p>PROJECT NO.: J-838</p> <p>DESIGNED BY: [Signature]</p> <p>CHECKED BY: [Signature]</p> <p>DATE: 22-01-21</p> <p>SCALE: 1:50(A1)</p> <p>TITLE: TYPICAL FLOOR PARTIAL ELEVATION &amp; SECTION, PLAN FOR CURTAIN WALL (TOWER 1)</p> <p>PROJECT: INTEGRATED RESIDENTIAL DEVELOPMENT AT TOWER 209E PHASE 11, LIONS PARK, TSEUNG KWAN O, H.K.</p>	<p>1. ALL DIMENSIONS ARE IN MM.</p> <p>2. ALL DIMENSIONS ARE REVERSED FROM OUTSIDE UNLESS SPECIFIED OTHERWISE.</p> <p>3. ALL DIMENSIONS TO BE CHECKED ON SITE.</p> <p>4. REVERSED DETAIL.</p> <p>5. DETAIL WORK NO.</p> <p>6. REVERSED SHEET NO.</p> <p>7. F.L. - FINISHED FLOOR LEVEL.</p> <p>8. S.F.L. - STRUCTURAL FLOOR LEVEL.</p> <p>9. R.F.L. - REVERSED DETAIL.</p>	<p>BD. REF: T1BB BC</p>
--	--	-------------------------

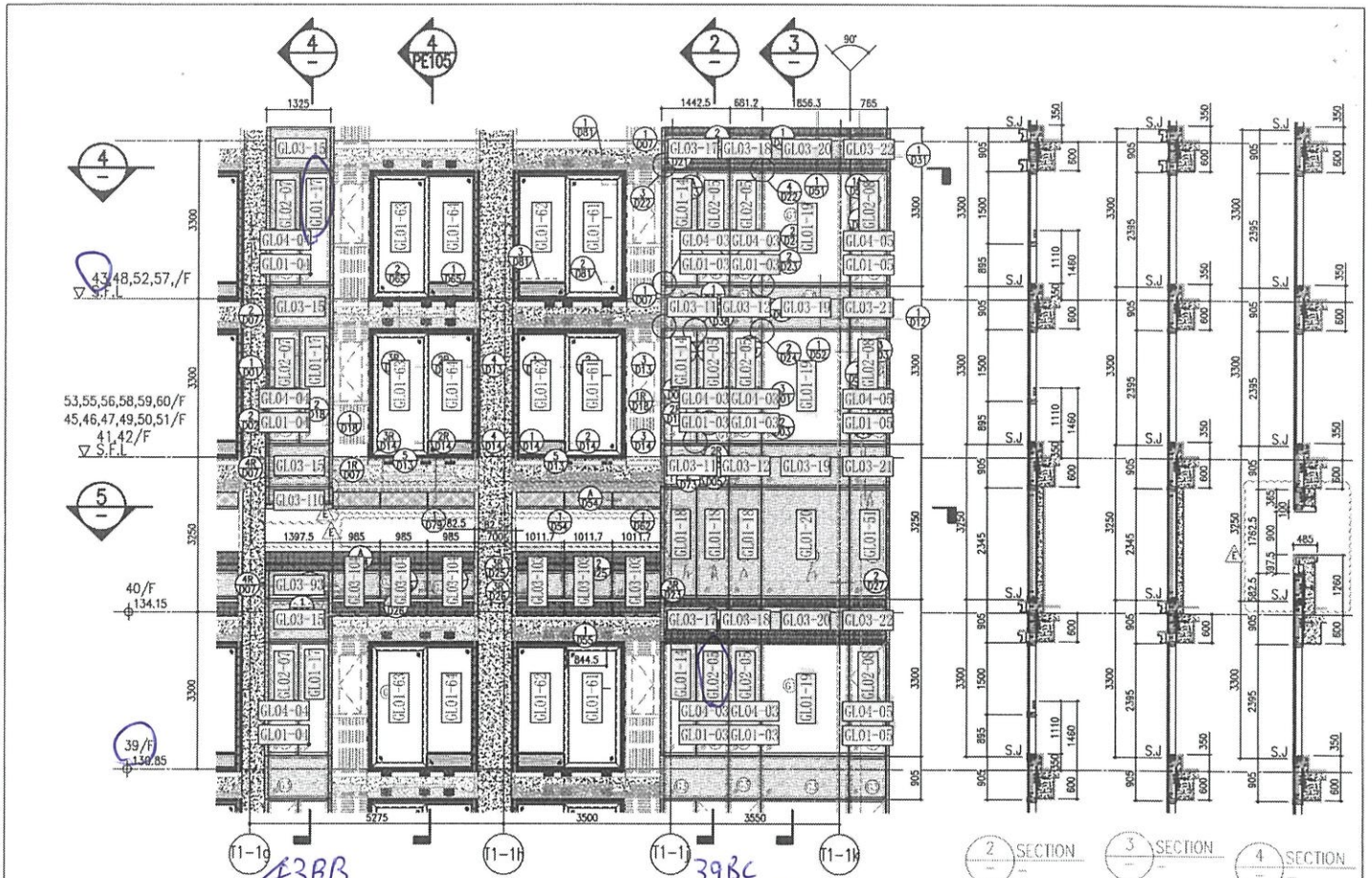

1 PART ELEVATION FOR CURTAIN WALL

2 SECTION 3 SECTION 4 SECTION

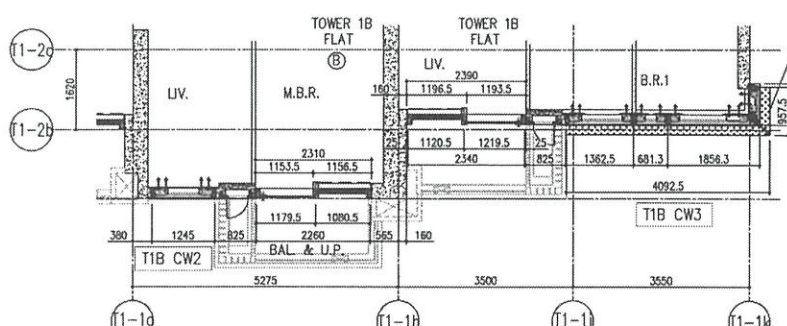

4 PART PLAN FOR CURTAIN WALL

ARCH. FEATURE AT 39/F, 43/F, 48/F, 52/F, 57/F

26/F	+91.25	39/F	+130.85	52/F	+170.40		
25/F	+87.95	38/F	+127.55	51/F	+167.10	R/F	+203.80
23/F	+84.65	37/F	+124.25	50/F	+163.80	52/F	+200.30
22/F	+81.35	36/F	+120.95	49/F	+160.50	61/F	+196.80
21/F	+78.05	35/F	+117.65	48/F	+157.20	60/F	+193.50
20/F	+74.75	33/F	+114.35	47/F	+153.90	59/F	+190.20
19/F	+71.45	32/F	+111.05	46/F	+150.60	58/F	+186.90
18/F	+68.15	31/F	+107.75	45/F	+147.30	57/F	+183.60
17/F	+64.85	30/F	+104.45	43/F	+144.00	56/F	+180.30
16/F	+61.55	29/F	+101.15	42/F	+140.70	55/F	+177.00
15/F	+58.25	28/F	+97.85	41/F	+137.40	53/F	+173.70
12/F	+54.95	27/F	+94.55	40/F	+134.15		

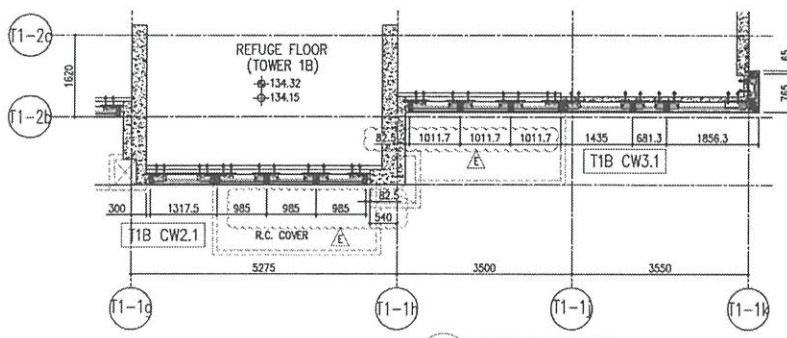

5 PART PLAN (40/F) FOR CURTAIN WALL

- LEGEND:**
- 10mm THK. HEAT STRENGTHENED GLASS (OUTSIDE) + 12mm AIR SPACE + 12mm THK. TEMPERED GLASS
  - 10mm THK. HEAT STRENGTHENED GLASS (OUTSIDE) + 12mm AIR SPACE + 10mm THK. TEMPERED GLASS
  - 12mm THK. HEAT STRENGTHENED GLASS
  - 12mm THK. CLEAR TEMPERED GLASS (INTERNAL PROTECTIVE BARRIER)
  - 12mm CLEAR HEAT STRENGTHENED GLASS
  - 10mm THK. CLEAR TEMPERED GLASS
  - 8mm THK CLEAR HEAT-STRENGTHENED GLASS + 15mm PVB + 8mm THK. CLEAR HEAT-STRENGTHENED GLASS
  - 3mm THK ALUM. CLADDING
  - 3mm THK ALUM. BACKPAN
  - STACK JOINT

DATE	22-OCT-21	SCALE	1:50(A1)
DRAWN BY		CHECKED BY	
<p>TITLE: TYPICAL FLOOR PARTIAL ELEVATION &amp; SECTION, PLAN FOR CURTAIN WALL (TOWER 1)</p>			
<p>PROJECT: PROPOSED RESIDENTIAL DEVELOPMENT AT TOWER 70P, PHASE 11, OASIS PARK, TSEUNG WAN O, N.T.</p>			
JOB NO.	J-858		
REV.		DATE	REASON
1		23/09/22	REVISED AS PER COMMENTS
2		09/04/22	REVISED AS PER COMMENTS
3		29/07/22	REVISED AS PER COMMENTS
4		29/07/22	REVISED AS PER COMMENTS
5		02/12/21	REVISED AS PER COMMENTS

**NOTE:**

1. ALL DIMENSIONS ARE IN METERS.
2. ALL DIMENSIONS ARE UNLESS OTHERWISE SPECIFIED.
3. ALL DIMENSIONS TO BE VERIFIED ON SITE BEFORE FABRICATION.

**LEGEND:**

- CENTER MARK NO.
- REVERSE SHEET NO.
- FINISHED FLOOR LEVEL.
- STRUCTURAL FLOOR LEVEL.
- REVERSED DETAIL.

FACE CONSULTANT: **AECOM**

STRUCTURAL ENGINEER: **Gammon**

ARCHITECT: **ronald lu & partners**  
 Ronald Lu & Partners (HK) Ltd.  
 香港建築師學會 (香港) 有限公司

MAIN CONTRACTOR: **Sino Land Company Limited**

BA REF: **T1BB BC**

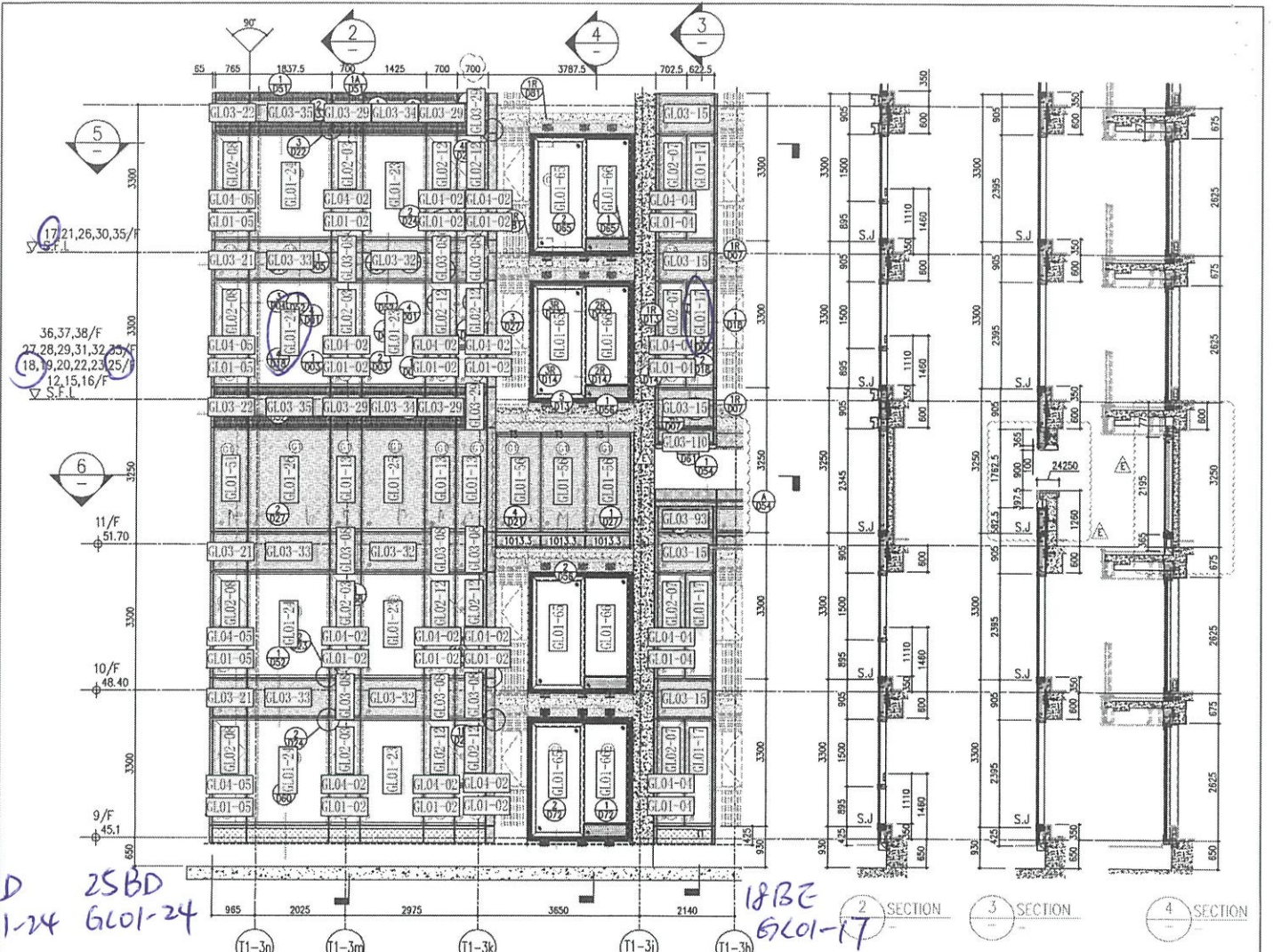

17BD  
GLO1-24

25BD  
GLO1-24

18BE  
GLO1-17

26/F	+91.25	39/F	+130.85	52/F	+170.40		
25/F	+87.95	38/F	+127.55	51/F	+167.10	R/F	+203.80
23/F	+84.65	37/F	+124.25	50/F	+163.80	62/F	+200.30
22/F	+81.35	36/F	+120.95	49/F	+160.50	61/F	+196.80
21/F	+78.05	35/F	+117.65	48/F	+157.20	60/F	+193.50
20/F	+74.75	33/F	+114.35	47/F	+153.90	59/F	+190.20
19/F	+71.45	32/F	+111.05	46/F	+150.60	58/F	+186.90
18/F	+68.15	31/F	+107.75	45/F	+147.30	57/F	+183.60
17/F	+64.85	30/F	+104.45	43/F	+144.00	56/F	+180.30
16/F	+61.55	29/F	+101.15	42/F	+140.70	55/F	+177.00
15/F	+58.25	28/F	+97.85	41/F	+137.40	40/F	+134.15
12/F	+54.95	27/F	+94.55				

ARCH. FEATURE AT 11/F, 17/F,  
21/F, 26/F, 30/F, 35/F

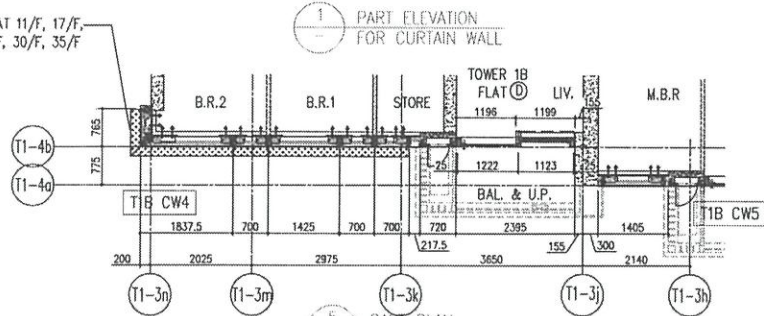

1 PART ELEVATION FOR CURTAIN WALL

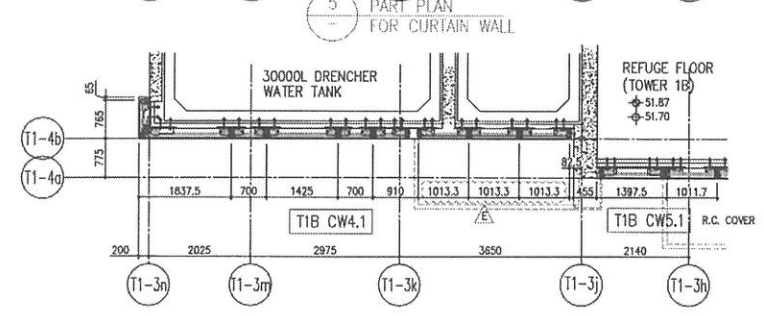

5 PART PLAN FOR CURTAIN WALL



6 PART PLAN (11/F) FOR CURTAIN WALL

**LEGEND:**

- 10mm THK. HEAT STRENGTHENED GLASS (OUTSIDE) + 12mm AIR SPACE + 12mm THK. TEMPERED GLASS
- 10mm THK. HEAT STRENGTHENED GLASS (OUTSIDE) + 12mm AIR SPACE + 10mm THK. TEMPERED GLASS
- 12mm THK. HEAT STRENGTHENED GLASS
- 12mm THK. CLEAR TEMPERED GLASS (INTERNAL PROTECTIVE BARRIER)
- 12mm CLEAR HEAT STRENGTHENED GLASS
- 10mm THK. CLEAR TEMPERED GLASS
- 8mm THK. CLEAR HEAT-STRENGTHENED GLASS + 152mm AIR SPACE + 8mm THK. CLEAR HEAT-STRENGTHENED GLASS
- 3mm THK. ALUM. CLADDING
- 3mm THK. ALUM. BACKPAN
- STACK JOINT

**DATE:** 22-03-21 **SCALE:** 1:50(A1)

**PROJECT:** PROPOSED RESIDENTIAL DEVELOPMENT AT TOWER 7, PHASE 1, LUMAS PARK (SECOND PHASE) Q. N. I.

**CLIENT:** 信和置业有限公司  
Sino Land Company Limited

**ARCHITECT:** Ronald Lu  
Ronald Lu & Partners (HK) Ltd.  
11/F, 110, Nathan Road, Kowloon, HONG KONG

**STRUCTURAL ENGINEER:** Gammon  
AECOM

**FACE CONSULTANT:** AECOM

**DATE:** 22-03-21

1. ALL DIMENSIONS ARE IN mm.  
2. ALL ELEVATIONS ARE VIEWED FROM OUTSIDE.  
3. ALL DIMENSIONS TO BE VERIFIED ON SITE BEFORE FABRICATION.

**LEGEND:**  
 DETAIL WORK NO.  
 REFER SHEET NO.  
 FLOOR LEVEL  
 STRUCTURAL FLOOR LEVEL  
 RINGED DETAIL

**REVISIONS:**

NO.	DATE	DESCRIPTION
1	21/03/21	ISSUED AS PER COMMENTS
2	22/03/21	ISSUED AS PER COMMENTS
3	23/03/21	ISSUED AS PER COMMENTS
4	24/03/21	ISSUED AS PER COMMENTS
5	25/03/21	ISSUED AS PER COMMENTS
6	26/03/21	ISSUED AS PER COMMENTS
7	27/03/21	ISSUED AS PER COMMENTS
8	28/03/21	ISSUED AS PER COMMENTS
9	29/03/21	ISSUED AS PER COMMENTS
10	30/03/21	ISSUED AS PER COMMENTS
11	31/03/21	ISSUED AS PER COMMENTS
12	01/04/21	ISSUED AS PER COMMENTS
13	02/04/21	ISSUED AS PER COMMENTS
14	03/04/21	ISSUED AS PER COMMENTS
15	04/04/21	ISSUED AS PER COMMENTS

**DR:** J. B. B. **CHK:** E



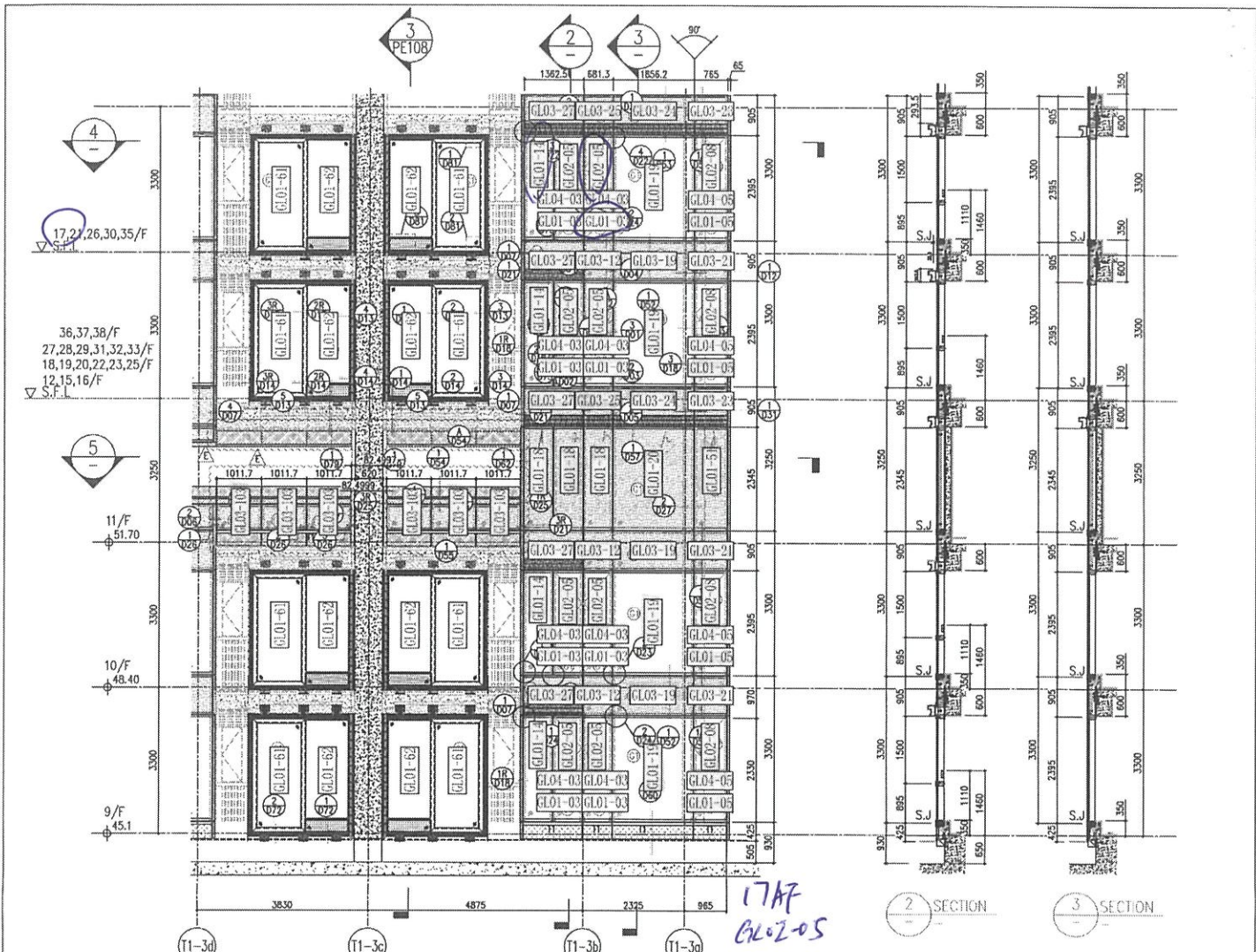

1 PART ELEVATION FOR CURTAIN WALL

17AF  
GL02-05  
GL01-03  
GL01-14

26/F	+91.25	39/F	+130.89	52/F	+170.40	R/F	+203.80
25/F	+87.95	38/F	+127.55	51/F	+167.10	62/F	+200.30
23/F	+84.65	37/F	+124.25	50/F	+163.80	61/F	+196.80
22/F	+81.35	36/F	+120.95	49/F	+160.50	60/F	+193.50
21/F	+78.05	35/F	+117.65	48/F	+157.20	59/F	+190.20
20/F	+74.75	33/F	+114.35	47/F	+153.90	58/F	+186.90
19/F	+71.45	32/F	+111.05	46/F	+150.60	57/F	+183.60
18/F	+68.15	31/F	107.75	45/F	+147.30	56/F	+180.30
17/F	+64.85	30/F	+104.45	43/F	+144.00	55/F	+177.00
16/F	+61.55	29/F	+101.15	42/F	+140.70	53/F	+173.70
15/F	+58.25	28/F	+97.85	41/F	+137.40		
12/F	+54.95	27/F	+94.55	40/F	+134.10		

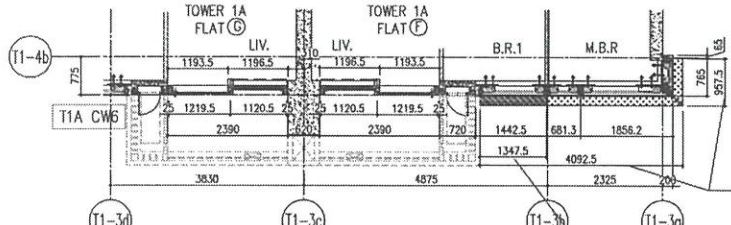

4 PART PLAN FOR CURTAIN WALL

ARCH. FEATURE AT 11/F, 17/F, 21/F, 26/F, 30/F, 35/F,  
ARCH. FEATURE AT 9/F, 10/F, 12/F, 15/F-16/F, 18/F-20/F, 22/F, 23/F, 25/F, 27/F-29/F, 31/F-33/F, 36/F-38/F.

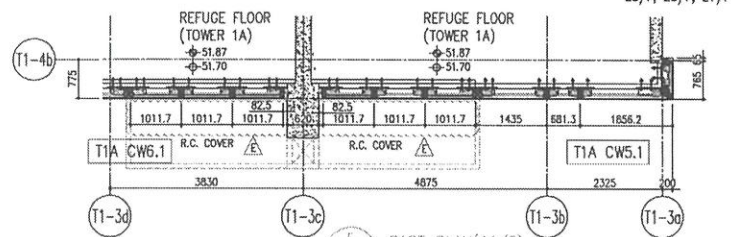

5 PART PLAN (11/F) FOR CURTAIN WALL

LEGEND:

- 10mm THK HEAT STRENGTHENED GLASS (OUTSIDE) + 12mm AIR SPACE + 12mm THK TEMPERED GLASS
- 10mm THK HEAT STRENGTHENED GLASS (OUTSIDE) + 12mm AIR SPACE + 10mm THK TEMPERED GLASS
- 12mm THK HEAT STRENGTHENED GLASS
- 12mm THK CLEAR TEMPERED GLASS (INTERNAL PROTECTIVE BARRIER)
- 12mm CLEAR HEAT STRENGTHENED GLASS
- 10mm THK CLEAR TEMPERED GLASS
- 8mm THK CLEAR HEAT-STRENGTHENED GLASS + 15mm AIR SPACE + 8mm THK CLEAR HEAT-STRENGTHENED GLASS
- 3mm THK ALUM. CLADDING
- 3mm THK ALUM. BACKPAN
- STACK JOINT

**ME:**

- ALL DIMENSIONS ARE IN mm.
- ALL DIMENSIONS ARE VERIFIED FROM OUTSIDE.
- ALL DIMENSIONS ARE VERIFIED ON SITE.
- BEFORE FABRICATION.

**LEGEND:**

- REVISION MARK NO.
- REVISION SHEET NO.
- FINISHED FLOOR LEVEL
- STRUCTURAL FLOOR LEVEL
- REVERSED DENIAL

**DATE:** 22-05-21

**SCALE:** 1:50(A1)

**TITLE:** TYPICAL FLOOR PARTIAL ELEVATION & SECTION, PLAN FOR CURTAIN WALL (TOWER 1)

**PROJECT:** PROPOSED RESIDENTIAL DEVELOPMENT AT TOWER 1, LUNGS PARK TSEUNG KWAN O, N.T.

**JOB NO.:** J-858

**DESIGNER:** J-858

**CHECKED BY:**

**DRAWN BY:**

**DATE:** 22-05-21

**SCALE:** 1:50(A1)

**PROJECT:** PROPOSED RESIDENTIAL DEVELOPMENT AT TOWER 1, LUNGS PARK TSEUNG KWAN O, N.T.

**JOB NO.:** J-858

**DESIGNER:** J-858

**CHECKED BY:**

**DRAWN BY:**

**STRUCTURAL ENGINEER:**

**GAMMON**

**REGISTERED CONSULTANT:**

**AECOM**

**REGISTERED ARCHITECT:**

**RONALDU & PARTNERS**

**REGISTERED ARCHITECT:**

**RONALDU & PARTNERS (HK) LTD.**

**REGISTERED ARCHITECT (HONG KONG):** 4042

**MAIN CONTRIBUTOR:**

**CLIENT:** 信和置業有限公司  
Sino Land Company Limited

**DATE:** 22-05-21

**SCALE:** 1:50(A1)

**TITLE:** TYPICAL FLOOR PARTIAL ELEVATION & SECTION, PLAN FOR CURTAIN WALL (TOWER 1)

**PROJECT:** PROPOSED RESIDENTIAL DEVELOPMENT AT TOWER 1, LUNGS PARK TSEUNG KWAN O, N.T.

**JOB NO.:** J-858

**DESIGNER:** J-858

**CHECKED BY:**

**DRAWN BY:**

**DATE:** 22-05-21

**SCALE:** 1:50(A1)

**PROJECT:** PROPOSED RESIDENTIAL DEVELOPMENT AT TOWER 1, LUNGS PARK TSEUNG KWAN O, N.T.

**JOB NO.:** J-858

**DESIGNER:** J-858

**CHECKED BY:**

**DRAWN BY:**

TI AF

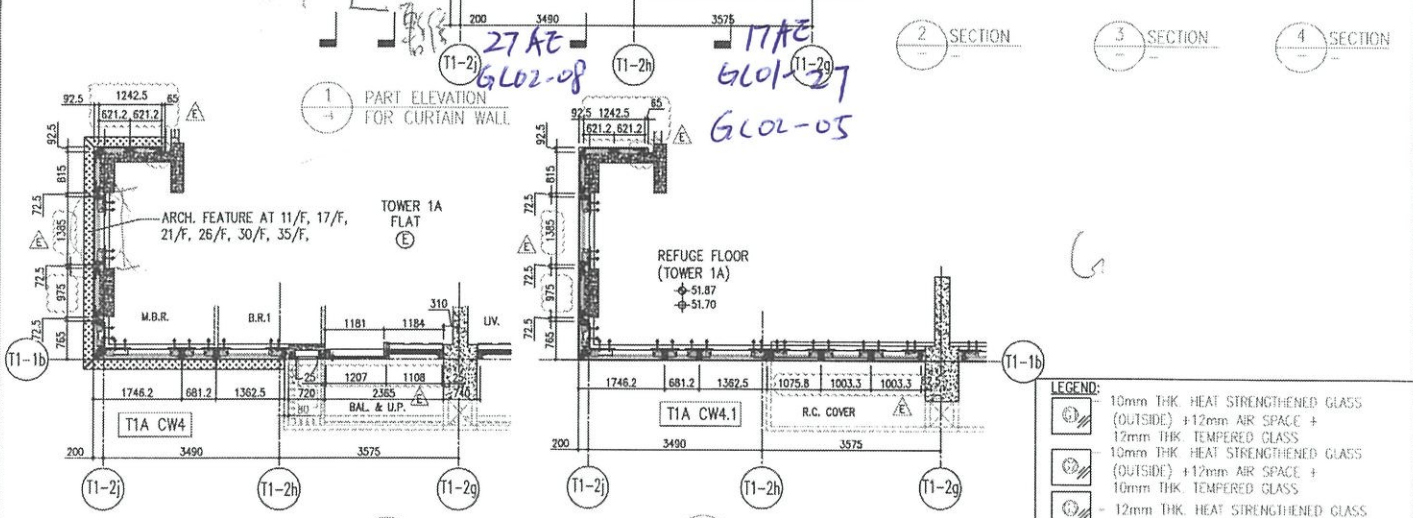
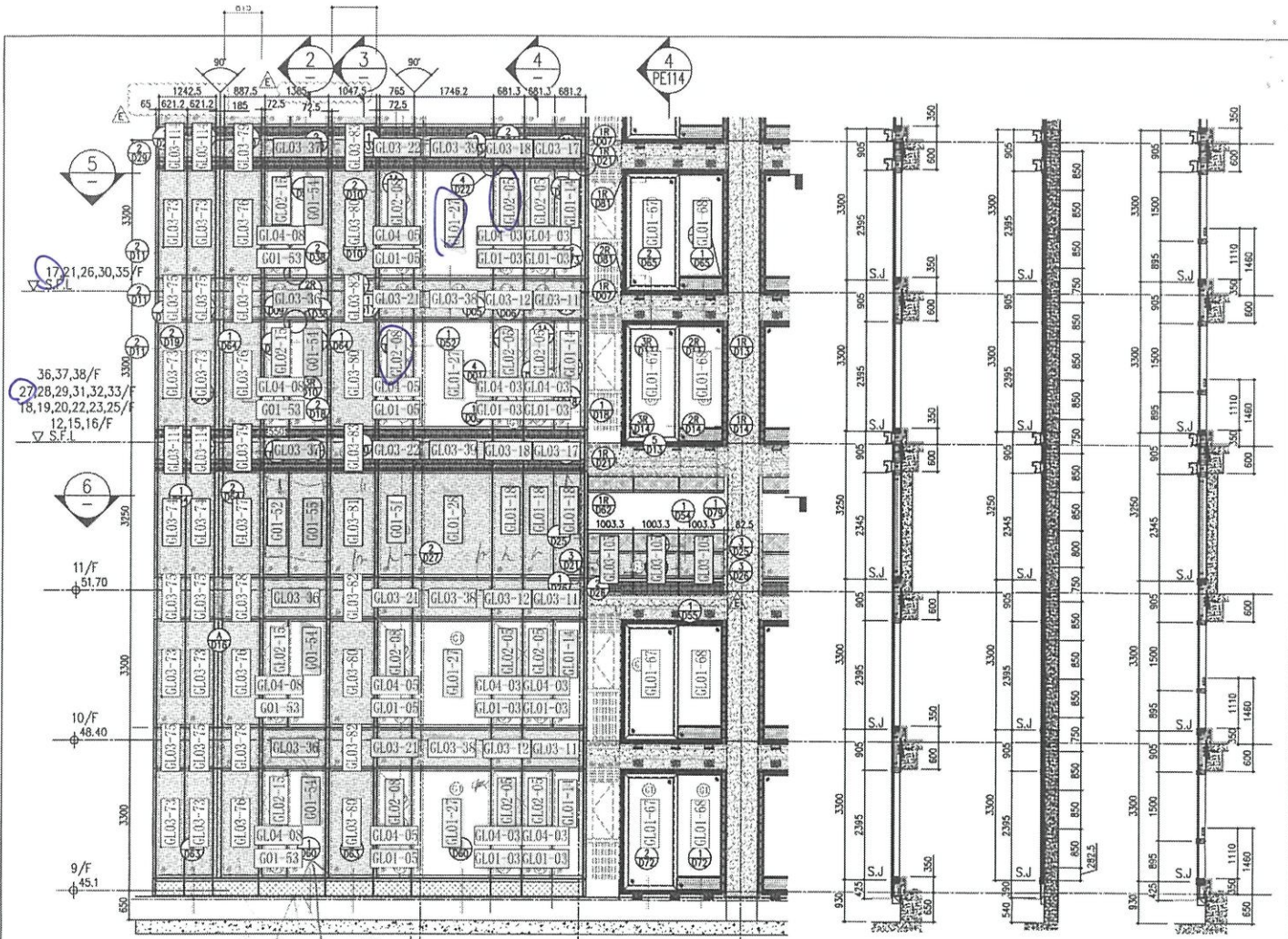

26/F +91.25	39/F +130.85	52/F +170.40	R/F +203.80
25/F +87.95	38/F +127.55	51/F +167.10	50/F +163.80
23/F +84.65	37/F +124.25	49/F +160.50	62/F +200.30
22/F +81.35	36/F +120.95	48/F +157.20	61/F +196.80
21/F +78.05	35/F +117.65	47/F +153.90	60/F +193.50
20/F +74.75	33/F +114.35	46/F +150.60	59/F +190.20
19/F +71.45	32/F +111.05	45/F +147.30	58/F +186.90
18/F +68.15	31/F +107.75	44/F +144.00	57/F +183.60
17/F +64.85	30/F +104.45	43/F +140.70	56/F +180.30
16/F +61.55	29/F +101.15	42/F +137.40	55/F +177.00
15/F +58.25	28/F +97.85	41/F +134.10	54/F +173.70
12/F +54.95	27/F +94.55	40/F +130.80	

- LEGEND:**
- 10mm THK HEAT STRENGTHENED GLASS (OUTSIDE) +12mm AIR SPACE + 12mm THK TEMPERED GLASS
  - 10mm THK HEAT STRENGTHENED GLASS (OUTSIDE) +12mm AIR SPACE + 10mm THK TEMPERED GLASS
  - 12mm THK HEAT STRENGTHENED GLASS
  - 12mm THK CLEAR TEMPERED GLASS ( INTERNAL PROTECTIVE BARRIER )
  - 10mm BLUE TINTED HEAT STRENGTHENED GLASS
  - 10mm THK CLEAR TEMPERED GLASS
  - 8mm THK CLEAR HEAT STRENGTHENED GLASS +152mm AIR SPACE + 8mm THK CLEAR HEAT-STRENGTHENED GLASS
  - 3 mm THK ALUM. GLASSING
  - 3 mm THK ALUM. BACKPAN
  - S.J. - STACK JOINT

<p><b>REVISIONS</b></p> <table border="1"> <tr> <th>NO.</th> <th>DATE</th> <th>REVISION</th> </tr> <tr> <td>1</td> <td>09/12/21</td> <td>REVISED AS PER COMMENTS</td> </tr> <tr> <td>2</td> <td>17/02/22</td> <td>REVISED AS PER COMMENTS</td> </tr> <tr> <td>3</td> <td>17/02/22</td> <td>REVISED AS PER COMMENTS</td> </tr> <tr> <td>4</td> <td>20/12/21</td> <td>REVISED AS PER COMMENTS</td> </tr> <tr> <td>5</td> <td>09/12/21</td> <td>REVISED AS PER COMMENTS</td> </tr> </table>	NO.	DATE	REVISION	1	09/12/21	REVISED AS PER COMMENTS	2	17/02/22	REVISED AS PER COMMENTS	3	17/02/22	REVISED AS PER COMMENTS	4	20/12/21	REVISED AS PER COMMENTS	5	09/12/21	REVISED AS PER COMMENTS	<p><b>DATE:</b> 22-01-21</p> <p><b>SCALE:</b> 1:50(A1)</p> <p><b>TITLE:</b> TYPICAL FLOOR PARTIAL ELEVATION &amp; SECTION, PLAN FOR CURTAIN WALL (TOWER 1)</p>	<p><b>PROJECT:</b> PROPOSED RESIDENTIAL DEVELOPMENT AT TOWER 1, PHASE 1, JOMAS PARK, TSEUNG KWAN O, H.K.</p>	<p><b>CLIENT:</b> 信和置業有限公司 Sino Land Company Limited</p>	<p><b>ARCHITECT:</b> Ronald Yu &amp; Partners Ronald Yu &amp; Partners (HK) Ltd. 信和建築師事務所(香港)有限公司</p>	<p><b>STRUCTURAL ENGINEER:</b> Gammon <b>AECOM</b></p>	<p><b>FACE CONSULTANT:</b> <b>AECOM</b></p>	<p><b>DATE:</b> 22-01-21</p> <p>1. ALL DIMENSIONS ARE IN MM.</p> <p>2. ALL ELEVATIONS ARE VIEWED FROM OUTSIDE.</p> <p>3. ALL DIMENSIONS TO BE TIERED ON SITE BEFORE FABRICATION.</p> <p><b>LEGEND:</b></p> <p>(N) - DETAIL MARK NO.</p> <p>(S) - RETIER SHEET NO.</p> <p>1. F.F.L. - FINISHED FLOOR LEVEL.</p> <p>2. S.F.L. - STRUCTURAL FLOOR LEVEL.</p> <p>3. - REVERSED DETAIL.</p>
	NO.	DATE	REVISION																						
1	09/12/21	REVISED AS PER COMMENTS																							
2	17/02/22	REVISED AS PER COMMENTS																							
3	17/02/22	REVISED AS PER COMMENTS																							
4	20/12/21	REVISED AS PER COMMENTS																							
5	09/12/21	REVISED AS PER COMMENTS																							
<p><b>DRWN BY:</b> MDDI</p> <p><b>CHECKED BY:</b></p> <p><b>DATE:</b> 22-01-21</p>	<p><b>BA. REF.:</b> T1 AE</p>																								

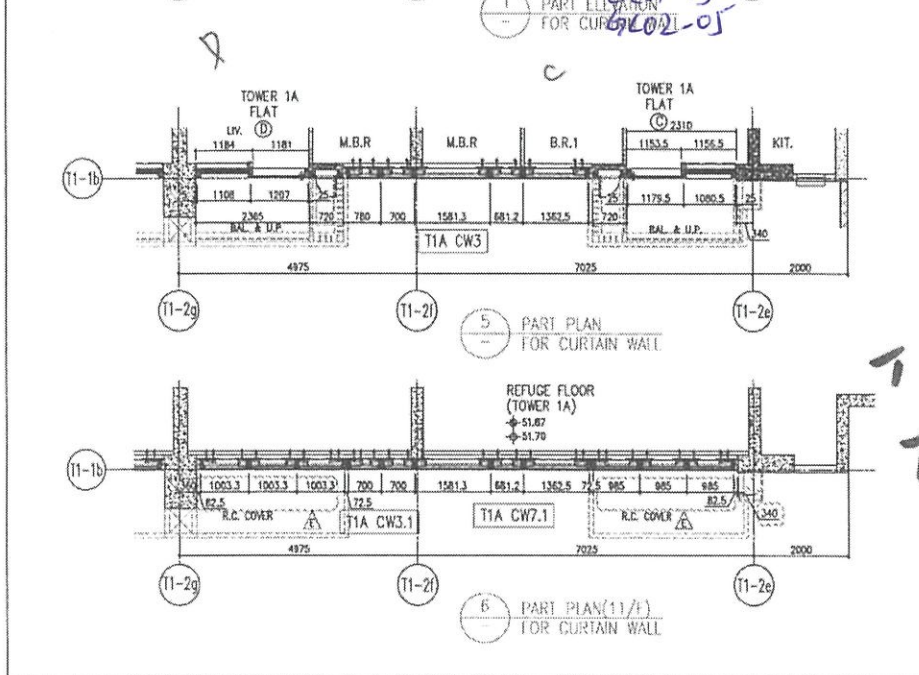
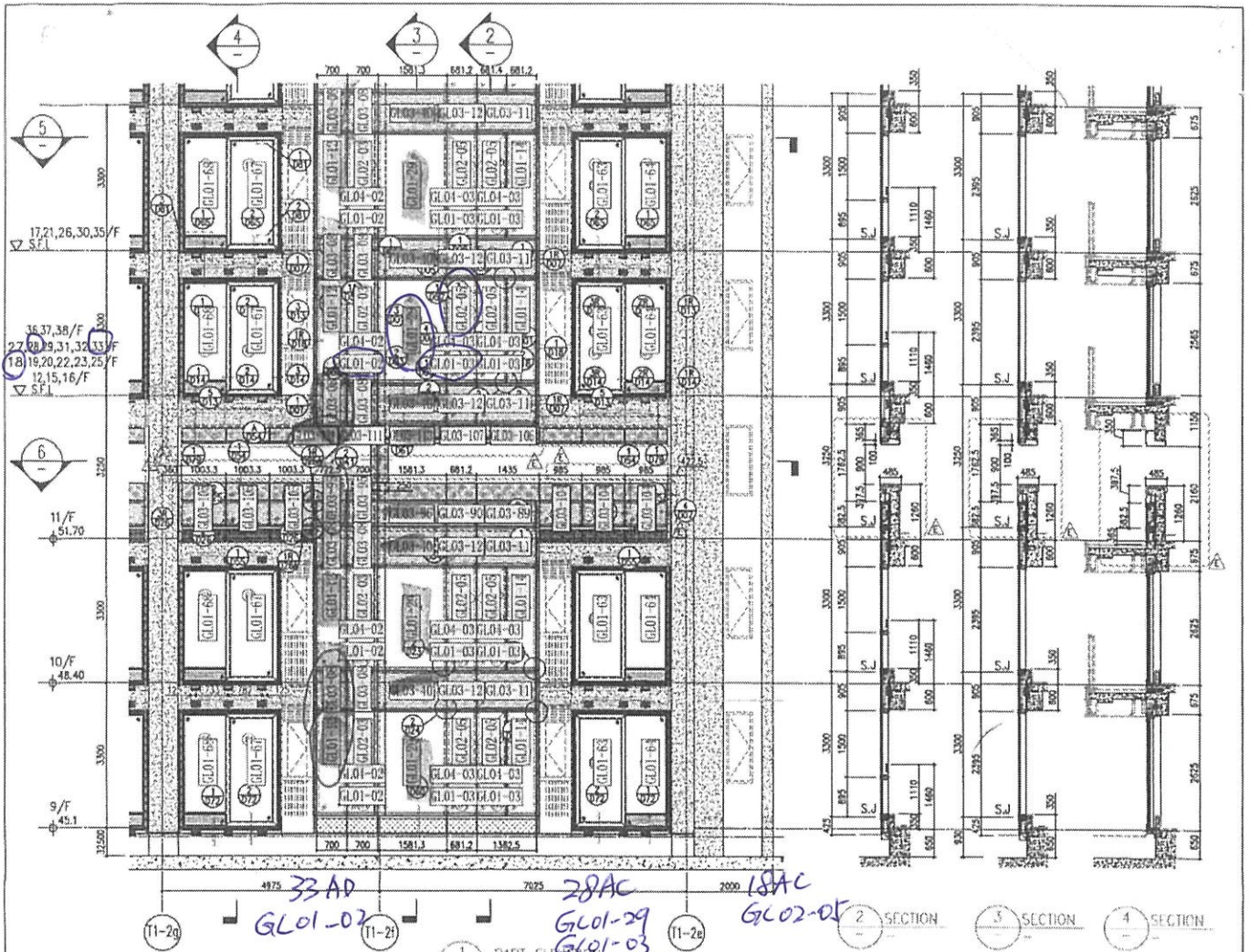

26/F +91.25	39/F +130.85	52/F +170.40	
25/F +87.95	38/F +127.55	51/F +167.10	R/F +203.88
23/F +84.65	37/F +124.25	50/F +163.80	62/F +200.38
22/F +81.35	36/F +120.95	49/F +160.50	61/F +196.88
21/F +78.05	35/F +117.65	48/F +157.20	60/F +193.50
20/F +74.75	33/F +114.35	47/F +153.90	59/F +190.20
19/F +71.45	32/F +111.05	46/F +150.60	58/F +186.90
18/F +68.15	31/F 107.75	45/F +147.30	57/F +183.68
17/F +64.85	30/F +104.45	43/F +144.00	56/F +180.38
16/F +61.55	29/F +101.15	42/F +140.70	55/F +177.00
15/F +58.25	28/F +97.85	41/F +137.40	
12/F +54.95	27/F +94.55	40/F +134.15	53/F +173.70

- LEGEND:**
- 10mm THK. HEAT STRENGTHENED GLASS (INSIDE) + 12mm AIR SPACE + 10mm THK. TEMPERED GLASS (OUTSIDE)
  - 10mm THK. HEAT STRENGTHENED GLASS (INSIDE) + 12mm AIR SPACE + 10mm THK. CLEAR TEMPERED GLASS (OUTSIDE)
  - 10mm THK. CLEAR TEMPERED GLASS (INSIDE) + 12mm AIR SPACE + 10mm THK. HEAT STRENGTHENED GLASS (OUTSIDE)
  - 10mm THK. BLUE TINTED HEAT STRENGTHENED GLASS (INSIDE) + 12mm AIR SPACE + 10mm THK. CLEAR TEMPERED GLASS (OUTSIDE)
  - 10mm THK. CLEAR TEMPERED GLASS (INSIDE) + 12mm AIR SPACE + 10mm THK. CLEAR TEMPERED GLASS (OUTSIDE)
  - 8mm THK. CLEAR HEAT STRENGTHENED GLASS + 1.52mm AIR SPACE + 8mm THK. CLEAR HEAT STRENGTHENED GLASS
  - 3mm THK. ALUM. CLADDING
  - 3mm THK. ALUM. BACKPAN
  - STACK JOINT

**PROJECT:** PROPOSED RESIDENTIAL DEVELOPMENT AT TOWER 2099, PHASE 11, LOHAS PARK, TIANJIN, CHINA.

**DATE:** 22-OCT-21

**SCALE:** 1:150(A1)

**DESIGNER:** AECOM

**CHECKER:** [Signature]

**TITLE:** TYPICAL FLOOR PARTIAL ELEVATION & SECTION PLAN FOR CURTAIN WALL (TOWER 1)

**NO.:** 1-635

**PROJECT:** PROPOSED RESIDENTIAL DEVELOPMENT AT TOWER 2099, PHASE 11, LOHAS PARK, TIANJIN, CHINA.

**REVISIONS:**

NO.	DATE	DESCRIPTION
1	11/09/21	ISSUED AS PER COMMENTS
2	09/04/22	REVISED AS PER COMMENTS
3	11/22/21	REVISED AS PER COMMENTS
4	20/12/21	REVISED AS PER COMMENTS
5	02/17/21	REVISED AS PER COMMENTS

**NOTES:**

- ALL DIMENSIONS ARE IN mm.
- ALL DIMENSIONS ARE UNLESS OTHERWISE SPECIFIED.
- ALL DIMENSIONS TO BE CHECKED ON SITE BEFORE PROCEEDING.

**LEGEND:**

- F.F.L. - FINISHED FLOOR LEVEL
- S.F.L. - STRUCTURAL FLOOR LEVEL
- R.F.L. - REFINISHED FLOOR LEVEL

**CLIENT:** 信達物業發展有限公司  
Shin Land Company Limited

**ARCHITECT:** Ronald Lu & Partners (HK) Ltd.  
羅爾達建築師事務所 (香港) 有限公司

**STRUCTURAL ENGINEER:** Gammon

**MECHANICAL ENGINEER:** AECOM

**ELECTRICAL ENGINEER:** AECOM

**PLUMBING ENGINEER:** AECOM

**MECHANICAL CONTRACTOR:** [Name]

**MECHANICAL CONTRACTOR:** [Name]

**DATE:** 22-OCT-21

**SCALE:** 1:150(A1)

**DESIGNER:** AECOM

**CHECKER:** [Signature]

TI AC AP

玻璃記錄

地盤名稱：日出康城11期

件數

已換日期	座數	單位	工作範圍	內/外	分類
29/5	✓	59AE	主安全 2件		2
29/5	✓	58AE	房安全+主轉角		2
		58BC	房門框		1
		..	房門玉		1
	✓	57BC	安全 3件		3
	E18952B	56AD	房細框	內外	1
	✓	56BD	房2房安全		2
	E18952B	51AA	房1細框	外崩	1
27/5	已換 ✓	50AC	主安全		1
	✓	50AG	房1安全		1
		49BD	房2細框	內外	1
	大邊	..	房門玉	內外	1
	大邊	49BA	主細框	內	1
		48BD	廚房	外崩	1
	✓	48BC	主轉角安全		1
	E18943A	47BD	廚房	外崩	1
	✓	46AD	房安全		1
	✓	45AC	主安全		1
	✓	43BC	主轉角+房安全		2
	E18952	43BD	主大框	外崩	1
	E18952	..	主轉角生窗	外崩	1
27/5	已換 ✓	42AC	房1生窗		1
	E18952B大邊	42BC	主轉角細框	外花	1
27/5	已換 ✓	..	房安全		1
	E18943	42BB	房門玉	內	1
		41BA	主生窗	內	1
	E18952 大邊	41BD	房1大框	內	1
27/5	已換 ✓	41BB	房安全	內外	1
	E18938B	41BC	主大框	外崩	1
	E18938B	..	房1細框	外崩	1

地盤代表簽名：\_\_\_\_\_

日期：\_\_\_\_\_

玻璃記錄

地盤名稱：日出康城11期

日期	座數	單位	工作範圍	內/外	分類
	E18952	41AE	主則大櫃	外崩	1
	E18952B	39BB	房生窗	外	1
	E18952	39AG	房1生窗	外	1
	已換 ✓	39AF	主轉角安全		1
	E18938A	37AF	房1細櫃	泡	1
		37BD	廚房	外崩	1
	E18952	36BB	房生窗	外崩	1
27/5	已換 ✓	36AC	房1+主安全		2
		36AB	廚房	外崩	
	E18952	35AD	房細櫃	內外	1
	E18952	35AB	主則大櫃	外崩	1
	E18938	35AC	主大櫃	外崩	1
	E18952	33AD	房生窗	外崩	1
		"	房細櫃	內外	1
	E18952A	33AB	主正面大櫃	外崩	1
27/5	已換 ✓	33AF	主正安全		1
		32AA	主大櫃	外崩	1
		"	房1大櫃	深老外	1
		"	厅同系	外崩	1
		"	厅櫃	外崩	1
27/5	已換 ✓	32AF	主安全+房		3
	E18952	32BD	主正面細櫃	外崩	1
	E18952A	32AE	房1生窗	"	1
	E18952	30BE	房生窗	外崩	1
29/5	✓	30AG	房1安全		1
	E18952	29BE	房生窗	外崩	1
	E18952	"	"細櫃	"	1
	E18938A	29AF	主轉角生窗	"	1
	✓	29BB	房安全		1
	E18938	29BD	房2細櫃	"	1

地盤代表簽名：\_\_\_\_\_

日期：\_\_\_\_\_

玻璃記錄

地盤名稱：日出康城11期

日期	座數	單位	工作範圍	內/外	分類
	✓	29BF	房安全		1
27/5	2換 ✓	28BD	至正面安全		1
		28AC	至大櫃 ✓	焊	1
		"	至細櫃 ✓	焊	1
		"	至生窗 ✓	焊	1
	?	"	至門玉	內外	1
27/5	2換 ✓	28BA	房安全		1
		27AE	至轉角生窗 ✓	外筋	1
	E18952	27BB	房生窗 ✓	"	1
	✓	27BA	房安全		2
	E18938A	27AF	房生窗 ✓		1
	E18938B	26AA	至大櫃 ✓	外筋	1
		25BD	至大櫃 ✓	內花/線	1
		"	厅門玉	外	1
		"	厨房	外	1
29/5	✓	25AG	至安全		1
	✓	25BC	至轉角+房安全	外筋	2
		25BC	厅櫃	"	1
	E18952	22BC	至正面細櫃 ✓	泡	1
	E18938A	22AF	至轉角細櫃 ✓	外筋	1
	太边	21BA	厅櫃	內花	1
		"	厅玉	內筋	1
	✓	21BC	至正面+房安全		2
29/5	✓	20AA	房安全		1
		20BB	房生窗 ✓	外筋	1
E18952	太边	20AE	至正內看左生窗	內外	1
	✓	20BD	房2安全		1
	E18952	20AC	至生窗 ✓	內外	1
	E18952	"	房1生窗 ✓	內	1
	E18952	"	房1大櫃 ✓	內外	1

地盤代表簽名： \_\_\_\_\_

日期： \_\_\_\_\_

玻璃記錄

地盤名稱：日出康城11期

日期	座數	單位	工作範圍	內/外	分類
	E18952	20AC	房1 細櫃 ✓	外筋	1
	E18938	20AB	主臥大櫃 ✓	外筋	
	✓	20BC	房安全		3
29/5	✓	19BA	房安全		2
	已換 ✓	19BD	房2 安全		1
	E18938B	19BE	房大櫃 ✓	外筋	1
	已換 ✓	19BC	房安全		3
		19AF	主正窗 生窗 ✓	外筋	1
		"	" 細櫃 ✓	外筋	1
	✓ 已換	"	" 安全	"	1
		"	房1 大櫃 ✓	"	1
		18BE	房大櫃 ✓	"	1
	已換 ✓	18BA	房1 安全		1
	已換 ✓	18AA	房1 安全		1
		18AC	主生窗 ✓	內筋	1
	✓	"	主正窗 + 房1 安全		2
		17AE	主大櫃 ✓	外筋	1
			主正窗 生窗 ✓	外筋	1
	✓	17BC	房安全		3
	E18943	17BF	厅玉	外筋	1
	E18938B	17AD	房大櫃 ✓	"	1
	E18943	"	厅玉	內外	1
		17BD	主大櫃 ✓	混內外	1
		16BE	厅玉	口合	1
	E18952	16AB	主臥 生窗 ✓	外筋	1
	✓	16AE	房1 安全		1
	✓	16BB	房安全		1
	E18943B	16BA	厅玉	口合	1
	E18938B	16AD	房生窗 ✓	外筋	
	✓	15AA	房1 安全		1

地盤代表簽名：\_\_\_\_\_

日期：\_\_\_\_\_

P.4

