



圖則登記表  
DRAWING REGISTER

工程名稱 Project Title:	康城11期 頂樓格柵 (工厂) (T1, 2, 3)
工程編號 Project No:	J858

分發予 Distributed To

圖則編號 Drg. No.	圖則名稱 Drawing Title
J858-ACG-MK2101	工地派位图
J858-ACG-MK2102	工地派位图
J858-ACG-MK2103	工地派位图
J858-ACG-MK2104	工地派位图
J858-ACG-MK2201	工地派位图
J858-ACG-MK2202	工地派位图
J858-ACG-MK2203	工地派位图
J858-ACG-MK2204	工地派位图
J858-ACG-MK2301	工地派位图
J858-ACG-MK2302	工地派位图
J858-ACG-MK2303	工地派位图
J858-ACG-MK2304	工地派位图
J858-AG-R01	格柵组裝图
J858-AG-R02	格柵组裝图
J858-AG-R03	格柵组裝图
J858-AG-R04	格柵组裝图
J858-AG-R05	格柵组裝图
J858-AG-R06	格柵组裝图
J858-AG-R07	格柵组裝图
J858-AG-R08	格柵组裝图
J858-AG-R09	格柵组裝图
J858-AG-R10	格柵组裝图
J858-AG-R11	格柵组裝图
J858-AG-R12	格柵组裝图
J858-AG-R13	格柵组裝图
J858-AG-R14	格柵组裝图
J858-AG-R15	格柵组裝图
J858-AG-R16	格柵组裝图
J858-AG-R17	格柵组裝图
J858-AG-R18	格柵组裝图
J858-AG-R19	格柵组裝图
J858-AG-R20	格柵组裝图

接收日期 Receiving Date (適用於客戶圖則)

年							
月							
日							

發出日期 Issued Date

年	23						
月	11						
日	27						

修訂編號  
Revision No.

1	-						
2	-						
3	-						
4	-						
5	-						
6							
7	-						
8	-						
9	-						
10	-						
11	-						
12	-						
13	-						
14	-						
15	-						
16	-						
17	-						
18	-						
19	-						
20	-						
21	-						
22	-						
23	-						
24	-						
25	-						
26	-						
27	-						
28	-						
29	-						
30	-						
31	-						
32	-						

圖則登記表  
DRAWING REGISTER

工程名稱 Project Title:	康城11期 頂樓格柵 (工厂) (T1, 2, 3)
工程編號 Project No:	J858

分發予 Distributed To

圖則編號 Drg. No.	圖則名稱 Drawing Title
X86361-G01	格柵加工图
X86361-G02	格柵加工图
X86361-G03	格柵加工图
X86361-G04	格柵加工图
X86361-G05	格柵加工图
X86361-G06	格柵加工图
X86361-G07	格柵加工图
X86361-G08	格柵加工图
X86362-G01	格柵加扣盖工图
X86362-G02	格柵加扣盖工图
X86362-G03	格柵加扣盖工图
X86362-G04	格柵加扣盖工图
X86362-G05	格柵加扣盖工图

接收日期 Receiving Date (適用於客戶圖則)

年							
月							
日							

發出日期 Issued Date

年	23						
月	11						
日	27						

修訂編號  
Revision No.

33	-						
34	-						
35	-						
36	-						
37	-						
38	-						
39	-						
40	-						
41	-						
42	-						
43	-						
44	-						
45	-						

## 工序明细表

工程名称		J-858(康城11期)					施工分区(批次) :		顶楼格栅(T1,T2,T3)	
采购原因		正常采购	工序号			材料发送地:		地盘		
序号	名称	组装件编号	图纸编号	长度L (mm)	宽度W (mm)	厚度T (mm)	数量	单位	备注	
1	格栅组装	J858-AG-R01	J858-AG-R01	1292	1583	163	1	窗	送地盘	
2	格栅组装	J858-AG-R02	J858-AG-R02	1292	1583	163	1	窗	送地盘	
3	格栅组装	J858-AG-R03	J858-AG-R03	1292	1573	163	1	窗	送地盘	
4	格栅组装	J858-AG-R04	J858-AG-R04	1292	1573	163	1	窗	送地盘	
5	格栅组装	J858-AG-R05	J858-AG-R05	1292	1273	163	1	窗	送地盘	
6	格栅组装	J858-AG-R06	J858-AG-R06	1292	1273	163	1	窗	送地盘	
7	格栅组装	J858-AG-R07	J858-AG-R07	1292	1298	163	2	窗	送地盘	
8	格栅组装	J858-AG-R08	J858-AG-R08	1292	1298	163	2	窗	送地盘	
9	格栅组装	J858-AG-R09	J858-AG-R09	1292	1623	163	1	窗	送地盘	
10	格栅组装	J858-AG-R10	J858-AG-R10	1292	1623	163	1	窗	送地盘	
11	格栅组装	J858-AG-R11	J858-AG-R11	1292	1498	163	1	窗	送地盘	
12	格栅组装	J858-AG-R12	J858-AG-R12	1292	1498	163	1	件	送地盘	
13	格栅组装	J858-AG-R13	J858-AG-R13	1292	1350	163	2	件	送地盘	
14	格栅组装	J858-AG-R14	J858-AG-R14	1292	1345	163	2	件	送地盘	
15	格栅组装	J858-AG-R15	J858-AG-R15	1292	1551	163	1	件	送地盘	
16	格栅组装	J858-AG-R16	J858-AG-R16	1292	741	163	2	件	送地盘	
17	格栅组装	J858-AG-R17	J858-AG-R17	1292	641	163	1	件	送地盘	
18	格栅组装	J858-AG-R18	J858-AG-R18	1292	1577	163	2	件	送地盘	
19	格栅组装	J858-AG-R19	J858-AG-R19	1292	550	163	1	件	送地盘	
20	格栅组装	J858-AG-R20	J858-AG-R20	1292	1400	163	1	件	送地盘	
21						汇总	26			
22										
23										
24										
25										
26										
27										
28										
29										
30										
31										
32										
33										
34										
35										
36										
37										
38										
39										
40										
41										
42										
43										
44										
45										
46										
47										
48										
以下空白										
说明: 1:注意保护成品, 严禁刻痕、划伤;										
设计:			校对:			审核:				

### 加工明细表

工程名称		J-858(康城11期)				施工分區(批次) :			顶楼格栅铝料
采购原因		正常采购	工序号		材料发送地:		工厂		
序列号	型材模号	物料描述	图号	部件编号	长度 (mm)	数量	单位	颜色	备注
1	X86361	格栅	X86361-G01	X86361-G01-01	1574	16	件	香槟金 (ECD3X1009 9S-XF1)	
2	X86361	格栅	X86361-G01	X86361-G01-02	1564	16	件	香槟金 (ECD3X1009 9S-XF1)	
3	X86361	格栅	X86361-G01	X86361-G01-03	1264	16	件	香槟金 (ECD3X1009 9S-XF1)	
4	X86361	格栅	X86361-G01	X86361-G01-04	1289	32	件	香槟金 (ECD3X1009 9S-XF1)	
5	X86361	格栅	X86361-G01	X86361-G01-05	1614	16	件	香槟金 (ECD3X1009 9S-XF1)	
6	X86361	格栅	X86361-G01	X86361-G01-06	1489	16	件	香槟金 (ECD3X1009 9S-XF1)	
7	X86361	格栅	X86361-G01	X86361-G01-07	1341.5	32	件	香槟金 (ECD3X1009 9S-XF1)	
8	X86361	格栅	X86361-G02	X86361-G02-01	1574	16	件	香槟金 (ECD3X1009 9S-XF1)	
9	X86361	格栅	X86361-G02	X86361-G02-02	1564	16	件	香槟金 (ECD3X1009 9S-XF1)	
10	X86361	格栅	X86361-G02	X86361-G02-03	1264	16	件	香槟金 (ECD3X1009 9S-XF1)	
11	X86361	格栅	X86361-G02	X86361-G02-04	1289	32	件	香槟金 (ECD3X1009 9S-XF1)	
12	X86361	格栅	X86361-G02	X86361-G02-05	1614	16	件	香槟金 (ECD3X1009 9S-XF1)	
13	X86361	格栅	X86361-G02	X86361-G02-06	1489	16	件	香槟金 (ECD3X1009 9S-XF1)	
14	X86361	格栅	X86361-G03	X86361-G03-01	1339	32	件	香槟金 (ECD3X1009 9S-XF1)	
15	X86361	格栅	X86361-G04	X86361-G04-01	1539.5	16	件	香槟金 (ECD3X1009 9S-XF1)	
16	X86361	格栅	X86361-G05	X86361-G05-01	727	32	件	香槟金 (ECD3X1009 9S-XF1)	
17	X86361	格栅	X86361-G06	X86361-G06-01	629.5	16	件	香槟金 (ECD3X1009 9S-XF1)	
18	X86361	格栅	X86361-G06	X86361-G06-02	1566	32	件	香槟金 (ECD3X1009 9S-XF1)	
19	X86361	格栅	X86361-G07	X86361-G07-01	634.5	16	件	香槟金 (ECD3X1009 9S-XF1)	
20	X86361	格栅	X86361-G08	X86361-G08-01	1484.5	16	件	香槟金 (ECD3X1009 9S-XF1)	
21	X86362	格栅扣盖	X86362-G01	X86362-G01-01	1574	32	件	香槟金 (ECD3X1009 9S-XF1)	
22	X86362	格栅扣盖	X86362-G01	X86362-G01-02	1564	32	件	香槟金 (ECD3X1009 9S-XF1)	
23	X86362	格栅扣盖	X86362-G01	X86362-G01-03	1264	32	件	香槟金 (ECD3X1009 9S-XF1)	
24	X86362	格栅扣盖	X86362-G01	X86362-G01-04	1289	64	件	香槟金 (ECD3X1009 9S-XF1)	
25	X86362	格栅扣盖	X86362-G01	X86362-G01-05	1614	32	件	香槟金 (ECD3X1009 9S-XF1)	
26	X86362	格栅扣盖	X86362-G01	X86362-G01-06	1489	32	件	香槟金 (ECD3X1009 9S-XF1)	
27	X86362	格栅扣盖	X86362-G01	X86362-G01-07	1341.5	32	件	香槟金 (ECD3X1009 9S-XF1)	
28	X86362	格栅扣盖	X86362-G01	X86362-G01-08	1339	32	件	香槟金 (ECD3X1009 9S-XF1)	
29	X86362	格栅扣盖	X86362-G02	X86362-G02-01	1520.5	16	件	香槟金 (ECD3X1009 9S-XF1)	
30	X86362	格栅扣盖	X86362-G02	X86362-G02-02	708	32	件	香槟金 (ECD3X1009 9S-XF1)	
31	X86362	格栅扣盖	X86362-G03	X86362-G03-01	610.5	16	件	香槟金 (ECD3X1009 9S-XF1)	
32	X86362	格栅扣盖	X86362-G03	X86362-G03-02	1547	32	件	香槟金 (ECD3X1009 9S-XF1)	
33	X86362	格栅扣盖	X86362-G04	X86362-G04-01	543.8	16	件	香槟金 (ECD3X1009 9S-XF1)	
34	X86362	格栅扣盖	X86362-G05	X86362-G05-01	1393.8	16	件	香槟金 (ECD3X1009 9S-XF1)	
35									
36									
37									
38									
39									
40									
41									
42									
43									
44									
45									
46									
47									
48									
49									
50									
51									
52									
53									
54									
55									
56									
57									
58									
59									

以下空白

说明: 1:注意保护成品, 严禁刻痕、划伤;

设计: 校对: 审核:



B.D. REF :

CLIENT : **信和置業有限公司**  
Sino Land Company Limited

ARCHITECT : **ronald lu & partners**  
**Ronald Lu & Partners (HK) Ltd.**  
呂宗祥建築師事務所 (香港) 有限公司

MAIN CONTRACTOR : **Gammon**

STRUCTURAL ENGINEER : **A=COM**

FAÇADE CONSULTANT : **A=COM**

NOTE :

1. ALL DIMENSIONS ARE IN mm.
2. ALL ELEVATIONS ARE VIEWED FROM OUTSIDE.
3. ALL DIMENSIONS TO BE VERIFIED ON SITE BEFORE FABRICATION.

LEGEND :

① RETAIL MARK NO.  
② REFER SHEET NO.

1. FFL --- FINISHED FLOOR LEVEL
2. STL --- STRUCTURAL FLOOR LEVEL
3. Ⓞ --- REVERSED DETAIL

NO.	DATE	REVISION	BY
JOB NO. : J-858			
PROJECT : PROPOSED RESIDENTIAL DEVELOPMENT AT TKOIL 70RP, PHASE 11, LOHAS PARK TSEUNG KWAN O, N.T.			
TITLE : ALUM. A.C. GRILLE AT ROOF FLOOR PART PLAN/ELEVATION/SECTION FOR TOWER 1A-FLAT F MARKING DRAWING			
DATE : 01-NOV-23		SCALE : 1:20	CHECKED BY :
DRAWN BY :		MIDI ALUMINUM FABRICATOR LTD.	
115, 117, 119, 121, 123, 125, 127, 129, 131, 133, 135, 137, 139, 141, 143, 145, 147, 149, 151, 153, 155, 157, 159, 161, 163, 165, 167, 169, 171, 173, 175, 177, 179, 181, 183, 185, 187, 189, 191, 193, 195, 197, 199, 201, 203, 205, 207, 209, 211, 213, 215, 217, 219, 221, 223, 225, 227, 229, 231, 233, 235, 237, 239, 241, 243, 245, 247, 249, 251, 253, 255, 257, 259, 261, 263, 265, 267, 269, 271, 273, 275, 277, 279, 281, 283, 285, 287, 289, 291, 293, 295, 297, 299, 301, 303, 305, 307, 309, 311, 313, 315, 317, 319, 321, 323, 325, 327, 329, 331, 333, 335, 337, 339, 341, 343, 345, 347, 349, 351, 353, 355, 357, 359, 361, 363, 365, 367, 369, 371, 373, 375, 377, 379, 381, 383, 385, 387, 389, 391, 393, 395, 397, 399, 401, 403, 405, 407, 409, 411, 413, 415, 417, 419, 421, 423, 425, 427, 429, 431, 433, 435, 437, 439, 441, 443, 445, 447, 449, 451, 453, 455, 457, 459, 461, 463, 465, 467, 469, 471, 473, 475, 477, 479, 481, 483, 485, 487, 489, 491, 493, 495, 497, 499, 501, 503, 505, 507, 509, 511, 513, 515, 517, 519, 521, 523, 525, 527, 529, 531, 533, 535, 537, 539, 541, 543, 545, 547, 549, 551, 553, 555, 557, 559, 561, 563, 565, 567, 569, 571, 573, 575, 577, 579, 581, 583, 585, 587, 589, 591, 593, 595, 597, 599, 601, 603, 605, 607, 609, 611, 613, 615, 617, 619, 621, 623, 625, 627, 629, 631, 633, 635, 637, 639, 641, 643, 645, 647, 649, 651, 653, 655, 657, 659, 661, 663, 665, 667, 669, 671, 673, 675, 677, 679, 681, 683, 685, 687, 689, 691, 693, 695, 697, 699, 701, 703, 705, 707, 709, 711, 713, 715, 717, 719, 721, 723, 725, 727, 729, 731, 733, 735, 737, 739, 741, 743, 745, 747, 749, 751, 753, 755, 757, 759, 761, 763, 765, 767, 769, 771, 773, 775, 777, 779, 781, 783, 785, 787, 789, 791, 793, 795, 797, 799, 801, 803, 805, 807, 809, 811, 813, 815, 817, 819, 821, 823, 825, 827, 829, 831, 833, 835, 837, 839, 841, 843, 845, 847, 849, 851, 853, 855, 857, 859, 861, 863, 865, 867, 869, 871, 873, 875, 877, 879, 881, 883, 885, 887, 889, 891, 893, 895, 897, 899, 901, 903, 905, 907, 909, 911, 913, 915, 917, 919, 921, 923, 925, 927, 929, 931, 933, 935, 937, 939, 941, 943, 945, 947, 949, 951, 953, 955, 957, 959, 961, 963, 965, 967, 969, 971, 973, 975, 977, 979, 981, 983, 985, 987, 989, 991, 993, 995, 997, 999, 1001, 1003, 1005, 1007, 1009, 1011, 1013, 1015, 1017, 1019, 1021, 1023, 1025, 1027, 1029, 1031, 1033, 1035, 1037, 1039, 1041, 1043, 1045, 1047, 1049, 1051, 1053, 1055, 1057, 1059, 1061, 1063, 1065, 1067, 1069, 1071, 1073, 1075, 1077, 1079, 1081, 1083, 1085, 1087, 1089, 1091, 1093, 1095, 1097, 1099, 1101, 1103, 1105, 1107, 1109, 1111, 1113, 1115, 1117, 1119, 1121, 1123, 1125, 1127, 1129, 1131, 1133, 1135, 1137, 1139, 1141, 1143, 1145, 1147, 1149, 1151, 1153, 1155, 1157, 1159, 1161, 1163, 1165, 1167, 1169, 1171, 1173, 1175, 1177, 1179, 1181, 1183, 1185, 1187, 1189, 1191, 1193, 1195, 1197, 1199, 1201, 1203, 1205, 1207, 1209, 1211, 1213, 1215, 1217, 1219, 1221, 1223, 1225, 1227, 1229, 1231, 1233, 1235, 1237, 1239, 1241, 1243, 1245, 1247, 1249, 1251, 1253, 1255, 1257, 1259, 1261, 1263, 1265, 1267, 1269, 1271, 1273, 1275, 1277, 1279, 1281, 1283, 1285, 1287, 1289, 1291, 1293, 1295, 1297, 1299, 1301, 1303, 1305, 1307, 1309, 1311, 1313, 1315, 1317, 1319, 1321, 1323, 1325, 1327, 1329, 1331, 1333, 1335, 1337, 1339, 1341, 1343, 1345, 1347, 1349, 1351, 1353, 1355, 1357, 1359, 1361, 1363, 1365, 1367, 1369, 1371, 1373, 1375, 1377, 1379, 1381, 1383, 1385, 1387, 1389, 1391, 1393, 1395, 1397, 1399, 1401, 1403, 1405, 1407, 1409, 1411, 1413, 1415, 1417, 1419, 1421, 1423, 1425, 1427, 1429, 1431, 1433, 1435, 1437, 1439, 1441, 1443, 1445, 1447, 1449, 1451, 1453, 1455, 1457, 1459, 1461, 1463, 1465, 1467, 1469, 1471, 1473, 1475, 1477, 1479, 1481, 1483, 1485, 1487, 1489, 1491, 1493, 1495, 1497, 1499, 1501, 1503, 1505, 1507, 1509, 1511, 1513, 1515, 1517, 1519, 1521, 1523, 1525, 1527, 1529, 1531, 1533, 1535, 1537, 1539, 1541, 1543, 1545, 1547, 1549, 1551, 1553, 1555, 1557, 1559, 1561, 1563, 1565, 1567, 1569, 1571, 1573, 1575, 1577, 1579, 1581, 1583, 1585, 1587, 1589, 1591, 1593, 1595, 1597, 1599, 1601, 1603, 1605, 1607, 1609, 1611, 1613, 1615, 1617, 1619, 1621, 1623, 1625, 1627, 1629, 1631, 1633, 1635, 1637, 1639, 1641, 1643, 1645, 1647, 1649, 1651, 1653, 1655, 1657, 1659, 1661, 1663, 1665, 1667, 1669, 1671, 1673, 1675, 1677, 1679, 1681, 1683, 1685, 1687, 1689, 1691, 1693, 1695, 1697, 1699, 1701, 1703, 1705, 1707, 1709, 1711, 1713, 1715, 1717, 1719, 1721, 1723, 1725, 1727, 1729, 1731, 1733, 1735, 1737, 1739, 1741, 1743, 1745, 1747, 1749, 1751, 1753, 1755, 1757, 1759, 1761, 1763, 1765, 1767, 1769, 1771, 1773, 1775, 1777, 1779, 1781, 1783, 1785, 1787, 1789, 1791, 1793, 1795, 1797, 1799, 1801, 1803, 1805, 1807, 1809, 1811, 1813, 1815, 1817, 1819, 1821, 1823, 1825, 1827, 1829, 1831, 1833, 1835, 1837, 1839, 1841, 1843, 1845, 1847, 1849, 1851, 1853, 1855, 1857, 1859, 1861, 1863, 1865, 1867, 1869, 1871, 1873, 1875, 1877, 1879, 1881, 1883, 1885, 1887, 1889, 1891, 1893, 1895, 1897, 1899, 1901, 1903, 1905, 1907, 1909, 1911, 1913, 1915, 1917, 1919, 1921, 1923, 1925, 1927, 1929, 1931, 1933, 1935, 1937, 1939, 1941, 1943, 1945, 1947, 1949, 1951, 1953, 1955, 1957, 1959, 1961, 1963, 1965, 1967, 1969, 1971, 1973, 1975, 1977, 1979, 1981, 1983, 1985, 1987, 1989, 1991, 1993, 1995, 1997, 1999, 2001, 2003, 2005, 2007, 2009, 2011, 2013, 2015, 2017, 2019, 2021, 2023, 2025, 2027, 2029, 2031, 2033, 2035, 2037, 2039, 2041, 2043, 2045, 2047, 2049, 2051, 2053, 2055, 2057, 2059, 2061, 2063, 2065, 2067, 2069, 2071, 2073, 2075, 2077, 2079, 2081, 2083, 2085, 2087, 2089, 2091, 2093, 2095, 2097, 2099, 2101, 2103, 2105, 2107, 2109, 2111, 2113, 2115, 2117, 2119, 2121, 2123, 2125, 2127, 2129, 2131, 2133, 2135, 2137, 2139, 2141, 2143, 2145, 2147, 2149, 2151, 2153, 2155, 2157, 2159, 2161, 2163, 2165, 2167, 2169, 2171, 2173, 2175, 2177, 2179, 2181, 2183, 2185, 2187, 2189, 2191, 2193, 2195, 2197, 2199, 2201, 2203, 2205, 2207, 2209, 2211, 2213, 2215, 2217, 2219, 2221, 2223, 2225, 2227, 2229, 2231, 2233, 2235, 2237, 2239, 2241, 2243, 2245, 2247, 2249, 2251, 2253, 2255, 2257, 2259, 2261, 2263, 2265, 2267, 2269, 2271, 2273, 2275, 2277, 2279, 2281, 2283, 2285, 2287, 2289, 2291, 2293, 2295, 2297, 2299, 2301, 2303, 2305, 2307, 2309, 2311, 2313, 2315, 2317, 2319, 2321, 2323, 2325, 2327, 2329, 2331, 2333, 2335, 2337, 2339, 2341, 2343, 2345, 2347, 2349, 2351, 2353, 2355, 2357, 2359, 2361, 2363, 2365, 2367, 2369, 2371, 2373, 2375, 2377, 2379, 2381, 2383, 2385, 2387, 2389, 2391, 2393, 2395, 2397, 2399, 2401, 2403, 2405, 2407, 2409, 2411, 2413, 2415, 2417, 2419, 2421, 2423, 2425, 2427, 2429, 2431, 2433, 2435, 2437, 2439, 2441, 2443, 2445, 2447, 2449, 2451, 2453, 2455, 2457, 2459, 2461, 2463, 2465, 2467, 2469, 2471, 2473, 2475, 2477, 2479, 2481, 2483, 2485, 2487, 2489, 2491, 2493, 2495, 2497, 2499, 2501, 2503, 2505, 2507, 2509, 2511, 2513, 2515, 2517, 2519, 2521, 2523, 2525, 2527, 2529, 2531, 2533, 2535, 2537, 2539, 2541, 2543, 2545, 2547, 2549, 2551, 2553, 2555, 2557, 2559, 2561, 2563, 2565, 2567, 2569, 2571, 2573, 2575, 2577, 2579, 2581, 2583, 2585, 2587, 2589, 2591, 2593, 2595, 2597, 2599, 2601, 2603, 2605, 2607, 2609, 2611, 2613, 2615, 2617, 2619, 2621, 2623, 2625, 2627, 2629, 2631, 2633, 2635, 2637, 2639, 2641, 2643, 2645, 2647, 2649, 2651, 2653, 2655, 2657, 2659, 2661, 2663, 2665, 2667, 2669, 2671, 2673, 2675, 2677, 2679, 2681, 2683, 2685, 2687, 2689, 2691, 2693, 2695, 2697, 2699, 2701, 2703, 2705, 2707, 2709, 2711, 2713, 2715, 2717, 2719, 2721, 2723, 2725, 2727, 2729, 2731, 2733, 2735, 2737, 2739, 2741, 2743, 2745, 2747, 2749, 2751, 2753, 2755, 2757, 2759, 2761, 2763, 2765, 2767, 2769, 2771, 2773, 2775, 2777, 2779, 2781, 2783, 2785, 2787, 2789, 2791, 2793, 2795, 2797, 2799, 2801, 2803, 2805, 2807, 2809, 2811, 2813, 2815, 2817, 2819, 2821, 2823, 2825, 2827, 2829, 2831, 2833, 2835, 2837, 2839, 2841, 2843, 2845, 2847, 2849, 2851, 2853, 2855, 2857, 2859, 2861, 2863, 2865, 2867, 2869, 2871, 2873, 2875, 2877, 2879, 2881, 2883, 2885, 2887, 2889, 2891, 2893, 2895, 2897, 2899, 2901, 2903, 2905, 2907, 2909, 2911, 2913, 2915, 2917, 2919, 2921, 2923, 2925, 2927, 2929, 2931, 2933, 2935, 2937, 2939, 2941, 2943, 2945, 2947, 2949, 2951, 2953, 2955, 2957, 2959, 2961, 2963, 2965, 2967, 2969, 2971, 2973, 2975, 2977, 2979, 2981, 2983, 2985, 2987, 2989, 2991, 2993, 2995, 2997, 2999, 3001, 3003, 3005, 3007, 3009, 3011, 3013, 3015, 3017, 3019, 3021, 3023, 3025, 3027, 3029, 3031, 3033, 3035, 3037, 3039, 3041, 3043, 3045, 3047, 3049, 3051, 3053, 3055, 3057, 3059, 3061, 3063, 3065, 3067, 3069, 3071, 3073, 3075, 3077, 3079, 3081, 3083, 3085, 3087, 3089, 3091, 3093, 3095, 3097, 3099, 3101, 3103, 3105, 3107, 3109, 3111, 3113, 3115, 3117, 3119, 3121, 3123, 3125, 3127, 3129, 3131, 3133, 3135, 3137, 3139, 3141, 3143, 3145, 3147, 3149, 3151, 3153, 3155, 3157, 3159, 3161, 3163, 3165, 3167, 3169, 3171, 3173, 3175, 3177, 3179, 3181, 3183, 3185, 3187, 3189, 3191, 3193, 3195, 3197, 3199, 3201, 3203, 3205, 3207, 3209, 3211, 3213, 3215, 3217, 3219, 3221, 3223, 3225, 3227, 3229, 3231, 3233, 3235, 3237, 3239, 3241, 3243, 3245, 3247, 3249, 3251, 3253, 3255, 3257, 3259, 3261, 3263, 3265, 3267, 3269, 3271, 3273, 3275, 3277, 3279, 3281, 3283, 3285, 3287, 3289, 3291, 3293, 3295, 3297, 3299, 3301, 3303, 3305, 3307, 3309, 3311, 3313, 3315, 3317, 3319, 3321, 3323, 3325, 3327, 3329, 3331, 3333, 3335, 3337, 3339, 3341, 3343, 3345, 3347, 3349, 3351, 3353, 3355, 3357, 3359, 3361, 3363, 3365, 3367, 3369, 3371, 3373, 3375, 3377, 3379, 3381, 3383, 3385, 3387, 3389, 3391, 3393, 3395, 3397, 3399, 3401, 3403, 3405, 3407, 3409, 3411, 3413, 3415, 3417, 3419, 3421, 3423, 3425, 3427, 3429, 3431, 3433, 3435, 3437, 3439, 3441, 3443, 3445, 3447, 3449, 3451, 3453, 3455, 3457, 3459, 3461, 3463, 3465, 3467, 3469, 3471, 3473, 3475, 3477, 3479, 3481, 3483, 3485, 3487, 3489, 3491, 3493, 3495, 3497, 3499, 3501, 3503, 3505, 3507, 3509, 3511, 3513, 3515, 3517, 3519, 3521, 3523, 3525, 3527, 3529, 3531, 3533, 3535, 3537, 3539, 3541, 3543, 3545, 3547, 3549, 3551, 3553, 3555, 3557, 3559, 3561, 3563, 3565, 3567, 3569, 3571, 3573, 3575, 3577, 3579, 3581, 3583, 3585, 3587, 3589, 3591, 3593, 3595, 3597, 3599, 3601, 3603, 3605, 3607, 3609, 3611, 3613, 3615, 3617, 3619, 3621, 3623, 3625, 3627, 3629, 3631, 3633, 3635, 3637, 3639, 3641, 3643, 3645, 3647, 3649, 3651, 3653, 3655, 3657, 3659, 3661, 3663, 3665, 3667, 3669, 3671, 3673, 3675, 3677, 3679, 3681, 3683, 3685, 3687, 3689, 3691, 3693, 3695, 3697, 3699, 3701, 3703, 3705, 3707, 3709, 3711, 3713, 3715, 3717, 3719, 3721, 3723, 3725, 3727, 3729, 3731, 3733, 3735, 3737, 3739, 3741, 3743, 3745, 3747, 3749, 3751, 3753, 3755, 3757, 3759, 3761, 3763, 3765, 3767, 3769, 3771, 3773, 3775, 3777, 3779, 3781, 3783, 3785, 3787, 3789, 3791, 3793, 3795, 3797, 3799, 3801, 3803, 3805, 3807, 3809, 3811, 3813, 3815, 3817, 3819, 3821, 3823, 3825, 3827, 3829, 3831, 3833, 3835, 3837, 3839, 3841, 3843, 3845, 3847, 3849, 3851, 3853, 3855, 3857, 3859, 3861, 3863, 3865, 3867, 3869, 3871, 3873, 3875, 3877, 3879, 3881, 3883, 3885, 3887, 3889, 3891, 3893, 3895, 3897, 3899, 3901, 3903, 3905, 3907, 3909, 3911, 3913, 3915, 3917, 3919, 3921, 3923, 3925, 3927, 3929, 3931, 3933, 3935, 3937, 3939, 3941, 3943, 3945, 3947, 3949, 3951, 3953, 3955, 3957, 3959, 3961, 3963, 3965, 3967, 3969, 3971, 3973, 3975, 3977, 3979, 3981, 3983, 3985, 3987, 3989, 3991, 3993, 3995, 3997, 3999, 4001, 4003, 4005, 4007, 4009, 4011, 4013, 4015, 4017, 4019, 4021, 4023, 4025, 4027, 4029, 4031, 4033, 4035, 4037, 4039, 4041, 4043, 4045, 4047, 4049, 4051, 4053, 4055, 4057, 4059, 4061, 4063, 4065, 4067, 4069, 4071, 4073, 4075, 4077, 4079, 4081, 4083, 4085, 4087, 4089, 4091, 4093, 4095, 4097, 4099, 4101, 4103, 4105, 4107, 4109, 4111, 4113, 4115, 4117, 4119, 4121, 4123, 4125, 4127, 4129, 4131, 4133, 4135, 4137, 4139, 4141, 4143, 4145, 4147, 4149, 4151, 4153, 4155, 4157, 4159, 416			









B.O. REF :

CLIENT : 信和置業有限公司  
Sino Land Company Limited

ARCHITECT : Ronald Lu & Partners  
Ronald Lu & Partners (HK) Ltd.  
呂元祥建築師事務所 (香港) 有限公司

MAIN CONTRACTOR : Gammon

STRUCTURAL ENGINEER : AECOM

FAÇADE CONSULTANT: AECOM

NOTE :

1. ALL DIMENSIONS ARE IN MM.
2. ALL ELEVATIONS ARE VIEWED FROM OUTSIDE.
3. ALL DIMENSIONS TO BE VERIFIED ON SITE BEFORE FABRICATION.

LEGEND :

① --- DETAIL MARK NO.  
② --- REFER SHEET NO.

1. F.F.L --- FINISHED FLOOR LEVEL  
2. S.F.L --- STRUCTURAL FLOOR LEVEL  
3. Ⓞ --- REVERSED DETAIL

JOB NO. :	J-858
PROJECT :	PROPOSED RESIDENTIAL DEVELOPMENT AT TKOTL 70RP, PHASE 11, LOMAS PARK TSEUNG KWAN O, N.T.
TITLE :	ALUM. A.C. GRILLE AT ROOF FLOOR PART PLAN/ELEVATION/SECTION FOR TOWER 2B-FLAT A MARKING DRAWING
DATE :	01-NOV-23
SCALE :	1:20
DRAWN BY :	CHECKED BY :
MIDI ALUMINIUM FABRICATOR LTD. Unit: B-4, Sunny Industrial Centre, 1/F 1622-1623, 1624-1625, 1626, 1627, 1628, 1629, 1630, 1631, 1632, 1633, 1634, 1635, 1636, 1637, 1638, 1639, 1640, 1641, 1642, 1643, 1644, 1645, 1646, 1647, 1648, 1649, 1650, 1651, 1652, 1653, 1654, 1655, 1656, 1657, 1658, 1659, 1660, 1661, 1662, 1663, 1664, 1665, 1666, 1667, 1668, 1669, 1670, 1671, 1672, 1673, 1674, 1675, 1676, 1677, 1678, 1679, 1680, 1681, 1682, 1683, 1684, 1685, 1686, 1687, 1688, 1689, 1690, 1691, 1692, 1693, 1694, 1695, 1696, 1697, 1698, 1699, 1700 Tel: (852) 27771666 Fax: (852) 27771666	
DWG NO. :	J858-ACC-MK2303
REV. :	-

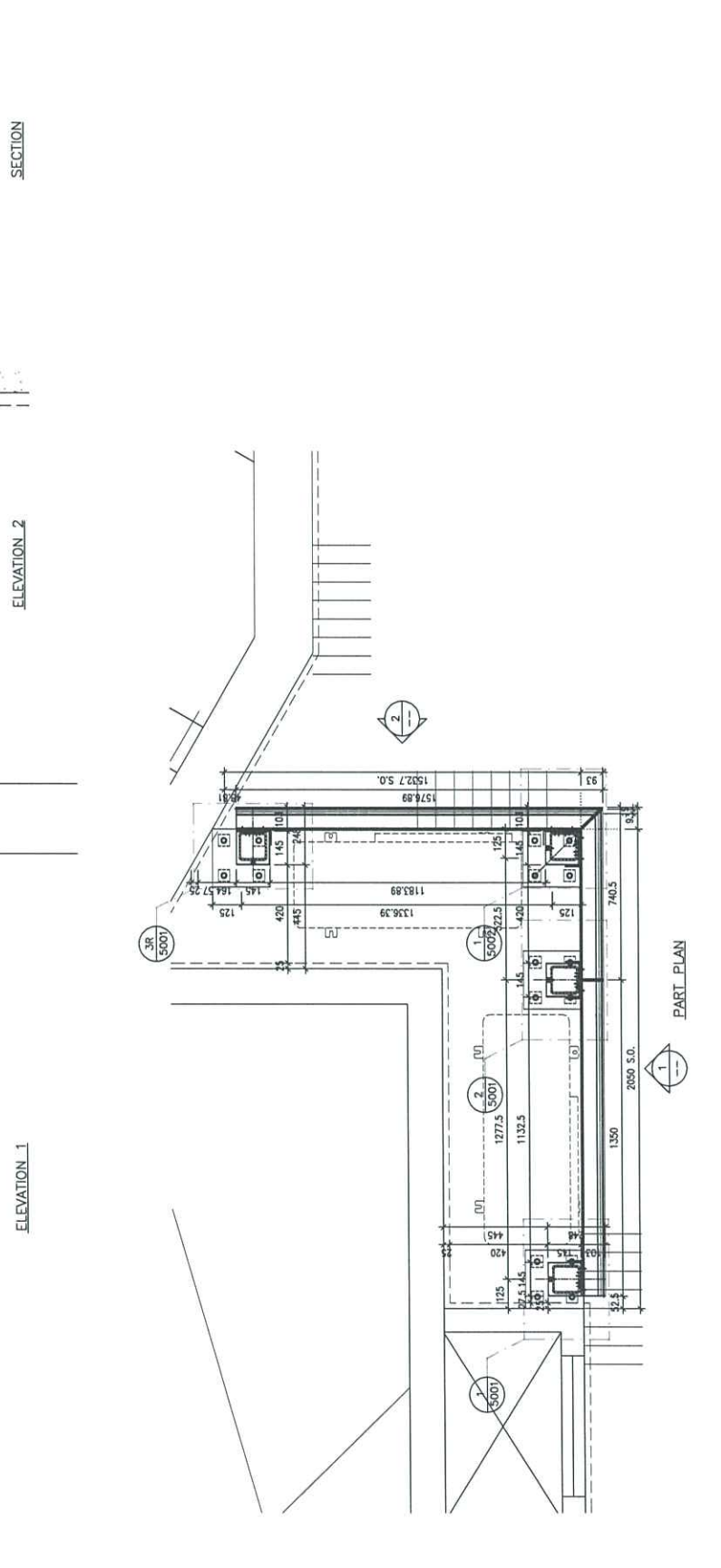
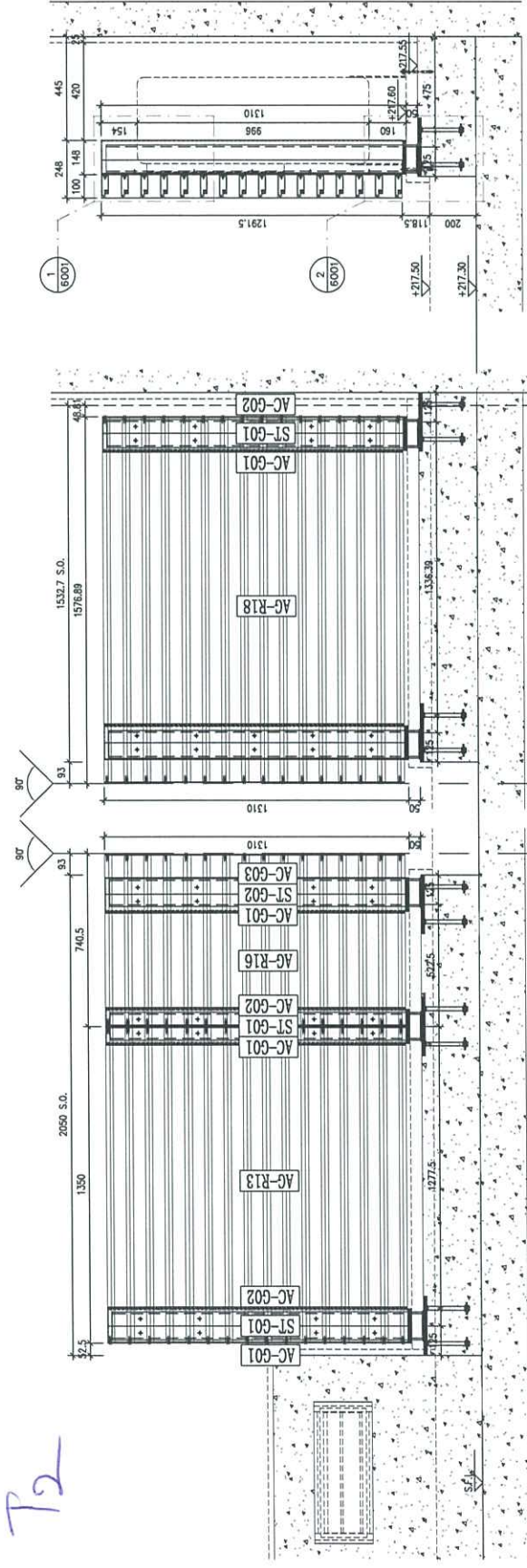





B.D. REF :

CLIENT : 信和置業有限公司  
Sino Land Company Limited

ARCHITECT : Ronald Lu & Partners  
Ronald Lu & Partners (HK) Ltd.  
呂宗祥建築師事務所 (香港) 有限公司

MAIN CONTRACTOR : Gammon

STRUCTURAL ENGINEER : AECOM

GRADE CONSULTANT: AECOM

NOTE :

1. ALL DIMENSIONS ARE IN mm.
2. ALL ELEVATIONS ARE VIEWED FROM OUTSIDE.
3. ALL DIMENSIONS TO BE VERIFIED ON SITE BEFORE FABRICATION.

LEGEND :

DETAIL MARK NO.

REFER SHEET NO.

1. F.F.L. — FINISHED FLOOR LEVEL.
2. S.F.L. — STRUCTURAL FLOOR LEVEL.
3. — REVISED DETAIL.

JOB NO. :	J-858
PROJECT :	RESIDENTIAL DEVELOPMENT AT TKOTL 70RP, PHASE 11, LOHAS PARK TSEUNG KWAN O, N.T.
TITLE :	ALUM. A.C. GRILLE AT ROOF FLOOR PART PLAN/ELEVATION/SECTION FOR TOWER 3A-FLAT F MARKING DRAWING
DATE :	01-NOV-23
SCALE :	1:20
DRAWN BY :	CHECKED BY :
MIDI ALUMINIUM FABRICATOR LTD. MIDI Aluminium Fabricator Ltd. 610 Cheung Kwan Road, Kwun Tong, Kowloon Tel: 23488211-4 Fax: (852) 27771656	
DWG NO. :	J858-ACC-WK2302
REV. :	-

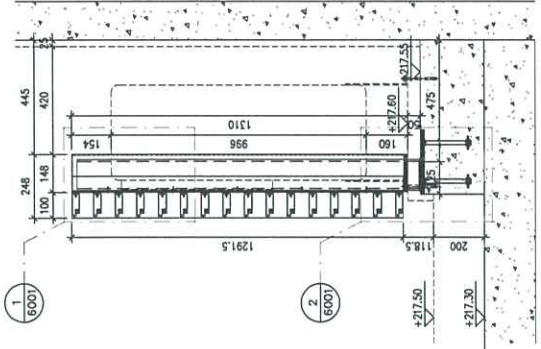

SECTION

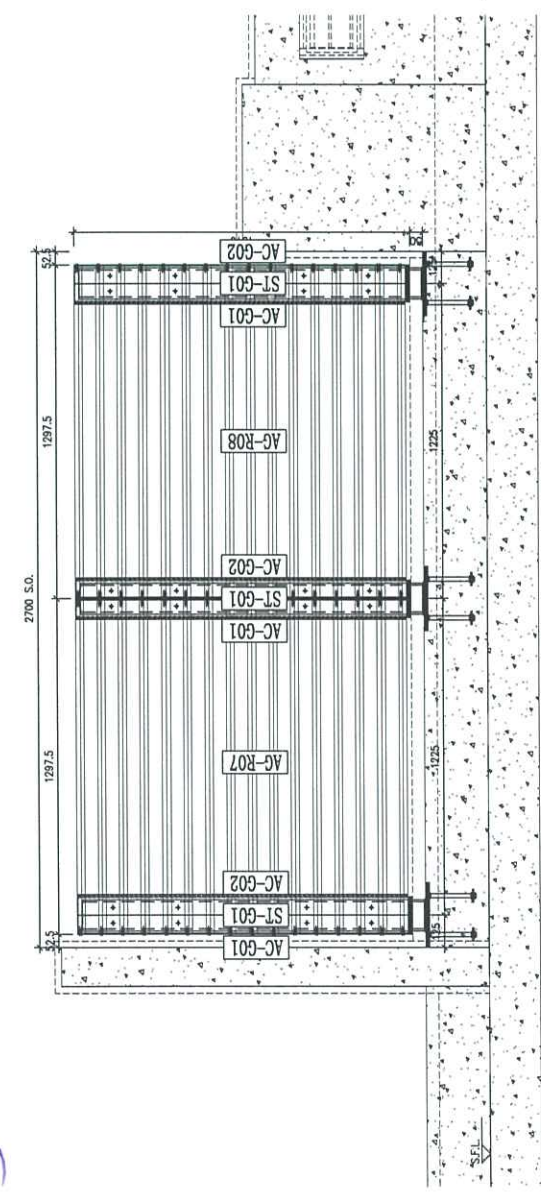

ELEVATION

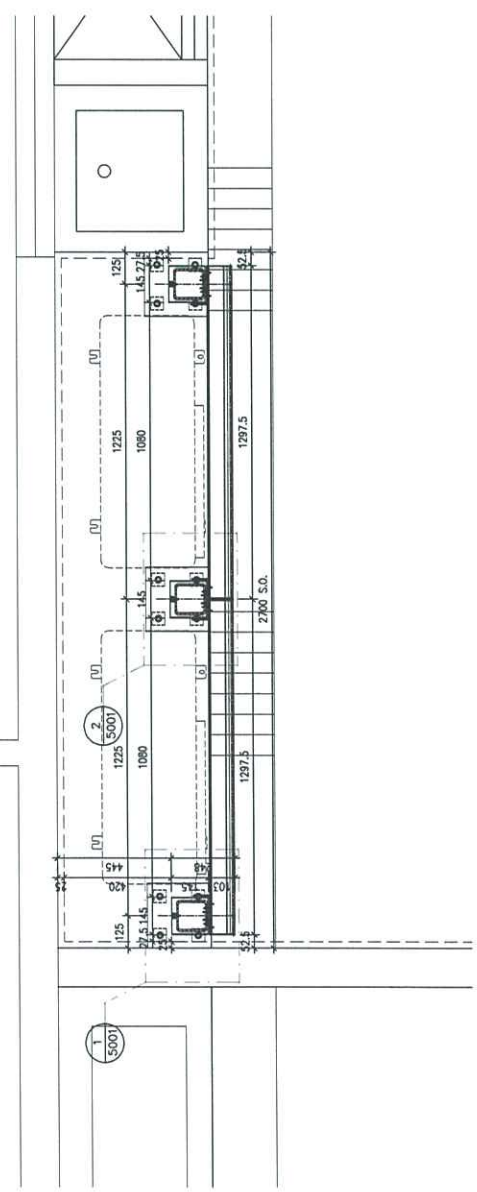

PART PLAN

73



S.D. REF :

CLIENT :



Sino Land Company Limited

ARCHITECT :



ronald lu & partners  
Ronald Lu & Partners (HK) Ltd.  
呂文輝建築師事務所 (香港) 有限公司

MAIN CONTRACTOR :



Gammon

STRUCTURAL ENGINEER :



AECOM

FACE CONSULTANT:



AECOM

NOTE:

- 1. ALL DIMENSIONS ARE IN mm.
- 2. ALL ELEVATIONS ARE VIEWED FROM OUTSIDE.
- 3. ALL DIMENSIONS TO BE VERIFIED ON SITE BEFORE FABRICATION.

LEGEND:

- ① DETAIL MARK NO.
- ② REFER SHEET NO.
- 1. F.F.L. --- FINISHED FLOOR LEVEL
- 2. S.F.L. --- STRUCTURAL FLOOR LEVEL
- 3. ⓧ --- REVERSED DETAIL

DATE :

01-NOV-23

SCALE :

1:20

DRAWN BY :

J-858

CHECKED BY :

J-858

PROJECT :

PROPOSED RESIDENTIAL DEVELOPMENT  
AT TKOYL 70RP, PHASE 11, LOHAS PARK  
TSEUNG KWAN O, N.T.

TITLE :

ALUM. A.C. GRILLE AT ROOF FLOOR  
PART PLAN/ELEVATION/SECTION  
FOR TOWER 3B--FLAT B  
MARKING DRAWING

DATE :

01-NOV-23

SCALE :

1:20

DRAWN BY :

J-858

CHECKED BY :

J-858

PROJECT :

PROPOSED RESIDENTIAL DEVELOPMENT  
AT TKOYL 70RP, PHASE 11, LOHAS PARK  
TSEUNG KWAN O, N.T.

TITLE :

ALUM. A.C. GRILLE AT ROOF FLOOR  
PART PLAN/ELEVATION/SECTION  
FOR TOWER 3B--FLAT B  
MARKING DRAWING

DATE :

01-NOV-23

SCALE :

1:20

DRAWN BY :

J-858

CHECKED BY :

J-858

PROJECT :

PROPOSED RESIDENTIAL DEVELOPMENT  
AT TKOYL 70RP, PHASE 11, LOHAS PARK  
TSEUNG KWAN O, N.T.

TITLE :

ALUM. A.C. GRILLE AT ROOF FLOOR  
PART PLAN/ELEVATION/SECTION  
FOR TOWER 3B--FLAT B  
MARKING DRAWING

DATE :

01-NOV-23

SCALE :

1:20

DRAWN BY :

J-858

CHECKED BY :

J-858

PROJECT :

PROPOSED RESIDENTIAL DEVELOPMENT  
AT TKOYL 70RP, PHASE 11, LOHAS PARK  
TSEUNG KWAN O, N.T.

TITLE :

ALUM. A.C. GRILLE AT ROOF FLOOR  
PART PLAN/ELEVATION/SECTION  
FOR TOWER 3B--FLAT B  
MARKING DRAWING

DATE :

01-NOV-23

SCALE :

1:20

DRAWN BY :

J-858

CHECKED BY :

J-858

PROJECT :

PROPOSED RESIDENTIAL DEVELOPMENT  
AT TKOYL 70RP, PHASE 11, LOHAS PARK  
TSEUNG KWAN O, N.T.

TITLE :

ALUM. A.C. GRILLE AT ROOF FLOOR  
PART PLAN/ELEVATION/SECTION  
FOR TOWER 3B--FLAT B  
MARKING DRAWING

DATE :

01-NOV-23

SCALE :

1:20

DRAWN BY :

J-858

CHECKED BY :

J-858

PROJECT :

PROPOSED RESIDENTIAL DEVELOPMENT  
AT TKOYL 70RP, PHASE 11, LOHAS PARK  
TSEUNG KWAN O, N.T.

TITLE :

ALUM. A.C. GRILLE AT ROOF FLOOR  
PART PLAN/ELEVATION/SECTION  
FOR TOWER 3B--FLAT B  
MARKING DRAWING

DATE :

01-NOV-23

SCALE :

1:20

DRAWN BY :

J-858

CHECKED BY :

J-858

PROJECT :

PROPOSED RESIDENTIAL DEVELOPMENT  
AT TKOYL 70RP, PHASE 11, LOHAS PARK  
TSEUNG KWAN O, N.T.

TITLE :

ALUM. A.C. GRILLE AT ROOF FLOOR  
PART PLAN/ELEVATION/SECTION  
FOR TOWER 3B--FLAT B  
MARKING DRAWING

DATE :

01-NOV-23

SCALE :

1:20

DRAWN BY :

J-858

CHECKED BY :

J-858

PROJECT :

PROPOSED RESIDENTIAL DEVELOPMENT  
AT TKOYL 70RP, PHASE 11, LOHAS PARK  
TSEUNG KWAN O, N.T.

TITLE :

ALUM. A.C. GRILLE AT ROOF FLOOR  
PART PLAN/ELEVATION/SECTION  
FOR TOWER 3B--FLAT B  
MARKING DRAWING

DATE :

01-NOV-23

SCALE :

1:20

DRAWN BY :

J-858

CHECKED BY :

J-858

PROJECT :

PROPOSED RESIDENTIAL DEVELOPMENT  
AT TKOYL 70RP, PHASE 11, LOHAS PARK  
TSEUNG KWAN O, N.T.

TITLE :

ALUM. A.C. GRILLE AT ROOF FLOOR  
PART PLAN/ELEVATION/SECTION  
FOR TOWER 3B--FLAT B  
MARKING DRAWING

DATE :

01-NOV-23

SCALE :

1:20

DRAWN BY :

J-858

CHECKED BY :

J-858

PROJECT :

PROPOSED RESIDENTIAL DEVELOPMENT  
AT TKOYL 70RP, PHASE 11, LOHAS PARK  
TSEUNG KWAN O, N.T.

TITLE :

ALUM. A.C. GRILLE AT ROOF FLOOR  
PART PLAN/ELEVATION/SECTION  
FOR TOWER 3B--FLAT B  
MARKING DRAWING

DATE :

01-NOV-23

SCALE :

1:20

DRAWN BY :

J-858

CHECKED BY :

J-858

PROJECT :

PROPOSED RESIDENTIAL DEVELOPMENT  
AT TKOYL 70RP, PHASE 11, LOHAS PARK  
TSEUNG KWAN O, N.T.

TITLE :

ALUM. A.C. GRILLE AT ROOF FLOOR  
PART PLAN/ELEVATION/SECTION  
FOR TOWER 3B--FLAT B  
MARKING DRAWING

DATE :

01-NOV-23

SCALE :

1:20

DRAWN BY :

J-858

CHECKED BY :

J-858

PROJECT :

PROPOSED RESIDENTIAL DEVELOPMENT  
AT TKOYL 70RP, PHASE 11, LOHAS PARK  
TSEUNG KWAN O, N.T.

TITLE :

ALUM. A.C. GRILLE AT ROOF FLOOR  
PART PLAN/ELEVATION/SECTION  
FOR TOWER 3B--FLAT B  
MARKING DRAWING

DATE :

01-NOV-23

SCALE :

1:20

DRAWN BY :

J-858

CHECKED BY :

J-858

PROJECT :

PROPOSED RESIDENTIAL DEVELOPMENT  
AT TKOYL 70RP, PHASE 11, LOHAS PARK  
TSEUNG KWAN O, N.T.

TITLE :

ALUM. A.C. GRILLE AT ROOF FLOOR  
PART PLAN/ELEVATION/SECTION  
FOR TOWER 3B--FLAT B  
MARKING DRAWING

DATE :

01-NOV-23

SCALE :

1:20

DRAWN BY :

J-858

CHECKED BY :

J-858

PROJECT :

PROPOSED RESIDENTIAL DEVELOPMENT  
AT TKOYL 70RP, PHASE 11, LOHAS PARK  
TSEUNG KWAN O, N.T.

TITLE :

ALUM. A.C. GRILLE AT ROOF FLOOR  
PART PLAN/ELEVATION/SECTION  
FOR TOWER 3B--FLAT B  
MARKING DRAWING

DATE :

01-NOV-23

SCALE :

1:20

DRAWN BY :

J-858

CHECKED BY :

J-858

PROJECT :

PROPOSED RESIDENTIAL DEVELOPMENT  
AT TKOYL 70RP, PHASE 11, LOHAS PARK  
TSEUNG KWAN O, N.T.

TITLE :

ALUM. A.C. GRILLE AT ROOF FLOOR  
PART PLAN/ELEVATION/SECTION  
FOR TOWER 3B--FLAT B  
MARKING DRAWING

DATE :

01-NOV-23

SCALE :

1:20

DRAWN BY :

J-858

CHECKED BY :

J-858

PROJECT :

PROPOSED RESIDENTIAL DEVELOPMENT  
AT TKOYL 70RP, PHASE 11, LOHAS PARK  
TSEUNG KWAN O, N.T.

TITLE :

ALUM. A.C. GRILLE AT ROOF FLOOR  
PART PLAN/ELEVATION/SECTION  
FOR TOWER 3B--FLAT B  
MARKING DRAWING

DATE :

01-NOV-23

SCALE :

1:20

DRAWN BY :

J-858

CHECKED BY :

J-858

PROJECT :

PROPOSED RESIDENTIAL DEVELOPMENT  
AT TKOYL 70RP, PHASE 11, LOHAS PARK  
TSEUNG KWAN O, N.T.

TITLE :

ALUM. A.C. GRILLE AT ROOF FLOOR  
PART PLAN/ELEVATION/SECTION  
FOR TOWER 3B--FLAT B  
MARKING DRAWING

DATE :

01-NOV-23

SCALE :

1:20

DRAWN BY :

J-858

CHECKED BY :

J-858

PROJECT :

PROPOSED RESIDENTIAL DEVELOPMENT  
AT TKOYL 70RP, PHASE 11, LOHAS PARK  
TSEUNG KWAN O, N.T.

TITLE :

ALUM. A.C. GRILLE AT ROOF FLOOR  
PART PLAN/ELEVATION/SECTION  
FOR TOWER 3B--FLAT B  
MARKING DRAWING

DATE :

01-NOV-23

SCALE :

1:20

DRAWN BY :

J-858

CHECKED BY :

J-858

PROJECT :

PROPOSED RESIDENTIAL DEVELOPMENT  
AT TKOYL 70RP, PHASE 11, LOHAS PARK  
TSEUNG KWAN O, N.T.

TITLE :

ALUM. A.C. GRILLE AT ROOF FLOOR  
PART PLAN/ELEVATION/SECTION  
FOR TOWER 3B--FLAT B  
MARKING DRAWING

DATE :

01-NOV-23

SCALE :

1:20

DRAWN BY :

J-858

CHECKED BY :

J-858

PROJECT :

PROPOSED RESIDENTIAL DEVELOPMENT  
AT TKOYL 70RP, PHASE 11, LOHAS PARK  
TSEUNG KWAN O, N.T.

TITLE :

ALUM. A.C. GRILLE AT ROOF FLOOR  
PART PLAN/ELEVATION/SECTION  
FOR TOWER 3B--FLAT B  
MARKING DRAWING

DATE :

01-NOV-23

SCALE :

1:20

DRAWN BY :

J-858

CHECKED BY :

J-858

PROJECT :

PROPOSED RESIDENTIAL DEVELOPMENT  
AT TKOYL 70RP, PHASE 11, LOHAS PARK  
TSEUNG KWAN O, N.T.

TITLE :

ALUM. A.C. GRILLE AT ROOF FLOOR  
PART PLAN/ELEVATION/SECTION  
FOR TOWER 3B--FLAT B  
MARKING DRAWING

DATE :

01-NOV-23

SCALE :

1:20

DRAWN BY :

J-858

CHECKED BY :



美特鋁質有限公司  
MIDI Aluminium Fabricator Ltd.

工程號	J858	類別		物料號	-	
地盘	康城11期	制圖	K. C	2023-11-22	圖號	J858-AG-R01
图纸名称	格栅组装图	復核	-	-	數量	1
材料	-	批准	-	-	單件重量	- (KG)

修改日期

採用工廠  
地盤 ✓  
材料颜色 -

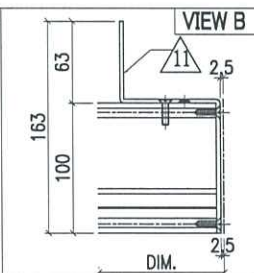
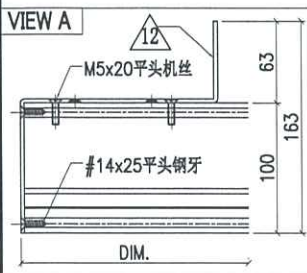
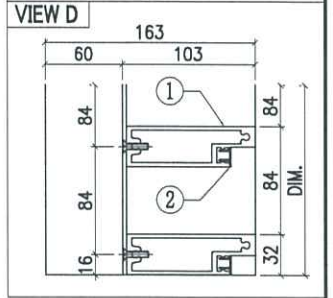
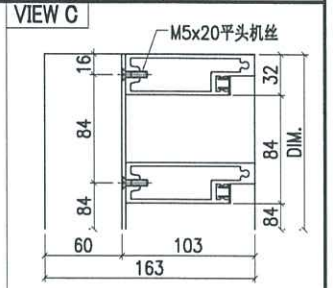
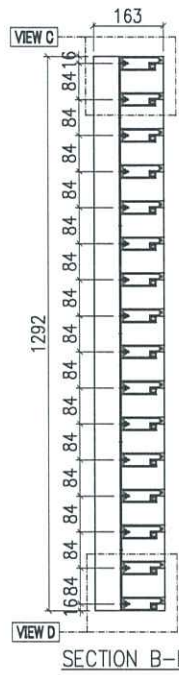
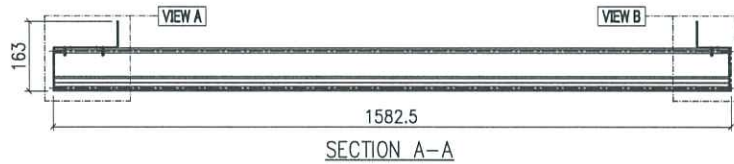
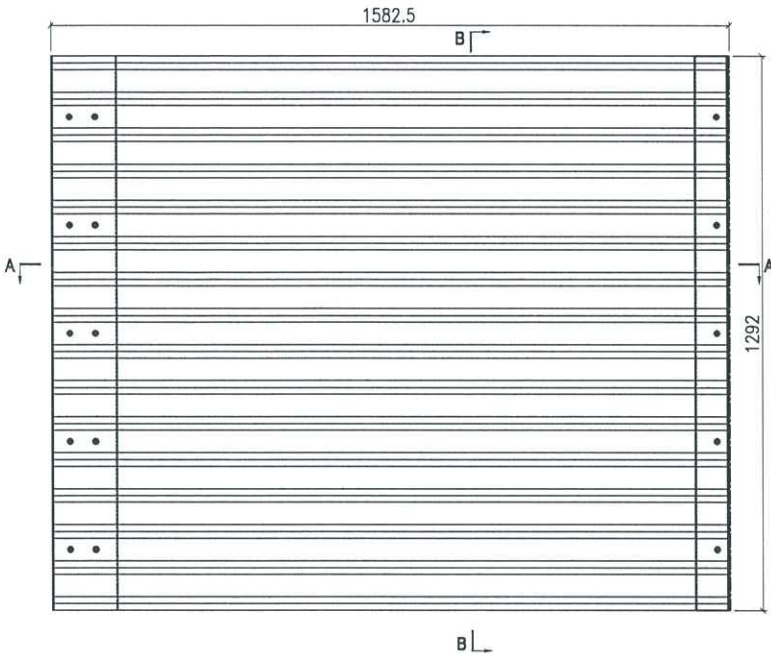

○ ALUM. EXTRUSION			
ITEM	FAB. DWG NO.	LENGTH (mm)	QTY
1	X86361-G01-01	1574	16
2	X86362-G01-01	1574	16

◇ OTHERS (ALUM. & G.M.S. PARTS)			
ITEM	FAB. DWG NO.	LENGTH (mm)	QTY
11	AC-G52	1292	1
	3mm ALUM. PLATE		
12	AC-G53	1292	1
	3mm ALUM. PLATE		



美特鋁質有限公司  
MIDI Aluminium Fabricator Ltd.

工程號	J858	類別		物料號	-	
地盘	康城11期	制圖	K. C	2023-11-22	圖號	J858-AG-R02
图纸名称	格栅组装图	復核	-	-	數量	1
材料	-	批准	-	-	單件重量	(KG)

修改  
日期

採用工廠  
材料颜色 -

地盤 ✓

圖號

數量

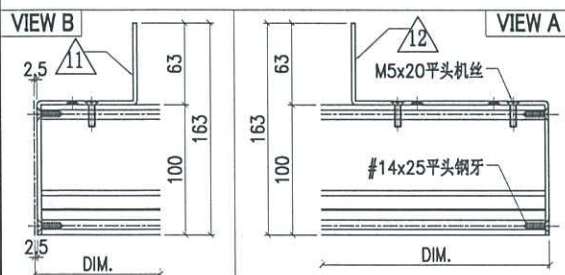
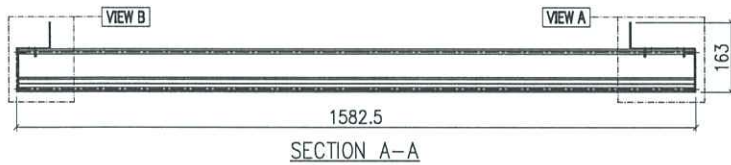
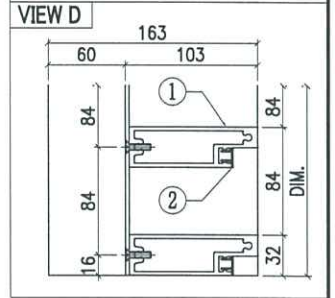
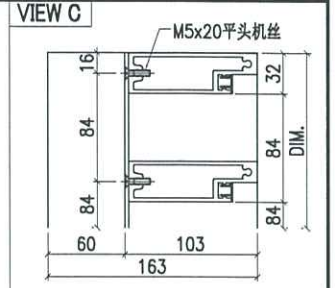
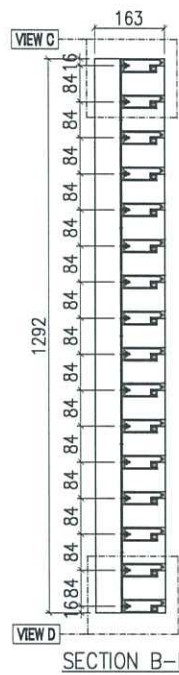
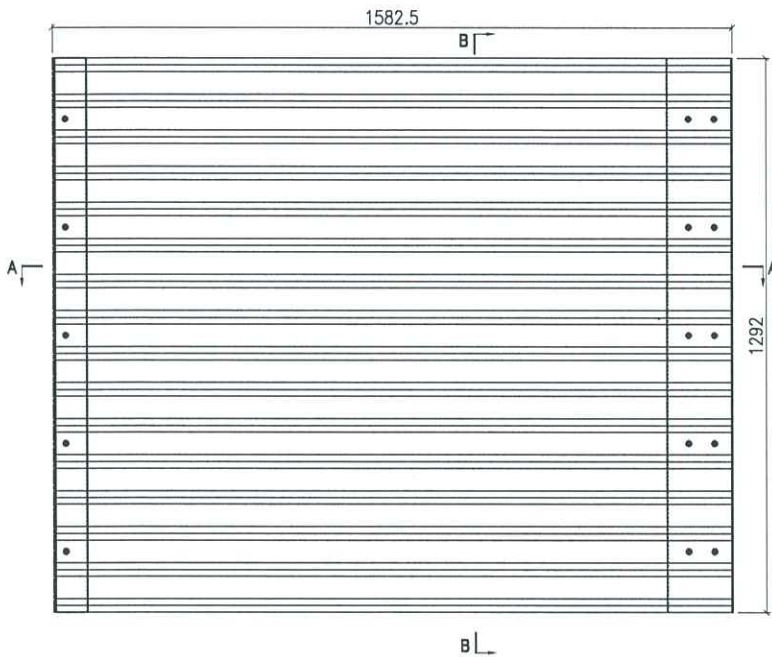

○ ALUM. EXTRUSION			
ITEM	FAB. DWG NO.	LENGTH (mm)	QTY
1	X86361-G02-01	1574	16
2	X86362-G01-01	1574	16

◇ OTHERS (ALUM. & G.M.S. PARTS)			
ITEM	FAB. DWG NO.	LENGTH (mm)	QTY
11	AC-G51	1292	1
	3mm ALUM. PLATE		
12	AC-G54	1292	1
	3mm ALUM. PLATE		





美特鋁質有限公司  
MIDI Aluminium Fabricator Ltd.

工程號	J858	類別		物料號	-	
地盘	康城11期	制圖	K. C	2023-11-22	圖號	J858-AG-R04
图纸名称	格栅组装图	復核	-	-	數量	1
修改日期		材料	-	-	單件重量	- (KG)

採用工廠	地盤	✓
材料颜色	-	

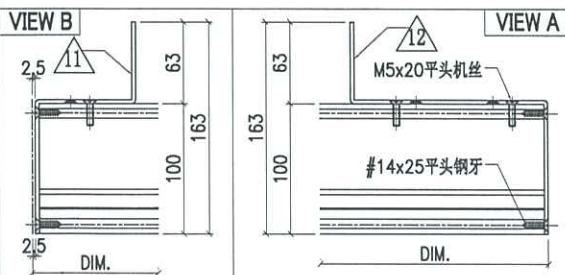
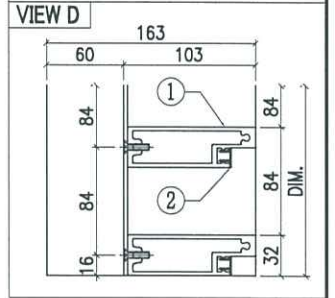
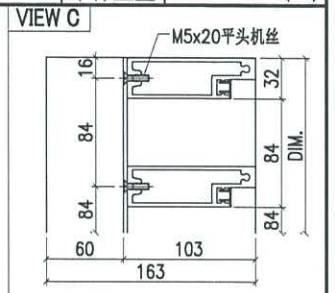
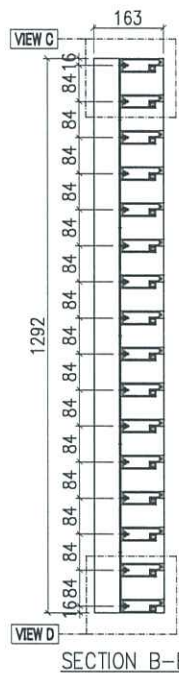
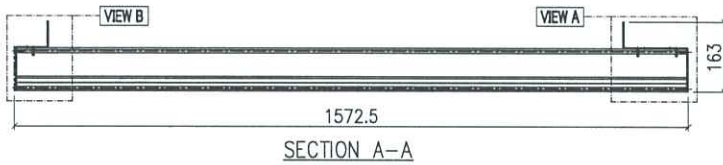
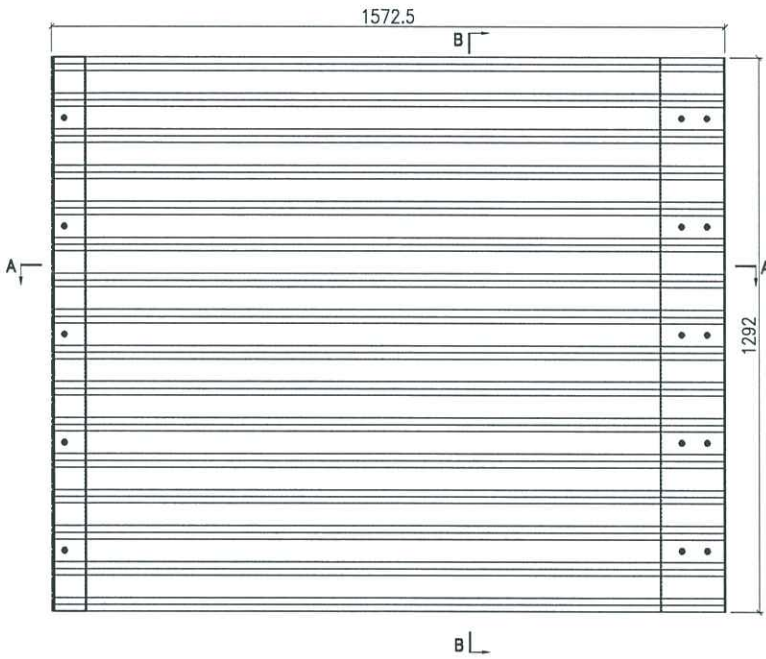

○ ALUM. EXTRUSION			
ITEM	FAB. DWG NO.	LENGTH (mm)	QTY
1	X86361-G02-02	1564	16
2	X86362-G01-02	1564	16

◇ OTHERS (ALUM. & G.M.S. PARTS)			
ITEM	FAB. DWG NO.	LENGTH (mm)	QTY
11	AC-G51	1292	1
	3mm ALUM. PLATE		
12	AC-G54	1292	1
	3mm ALUM. PLATE		



美特鋁質有限公司  
MIDI Aluminium Fabricator Ltd.

工程號	J858	類別		物料號	-		
地盘	康城11期	制圖	K. C	2023-11-22	圖號	J858-AG-R05	
修改		採用工廠	✓	圖紙名稱	格柵組裝圖	數量	1
日期		材料顏色	-	材料	-	單件重量	- (KG)
				復核	-		
				批准	-		

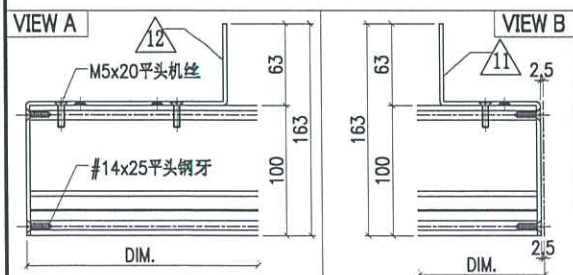
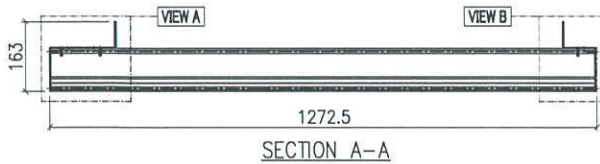
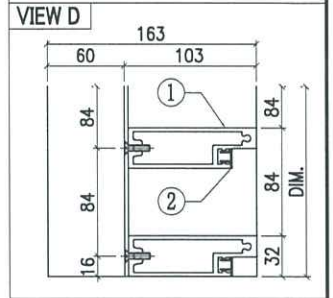
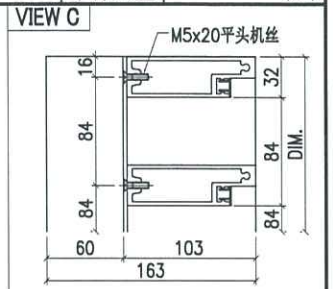
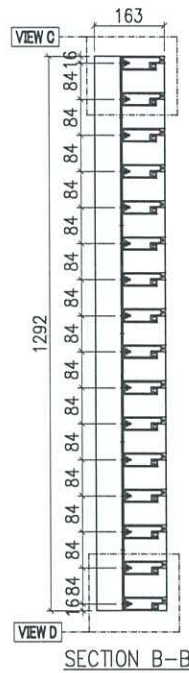
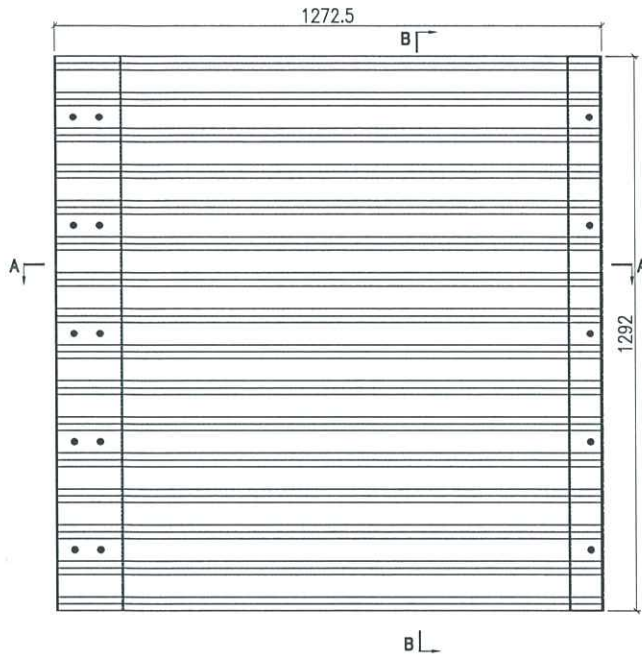

○ ALUM. EXTRUSION			
ITEM	FAB. DWG NO.	LENGTH (mm)	QTY
1	X86361-G01-03	1264	16
2	X86362-G01-03	1264	16

◇ OTHERS (ALUM. & G.M.S. PARTS)			
ITEM	FAB. DWG NO.	LENGTH (mm)	QTY
11	AC-G52	1292	1
	3mm ALUM. PLATE		
12	AC-G53	1292	1
	3mm ALUM. PLATE		







美特鋁質有限公司  
MIDI Aluminium Fabricator Ltd.

工程號	J858	類別		物料號	-	
地盘	康城11期	制圖	K. C	2023-11-22	圖號	J858-AG-R08
修改		採用工廠			數量	2
日期		材料颜色	-		單件重量	- (KG)
		图纸名称	格栅组装图	復核	-	
		材料	-	批准	-	

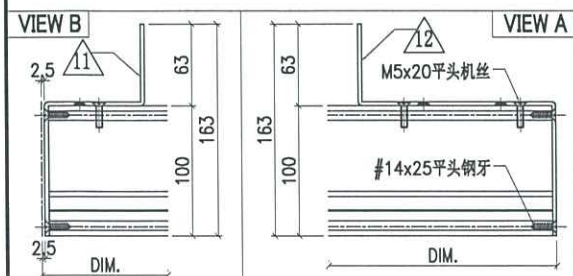
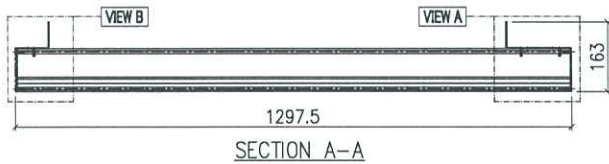
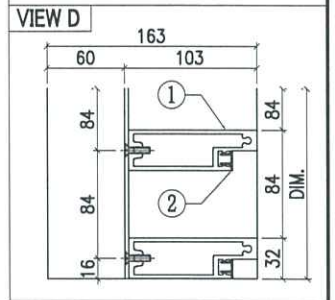
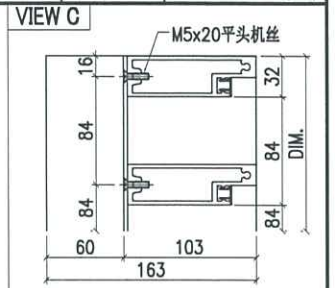
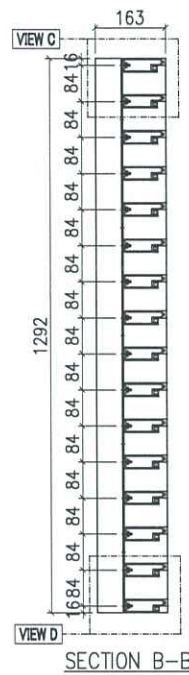
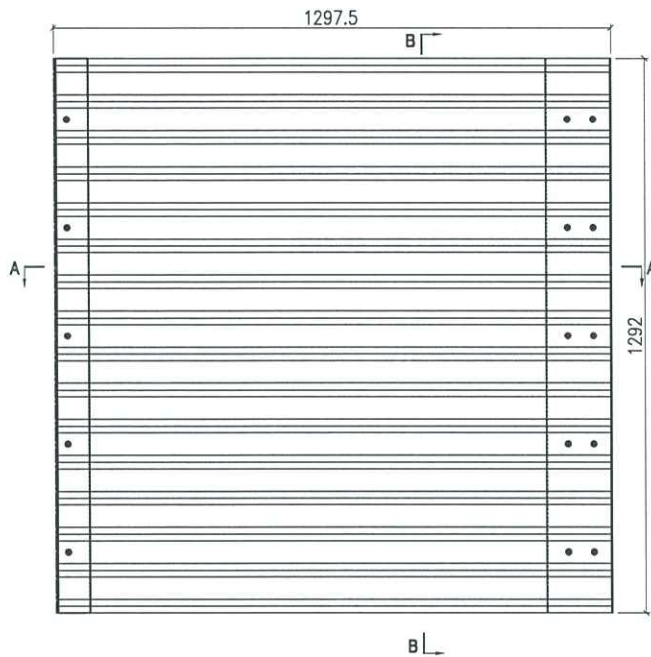

○ ALUM. EXTRUSION			
ITEM	FAB. DWG NO.	LENGTH (mm)	QTY
1	X86361-G02-04	1289	16
2	X86362-G01-04	1289	16

◇ OTHERS (ALUM. & G.M.S. PARTS)			
ITEM	FAB. DWG NO.	LENGTH (mm)	QTY
11	AC-G51	1292	1
	3mm ALUM. PLATE		
12	AC-G54	1292	1
	3mm ALUM. PLATE		



美特鋁質有限公司  
MIDI Aluminium Fabricator Ltd.

工程號	J858	類別		物料號	-	
地盘	康城11期	制圖	K. C	2023-11-22	圖號	J858-AG-R09
图纸名称	格栅组装图	復核	-	-	數量	1
修改日期		材料	-	-	單件重量	(KG)

採用工廠	地盘	✓
材料颜色	-	

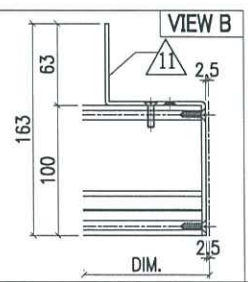
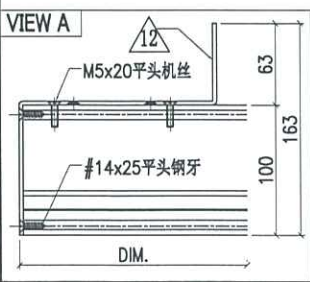
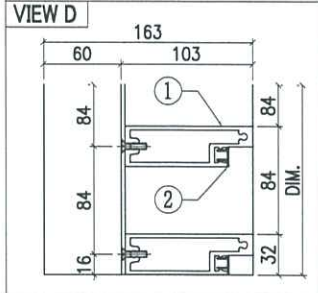
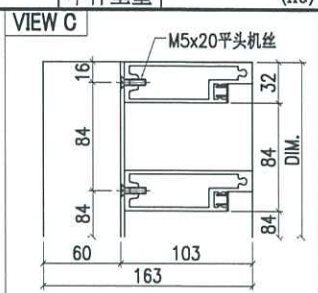
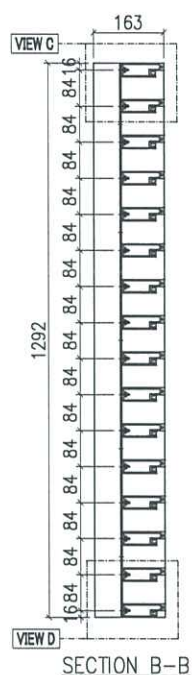
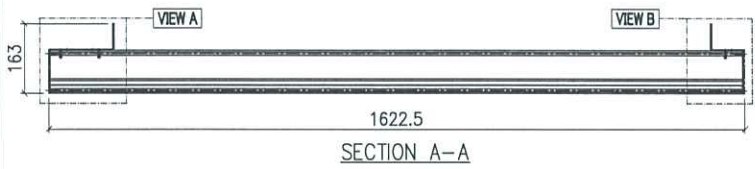
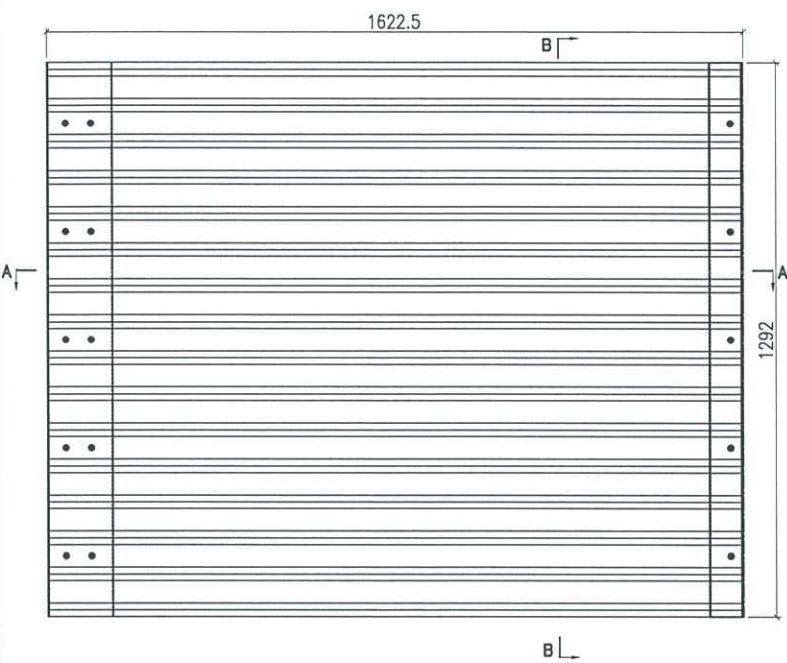

○ ALUM. EXTRUSION			
ITEM	FAB. DWG NO.	LENGTH (mm)	QTY
1	X86361-G01-05	1614	16
2	X86362-G01-05	1614	16

◇ OTHERS (ALUM. & G.M.S. PARTS)			
ITEM	FAB. DWG NO.	LENGTH (mm)	QTY
11	AC-G52	1292	1
	3mm ALUM. PLATE		
12	AC-G53	1292	1
	3mm ALUM. PLATE		



美特鋁質有限公司  
MIDI Aluminium Fabricator Ltd.

工程號	J858	類別		物料號	-	
地盘	康城11期	制圖	K. C	2023-11-22	圖號	J858-AG-R10
图纸名称	格栅组装图	復核	-	-	數量	1
材料	-	批准	-	-	單件重量	- (KG)

修改日期		採用工廠		地盘	✓
		材料颜色	-		

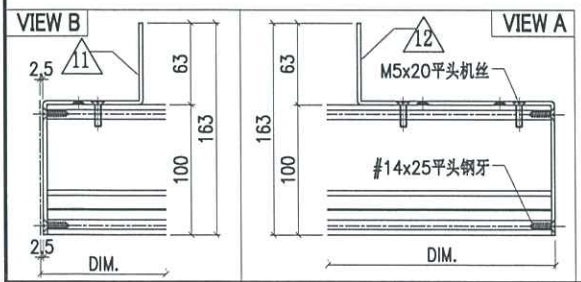
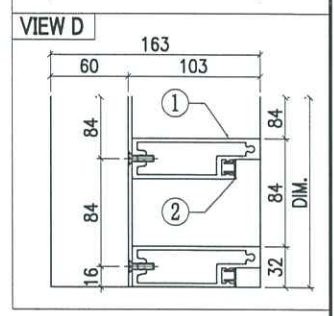
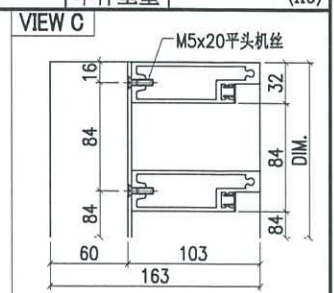
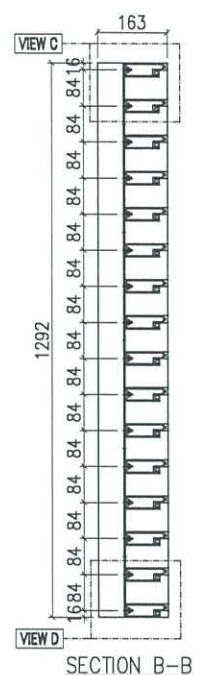
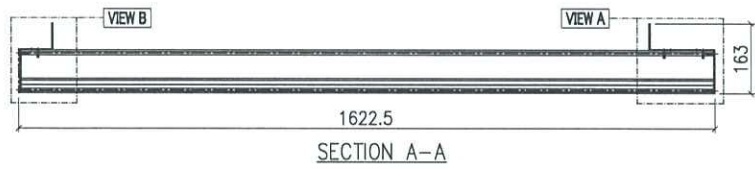
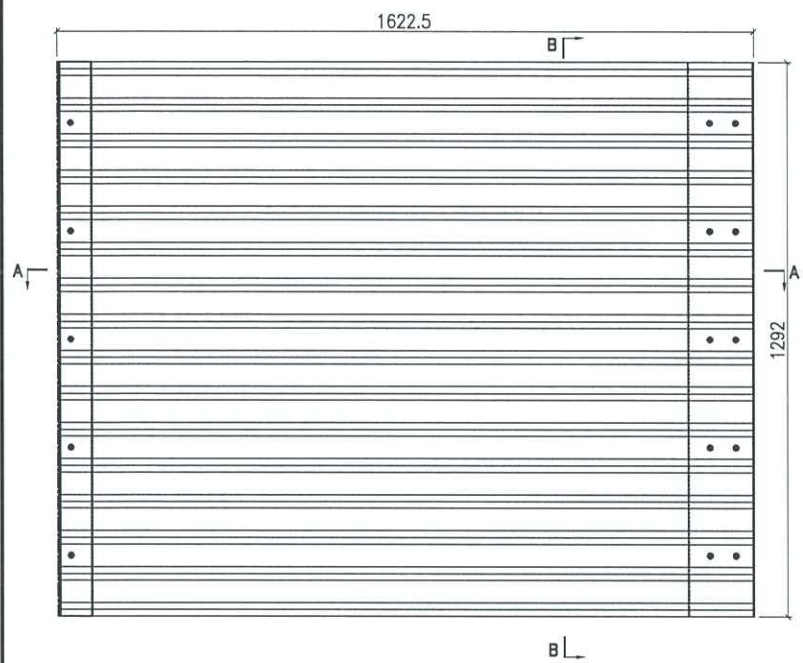

○ ALUM. EXTRUSION			
ITEM	FAB. DWG NO.	LENGTH (mm)	QTY
1	X86361-G02-05	1614	16
2	X86362-G01-05	1614	16

◇ OTHERS (ALUM. & G.M.S. PARTS)			
ITEM	FAB. DWG NO.	LENGTH (mm)	QTY
11	AC-G51	1292	1
	3mm ALUM. PLATE		
12	AC-G54	1292	1
	3mm ALUM. PLATE		



美特鋁質有限公司  
MIDI Aluminium Fabricator Ltd.

工程號	J858	類別		物料號	-		
地盘	康城11期	制圖	K. C	2023-11-22	圖號	J858-AG-R11	
修改日期		採用工廠	✓	圖紙名稱	格栅组装图	數量	1
		材料颜色	-	材料	-	批准	-
						單件重量	- (KG)

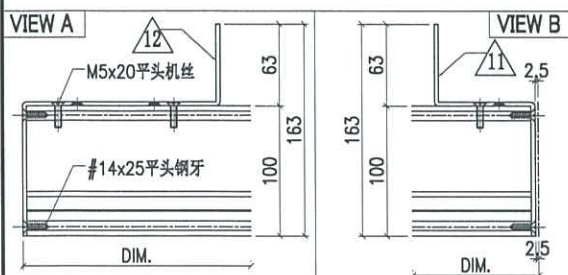
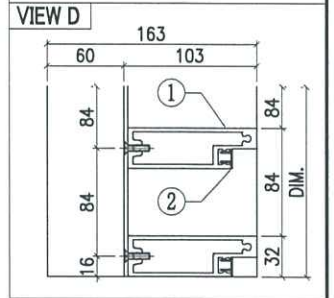
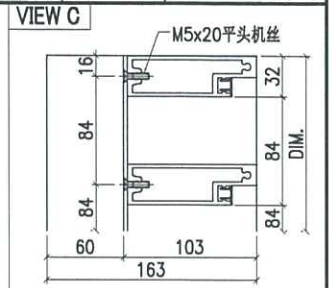
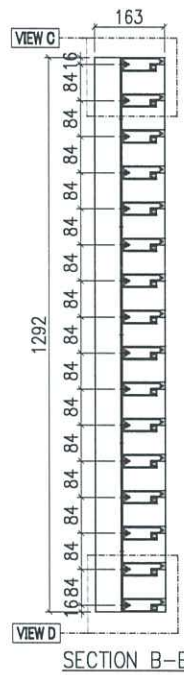
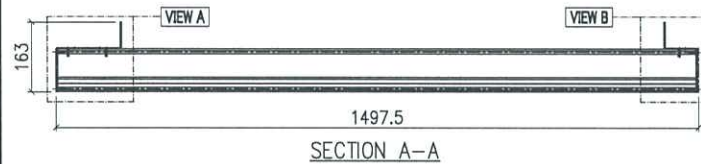
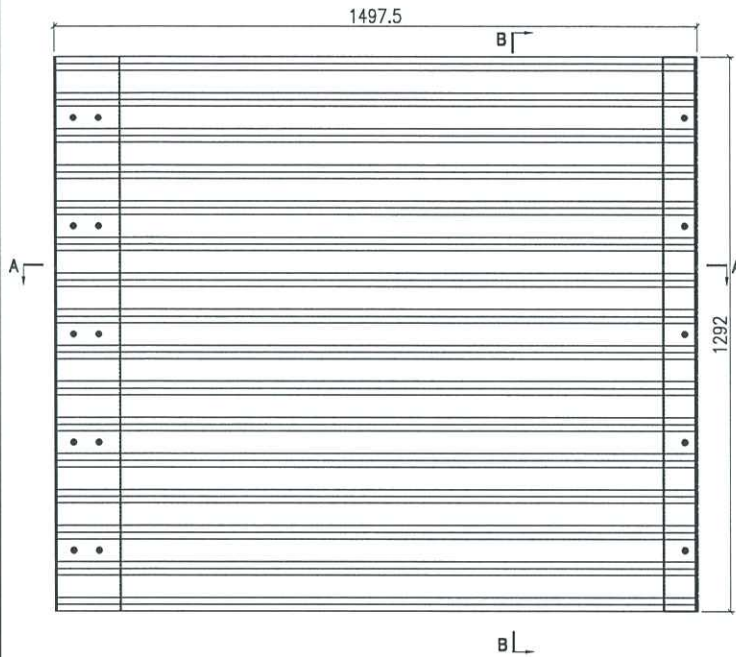

○ ALUM. EXTRUSION			
ITEM	FAB. DWG NO.	LENGTH (mm)	QTY
1	X86361-G01-06	1489	16
2	X86362-G01-06	1489	16

◇ OTHERS (ALUM. & G.M.S. PARTS)			
ITEM	FAB. DWG NO.	LENGTH (mm)	QTY
11	AC-G52	1292	1
	3mm ALUM. PLATE		
12	AC-G53	1292	1
	3mm ALUM. PLATE		



美特鋁質有限公司  
MIDI Aluminium Fabricator Ltd.

工程號	J858	類別		物料號	-	
地盘	康城11期	制圖	K. C	2023-11-22	圖號	J858-AG-R12
图纸名称	格栅组装图	復核	-	-	數量	1
修改日期		材料	-	-	單件重量	- (KG)

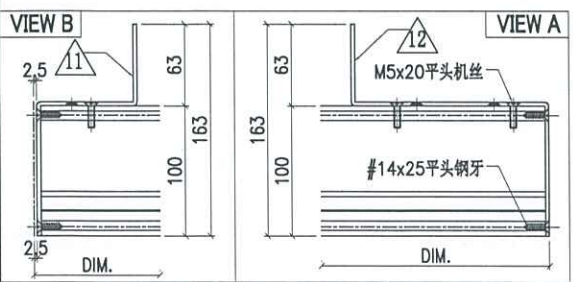
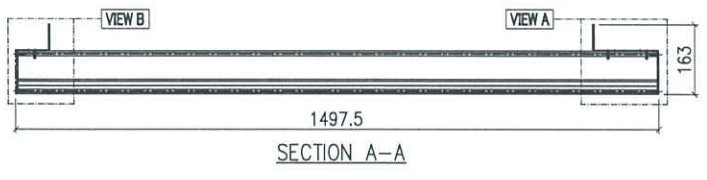
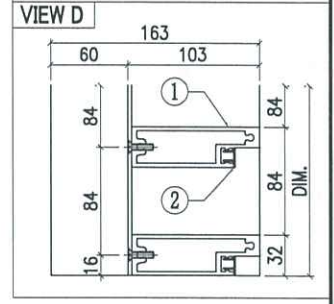
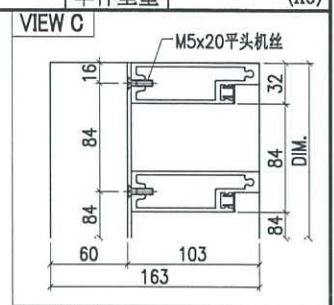
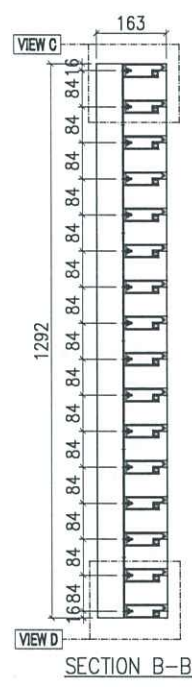
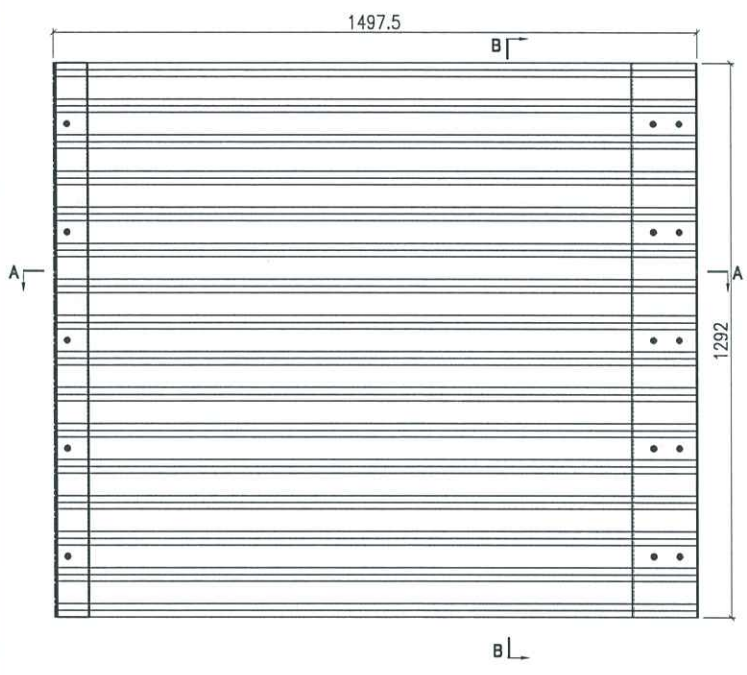

○ ALUM. EXTRUSION			
ITEM	FAB. DWG NO.	LENGTH (mm)	QTY
1	X86361-G02-06	1489	16
2	X86362-G01-06	1489	16

◇ OTHERS (ALUM. & G.M.S. PARTS)			
ITEM	FAB. DWG NO.	LENGTH (mm)	QTY
11	AC-G51	1292	1
	3mm ALUM. PLATE		
12	AC-G54	1292	1
	3mm ALUM. PLATE		



美特鋁質有限公司  
MIDI Aluminium Fabricator Ltd.

工程號	J858	類別		物料號	-		
地盘	康城11期	制圖	K. C	2023-11-22	圖號	J858-AG-R13	
修改日期		採用工廠	✓	圖紙名稱	格栅组装图	數量	2
		材料颜色	-	材料	-	單件重量	- (KG)
				復核	-		
				批准	-		

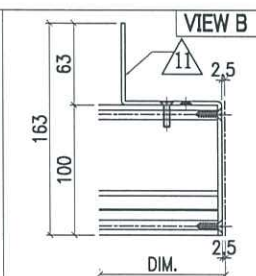
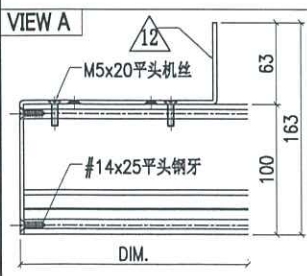
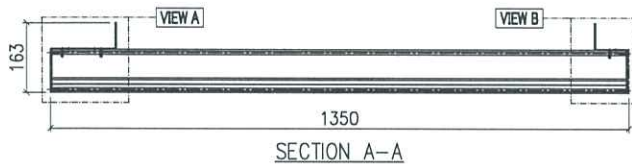
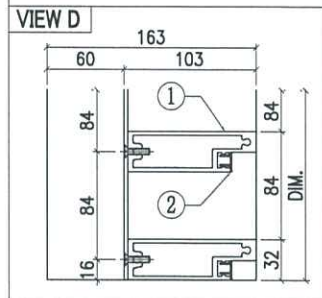
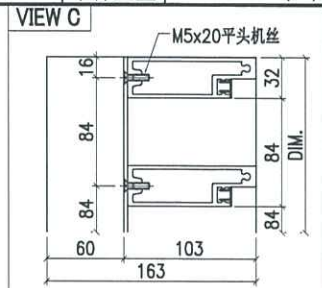
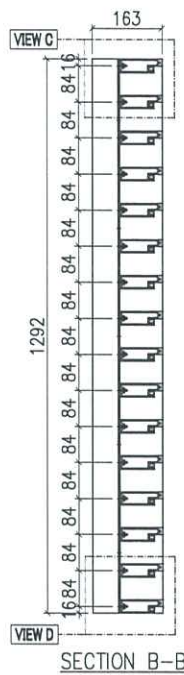
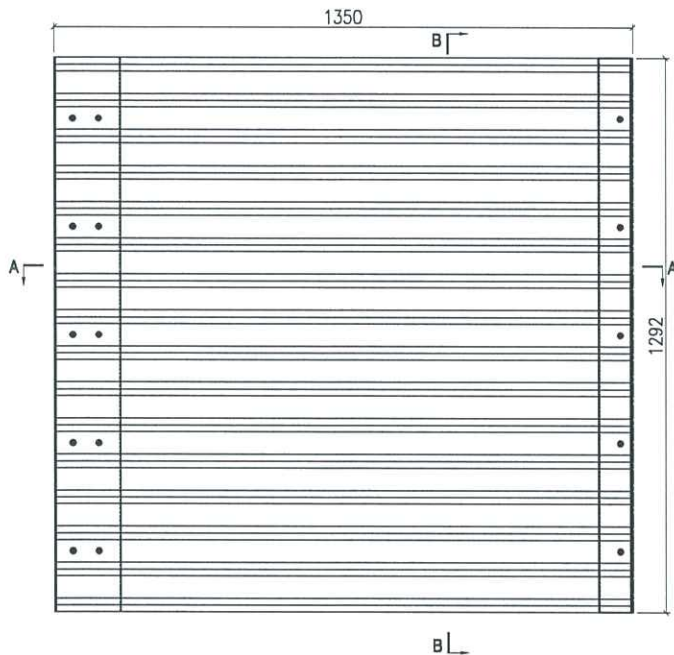

○ ALUM. EXTRUSION			
ITEM	FAB. DWG NO.	LENGTH (mm)	QTY
1	X86361-G01-07	1341.5	16
2	X86362-G01-07	1341.5	16

◇ OTHERS (ALUM. & G.M.S. PARTS)			
ITEM	FAB. DWG NO.	LENGTH (mm)	QTY
11	AC-G52	1292	1
	3mm ALUM. PLATE		
12	AC-G53	1292	1
	3mm ALUM. PLATE		



美特鋁質有限公司  
MIDI Aluminium Fabricator Ltd.

工程號	J858	類別		物料號	-		
地盘	康城11期	制圖	K. C	2023-11-22	圖號	J858-AG-R14	
修改		採用工廠	✓	圖紙名稱	格栅组装图	數量	2
日期		材料颜色	-	材料	-	單件重量	- (KG)
				復核	-		
				批准	-		

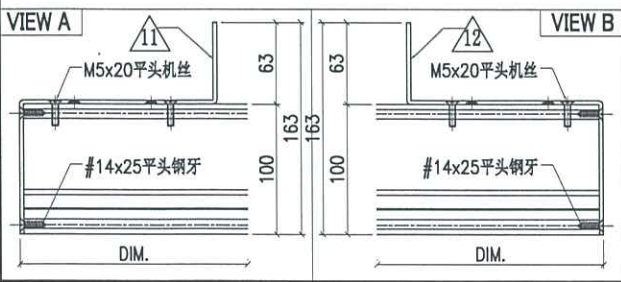
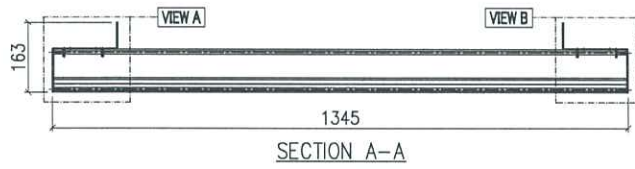
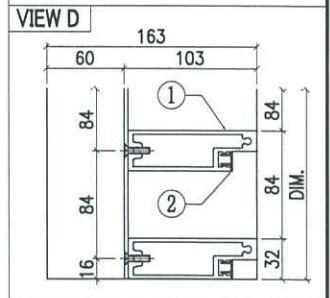
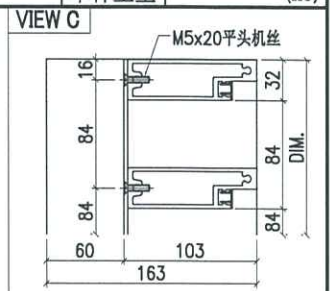
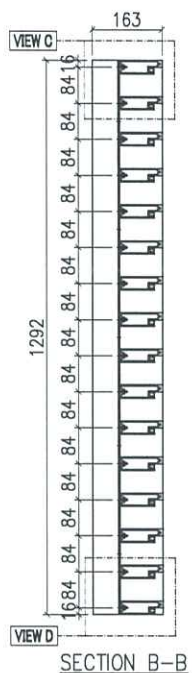
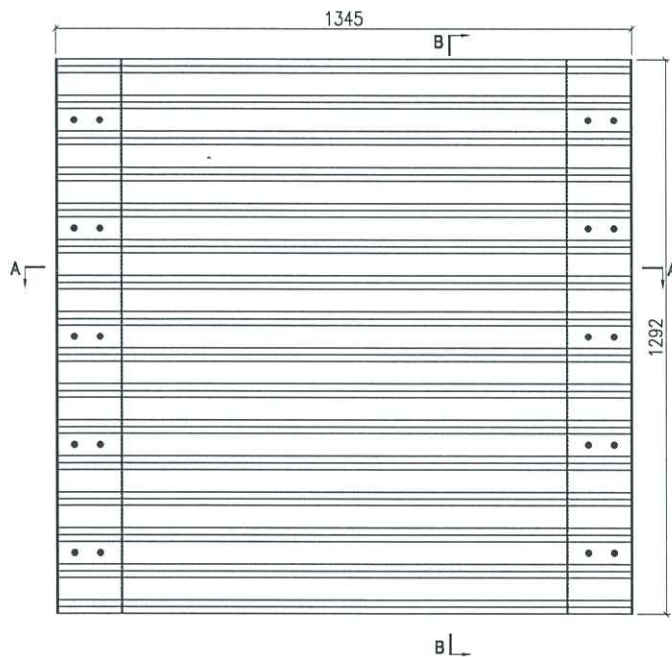

○ ALUM. EXTRUSION			
ITEM	FAB. DWG NO.	LENGTH (mm)	QTY
1	X86361-G03-01	1339	16
2	X86362-G01-08	1339	16

◇ OTHERS (ALUM. & G.M.S. PARTS)			
ITEM	FAB. DWG NO.	LENGTH (mm)	QTY
11	AC-G53	1292	1
	3mm ALUM. PLATE		
12	AC-G54	1292	1
	3mm ALUM. PLATE		



美特鋁質有限公司  
MIDI Aluminium Fabricator Ltd.

工程號	J858	類別		物料號	-		
地盘	康城11期	制圖	K. C	2023-11-22	圖號	J858-AG-R15	
修改日期		圖紙名稱	格栅组裝圖	復核	-	數量	1
		材料	-	批准	-	單件重量	- (KG)

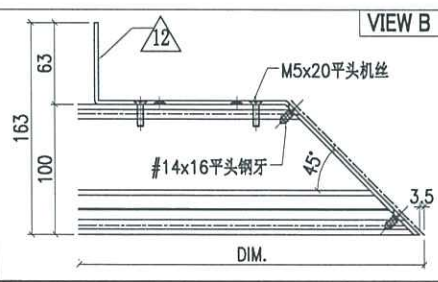
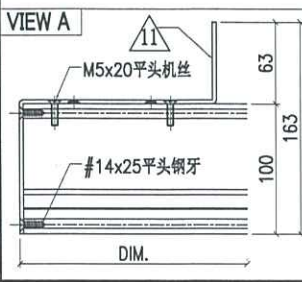
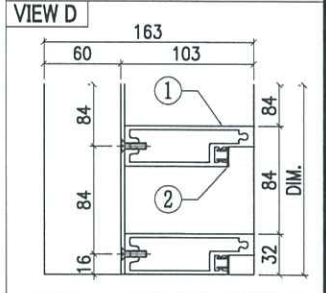
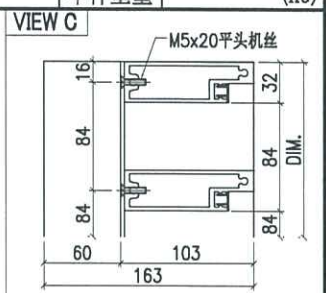
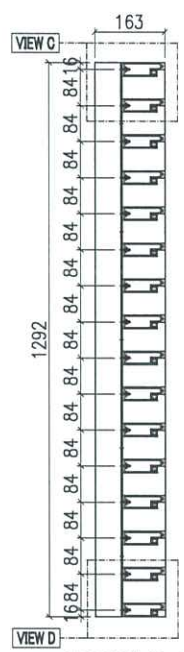
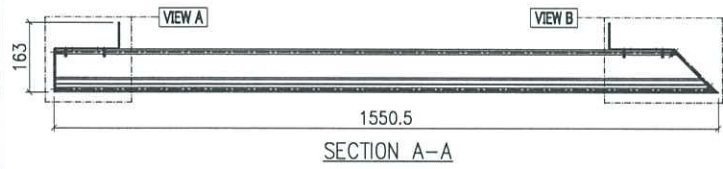
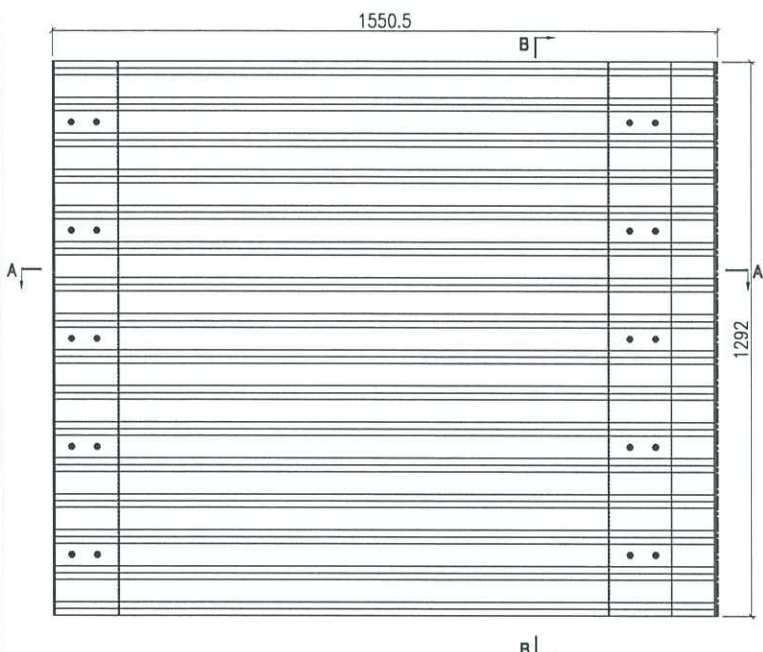

○ ALUM. EXTRUSION			
ITEM	FAB. DWG NO.	LENGTH (mm)	QTY
1	X86361-G04-01	1539.5	16
2	X86362-G02-01	1520.5	16

◇ OTHERS (ALUM. & G.M.S. PARTS)			
ITEM	FAB. DWG NO.	LENGTH (mm)	QTY
11	AC-G53	1292	1
	3mm ALUM. PLATE		
12	AC-G56	1292	1
	3mm ALUM. PLATE		





美特鋁質有限公司  
MIDI Aluminium Fabricator Ltd.

工程號	J858	類別		物料號	-		
地盘	康城11期	制圖	K. C	2023-11-22	圖號	J858-AG-R17	
修改日期		图纸名称	格栅组装图	復核	-	數量	1
		材料	-	批准	-	單件重量	- (KG)

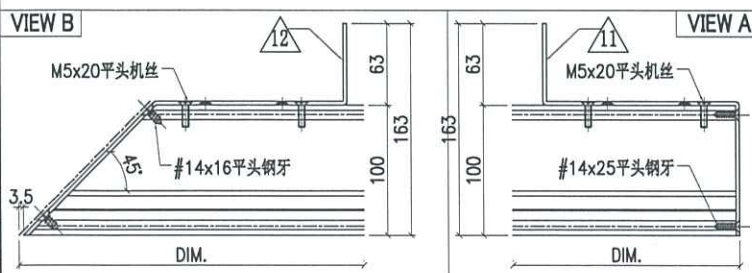
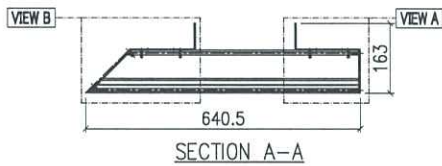
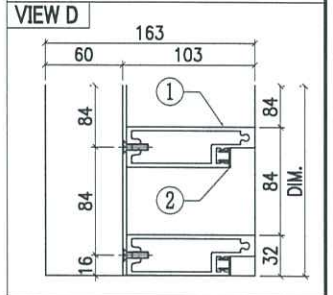
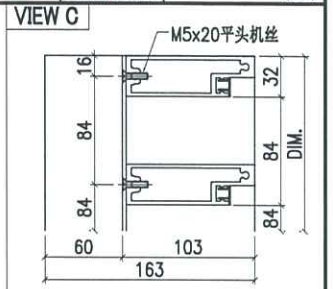
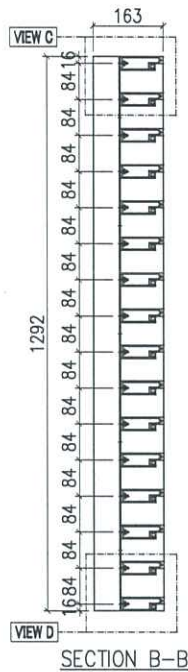
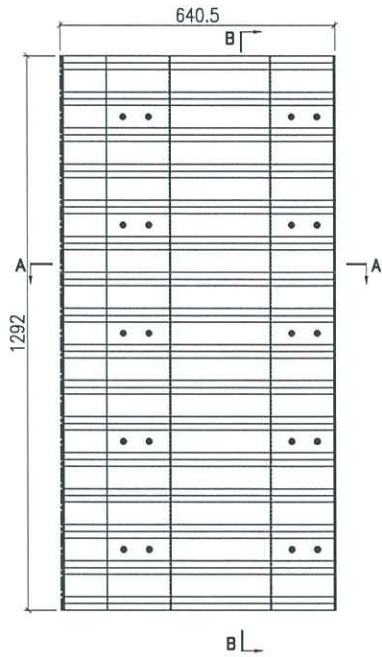

○ ALUM. EXTRUSION			
ITEM	FAB. DWG NO.	LENGTH (mm)	QTY
1	X86361-G06-01	629.5	16
2	X86362-G03-01	610.5	16

◇ OTHERS (ALUM. & G.M.S. PARTS)			
ITEM	FAB. DWG NO.	LENGTH (mm)	QTY
11	AC-G54	1292	1
	3mm ALUM. PLATE		
12	AC-G55	1292	1
	3mm ALUM. PLATE		



美特鋁質有限公司  
MIDI Aluminium Fabricator Ltd.

工程號	J858	類別		物料號	-	
地盘	康城11期	制圖	K. C	2023-11-22	圖號	J858-AG-R18
修改日期		採用工廠			數量	2
		地盘	✓		單件重量	- (KG)
		材料颜色	-			
		图纸名称	格栅组装图	復核	-	
		材料	-	批准	-	

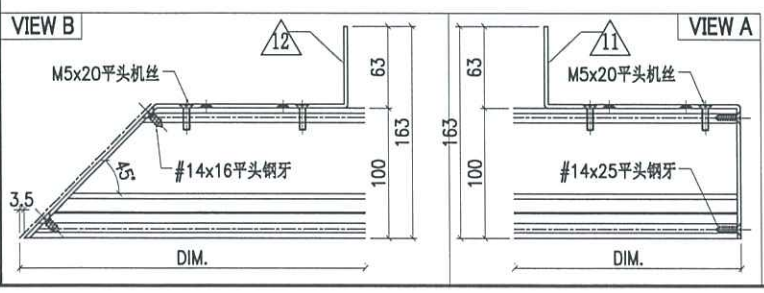
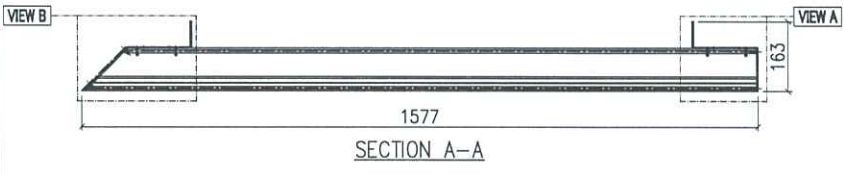
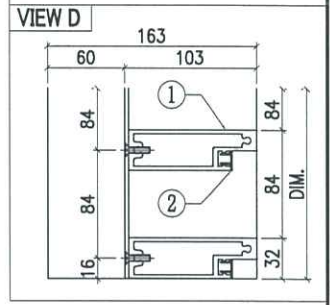
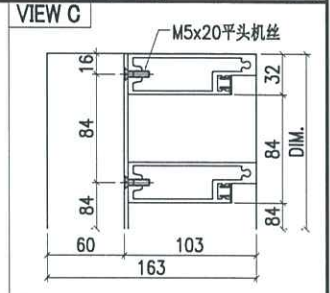
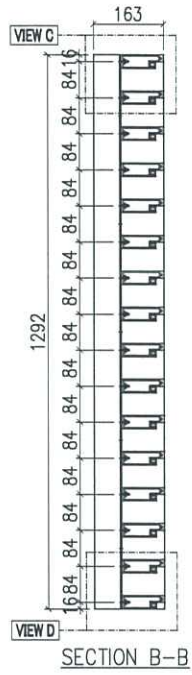
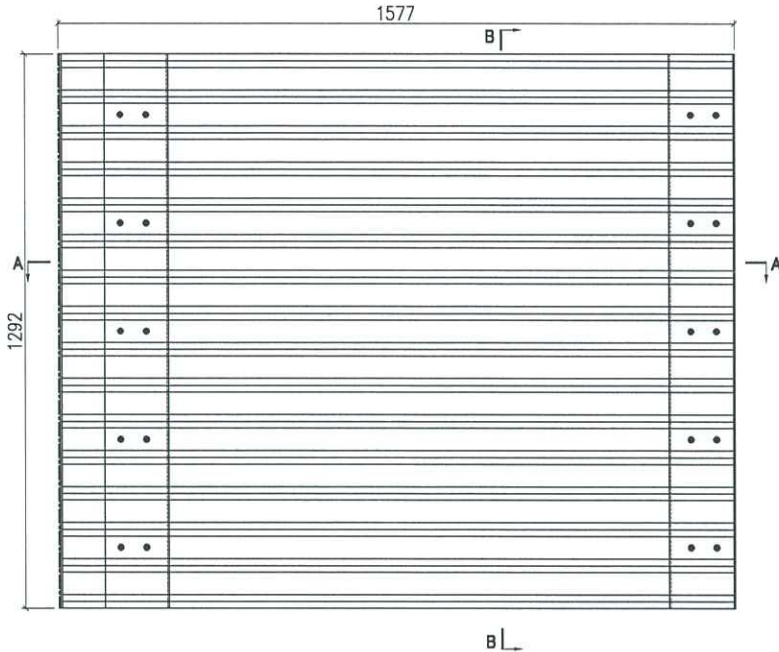

○ ALUM. EXTRUSION			
ITEM	FAB. DWG NO.	LENGTH (mm)	QTY
1	X86361-G06-02	1566	16
2	X86362-G03-02	1547	16

◇ OTHERS (ALUM. & G.M.S. PARTS)			
ITEM	FAB. DWG NO.	LENGTH (mm)	QTY
11	AC-G54	1292	1
	3mm ALUM. PLATE		
12	AC-G55	1292	1
	3mm ALUM. PLATE		



美特鋁質有限公司  
MIDI Aluminium Fabricator Ltd.

修改		採用工廠	地盤	✓	工程號	J858	類別		物料號	-	
日期		材料顏色	-		地盤	康城11期	制圖	K. C	2023-11-22	圖號	J858-AG-R19
					图纸名称	格栅组装图	復核	-	-	數量	1
					材料	-	批准	-	-	單件重量	- (KG)

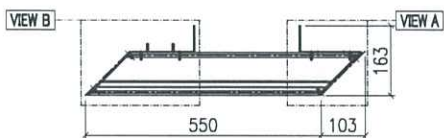
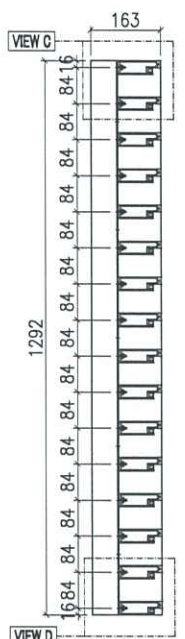
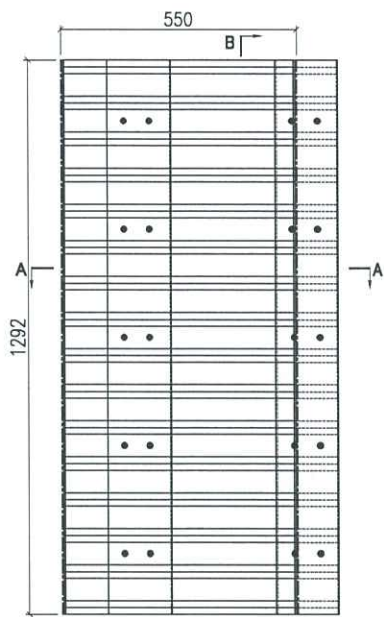

SECTION A-A

VIEW C

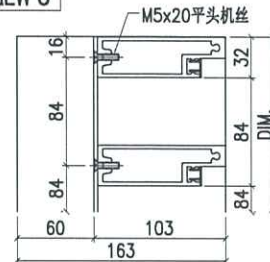

VIEW D

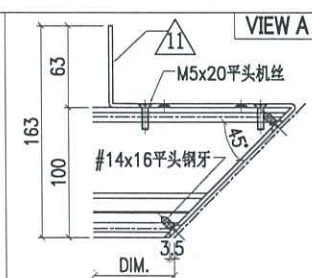
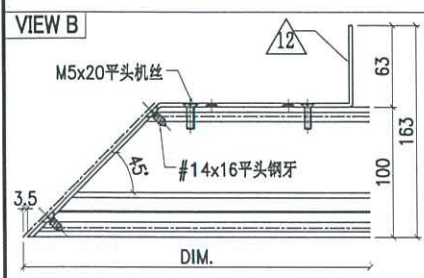
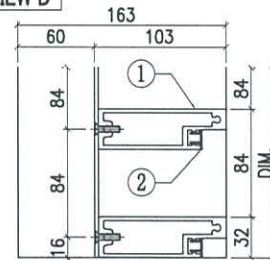

○ ALUM. EXTRUSION			
ITEM	FAB. DWG NO.	LENGTH (mm)	QTY
1	X86361-G07-01	634.5	16
2	X86362-G04-01	543.8	16

◇ OTHERS (ALUM. & G.M.S. PARTS)			
ITEM	FAB. DWG NO.	LENGTH (mm)	QTY
11	AC-G58	1292	1
	3mm ALUM. PLATE		
12	AC-G55	1292	1
	3mm ALUM. PLATE		

工程號	J858	類別		物料號	-	
地盘	康城11期	制圖	K. C	2023-11-22	圖號	J858-AG-R20
採用工廠	地盘	✓	图纸名称	格栅组装图	復核	-
日期	材料颜色	-	材料	-	批准	-
					數量	1
					單件重量	- (KG)

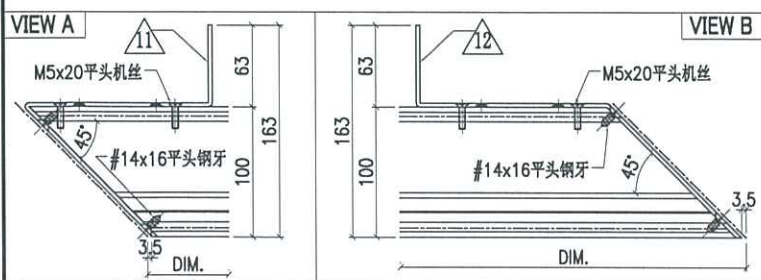
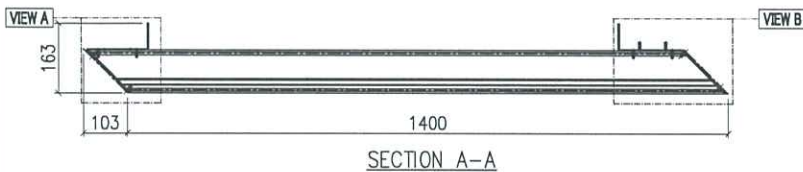
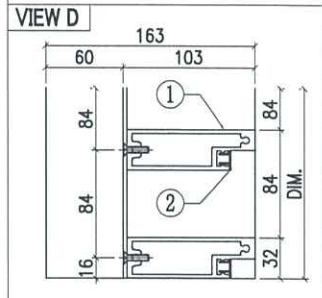
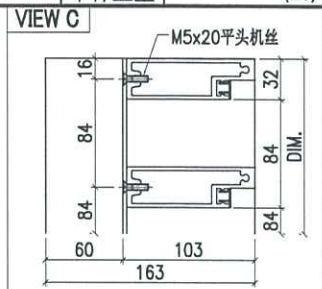
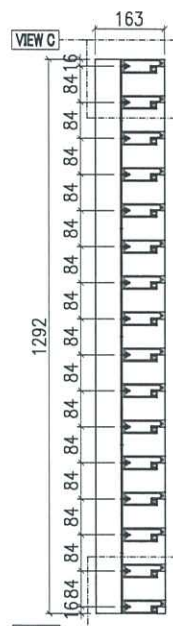
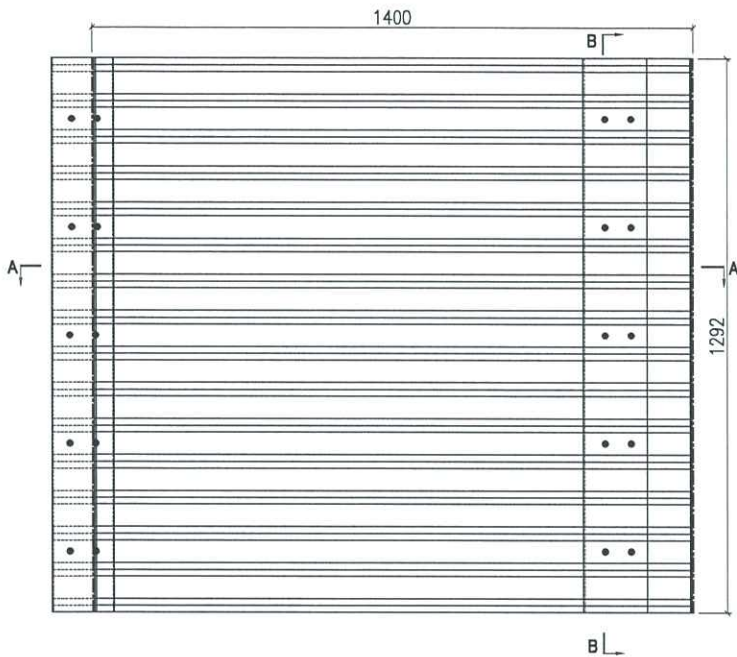

○ ALUM. EXTRUSION			
ITEM	FAB. DWG NO.	LENGTH (mm)	QTY
1	X86361-G08-01	1484.5	16
2	X86362-G05-01	1393.8	16

◇ OTHERS (ALUM. & G.M.S. PARTS)			
ITEM	FAB. DWG NO.	LENGTH (mm)	QTY
11	AC-G57	1292	1
	3mm ALUM. PLATE		
12	AC-G56	1292	1
	3mm ALUM. PLATE		



美特鋁質有限公司  
MIDI Aluminium Fabricator Ltd.

工程號	J858	類別		物料號	-		
地盘	康城11期	制圖	K. C	2023-11-23	圖號	X86361-G01	
修改		採用工廠	✓ 地盘	图纸名称	鋁料加工图	復核	-
日期		材料颜色	香槟金 (ECD3X1009 9S-XF1)	材料	X86361	批准	-
						數量	-
						單件重量	- (KG)

部件编号	L	数量
X86361-G01-01	1574	16
X86361-G01-02	1564	16
X86361-G01-03	1264	16
X86361-G01-04	1289	32
X86361-G01-05	1614	16
X86361-G01-06	1489	16
X86361-G01-07	1341.5	32

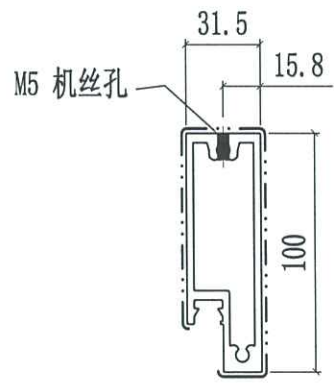
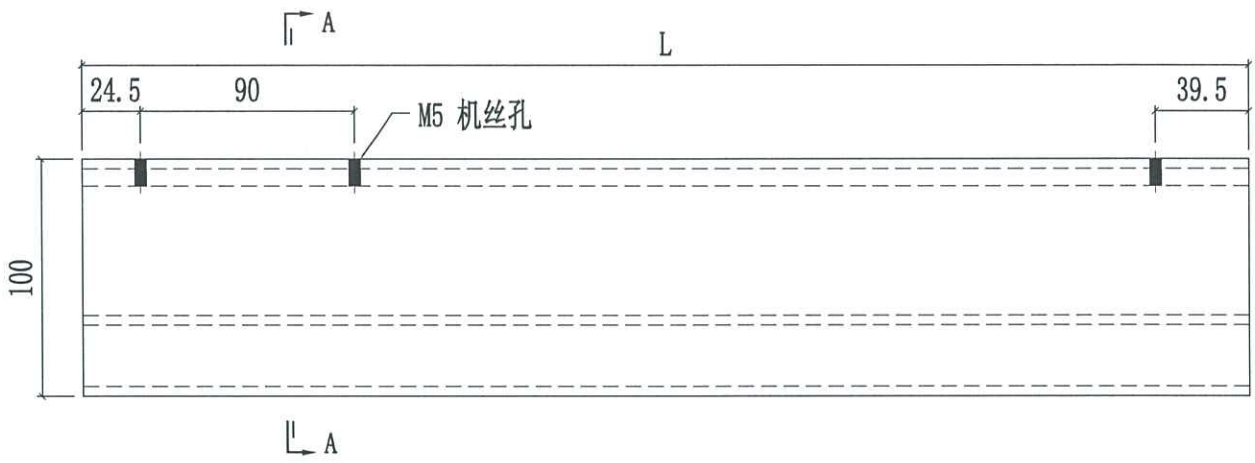

SECTION A-A



美特鋁質有限公司  
MIDI Aluminium Fabricator Ltd.

工程號	J858	類別		物料號	-		
地盘	康城11期	制圖	K. C	2023-11-23	圖號	X86361-G02	
修改		採用工廠	✓	地盤	圖紙名稱	鋁料加工圖	
日期		材料顏色	香槟金 (ECC03X1009 9S-XF1)	材料	X86361	復核	-
						批准	-
						數量	-
						單件重量	- (KG)

部件编号	L	数量
X86361-G02-01	1574	16
X86361-G02-02	1564	16
X86361-G02-03	1264	16
X86361-G02-04	1289	32
X86361-G02-05	1614	16
X86361-G02-06	1489	16

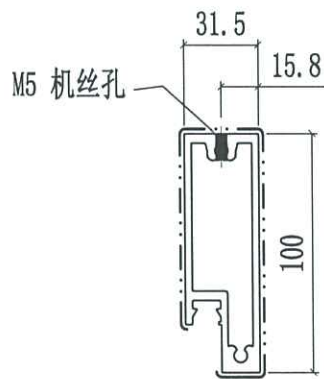
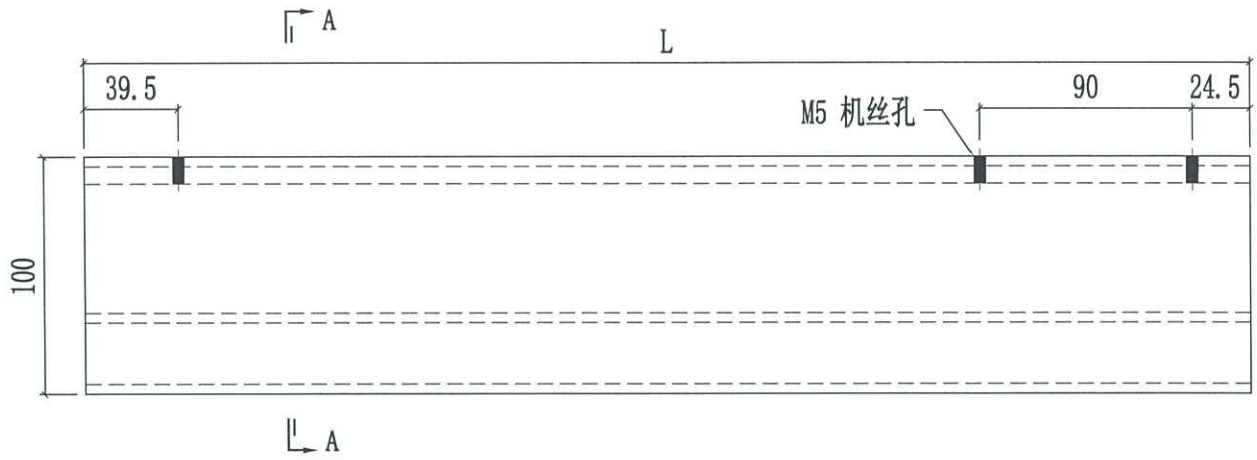

SECTION A-A



美特鋁質有限公司  
MIDI Aluminium Fabricator Ltd.

工程號	J858	類別		物料號	-				
地盘	康城11期	制圖	K. C	2023-11-23	圖號	X86361-G03			
修改日期		採用工廠	✓ 地盘	图纸名称	鋁料加工图	復核	-	數量	-
		材料颜色	香槟金 (ECD3X1009 9S-XF1)	材料	X86361	批准	-	單件重量	- (KG)

部件编号	L	数量
X86361-G03-01	1339	32

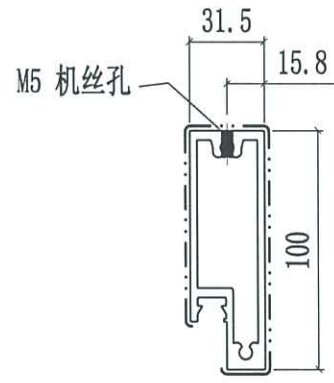
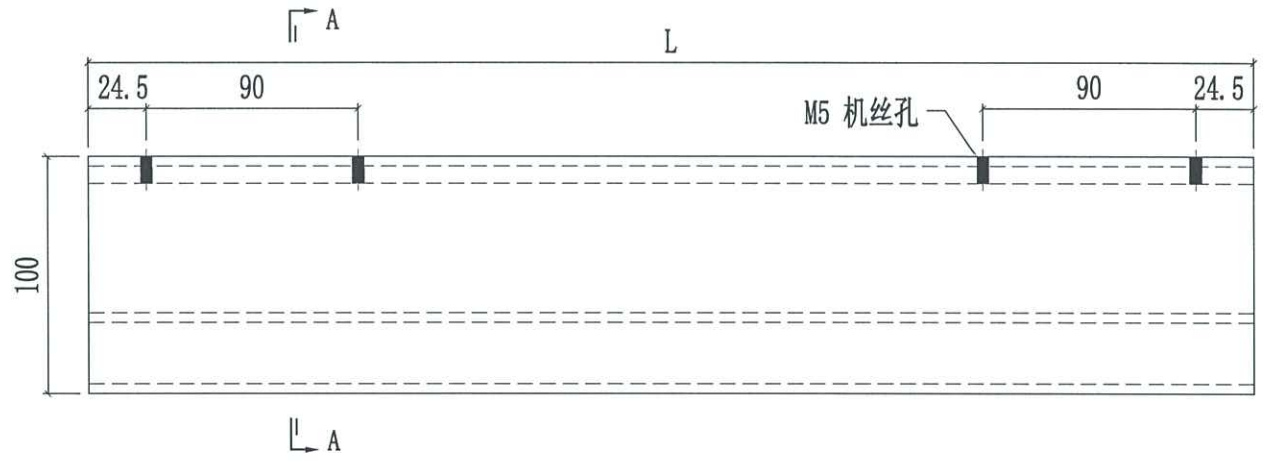

SECTION A-A



美特鋁質有限公司  
MIDI Aluminium Fabricator Ltd.

工程號	J858	類別		物料號	-				
地盘	康城11期	制圖	K. C	2023-11-23	圖號	X86361-G04			
修改		採用工廠	✓ 地盘	图纸名称	鋁料加工图	復核	-	數量	-
日期		材料颜色	香槟金 (ECD3X1009 9S-XF1)	材料	X86361	批准	-	單件重量	- (KG)

部件编号	L	数量
X86361-G04-01	1539.5	16

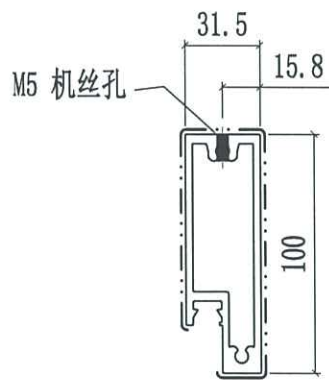
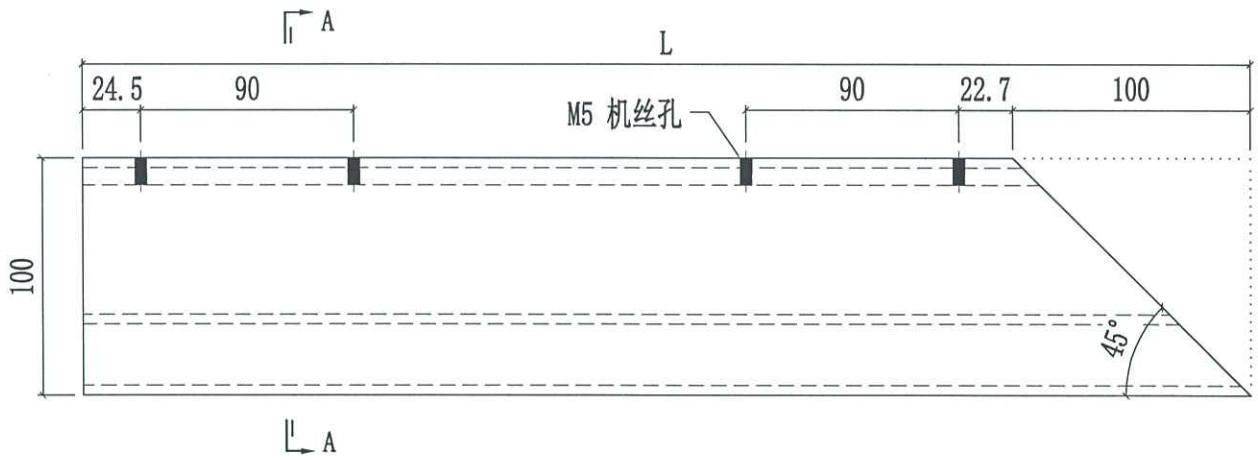

SECTION A-A



美特鋁質有限公司  
MIDI Aluminium Fabricator Ltd.

工程號	J858	類別		物料號	-		
地盘	康城11期	制圖	K. C	2023-11-23	圖號	X86361-G05	
修改日期		採用工廠	✓ 地盘	圖紙名稱	鋁料加工圖	數量	-
		材料顏色	香檳金 (ECD3X1009 9S-XF1)	材料	X86361	單件重量	- (KG)

部件编号	L	数量
X86361-G05-01	727	32

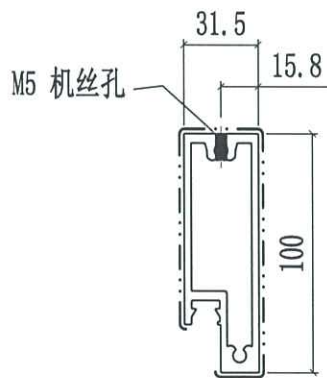
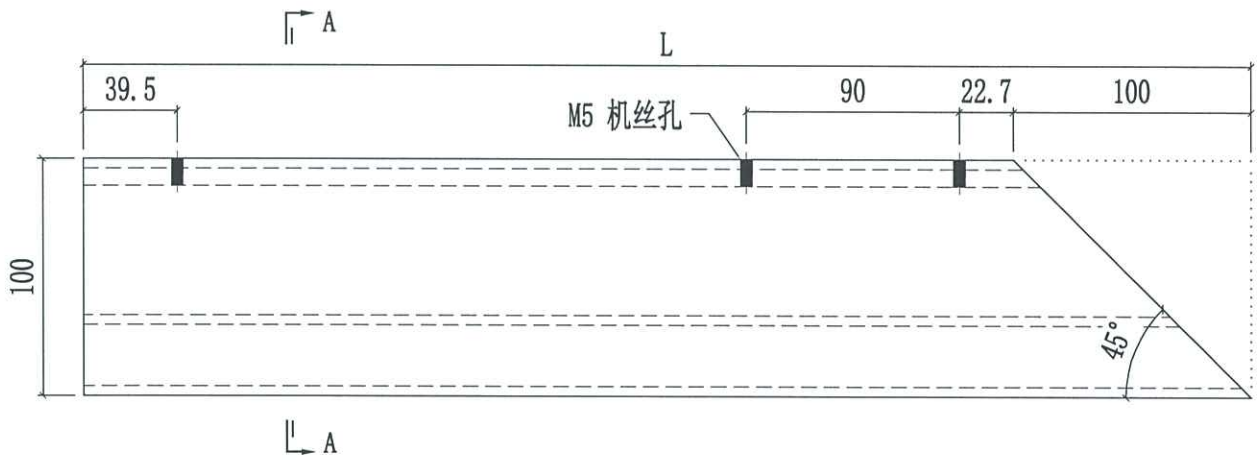

SECTION A-A



美特鋁質有限公司  
MIDI Aluminium Fabricator Ltd.

工程號	J858	類別		物料號	-							
地盘	康城11期	制圖	K. C	2023-11-23	圖號	X86361-G06						
修改		採用工廠	✓	地盤		圖紙名稱	鋁料加工圖	復核	-	-	數量	-
日期		材料顏色	香槟金 (ECD3X1009 9S-XP1)	材料	X86361	批准	-	-			單件重量	- (KG)

部件编号	L	数量
X86361-G06-01	629.5	16
X86361-G06-02	1566	32

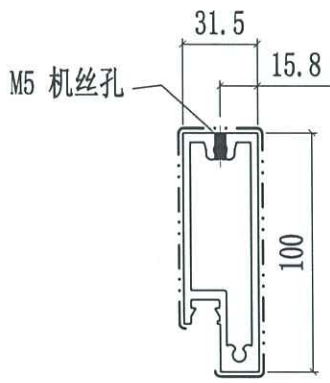
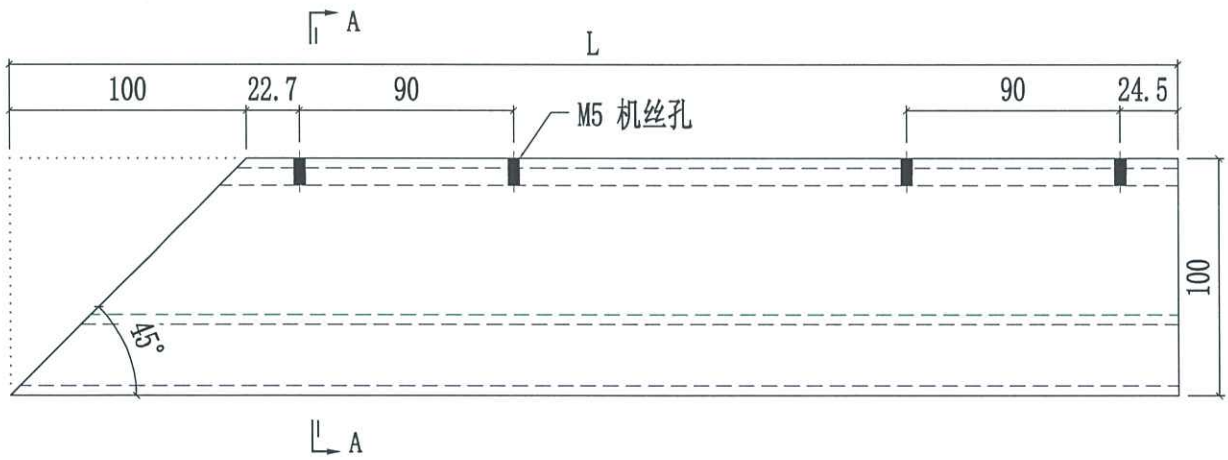

SECTION A-A



美特鋁質有限公司  
MIDI Aluminium Fabricator Ltd.

工程號	J858	類別		物料號	-							
地盘	康城11期	制圖	K. C	2023-11-23	圖號	X86361-G07						
修改		採用工廠	✓	地盤		圖紙名稱	鋁料加工圖	復核	-	-	數量	-
日期		材料顏色	香槟金 (ECD3X1009 GS-XF1)	材料	X86361	批准	-	-	單件重量	-	(KG)	

部件编号	L	数量
X86361-G07-01	634.5	16

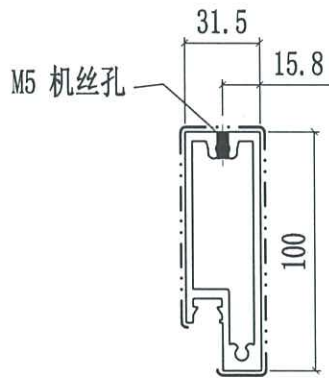
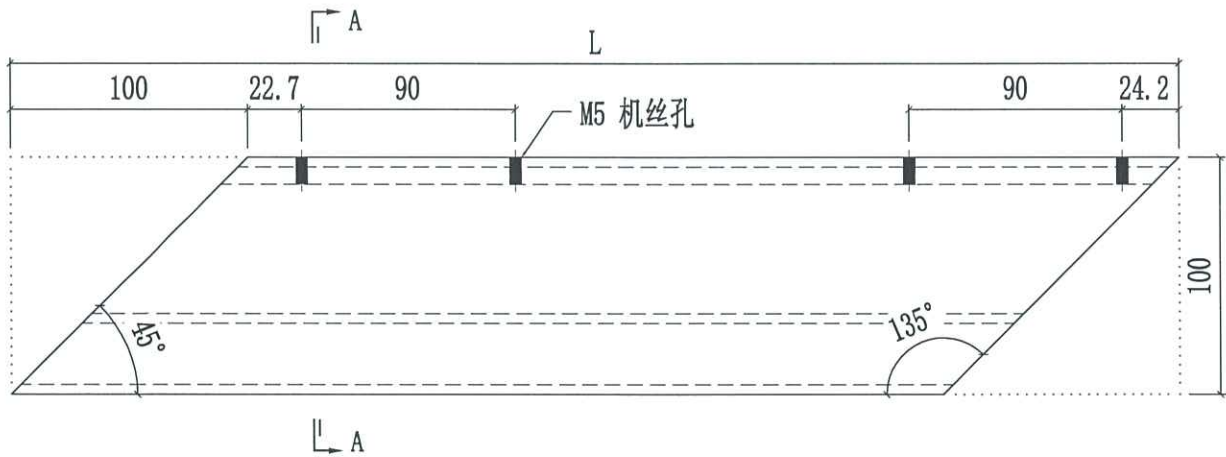

SECTION A-A



美特鋁質有限公司  
MIDI Aluminium Fabricator Ltd.

工程號	J858	類別		物料號	-		
地盘	康城11期	制圖	K. C	2023-11-23	圖號	X86361-G08	
修改日期		採用工廠	✓ 地盘	图纸名称	鋁料加工图	復核	-
		材料颜色	香槟金 (ECD3X1009 9S-XF1)	材料	X86361	批准	-
						單件重量	- (KG)

部件编号	L	数量
X86361-G08-01	1484.5	16

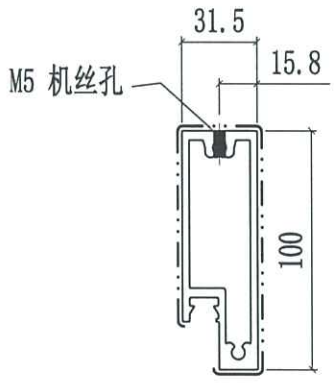
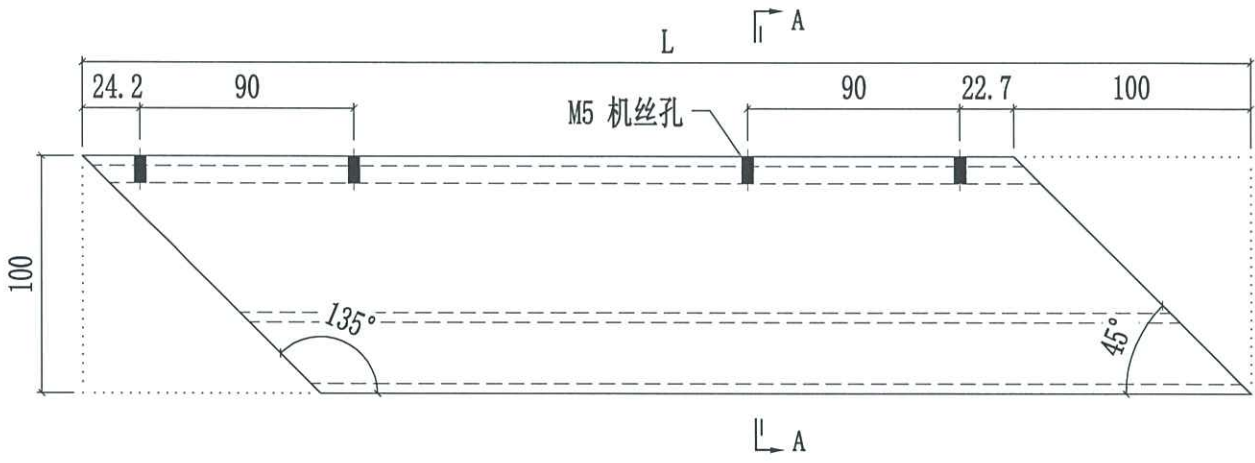

SECTION A-A



美特鋁質有限公司  
MIDI Aluminium Fabricator Ltd.

工程號	J858	類別		物料號	-							
地盘	康城11期	制圖	K. C	2023-11-23	圖號	X86362-G01						
修改		採用工廠	✓	地盤		圖紙名稱	鋁料加工圖	復核	-	-	數量	-
日期		材料顏色	香槟金 (ECD3X1009 9S-XF1)	材料	X86361	批准	-	-	單件重量	-	(KG)	

部件编号	L	数量
X86362-G01-01	1574	32
X86362-G01-02	1564	32
X86362-G01-03	1264	32
X86362-G01-04	1289	64
X86362-G01-05	1614	32
X86362-G01-06	1489	32
X86362-G01-07	1341.5	32
X86362-G01-08	1339	32

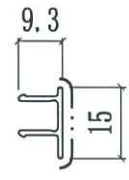
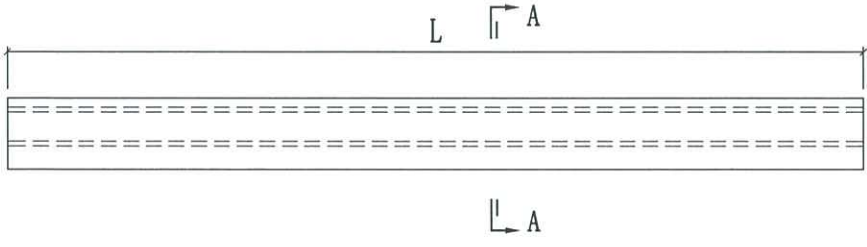

SECTION A-A



美特鋁質有限公司  
MIDI Aluminium Fabricator Ltd.

工程號	J858	類別		物料號	-							
地盘	康城11期	制圖	K. C	2023-11-23	圖號	X86362-G02						
修改		採用工廠	✓	地盤		圖紙名稱	鋁料加工圖	復核	-	-	數量	-
日期		材料顏色	香檳金 (E0D3X1009 9S-XF1)	材料	X86361	批准	-	-	單件重量	-	(KG)	

部件编号	L	数量
X86362-G02-01	1520.5	16
X86362-G02-02	708	32

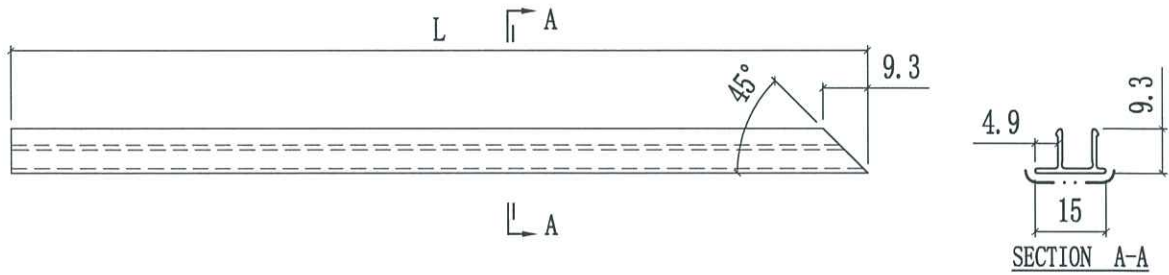



美特鋁質有限公司  
MIDI Aluminium Fabricator Ltd.

工程號	J858	類別		物料號	-							
地盘	康城11期	制圖	K. C	2023-11-23	圖號	X86362-G03						
修改		採用工廠	✓	地盤		圖紙名稱	鋁料加工圖	復核	-	-	數量	-
日期		材料顏色	香檳金 (ECD3X1009 9S-XF1)	材料	X86361	批准	-	-	單件重量	-	(KG)	

部件编号	L	数量
X86362-G03-01	610.5	16
X86362-G03-02	1547	32

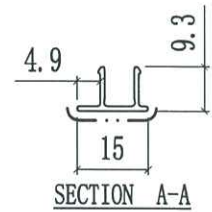
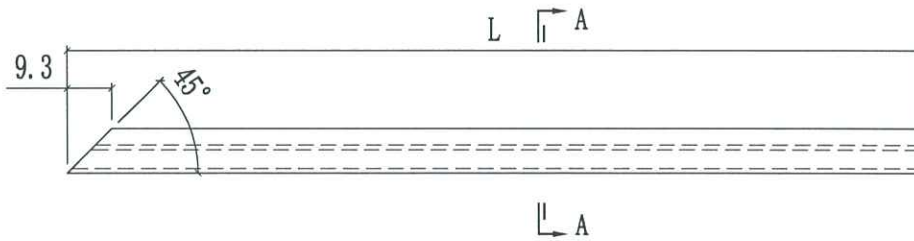



美特鋁質有限公司  
MIDI Aluminium Fabricator Ltd.

工程號	J858	類別		物料號	-						
地盘	康城11期	制圖	K. C	2023-11-23	圖號	X86362-G04					
修改		採用工廠	✓	地盤	圖紙名稱	鋁料加工圖	復核	-	-	數量	-
日期		材料顏色	香檳金 (ECD3X1009 9S-XF1)	材料	X86361	批准	-	-	單件重量	-	(KG)

部件编号	L	数量
X86362-G04-01	543.8	16

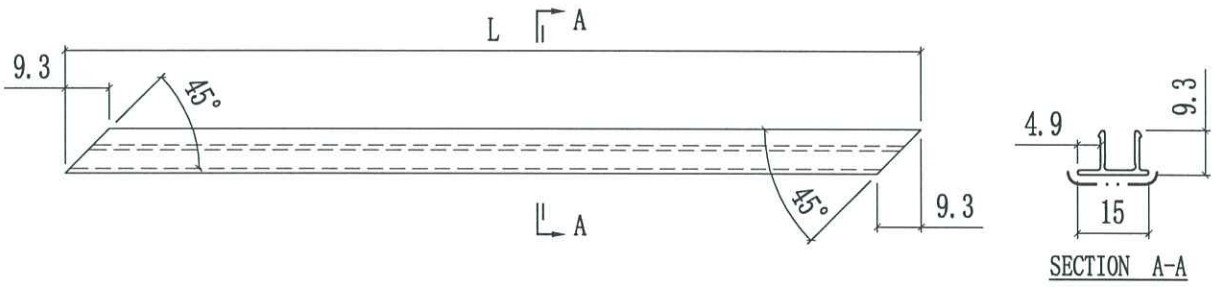



美特鋁質有限公司  
MIDI Aluminium Fabricator Ltd.

工程號	J858	類別		物料號	-							
地盘	康城11期	制圖	K. C	2023-11-23	圖號	X86362-G05						
修改		採用工廠	✓	地盤		圖紙名稱	鋁料加工圖	復核	-	-	數量	-
日期		材料顏色	香檳金 (ECC3X1009 9S-XF1)	材料	X86361	批准	-	-	單件重量	-	(KG)	

部件编号	L	数量
X86362-G05-01	1393.8	16

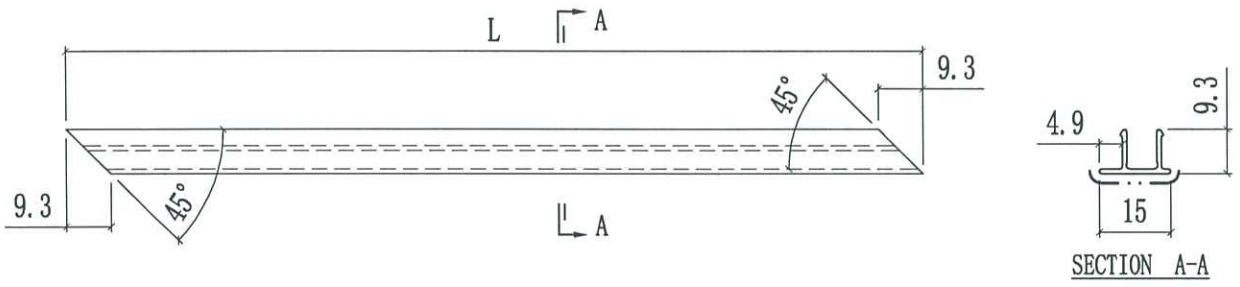

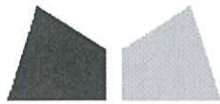

美特鋁質有限公司

MIDI ALUMINIUM FABRICATOR LTD

## 鋁材開料總表

工程號碼: J858 工程名稱: 康城11期(VO Grille)

序號	鋁料編號	名稱	表面處理		開料長度	實用長料總數量		浪費率(%)
			顏色	層厚		支數	長度	
1	X86361	格柵			4800	119	571200	2.16
2	X86362	格柵扣蓋			4800	118	566400	2.17

送至: \_\_\_\_\_

由: \_\_\_\_\_

日期: \_\_\_\_\_

簡短說明: \_\_\_\_\_

共3頁 第1頁

打印日期: 2023/11/27 打印時間: 10:18

工程號碼:J858, 工程名稱:康城11期(VO Grille)  
 開料長度:4800, 總長料支數:118, 總開料支數:416  
 鋸片厚度(mm):6, 料頭尾總切除(mm):50, 浪費率(%):2.17

**鋁材開料清單 X86362**

窗號	編號(用料狀況)	實用長度(長料開數)	需要 支數	開料 支數	長料 支數	餘料 支數	編號(剩餘長度)
X86362-G01-05	1-16	1614.0	32	32	16	0	1-16@(1510)x16
X86362-G01-01	17-27	1574.0	32	32	11	0	17-26@(10)x10 27@(1590)x1
X86362-G01-02	(餘料)27	1564.0	32	1	0	1	27@(20)x1
X86362-G01-02	28-38	1564.0		31	11	0	28-37@(40)x10
X86362-G03-02	(餘料)38	1547.0	32	2	0	1	38@(74)x1
X86362-G03-02	39-48	1547.0		30	10	0	39-48@(91)x10
X86362-G02-01	49-54	1520.5	16	16	6	0	49-53@(170.5)x5 54@(3223.5)x1
X86362-G01-06	(餘料)1-16, 54	1489.0	32	18	0	17	1-16@(15)x16 54@(233.5)x1
X86362-G01-06	55-59	1489.0		14	5	0	55-58@(265)x4 59@(1760)x1
X86362-G05-01	(餘料)59	1393.8	16	1	0	1	59@(360.2)x1
X86362-G05-01	60-64	1393.8		15	5	0	60-64@(550.6)x5
X86362-G01-07	65-75	1341.5	32	32	11	0	65-74@(707.5)x10 75@(2055)x1
X86362-G01-08	(餘料)75	1339.0	32	1	0	1	75@(710)x1
X86362-G01-08	76-86	1339.0		31	11	0	76-85@(715)x10
X86362-G01-04	(餘料)86	1289.0	64	2	0	1	86@(815)x1
X86362-G01-04	87-107	1289.0		62	21	0	87-106@(865)x20 107@(2160)x1
X86362-G01-03	(餘料)107	1264.0	32	1	0	1	107@(890)x1
X86362-G01-03	108-118	1264.0		31	11	0	108-117@(940)x10 118@(3480)x1
X86362-G02-02	(餘料)76-107	708.0	32	32	0	32	76-85@(1)x10 86@(101)x1 87-106@(151)x20 107@(176)x1
X86362-G03-01	(餘料)65-75, 108-112	610.5	16	16	0	16	65-74@(91)x10 75@(93.5)x1 108-112@(323.5)x5
X86362-G04-01	(餘料)60-64, 113-118	543.8	16	16	0	11	60-64@(0.8)x5 113-117@(390.2)x5 118@(181.2)x1

工程號碼:J858, 工程名稱:康城11期(VO Grille)  
 開料長度:4800, 總長料支數:119, 總開料支數:416  
 鋸片厚度(mm):6, 料頭尾總切除(mm):50, 浪費率(%):2.16

**鋁材開料清單 X86361**

窗號	編號(用料狀況)	實用長度(長料開數)	需要支數	開料支數	長料支數	餘料支數	編號(剩餘長度)
X86361-G01-05, X86361-G02-05	1-16	1614.0	32	32	16	0	1-16@(1510)x16
X86361-G02-01	(餘料)22	1574.0	32	2	0	1	22@(10)x1
X86361-G01-01, X86361-G02-01	17-27	1574.0		30	11	0	17-21@(10)x5 22@(3170)x1
X86361-G06-02	(餘料)27	1566.0	32	1	0	1	27@(18)x1
X86361-G06-02	28-38	1566.0		31	11	0	28-37@(34)x10
X86361-G01-02, X86361-G02-02	(餘料)38, 43	1564.0	32	3	0	2	38@(38)x1 43@(40)x1
X86361-G01-02, X86361-G04-01	39-48	1564.0		29	10	0	39-42@(40)x4
X86361-G04-01	49-54	1539.5	16	16	6	0	49-53@(113.5)x5 54@(3204.5)x1
X86361-G01-06, X86361-G02-06	(餘料)1-16, 54	1489.0	32	18	0	17	1-16@(15)x16 54@(214.5)x1
X86361-G02-06	55-59	1489.0		14	5	0	55-58@(265)x4 59@(1760)x1
X86361-G08-01	(餘料)59	1484.5	16	1	0	1	59@(269.5)x1
X86361-G08-01	60-64	1484.5		15	5	0	60-64@(278.5)x5
X86361-G01-07	65-75	1341.5	32	32	11	0	65-74@(707.5)x10 75@(2055)x1
X86361-G03-01	(餘料)75	1339.0	32	1	0	1	75@(710)x1
X86361-G03-01	76-86	1339.0		31	11	0	76-85@(715)x10 86@(3405)x1
X86361-G01-04	(餘料)86	1289.0	64	2	0	1	86@(815)x1
X86361-G01-04, X86361-G02-04	87-107	1289.0		62	21	0	87-106@(865)x20 107@(2160)x1
X86361-G01-03	(餘料)107	1264.0	32	1	0	1	107@(890)x1
X86361-G01-03, X86361-G02-03	108-118	1264.0		31	11	0	108-117@(940)x10 118@(3480)x1
X86361-G05-01	(餘料)86-117	727.0	32	32	0	32	86@(82)x1 87-106@(132)x20 107@(157)x1 108-117@(207)x10
X86361-G07-01	(餘料)65-80	634.5	16	16	0	16	65-74@(67)x10 75@(69.5)x1 76-80@(74.5)x5
X86361-G06-01	(餘料)81-85, 118	629.5	16	10	0	6	81-85@(79.5)x5 118@(302.5)x1
X86361-G06-01	119	629.5		6	1	0	119@(937)x1