

工程指示 / 要求簡箋 ENGINEER INSTRUCTIONS(E.I.)

工程指示編號:	EI- 6005	修改版本:	A
	HK-0774		
工程編號:	J 853	工程名稱:	延坪道
收件人:	生統	發件人:	Joe Chan
工程項目:	Podium Ceiling Feature TT天花地盤用鋁板(第2批)	日期:	19/04/2023

<input checked="" type="checkbox"/> 原合約工程包	<input type="checkbox"/> 原合約工程加 / 減賬 QT-	<input type="checkbox"/> 新工程報價 QT-
--------------------------------------------	------------------------------------------	------------------------------------

信件批核號碼/圖紙參考編號:	批核模具圖紙編號:
客戶指示附件:	管理內部批簽署:

<input type="checkbox"/> 初步鋁料 B.M.	<input type="checkbox"/> 加工拆圖, 然後生產	<input type="checkbox"/> 尺寸表
<input type="checkbox"/> 正式鋁料 B.M.	<input type="checkbox"/> 技術上資料/指示	<input type="checkbox"/> 報價
<input type="checkbox"/> 配件 B.M.	<input type="checkbox"/> 樣辦或貨品說明書	<input type="checkbox"/> 分判合約
<input type="checkbox"/> 其他:		

內容: 修改A: 補充圖紙標示.  
請替換此版本EI之更新圖紙, 生產該批鋁板.

完成上列要求日期: ASAP

國內

<input type="checkbox"/> 生產技術總監	<input type="checkbox"/> 連附件	<input type="checkbox"/> 技術部	<input type="checkbox"/> 連附件	<input type="checkbox"/> 生產部	<input type="checkbox"/> 連附件
<input type="checkbox"/> 採購部	<input type="checkbox"/> 連附件	<input checked="" type="checkbox"/> 生產統籌部	<input checked="" type="checkbox"/> 連附件	<input type="checkbox"/> 報關組	<input type="checkbox"/> 連附件
<input type="checkbox"/> 質檢部	<input type="checkbox"/> 連附件	<input type="checkbox"/> 會計部	<input type="checkbox"/> 連附件	<input type="checkbox"/> 機械設計部	<input type="checkbox"/> 連附件
<input type="checkbox"/> 香港辦	<input type="checkbox"/> 連附件	<input type="checkbox"/> 其他:			

香港

<input type="checkbox"/> 行政部	<input type="checkbox"/> 連附件	<input type="checkbox"/> 會計部	<input type="checkbox"/> 連附件	<input type="checkbox"/> 統籌部	<input type="checkbox"/> 連附件	<input type="checkbox"/> 工程部	<input type="checkbox"/> 連附件
<input type="checkbox"/> 採購部	<input type="checkbox"/> 連附件	<input type="checkbox"/> QS部	<input type="checkbox"/> 連附件	<input checked="" type="checkbox"/> 地盤管理	<input checked="" type="checkbox"/> 連附件	<input type="checkbox"/> 維修部	<input type="checkbox"/> 連附件

*發件人簽署:	<i>JC</i>	*組別成員批核簽署:	<i>P.P. JC</i>
傳遞編號:	HK0774/23	項目經理簽署:	<i>P.P. JC</i>

REV.	CHECKED DATE BY	PART NUMBER	Dim. A	Dim. B	Dim. C	Dim. D	Dim. E	Dim. F	Dim. G	QTY	Inv. Code	EXTR. DRAWING PART DRAWING
-		T7-CE02-01-01								11		

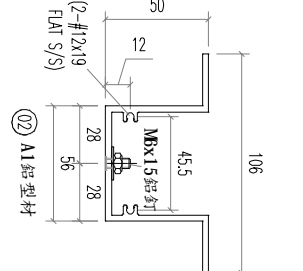
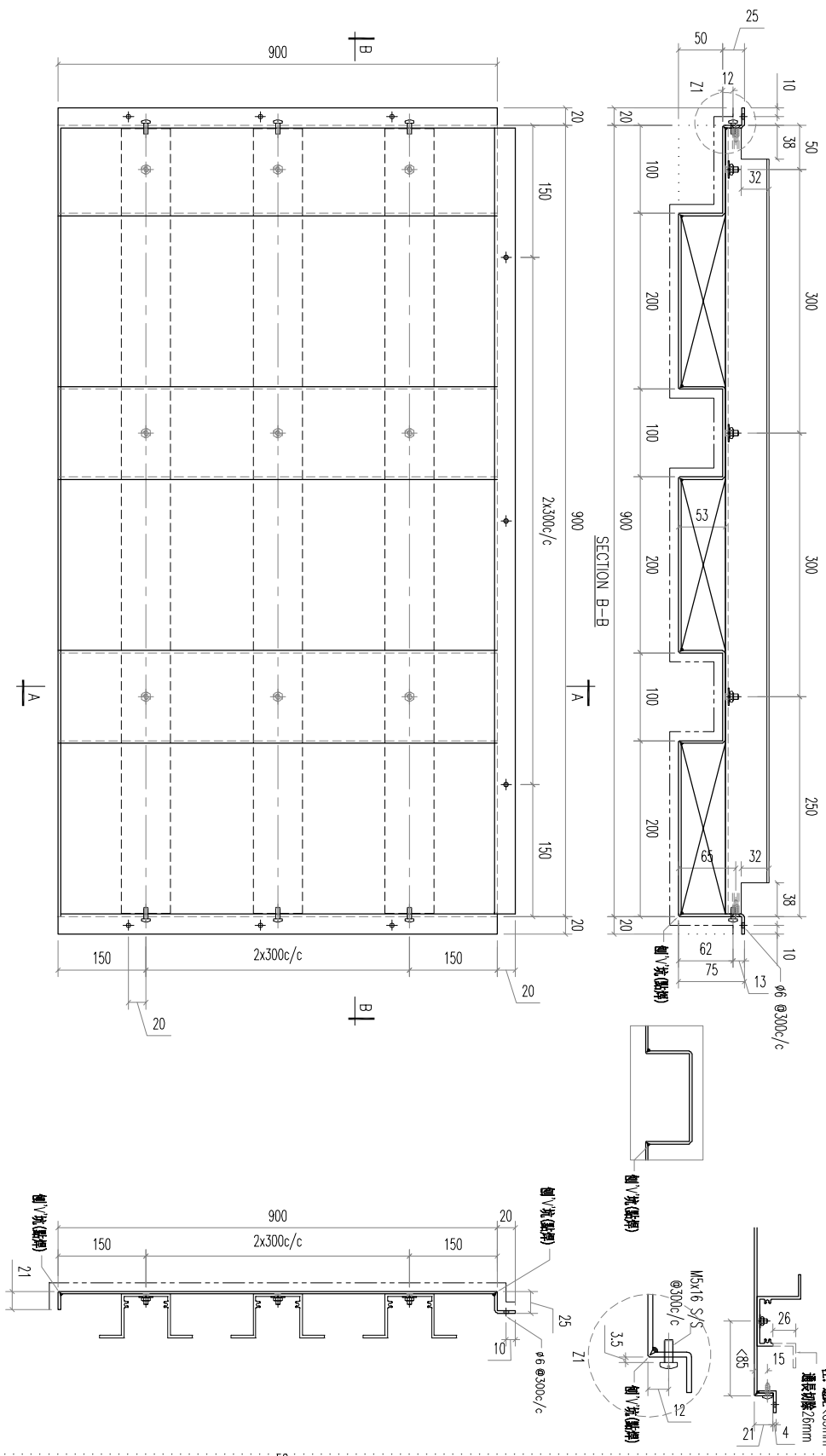

02	A1 鋁型材	893	開料	3	
REV	材料規格	長度	配件描述	數量	备注

**美特鋁質有限公司**  
MIDI ALUMINIUM FABRICATOR LTD.  
Units 6-8, Sunroy Industrial Centre, 1/F  
610 Cho Kwo Ling Road, Kowloon  
Tel:23489211-4 Fax:(852)2727666

PROJECT	J853-PODIUM ALUM CEILING & FEATURE CLADDING T7 7/F	JOB NO.	J853
FACTORY	01	W/CENTRE	W/CENTRE/SKID/FAB
Standard	X X . = ±1	CUT ENDS	Angle ±1°
Tolerances	X X . X = ±05	DATE	4/19/2023
	Squareness ±1°	DRAWN	YEUNG
		SCALE	1:5
		POST PAINT	PART
		PRE PAINT	SUB ASSEM.
		SCALE	1:5
		TRACK TYPE	S.....

DRAWING TITLE	鋁板天花加工圖 3mm THK. ALUM PLATE	DRAWING NO.	T7-CE02-01-01
FINISH	EC-DG-0334232-201 (AL1)	噴漆	
DATE	4/19/2023		
FINISH	EC-DG-0334232-201 (AL1)		
DATE	4/19/2023		
FINISH	EC-DG-0334232-201 (AL1)		
DATE	4/19/2023		

REV	DATE	AMENDMENT	REVISED BY







REV.	CHECKED DATE	PART NUMBER	Dim. A	Dim. B	Dim. C	Dim. D	Dim. E	Dim. F	Dim. G	QTY	Inv. Code	ASSEMBLE ON PARTS	EXTR. DRAWING PART DRAWING
-		T7-CE02-05-01								1			

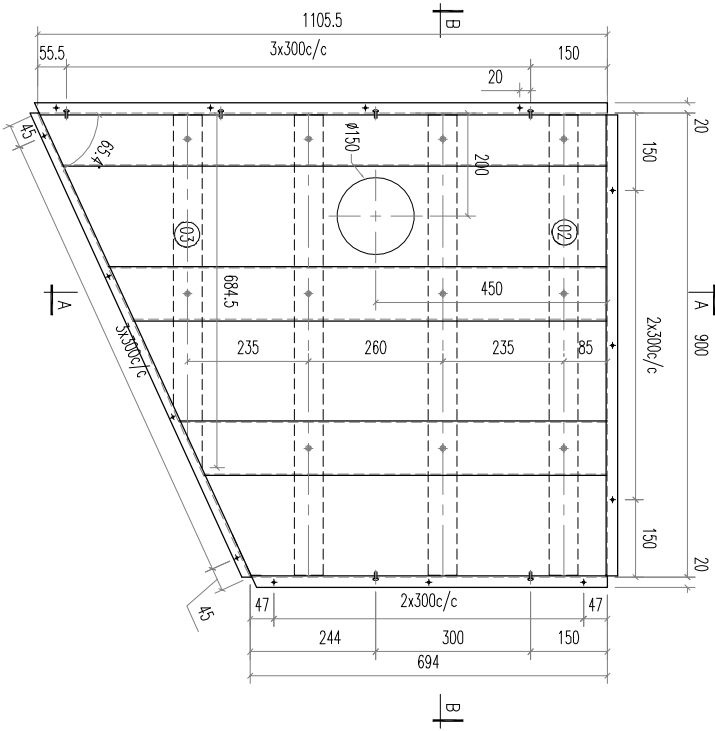
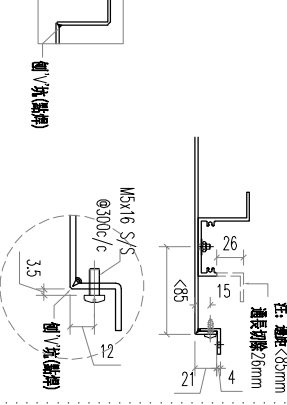
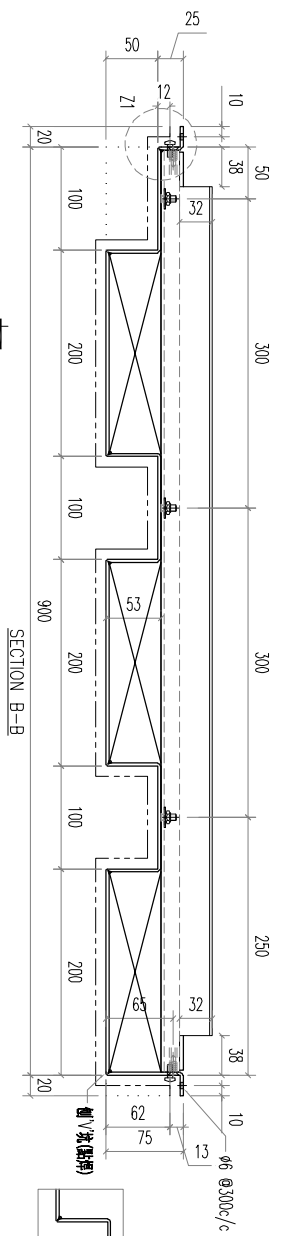

SECTION A-A

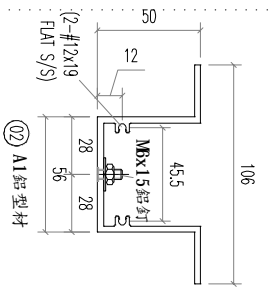

REV.	DATE	AMENDMENT	REVISED BY
03		A1 鋁型材	
02		A1 鋁型材	
		材料規格	長度
		開料	數量
		零件描述	備註

**美特鋁質有限公司**  
MIDI ALUMINIUM FABRICATOR LTD.

Units 6-8, Sunroy Industrial Centre,  
610 Cho Kwo Ling Road, Kowloon  
Tel:23489211-4 Fax:(852)27727666

PROJECT J853-PODIUM ALUM CEILING  
& FEATURE CLADDING T7 7/F

JOB NO. J853

FACTORY	W/CENTRE	CUT ENDS	FINISH
01	MAX/SCBA/FAB		EC-DG-0334232-201 (A1)
Standard	X X . = ±1	Angle	DATE
Tolerances	X X . X = ±05	Squareness ±1'	4/19/2023

DRAWING TITLE  
鋁板天花加工圖  
3mm THK. ALUM PLATE

DRAWING NO.	SCALE	POST PAINT	PART
T7-CE02-05-01	1:5	PRE PAINT	SUB ASSEM.
		SCALE	TRACK TYPE
			S.....
		SHT.	REV.
		-/-	-



REV.	CHECKED BY	PART NUMBER	Dim. A	Dim. B	Dim. C	Dim. D	Dim. E	Dim. F	Dim. G	QTY	Inv. Code	ASSEMBLE ON PARTS	EXTR. DRAWING PART DRAWING
-		T7-CE02-07-01								1			

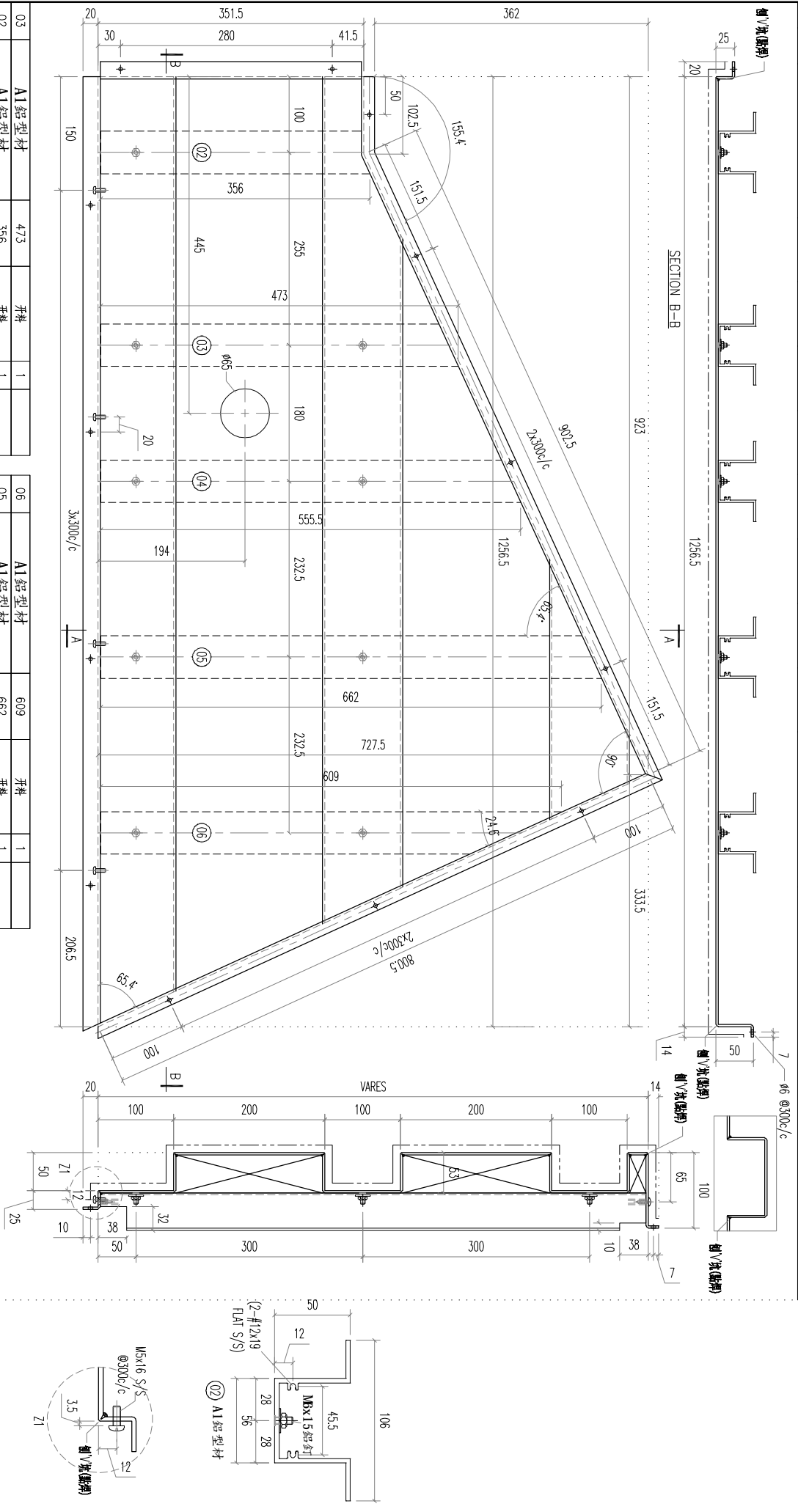

REV.	DATE	AMENDMENT	REVISED BY	PROJECT	JOB NO.	DRAWING TITLE	DRAWING NO.	SHT.	REV.
03		A1鋁型材		<b>美特鋁質有限公司</b> <b>MIDI ALUMINIUM FABRICATOR LTD.</b> Units 6-8, Sunroy Industrial Centre, 1/F 610 Cho Kwo Ling Road, Kowloon Tel:23489211-4 Fax:(852)2727666	J853	鋁板天花加工圖	T7-CE02-07-01	-	-
02		A1鋁型材			J853	3mm THK. ALUM PLATE		-	-
		材料規格							
		長度							
		配件描述							
		數量							
		備註							
06		A1鋁型材							
05		A1鋁型材							
04		A1鋁型材							

REV.	CHECKED BAR BY	PART NUMBER	Dim. A	Dim. B	Dim. C	Dim. D	Dim. E	Dim. F	Dim. G	QTY	Inv. Code	ASSEMBLE ON PARTS	EXTR. DRAWING PART DRAWING
-		T7-CE02-08-01								2			

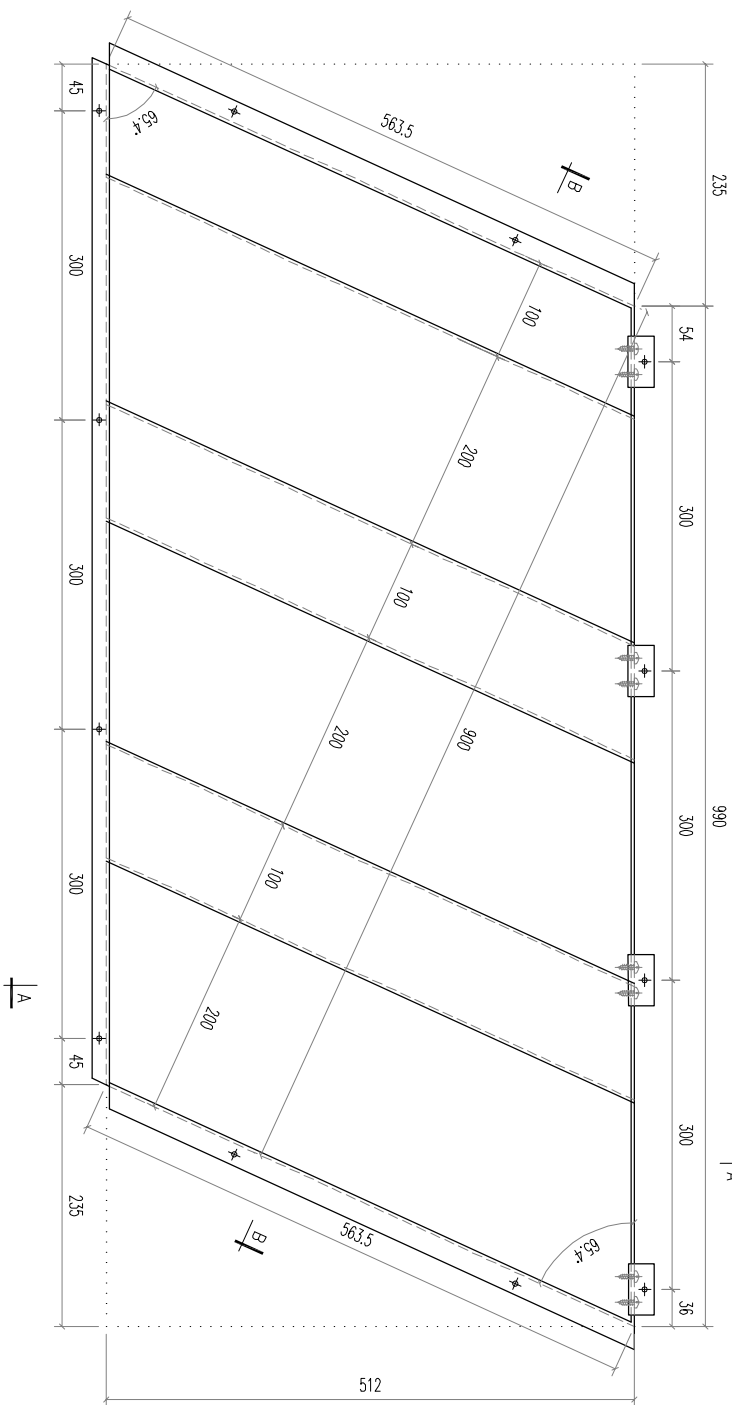
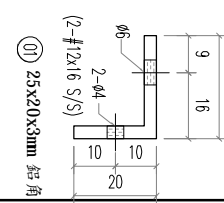
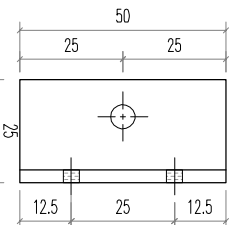
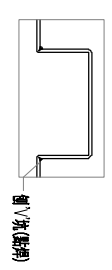
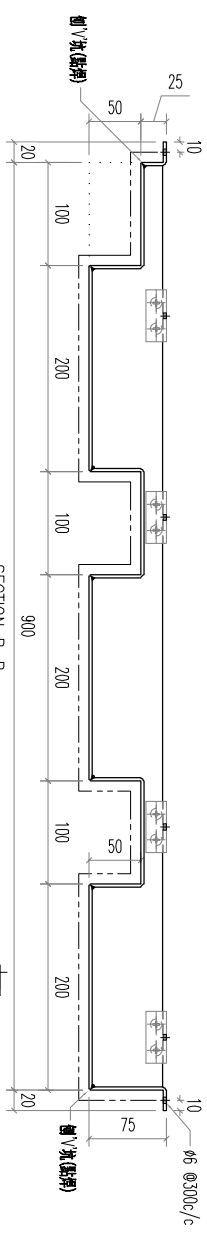

SECTION A-A

01	25x20x3mm 铝角	50	开料	4	
序号	材料规格	长度	配件描述	数量	备注

**美特铝质有限公司**  
MIDI ALUMINIUM FABRICATOR LTD.  
Units 6-8, Sunroy Industrial Centre, 1/F  
610 Cho Kwo Ling Road, Kowloon  
Tel: 23489211-4 Fax: (852) 27727666

REV.	DATE	AMENDMENT	REVISED BY	PROJECT	JOB NO.	DRAWING TITLE	DRAWING NO.	SHT.	REV.
				J853-PODIUM ALUM CEILING & FEATURE CLADDING T7 7/F	J853	铝板天花加工图 3mm THK. ALUM PLATE	T7-CE02-08-01	-/-	-

REV.	CHECKED	PART NUMBER	Dim. A	Dim. B	Dim. C	Dim. D	Dim. E	Dim. F	Dim. G	QTY	Inv. Code	ASSEMBLE ON PARTS	EXTR. DRAWING
—	BAR BY	T7-CE02-09-01								9			PART DRAWING

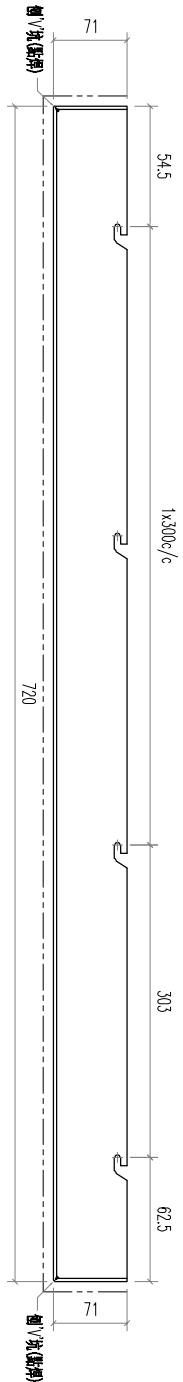

SECTION B-B

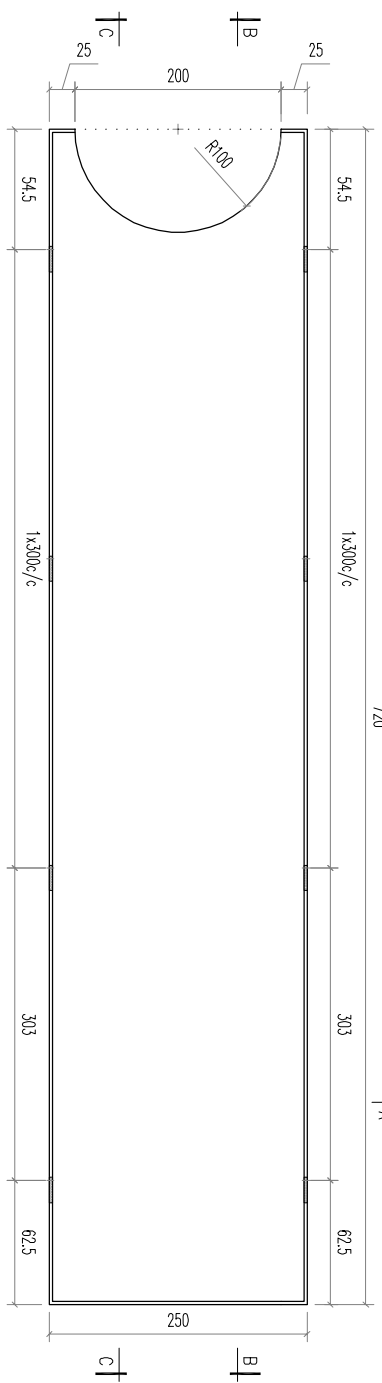

SECTION A-A

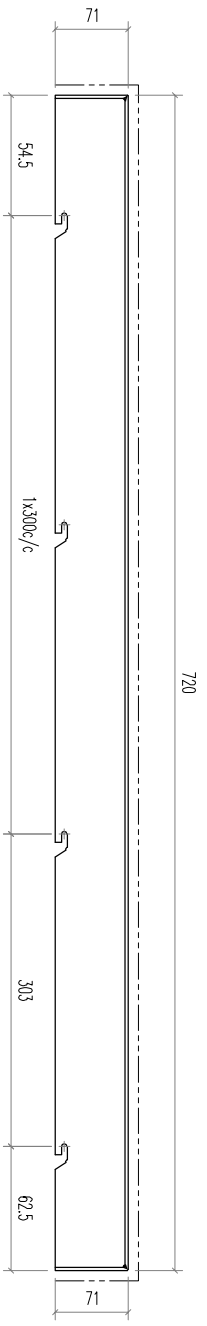

SECTION C-C

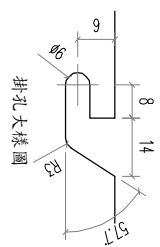

**美特鋁質有限公司**  
MIDI ALUMINIUM FABRICATOR LTD.  
Units 6-8, Sunroy Industrial Centre, 1/F  
610 Cho Kwo Ling Road, Kowloon  
Tel: 23489211-4 Fax: (852) 2727666

PROJECT J853-PODIUM ALUM CEILING  
& FEATURE CLADDING T7 7/F  
JOB NO. J853

FACTORY	W/CENTRE	CUT ENDS	FINISH
01	MARK/SKID/FAB		

Standard	DATE	DRAWN	POST PAINT	PART
Tolerances X X . X = ±1	4/19/2023	YEUNG	SCALE 1:5	SUB ASSEM.
Angle Squereness ±1'				TRACK TYPE S.....

DRAWING TITLE	DRAWING NO.	SHT.	REV.
鋁板天花加工圖 3mm THK. ALUM PLATE	T7-CE02-09-01	-/-	-

REV.	DATE	AMENDMENT	REVISED BY
------	------	-----------	------------

REV.	CHECKED DATE BY	PART NUMBER	Dim. A	Dim. B	Dim. C	Dim. D	Dim. E	Dim. F	Dim. G	QTY	Inv. Code	ASSEMBLE ON PARTS	EXTR. DRAWING PART DRAWING
-		T7-CE02-01-02								14			

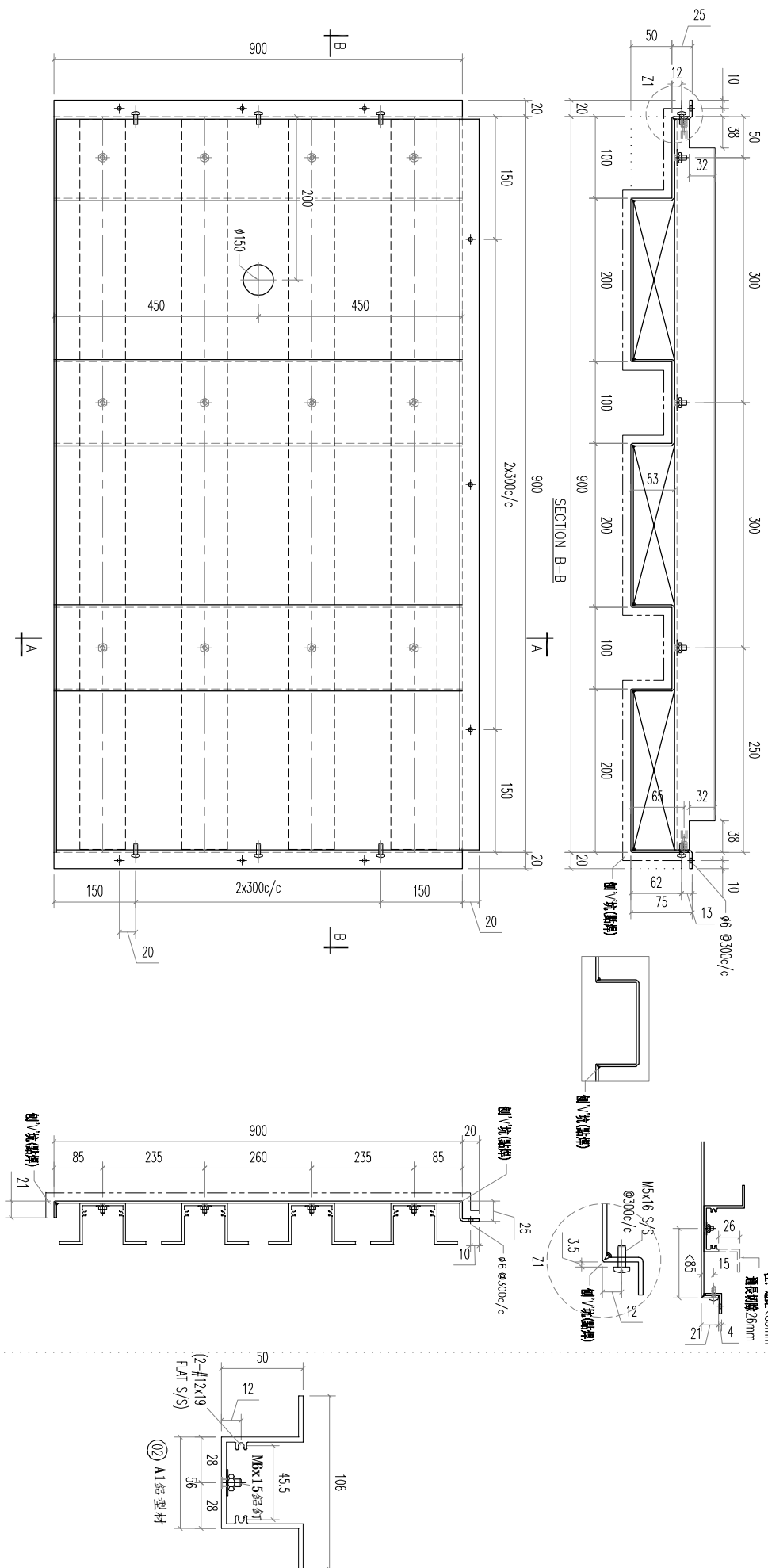

02	A1 铝型材	893	开料	4	
REV.	材料规格	长度	配件描述	数量	备注
REV.	DATE	AMENDMENT	REVISED BY		
<p><b>美特铝质有限公司</b> MIDI ALUMINIUM FABRICATOR LTD. Units 6-8, Sunray Industrial Centre, 1/F 610 Cho Kwo Ling Road, Kowloon Tel:23489211-4 Fax:(852)27727666</p> <p>PROJECT J853-PODIUM ALUM CEILING &amp; FEATURE CLADDING T7 7/F</p> <p>JOB NO. J853</p> <p>FACTORY 01 W/CENTRE MBX/F/SKBA/FAB CUT ENDS Standard X X . X = ±1 Angle ±1' DATE 4/19/2023 Tolerances X X . X = ±05 Squareness ±1'</p> <p>DRAWING TITLE 铝板天花加工图 3mm THK. ALUM PLATE</p> <p>DRAWING NO. T7-CE02-01-02</p> <p>POST PAINT PRE PAINT SCALE 1:5 PART SUB ASSEM. TRACK TYPE S.....</p>					

REV.	CHECKED DATE BY	PART NUMBER	Dim. A	Dim. B	Dim. C	Dim. D	Dim. E	Dim. F	Dim. G	QTY	Inv. Code	ASSEMBLE ON PARTS	EXTR. DRAWING PART DRAWING
-		T7-CE02-02-02								1			

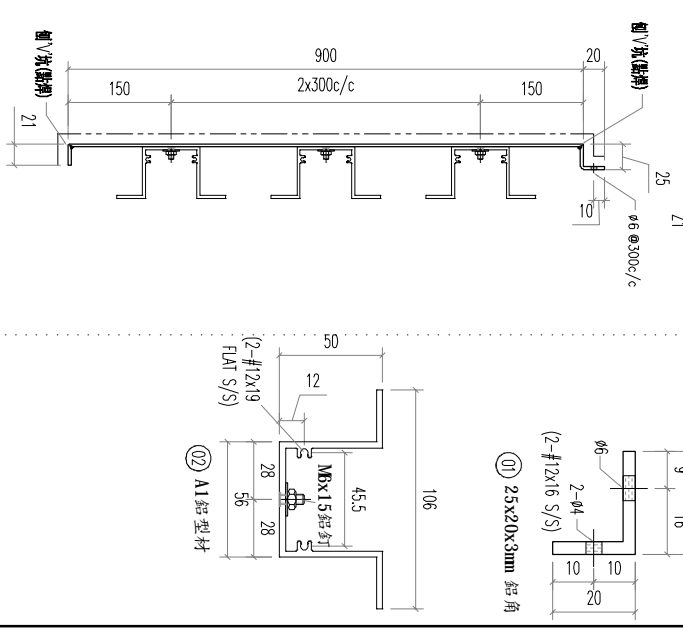
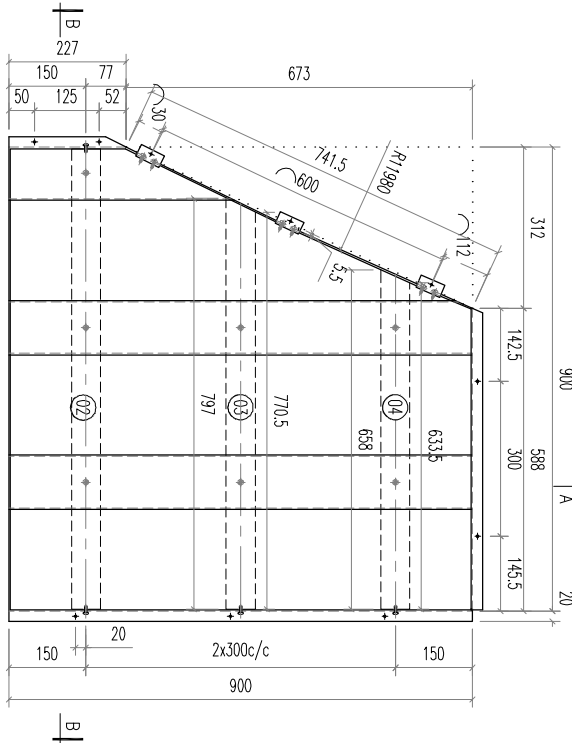
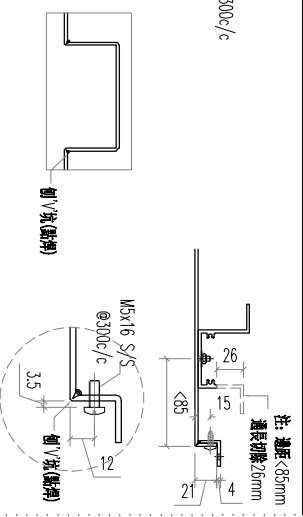
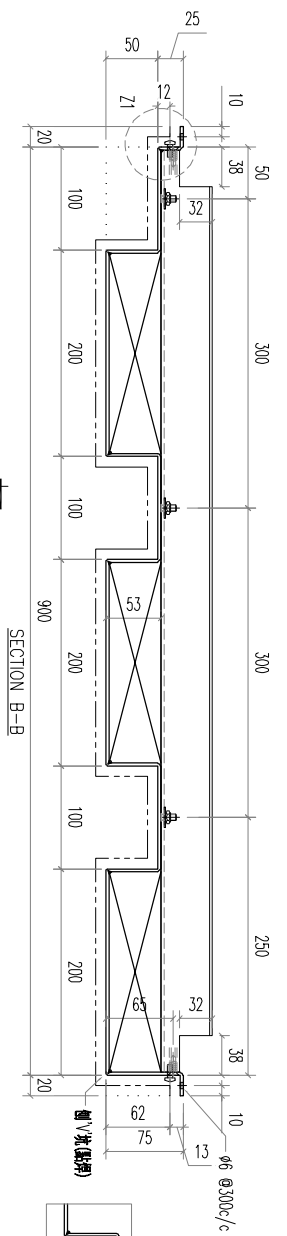

REV.	DATE	AMENDMENT	REVISED BY
04		A1鋁型材	658
03		A1鋁型材	797
02		A1鋁型材	893
01		2.5X20X3mm 鋁角	50
		材料規格	長度
			配件描述
			數量
			备注

**美特鋁質有限公司**  
MIDI ALUMINIUM FABRICATOR LTD.  
Units 6-8, Sunroy Industrial Centre, 1/F  
610 Cha Kwo Ling Road, Kowloon  
Tel:23489211-4 Fax:(852)27727666

PROJECT	J853-PODIUM ALUM CEILING & FEATURE CLADDING T7 7/F	JOB NO.	J853	DRAWING TITLE	鋁板天花加工圖 3mm THK. ALUM PLATE	DRAWING NO.	T7-CE02-02-02	POST PAINT	PRE PAINT	SCALE	1:5	PART	SUB ASSEM.	TRACK TYPE	S.....	SHT.	-/-	REV.	-
FACTORY	01	W/CENTRE	MAX/SCA/FAB	CUT ENDS	ANGLE	DATE	4/19/2023	FINISH	EC-DG-0334232-201 (AL1)	DRAWN	YEUNG	噴漆							
Standard	X X .	= ±1	Angle	±1°	DATE	4/19/2023													
Tolerances	X X . X = ±05	Squareness	±1°																

REV.	CHECKED	PART NUMBER	Dim. A	Dim. B	Dim. C	Dim. D	Dim. E	Dim. F	Dim. G	QTY	Inv. Code	ASSEMBLE ON PARTS	EXTR. DRAWING
1	BAR BY	T7-CE02-03-02								1			PART DRAWING

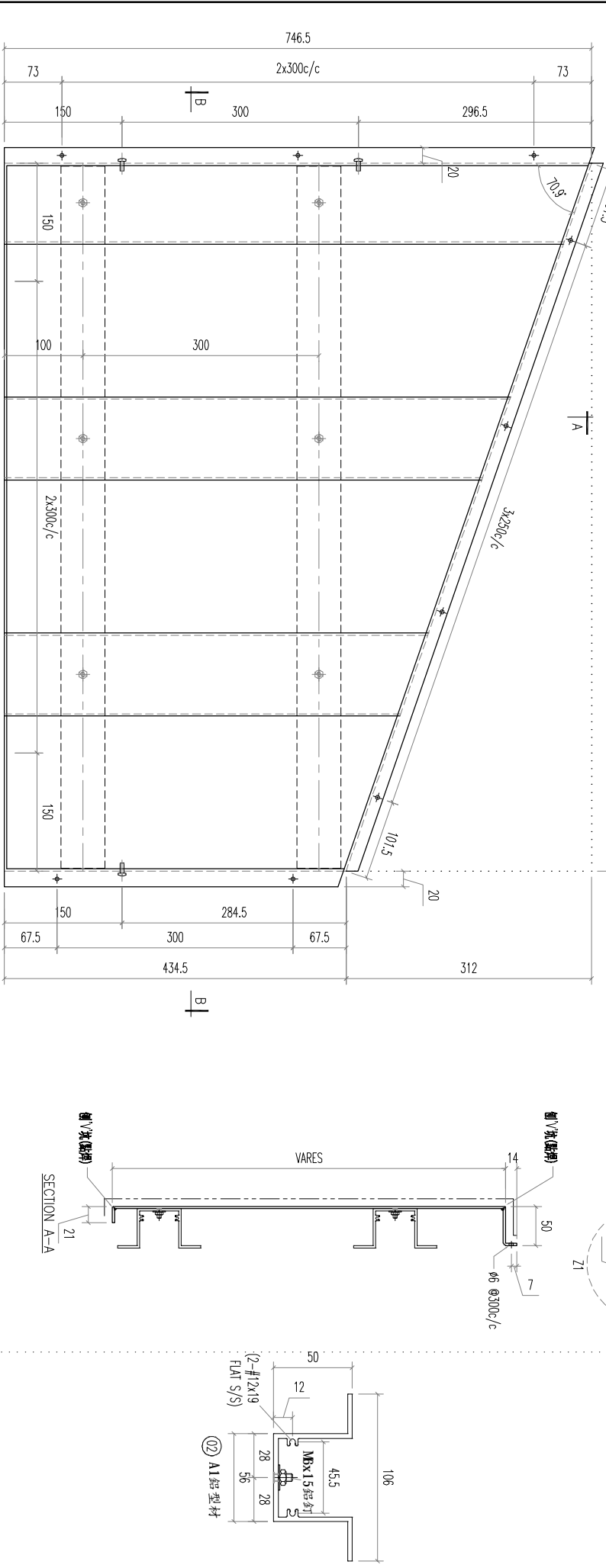
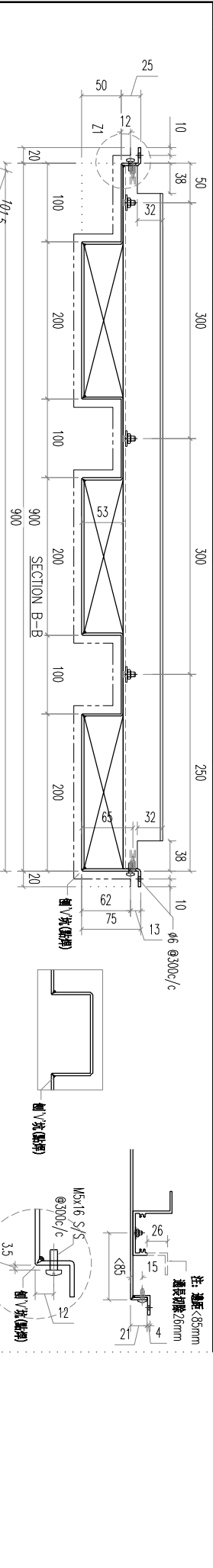

02	A1 鋁型材	893	開料	2	
序號	材料規格	長度	配件描述	數量	備註

FACTORY	W/CENTRE	CUT ENDS	FINISH	DATE	DRAWN	SCALE	POST PAINT	PART	TRACK TYPE
01	MAX8/SK8A/FAB	Angle	EC-DG-0334232-Z01 (AL1)	4/19/2023	YEUNG	1:5	PRE PAINT	MBX15 鋁釘	S.....

美特鋁質有限公司  
MIDI ALUMINIUM FABRICATOR LTD.  
Units 6-8, Sunray Industrial Centre, 1/F  
610 Cha Kwo Ling Road, Kowloon  
Tel:23489211-4 Fax:(852)2727666

REV.	DATE	AMENDMENT	REVISED BY	PROJECT	JOB NO.	DRAWING TITLE	DRAWING NO.	SHT.	REV.
				J853-PODIUM ALUM CEILING & FEATURE CLADDING T7 7/F	J853	鋁板天花加工圖 3mm THK. ALUM PLATE	T7-CE02-03-02	-/-	-

REV.	CHECKED BY	PART NUMBER	Dim. A	Dim. B	Dim. C	Dim. D	Dim. E	Dim. F	Dim. G	QTY	Inv. Code	ASSEMBLE ON PARTS	EXTR. DRAWING PART DRAWING
-		T7-CE02-04-02								1			

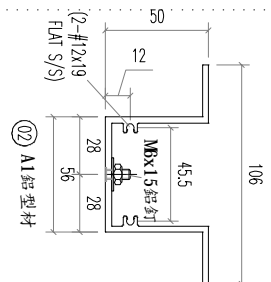
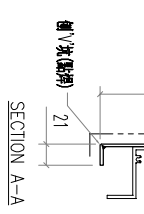
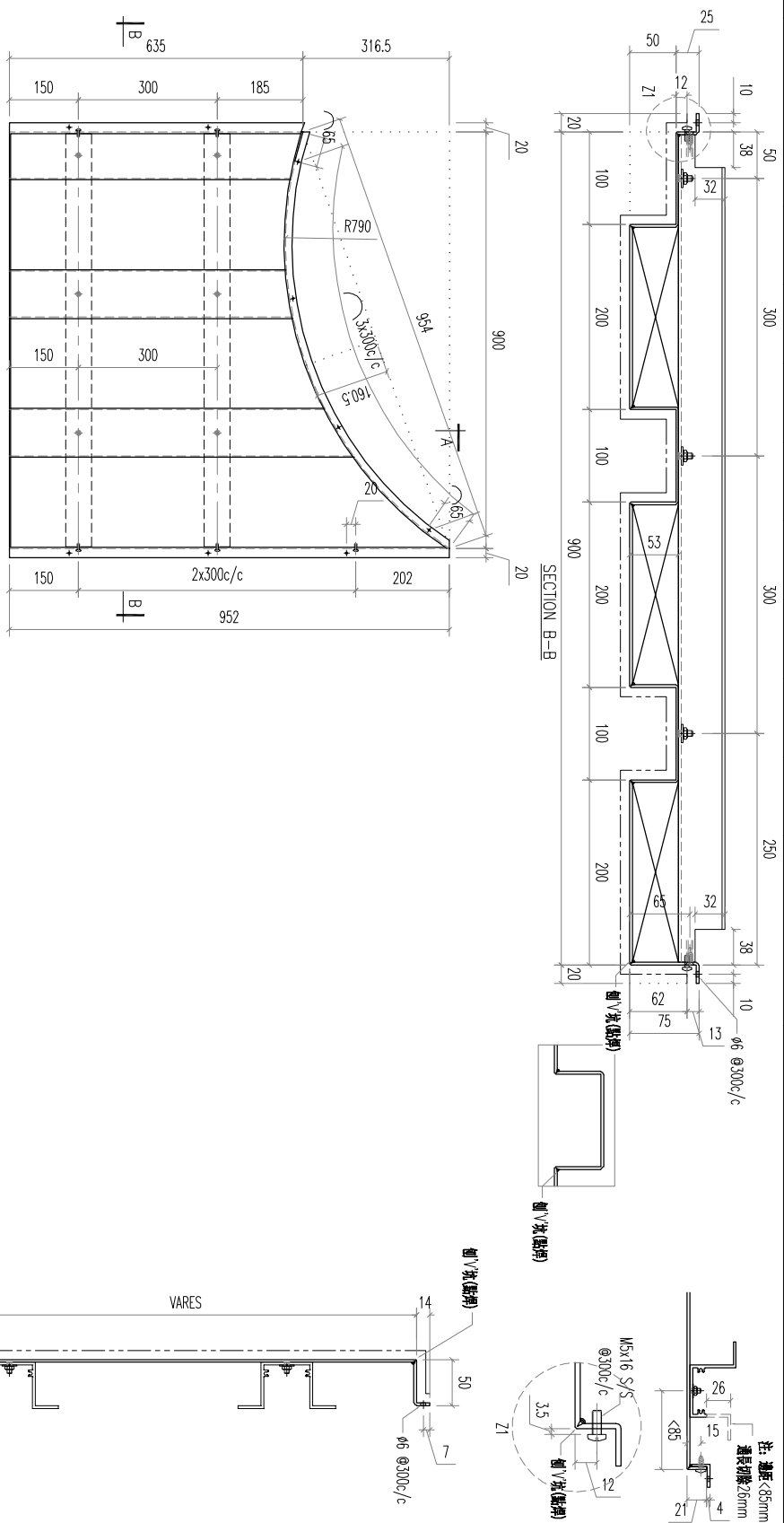

02	A1 鋁型材	893	開料	2	
REV	材料規格	長度	配件描述	數量	备注
REV	DATE	AMENDMENT	REVISED BY		
<p> <b>美特鋁質有限公司</b>  <b>MIDI ALUMINIUM FABRICATOR LTD.</b>          Units 6-8, Sunray Industrial Centre, 1/F          610 Cho Kwo Ling Road, Kowloon          Tel:23489211-4 Fax:(852)27727666       </p> <p>         PROJECT J853-PODIUM ALUM CEILING &amp; FEATURE CLADDING T7 7/F          JOB NO. J853       </p> <p>         FACTORY 01 W/CENTRE WCKX/SKBA/FAB CUT ENDS Standard X X . = ±1 Angle ±1' DATE 4/19/2023          Tolerances X X . X = ±05 Squariness ±1'       </p> <p>         DRAWING TITLE 鋁板天花加工圖 3mm THK. ALUM PLATE          DRAWING NO. T7-CE02-04-02          DRAWMN YEUNG          POST PAINT PRE PAINT SCALE 1:5          PART SUB ASSEM. TRACK TYPE S....          SHT. -/- REV. -       </p>					

REV.	CHECKED	PART NUMBER	Dim. A	Dim. B	Dim. C	Dim. D	Dim. E	Dim. F	Dim. G	QTY	Inv. Code	ASSEMBLE ON PARTS	EXTR. DRAWING
1	BAR BY	T7-CE02-05-02								1			PART DRAWING

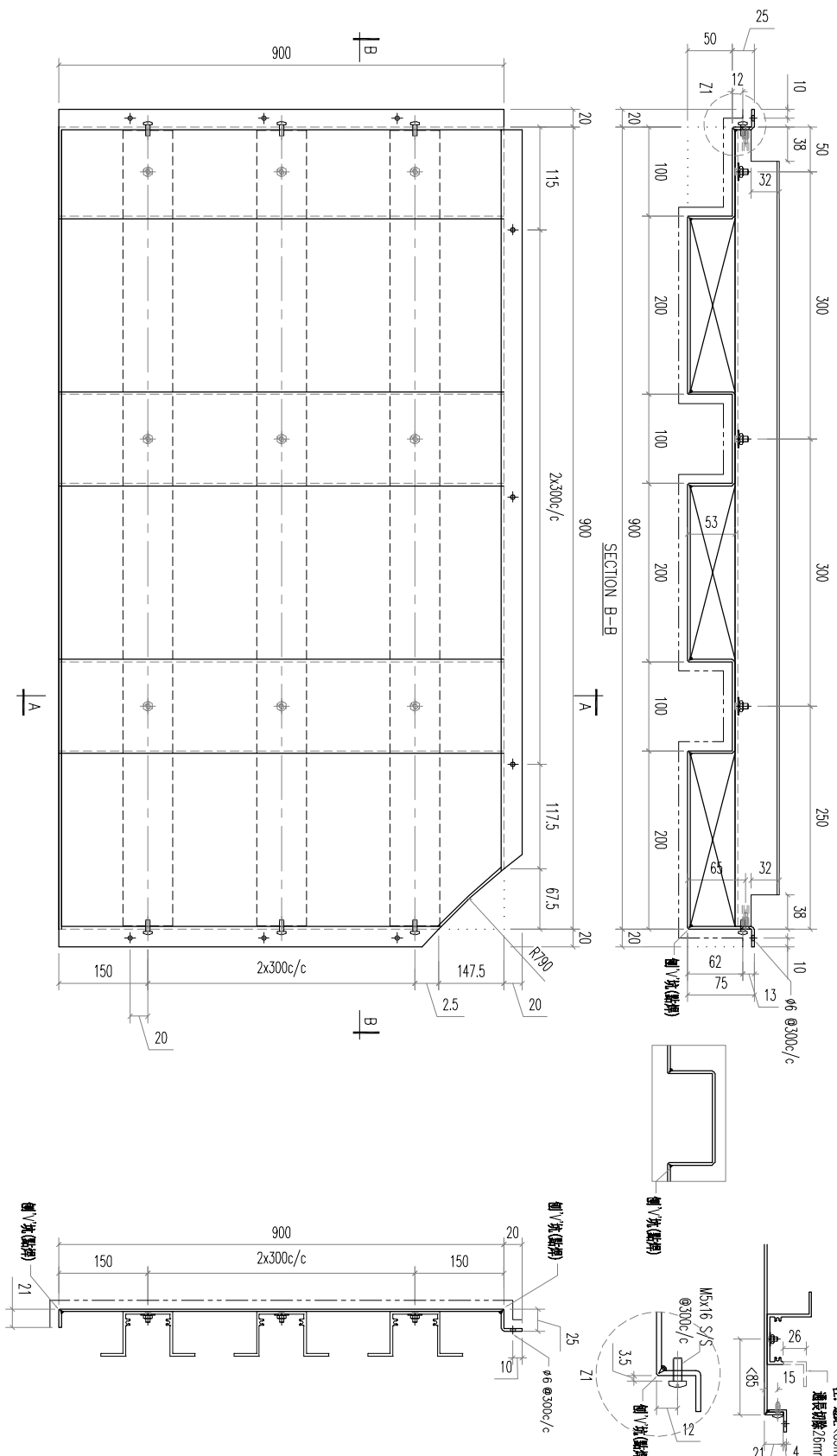

SECTION A-A

SECTION B-B

SECTION C-C

SECTION D-D

SECTION E-E

SECTION F-F

02	A1 鋁型材	893	開料	3	
REV.	材料規格	長度	配件描述	數量	备注
DATE					
AMENDMENT					
REVISED BY					

**美特鋁質有限公司**  
**MIDI ALUMINIUM FABRICATOR LTD.**  
 Units 6-8, Sunroy Industrial Centre, Kowloon  
 610 Cho Kwo Ling Road, Kowloon  
 Tel:23489211-4 Fax:(852)2727666

PROJECT **J853-PODIUM ALUM CEILING**  
**& FEATURE CLADDING T7 7/F**

JOB NO. **J853**

FACTORY	W/CENTRE	CUT ENDS	FINISH	DATE
01	W/CENTRE / S/DIA / FAB	±1	EC-DG-0334232-201 (AL1)	4/19/2023
Standard	X X . X = ±1	Angle		
Tolerances	X X . X = ±05	Squareness ±1°		
DRAWING TITLE	鋁板天花加工圖			
	3mm THK. ALUM PLATE			
DRAWING NO.	T7-CE02-05-02			

DRAWING NO.	T7-CE02-05-02
SCALE	1:5
POST PAINT	<input type="checkbox"/>
PRE PAINT	<input checked="" type="checkbox"/>
PART	<input checked="" type="checkbox"/>
SUB ASSEM.	<input type="checkbox"/>
TRACK TYPE	S.....
SHT.	-/-
REV.	-

REV.	CHECKED BY	PART NUMBER	Dim. A	Dim. B	Dim. C	Dim. D	Dim. E	Dim. F	Dim. G	QTY	Inv. Code	ASSEMBLE ON PARTS	EXTR. PART DRAWING
-		T7-CE02-06-02								1			

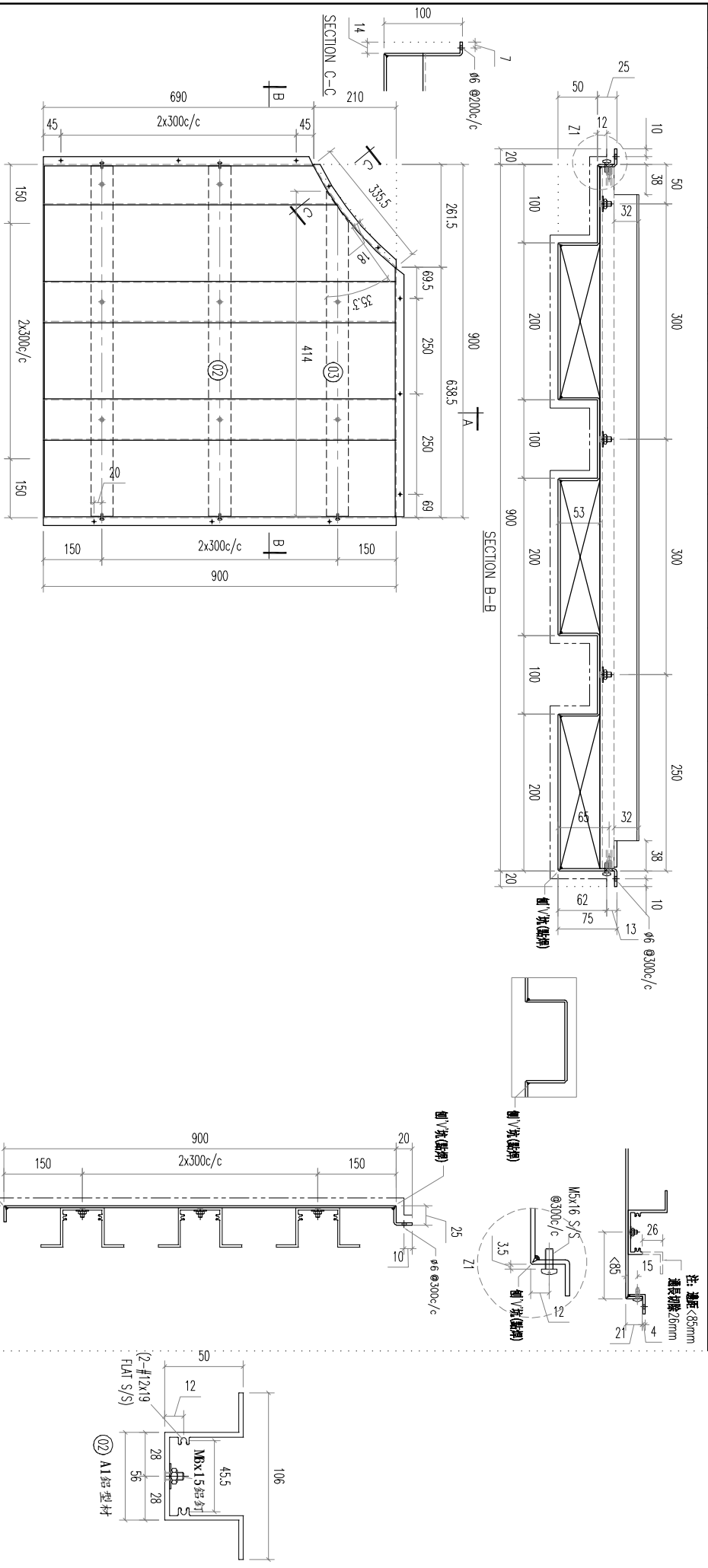

REV	DATE	AMENDMENT	REVISED BY	REVISION
03		A1 鋁型材		1
02		A1 鋁型材		2
		材料規格	長度	開料
			配件描述	數量
				备注

**美特鋁質有限公司**  
MIDI ALUMINIUM FABRICATOR LTD.  
Units 6-8, Sunroy Industrial Centre, 1/F  
610 Cho Kwo Ling Road, Kowloon  
Tel: 23489211-4 Fax: (852) 27727666

PROJECT: J853-PODIUM ALUM CEILING & FEATURE CLADDING T7 7/F

JOB NO. J853

FACTORY 01  
W/CENTRE MBX8/SK8A/FAB  
CUT ENDS  
FINISH EC-06-0334232-201 (A1)  
DATE 4/19/2023  
DRAWN YEUNG  
SCALE 1:5

Standard X X . X = ±1  
Tolerances X X . X = ±05  
Angle Squareness ±1°

3mm THK. ALUM PLATE

DRAWING TITLE

DRAWING NO. T7-CE02-06-02

POST PAINT PRE PAINT

PART SUB ASSEM.

SHT. REV.

REV.	CHECKED DATE	PART NUMBER	Dim. A	Dim. B	Dim. C	Dim. D	Dim. E	Dim. F	Dim. G	QTY	Inv. Code	EXTR. DRAWING PART DRAWING
-		T7-CE02-07-02								1		

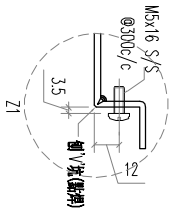
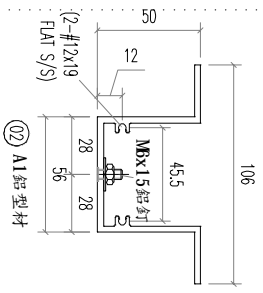
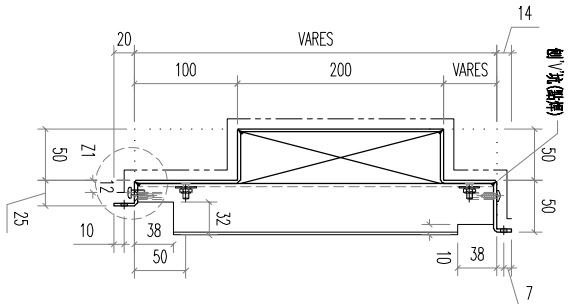
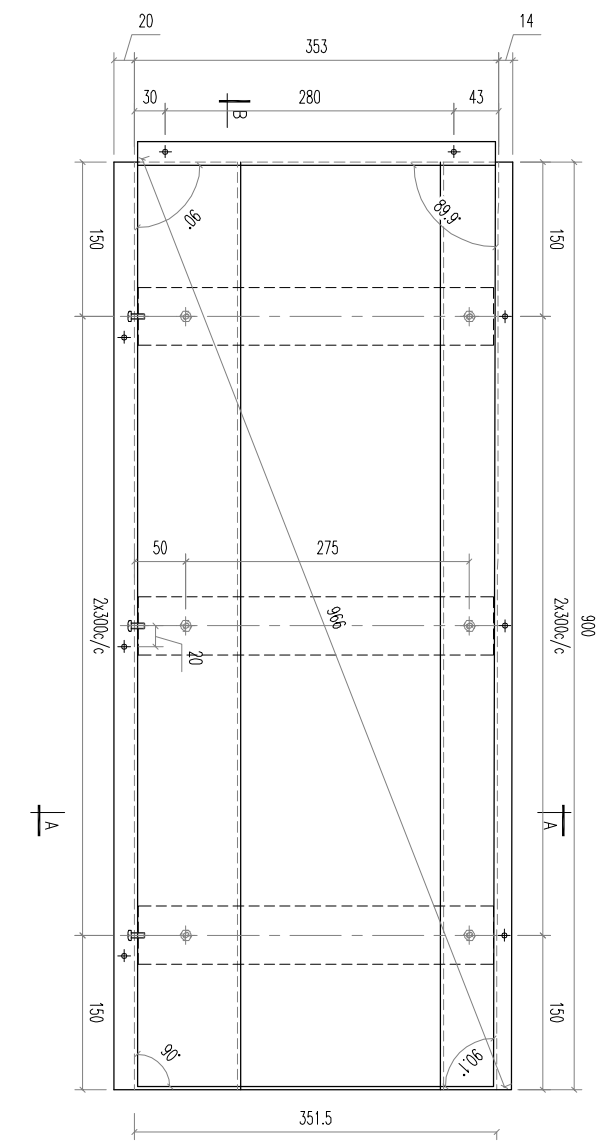
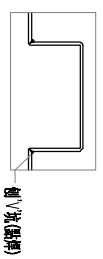
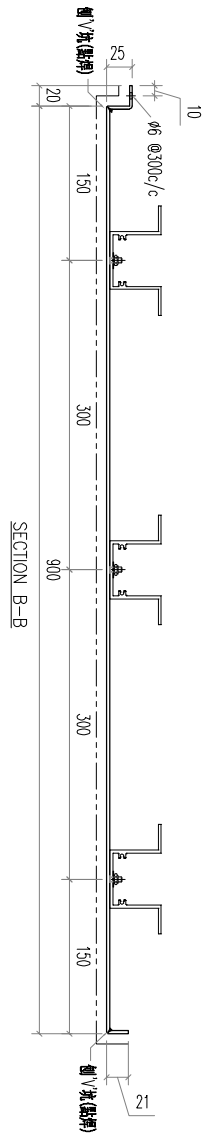

REV.	DATE	AMENDMENT	REVISED BY	REVISION	REVISION	REVISION	REVISION	REVISION	REVISION	REVISION	REVISION	REVISION
02		A1鋁型材	345	3	3	3	3	3	3	3	3	3
REV.	DATE	AMENDMENT	REVISED BY	REVISION	REVISION	REVISION	REVISION	REVISION	REVISION	REVISION	REVISION	REVISION
材料規格		長度	開料	數量	備註							
A1鋁型材		345	開料	3								
MIDI ALUMINIUM FABRICATOR LTD.		美特鋁質有限公司 610 Cha Kwo Ling Road, Kowloon Tel:23489211-4 Fax:(852)27727666										
PROJECT		J853-PODIUM ALUM CEILING & FEATURE CLADDING T7 7/F										
JOB NO.		J853										
FACTORY		01										
W/CENTRE		MCKK/SKBA/FAB										
CUT ENDS		Angle										
FINISH		EC-DG-0334232-201 (AL1)										
DATE		4/19/2023										
DRAWING TITLE		鋁板天花加工圖										
DRAWING NO.		T7-CE02-07-02										
POST PAINT		PRE PAINT										
SCALE		1:5										
PART		SUB ASSEM.										
SHT.		-/-										
REV.		-										



REV.	CHECKED	PART NUMBER	Dim. A	Dim. B	Dim. C	Dim. D	Dim. E	Dim. F	Dim. G	QTY	Inv. Code	ASSEMBLE ON PARTS	EXTR. DRAWING
—	BAR BY	T7-CE02-09-02								19			PART DRAWING

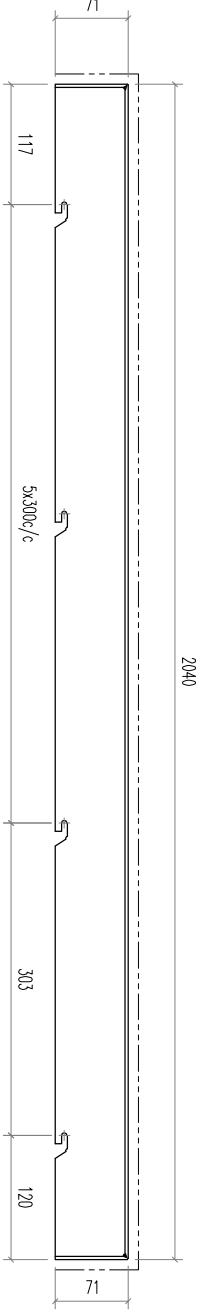
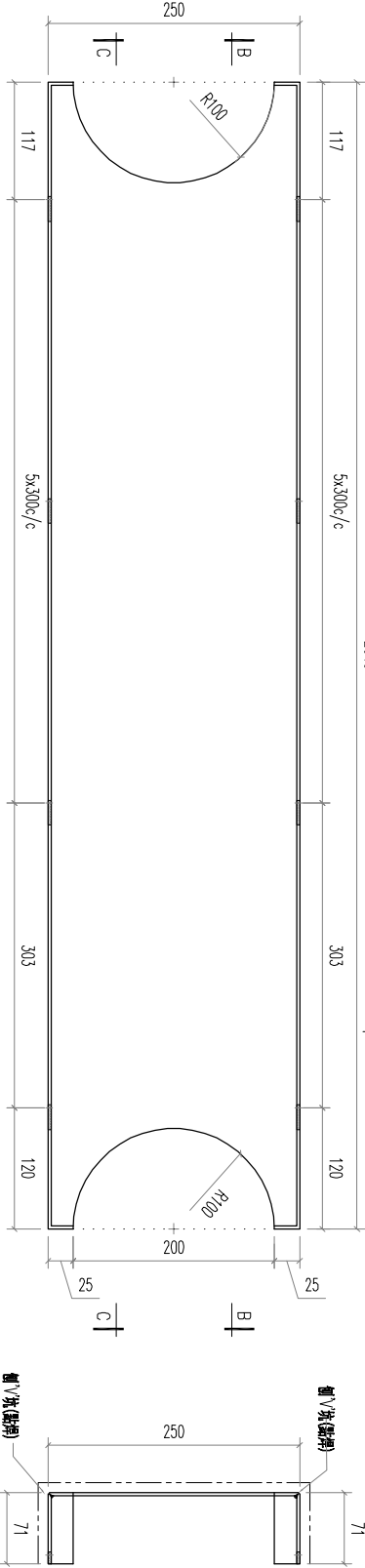
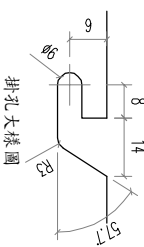
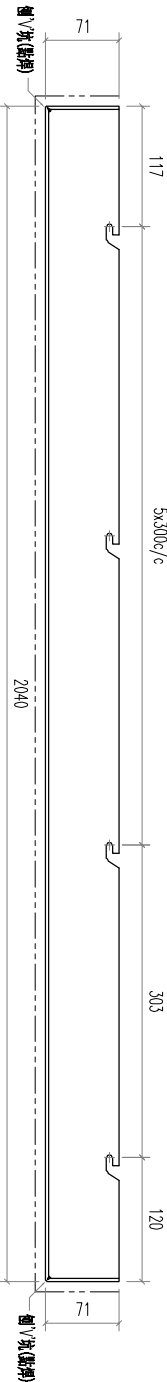

REV.	DATE	AMENDMENT	REVISED BY	PROJECT	JOB NO.	DRAWING TITLE	DRAWING NO.	SHT.	REV.
				美特鋁質有限公司 MIDI ALUMINIUM FABRICATOR LTD. Units 6-8, Sunroy Industrial Centre, 1/F 610 Cho Kwo Ling Road, Kowloon Tel:23489211-4 Fax:(852)27727666	J853	鋁板天花加工圖 3mm THK. ALUM. PLATE	T7-CE02-09-02	-/-	-
				FACTORY 01	W/CENTRE	CUT ENDS	FINISH		
				Standard	XXXX = ±1	Angle	4/19/2023		
				Tolerances	XXXX = ±05	Squareness ±1'			
				POST PAINT	SCALE	PART			
				1:5	1:5	TRACK TYPE			
				S.....					

REV.	CHECKED	PART NUMBER	Dim. A	Dim. B	Dim. C	Dim. D	Dim. E	Dim. F	Dim. G	QTY	Inv. Code	ASSEMBLE ON PARTS	EXTR. DRAWING
1	BAR BY	T7-CE02-01-03								2			PART DRAWING

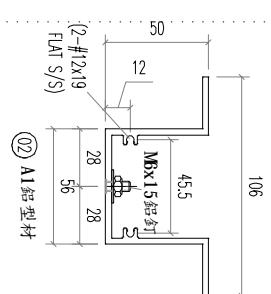
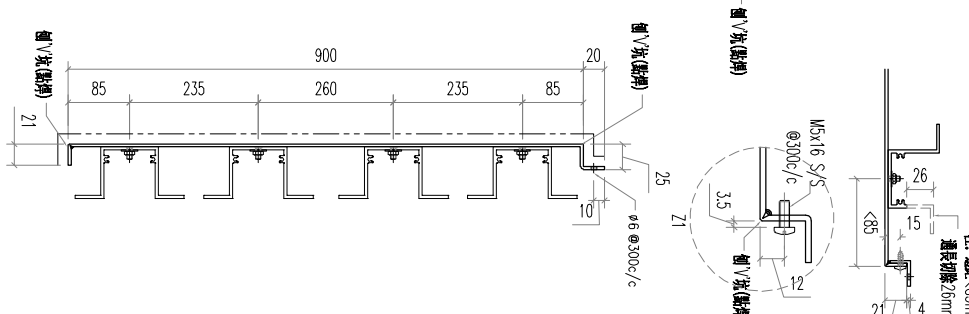
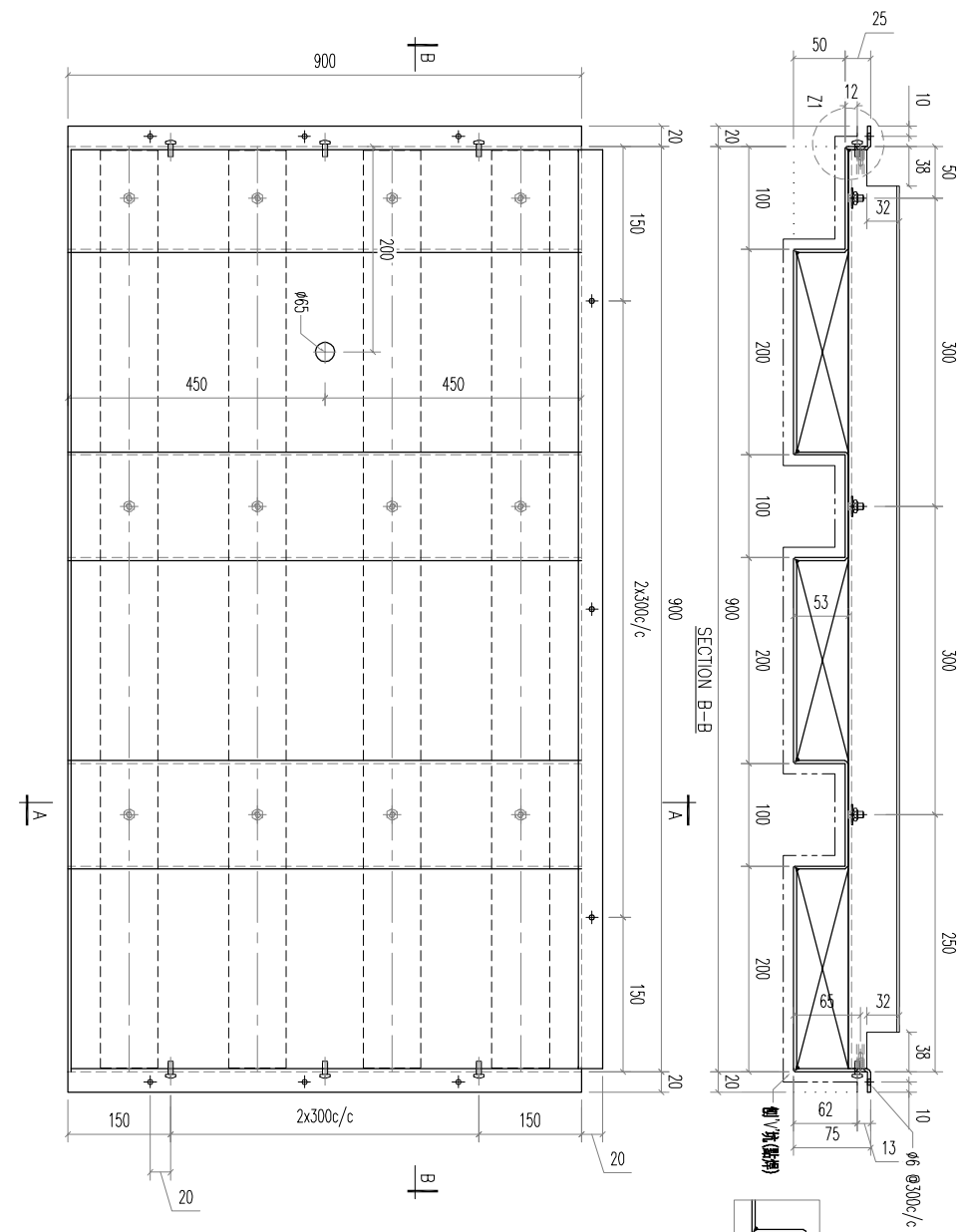

注: 溝底 <85mm  
連接距離 20mm

SECTION A-A

02	A1 鋁型材	893	開料	4	
序號	材料規格	長度	配件描述	數量	备注

**美特鋁質有限公司**  
MIDI ALUMINIUM FABRICATOR LTD.

Units 6-8, Sunroy Industrial Centre, 1/F  
610 Cho Kwo Ling Road, Kowloon  
Tel: 23489211-4 Fax: (852) 27727666

PROJECT J853-PODIUM ALUM CEILING  
& FEATURE CLADDING T7 7/F

JOB NO. J853

FACTORY	W/CENTRE	CUT ENDS	FINISH	DATE
01	MAX/SCA/FAB		EC-DG-0334232-201 (A1)	4/19/2023
Standard	X X . X = ±1	Angle		
Tolerances	X X . X = ±05	Squareness ±1°		

DRAWING TITLE  
鋁板天花加工圖  
3mm THK. ALUM PLATE

DRAWING NO.	T7-CE02-01-03
POST PAINT	PART
SCALE	1:5
SHT.	-/-

REV.	CHECKED DATE BY	PART NUMBER	Dim. A	Dim. B	Dim. C	Dim. D	Dim. E	Dim. F	Dim. G	QTY	Inv. Code	ASSEMBLE ON PARTS	EXTR. DRAWING PART DRAWING
-		T7-CE02-02-03								1			

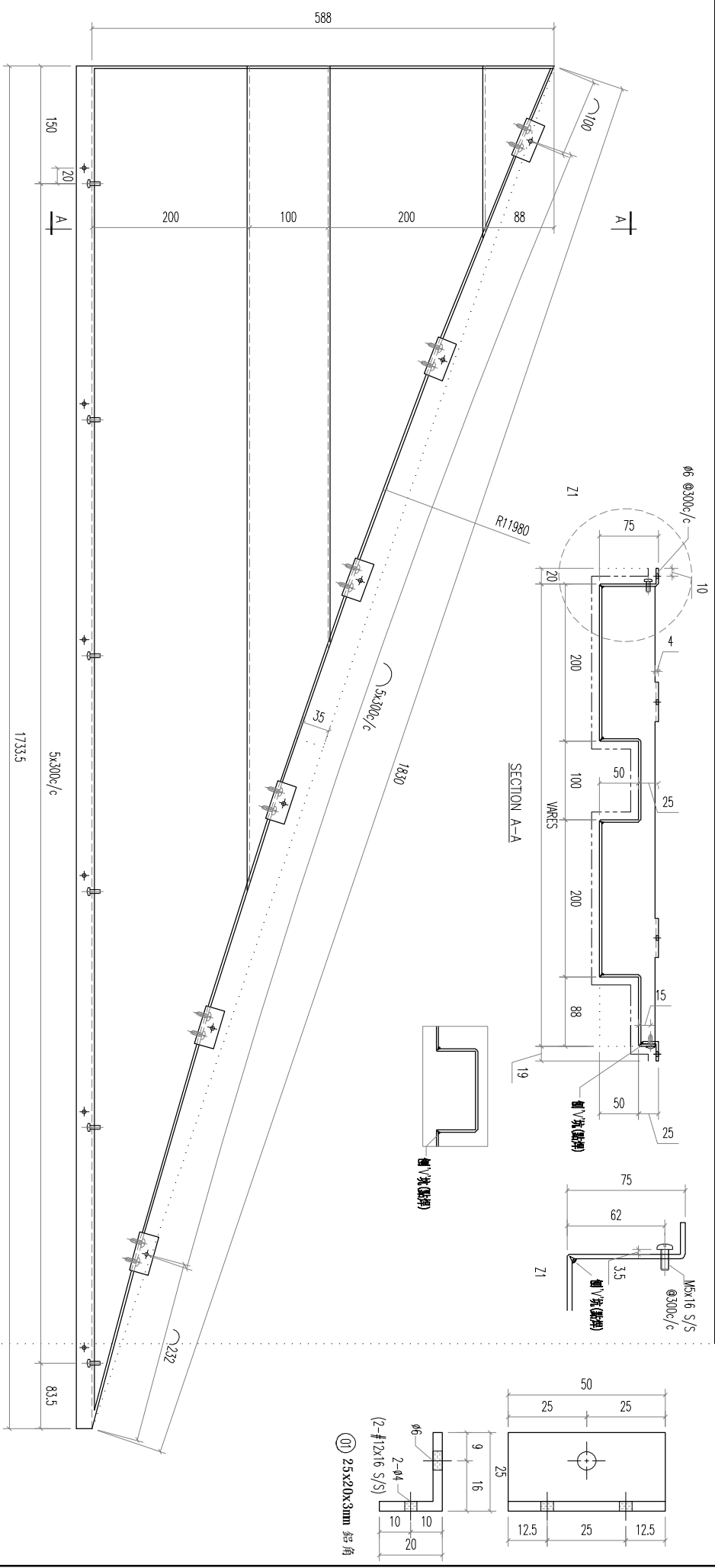

01	25x20x3mm 鋁角	50	開料	6	
REV.	DATE	AMENDMENT	REVISED BY	備註	
<p>材料規格</p> <p>長度</p> <p>配件描述</p> <p>數量</p>					
<p>UNITED ALUMINIUM FABRICATOR LTD.</p> <p>美特鋁質有限公司</p> <p>Units 6-8, Sunroy Industrial Centre, 1/F</p> <p>610 Cha Kwo Ling Road, Kowloon</p> <p>Tel:23489211-4 Fax:(852)2727666</p>					
PROJECT J853-PODIUM ALUM CEILING & FEATURE CLADDING T7 7/F			JOB NO. J853		
DRAWING TITLE			DRAWING NO.		
3mm THK. ALUM PLATE			T7-CE02-02-03		
FACTORY 01		W/CENTRE MARK/SCBA/FAB	CUT ENDS	FINISH	DATE
Standard X X . = ±1		Angle Squareness ±1°	±1°	EC-DG-0334232-201 (AL1)	4/19/2023
Tolerances X X . X = ±05				DRAWN YEUNG	SCALE 1:5
POST PAINT		PART	SHT.	REV.	
PRE PAINT		SUB ASSEM.	-/-	-	
SCALE 1:5		TRACK TYPE	S.....		

REV.	CHECKED DATE BY	PART NUMBER	Dim. A	Dim. B	Dim. C	Dim. D	Dim. E	Dim. F	Dim. G	QTY	Inv. Code	ASSEMBLE ON PARTS	EXTR. DRAWING PART DRAWING
-		T7-CE02-03-03								1			

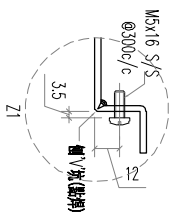
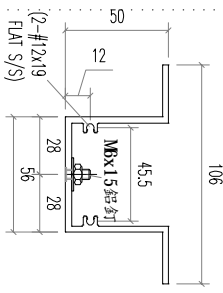
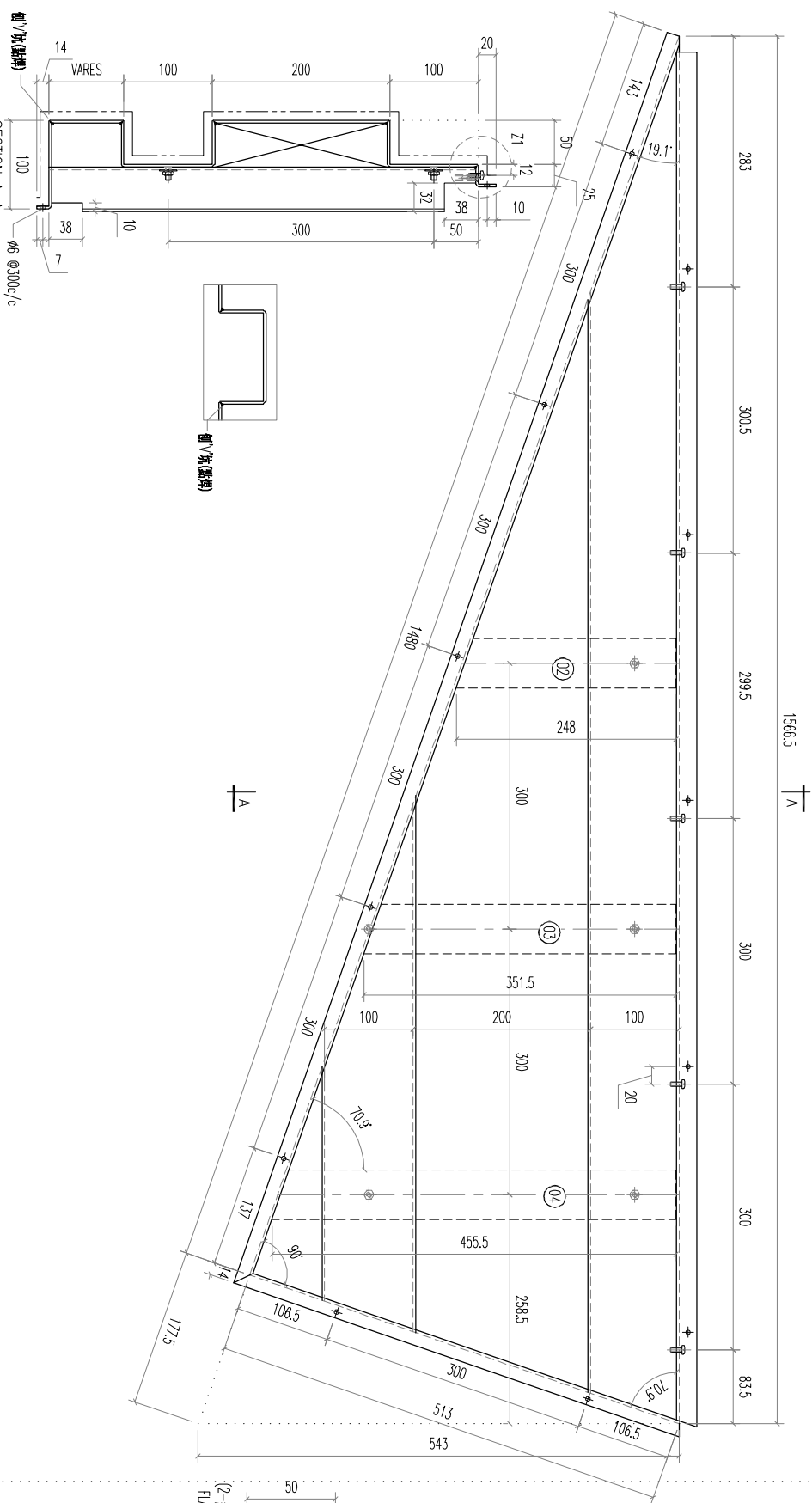

REV.	DATE	AMENDMENT	REVISED BY
04		A1 鋁型材	455.5
03		A1 鋁型材	351.5
02		A1 鋁型材	248

序号	材料规格	长度	配件描述	数量	备注
04	A1 鋁型材	455.5	开料	1	
03	A1 鋁型材	351.5	开料	1	
02	A1 鋁型材	248	开料	1	

**美特鋁質有限公司**  
MIDI ALUMINIUM FABRICATOR LTD.  
Units 6-8, Sunroy Industrial Centre, 1/F  
610 Cha Kwo Ling Road, Kowloon  
Tel: 23489211-4 Fax: (852) 27727666

REV.	DATE	AMENDMENT	REVISED BY

PROJECT	JOB NO.	DRAWING TITLE
J853-PODIUM ALUM CEILING & FEATURE CLADDING T7 7/F	J853	鋁板天花加工圖 3mm THK. ALUM PLATE

FACTORY	W/CENTRE	CUT ENDS	FINISH	DATE	DRAWN	POST PAINT	PART	SHT.	REV.
01	MAX/SCBA/FAB		EC-DG-0334232-201 (AL1)	4/19/2023	YEUNG	SCALE	SCALE	1:5	

REV.	CHECKED DATE	PART NUMBER	Dim. A	Dim. B	Dim. C	Dim. D	Dim. E	Dim. F	Dim. G	QTY	Inv. Code	ASSEMBLE ON PARTS	EXTR. DRAWING PART DRAWING
-		T7-CE02-04-03								1			

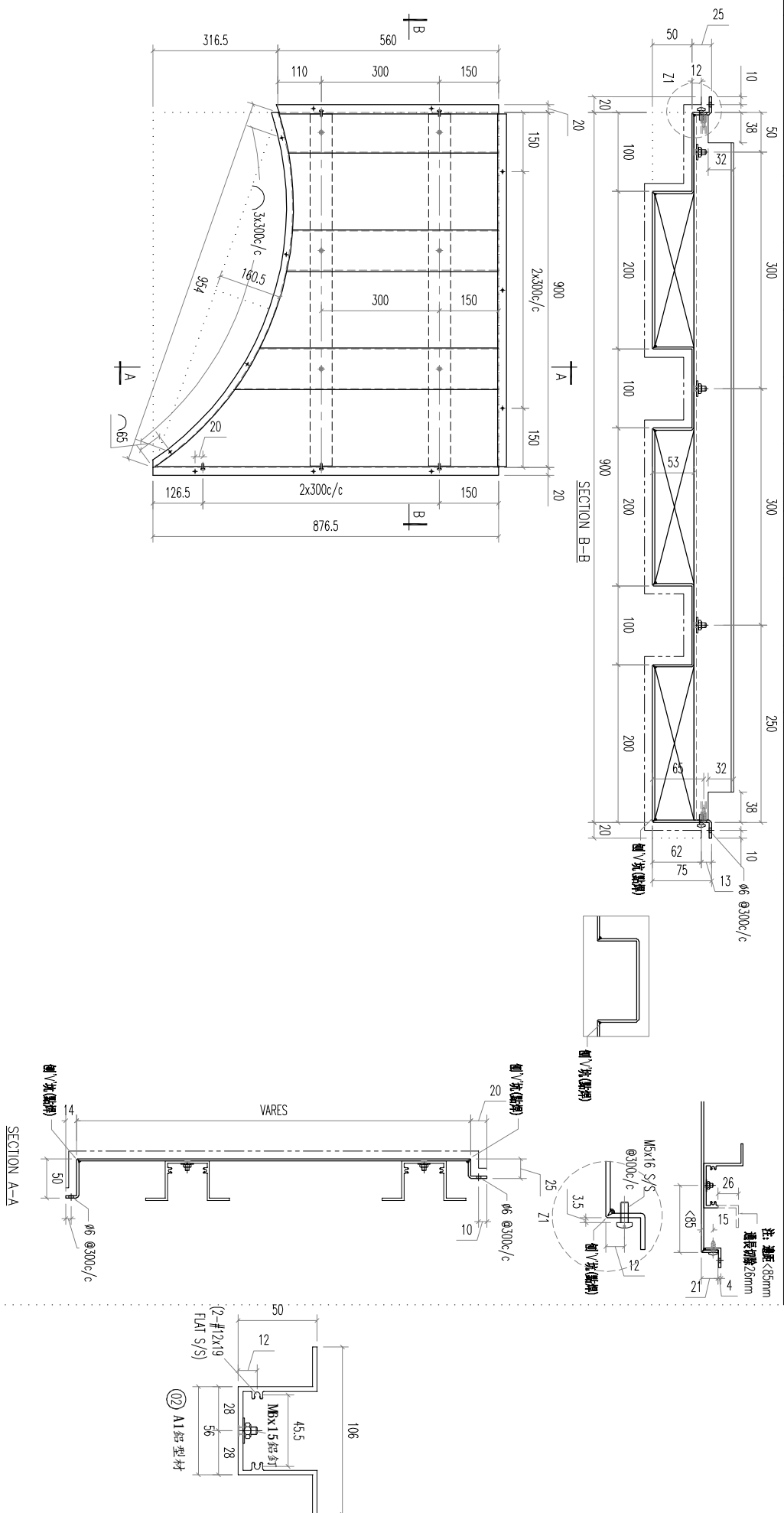

02	A1 铝型材	893	开料	2	
序号	材料规格	长度	配件描述	数量	备注

**美特铝质有限公司**  
MIDI ALUMINIUM FABRICATOR LTD.  
Units 6-8, Sunray Industrial Centre, 1/F  
610 Cho Kwo Ling Road, Kowloon  
Tel:23489211-4 Fax:(852)27727666

REV	DATE	AMENDMENT	REVISED BY	PROJECT	JOB NO.	DRAWING TITLE	DRAWING NO.	SHT.	REV.
				J853-PODIUM ALUM CEILING & FEATURE CLADDING T7 7/F	J853	铝板天花加工图 3mm THK. ALUM PLATE	T7-CE02-04-03	-/-	-
				FACTORY 01	W/CENTRE	CUT ENDS	FINISH	POST PAINT	PART
				Standard	MBX6/F/SKBA/FAB	Angle	EC-DG-0334232-Z01 (AL1)	PRE PAINT	SUB ASSEM.
				Tolerances X X . X = ±1	Squareness ±1°	DATE	4/19/2023	SCALE	TRACK TYPE
								1:5	S.....



REV.	CHECKED BY	PART NUMBER	Dim. A	Dim. B	Dim. C	Dim. D	Dim. E	Dim. F	Dim. G	QTY	Inv. Code	ASSEMBLY ON PARTS	EXTR. PART DRAWING
1		T7-CE02-06-03								1			

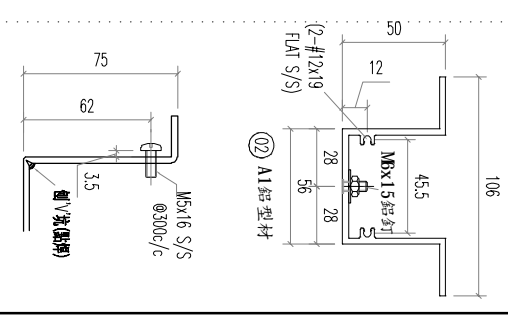
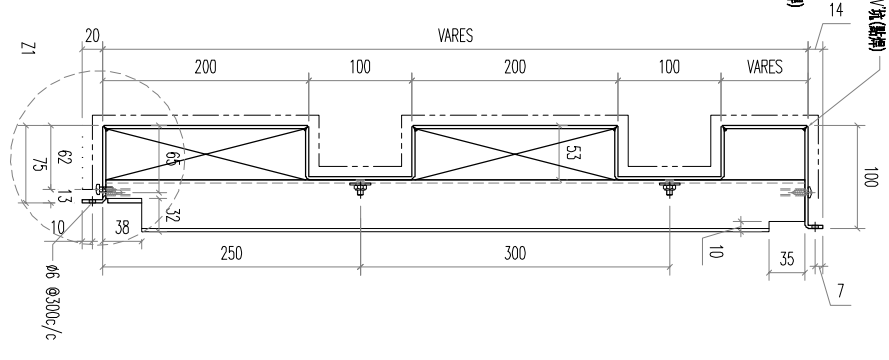
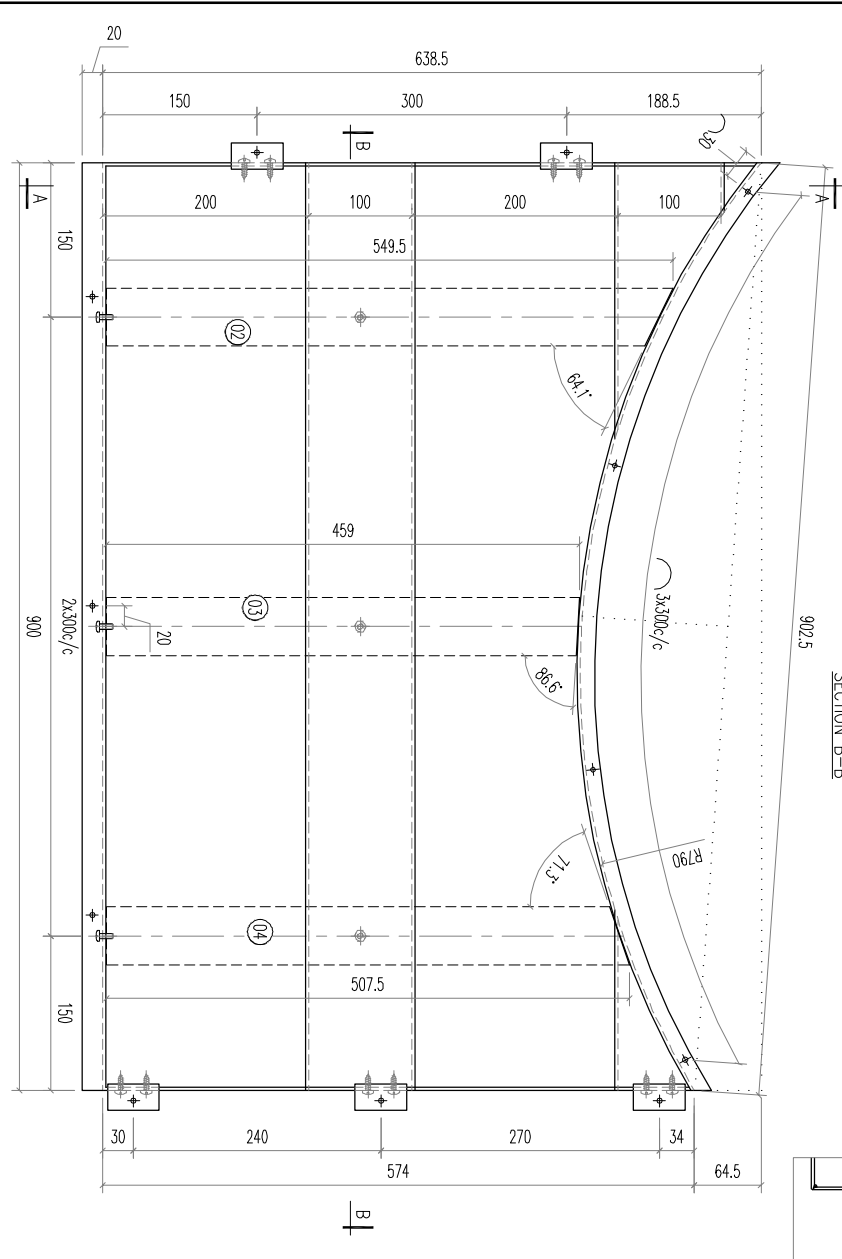
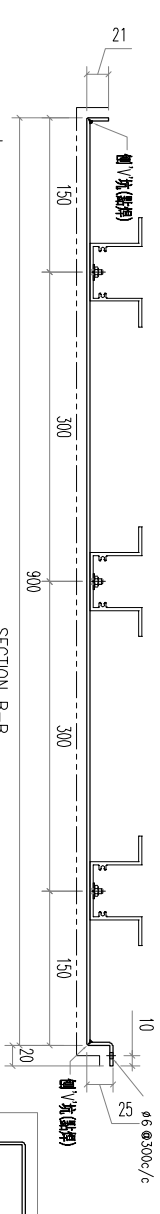

REV.	DATE	AMENDMENT	REVISED BY
04		A1 鋁型材	507.5
03		A1 鋁型材	459
02		A1 鋁型材	549.5

序號	材料規格	長度	配件描述	數量	备注

**美特鋁質有限公司**  
MIDI ALUMINIUM FABRICATOR LTD.  
Units 6-8, Sunroy Industrial Centre, 1/F  
610 Cho Kwo Ling Road, Kowloon  
Tel: 23489211-4 Fax: (852) 27727666

PROJECT	J853-PODIUM ALUM CEILING & FEATURE CLADDING T7 7/F	JOB NO.	J853	DRAWING TITLE	鋁板天花加工圖 3mm THK. ALUM PLATE	DRAWING NO.	T7-CE02-06-03	SHT.	-/-	REV.	-
FACTORY	01	W/CENTRE	MARK/SCBA/FAB	CUT ENDS		FINISH	EC-DG-0334232-201 (AL1)	POST PAINT		PART	
Standard	X X . = ±1	Angle	±1°	DATE	4/19/2023	DRAWN	YEUNG	PRE PAINT		SUB ASSEM.	
Tolerances	X X . X = ±0.5	Squareness	±1°	SCALE	1:5	TRACK TYPE	S.....				

REV.	CHECKED DATE BY	PART NUMBER	Dim. A	Dim. B	Dim. C	Dim. D	Dim. E	Dim. F	Dim. G	QTY	Inv. Code	EXTR. DRAWING PART DRAWING
-		T7-CE02-07-03								1		

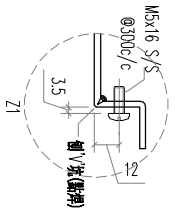
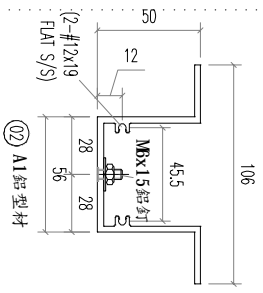
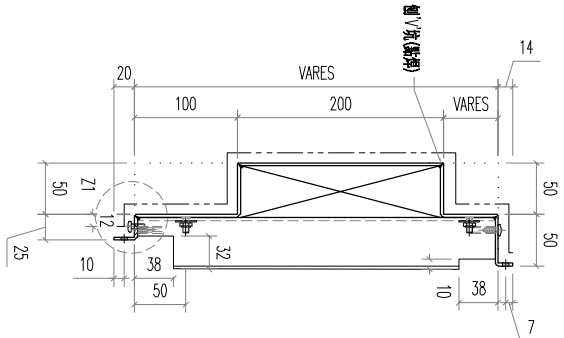
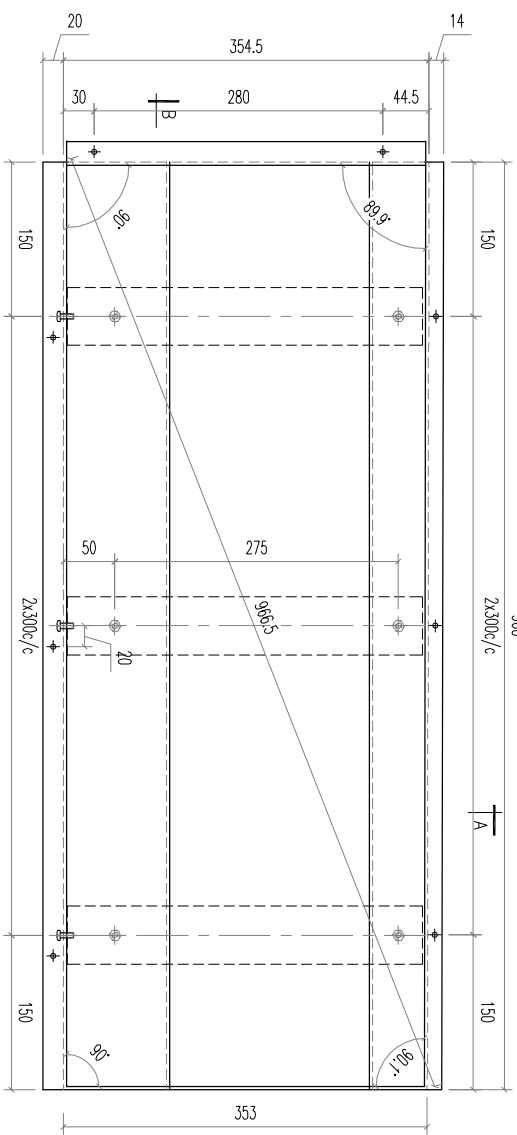
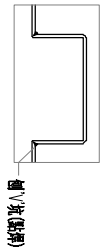
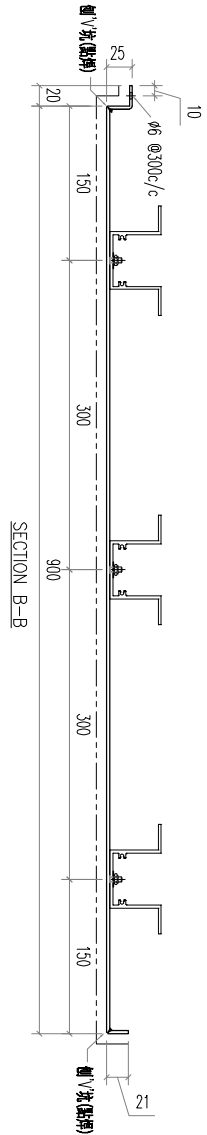

02	A1 鋁型材	346.5	開料	3	
REV.	材料規格	長度	配件描述	數量	备注
DATE					
AMENDMENT					
REVISED BY					
<p>  <b>美特鋁質有限公司</b>  <b>MIDI ALUMINIUM FABRICATOR LTD.</b>            Units 6-8, Sunroy Industrial Centre, 1/F            610 Cha Kwo Ling Road, Kowloon            Tel:23489211-4 Fax:(852)27727666         </p> <p> <b>PROJECT</b> J853-PODIUM ALUM CEILING  <b>&amp; FEATURE CLADDING T7 7/F</b> </p> <p> <b>JOB NO.</b> J853         </p> <p> <b>FACTORY</b> 01  <b>W/CENTRE</b> WCKX/SKBA/FAB  <b>CUT ENDS</b> Angle ±1°  <b>FINISH</b> EC-D6-0334232-201 (AL1)  <b>DATE</b> 4/19/2023  <b>DRAWING TITLE</b> 鋁板天花加工圖  <b>3mm THK. ALUM PLATE</b> </p> <p> <b>DRAWING NO.</b> T7-CE02-07-03         </p> <p> <b>POST PAINT</b> PRE PAINT  <b>SCALE</b> 1:5  <b>PART</b> SUB ASSEM.  <b>SHT.</b> -/-  <b>REV.</b> -         </p>					

REV.	CHECKED	PART NUMBER	Dim. A	Dim. B	Dim. C	Dim. D	Dim. E	Dim. F	Dim. G	QTY	Inv. Code	ASSEMBLE ON PARTS	EXTR. DRAWING
-	BAR BY	T7-CE02-08-03								1			PART DRAWING

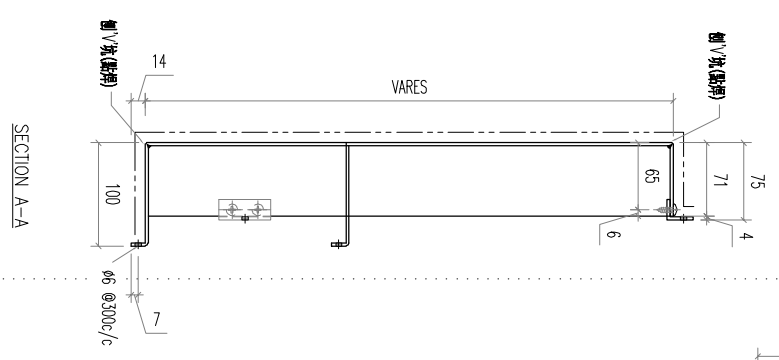
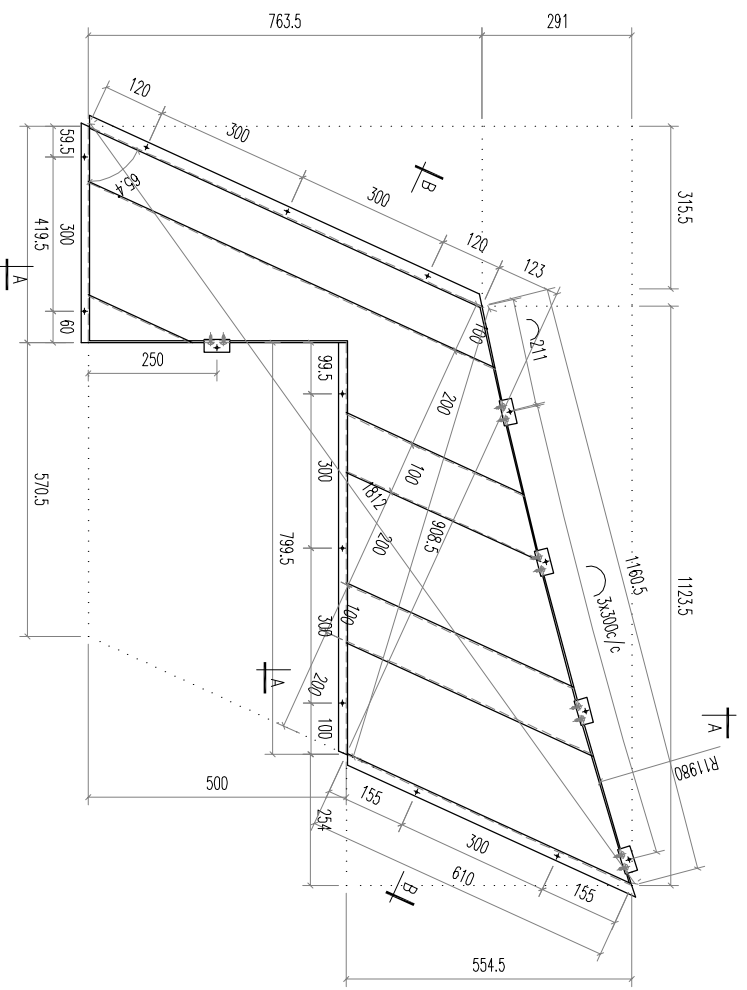
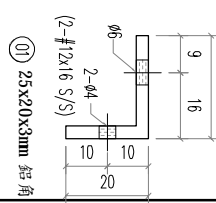
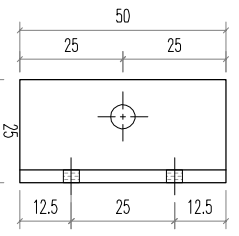
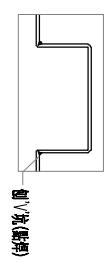
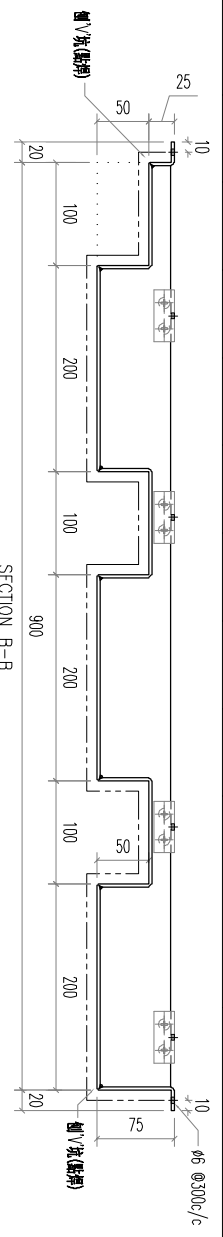

REV.	DATE	AMENDMENT	REVISED BY	PROJECT	JOB NO.	DRAWING TITLE	DRAWING NO.	SHT.	REV.
				J853-PODIUM ALUM CEILING & FEATURE CLADDING T7 7/F	J853	铝板天花加工图 3mm THK. ALUM PLATE	T7-CE02-08-03	-/-	-

**美特铝质有限公司**  
MIDI ALUMINIUM FABRICATOR LTD.  
Units 6-8, Sunroy Industrial Centre, 1/F  
610 Cho Kwo Ling Road, Kowloon  
Tel: 23489211-4 Fax: (852) 27727666

FACTORY	W/CENTRE	CUT ENDS	FINISH	DATE	DRAWN	SCALE
01	WXXX/SXXX/FAB	Angle	EC-DG-0334232-201 (AL1)	4/19/2023	YEUNG	1:5

01	25x20x3mm 铝角	50	开料	5	
	材料规格	长度	配件描述	数量	备注

REV.	CHECKED BAR BY	PART NUMBER	Dim. A	Dim. B	Dim. C	Dim. D	Dim. E	Dim. F	Dim. G	QTY	Inv. Code	ASSEMBLE ON PARTS	EXTR. DRAWING PART DRAWING
-		T7-CE02-09-03								1			

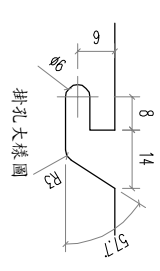
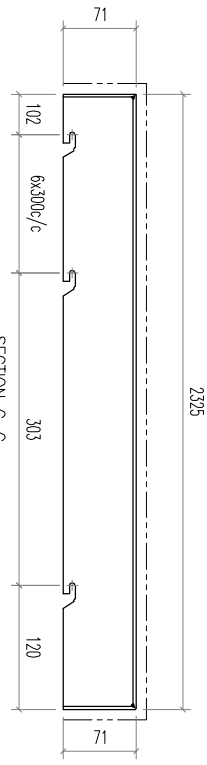
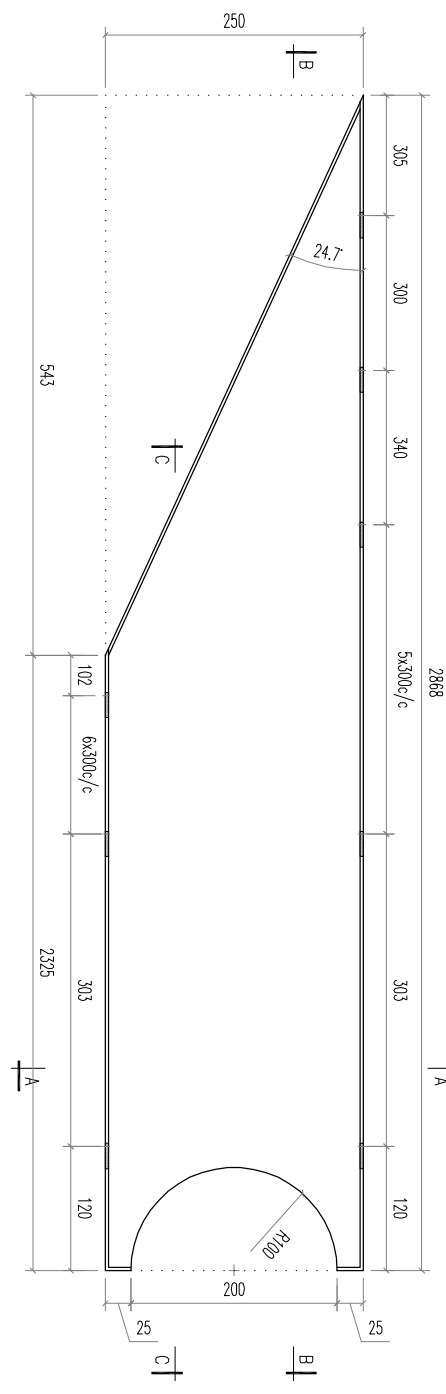
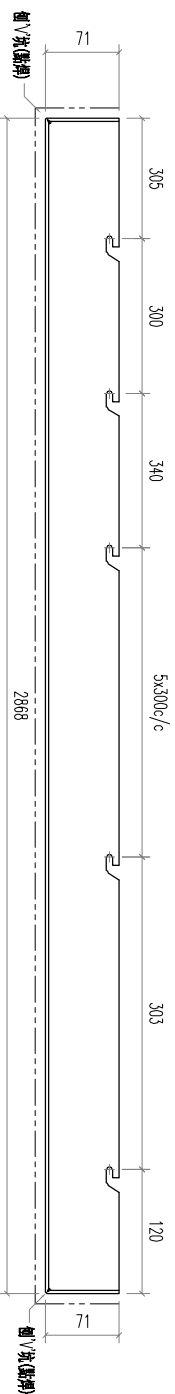

REV.	DATE	AMENDMENT	REVISED BY	<b>美特鋁質有限公司</b> MIDI ALUMINIUM FABRICATOR LTD. Units 6-8, Sunroy Industrial Centre, 1/F 610 Cho Kwo Ling Road, Kowloon Tel:23489211-4 Fax:(852)27727666				PROJECT	JOB NO.	DRAWING TITLE	FACTORY	W/CENTRE	CUT ENDS	FINISH	DRAWN	POST PAINT	PART	SHT.	REV.		
								J853-PODIUM ALUM CEILING	J853	鋁板天花加工圖	Standard	XXXX = ±1	Angle	±1'	4/19/2023	YEUNG	SCALE	1:5	TRACK TYPE	S.....	
								& FEATURE CLADDING T7 7/F		3mm THK. ALUM PLATE	Tolerances	XXXX = ±05	Squareness	±1'							

REV.	CHECKED	PART NUMBER	Dim. A	Dim. B	Dim. C	Dim. D	Dim. E	Dim. F	Dim. G	QTY	Inv. Code	ASSEMBLE ON PARTS	EXTR. DRAWING
1	BAR BY	T7-CE02-01-04								1			PART DRAWING

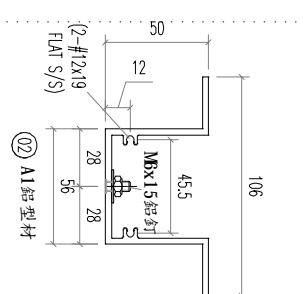
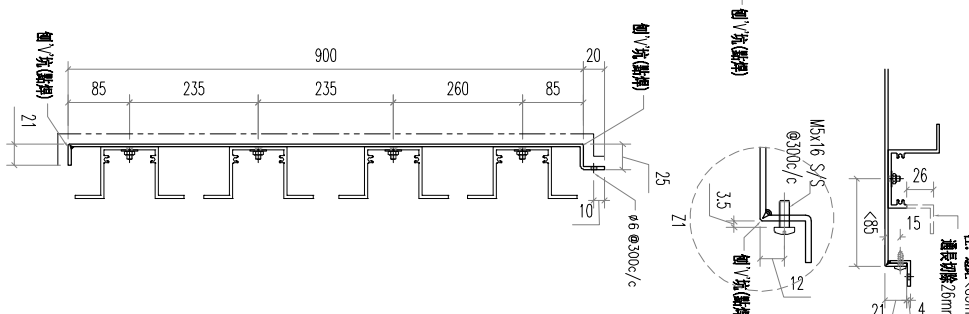
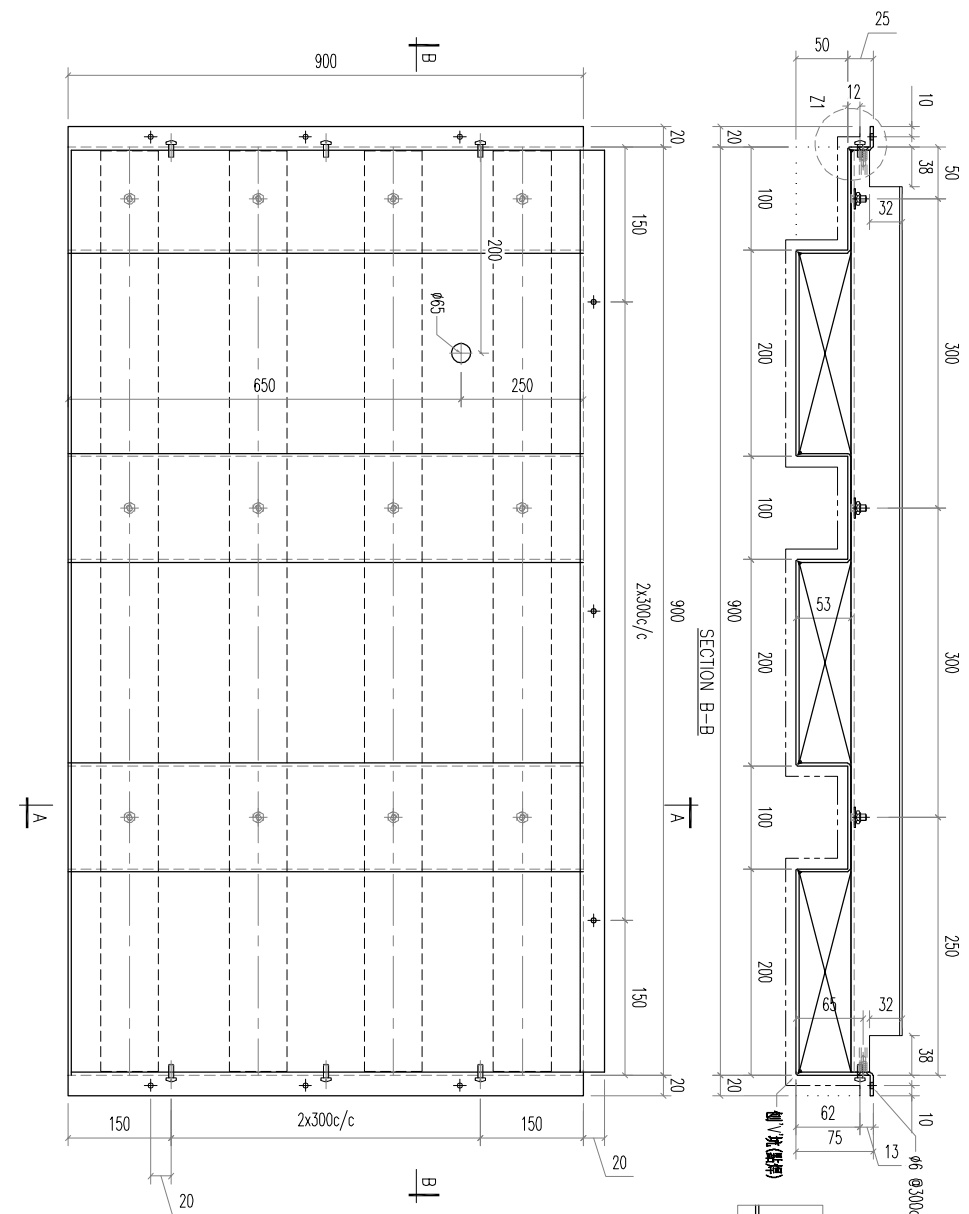

02	A1鋁型材	893	開料	4	
序號	材料規格	長度	配件描述	數量	备注

**美特鋁質有限公司**  
**MIDI ALUMINIUM FABRICATOR LTD.**  
 Units 6-8, Sunroy Industrial Centre, 1/F  
 610 Cho Kwo Ling Road, Kowloon  
 Tel:23489211-4 Fax:(852)27727666

REV.	DATE	AMENDMENT	REVISED BY	PROJECT	JOB NO.	DRAWING TITLE	DRAWING NO.	SHT.	REV.
				J853-PODIUM ALUM CEILING & FEATURE CLADDING T7 7/F	J853	鋁板天花加工圖 3mm THK. ALUM PLATE	T7-CE02-01-04	-/-	-

REV.	CHECKED DATE	PART NUMBER	Dim. A	Dim. B	Dim. C	Dim. D	Dim. E	Dim. F	Dim. G	QTY	Inv. Code	ASSEMBLE ON PARTS	EXTR. DRAWING PART DRAWING
-		T7-CE02-02-04								1			

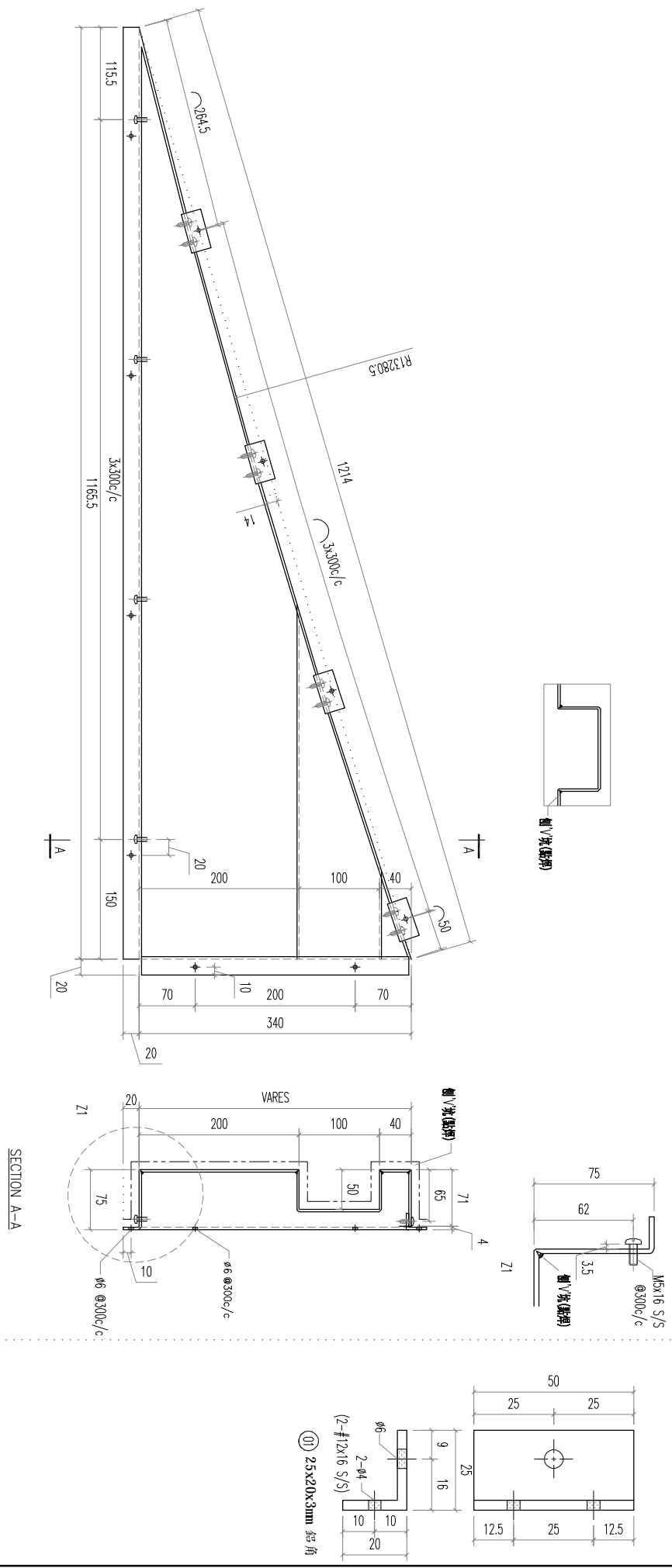

01	25x20x3mm 鋁角	50	開料	4	
REV.	DATE	AMENDMENT	REVISED BY		
<p> <b>美特鋁質有限公司</b>  <b>MIDI ALUMINIUM FABRICATOR LTD.</b>          Units 6-8, Sunroy Industrial Centre, 1/F          610 Cha Kwo Ling Road, Kowloon          Tel:23489211-4 Fax:(852)27727666       </p>					
PROJECT		JOB NO.			
J853-PODIUM ALUM CEILING		J853			
& FEATURE CLADDING T7 7/F		DRAWING TITLE			
		3mm THK. ALUM PLATE			
FACTORY		FINISH			
01		EC-DG-0334232-201 (AL1)			
W/CENTRE		DATE			
M804/SK04/FAB		4/19/2023			
CUT ENDS		DRAWN			
Standard X X . = ±1		YEUNG			
Tolerances X X . X = ±05		SCALE			
Angle Squareness ±1°		1:5			
DRAWING NO.		SHT.			
T7-CE02-02-04		-/-			
REV.		REV.			
		-			

REV.	CHECKED	PART NUMBER	Dim. A	Dim. B	Dim. C	Dim. D	Dim. E	Dim. F	Dim. G	QTY	Inv. Code	ASSEMBLE ON PARTS	EXTR. DRAWING
1	BAR BY	T7-CE02-04-04								1			PART DRAWING

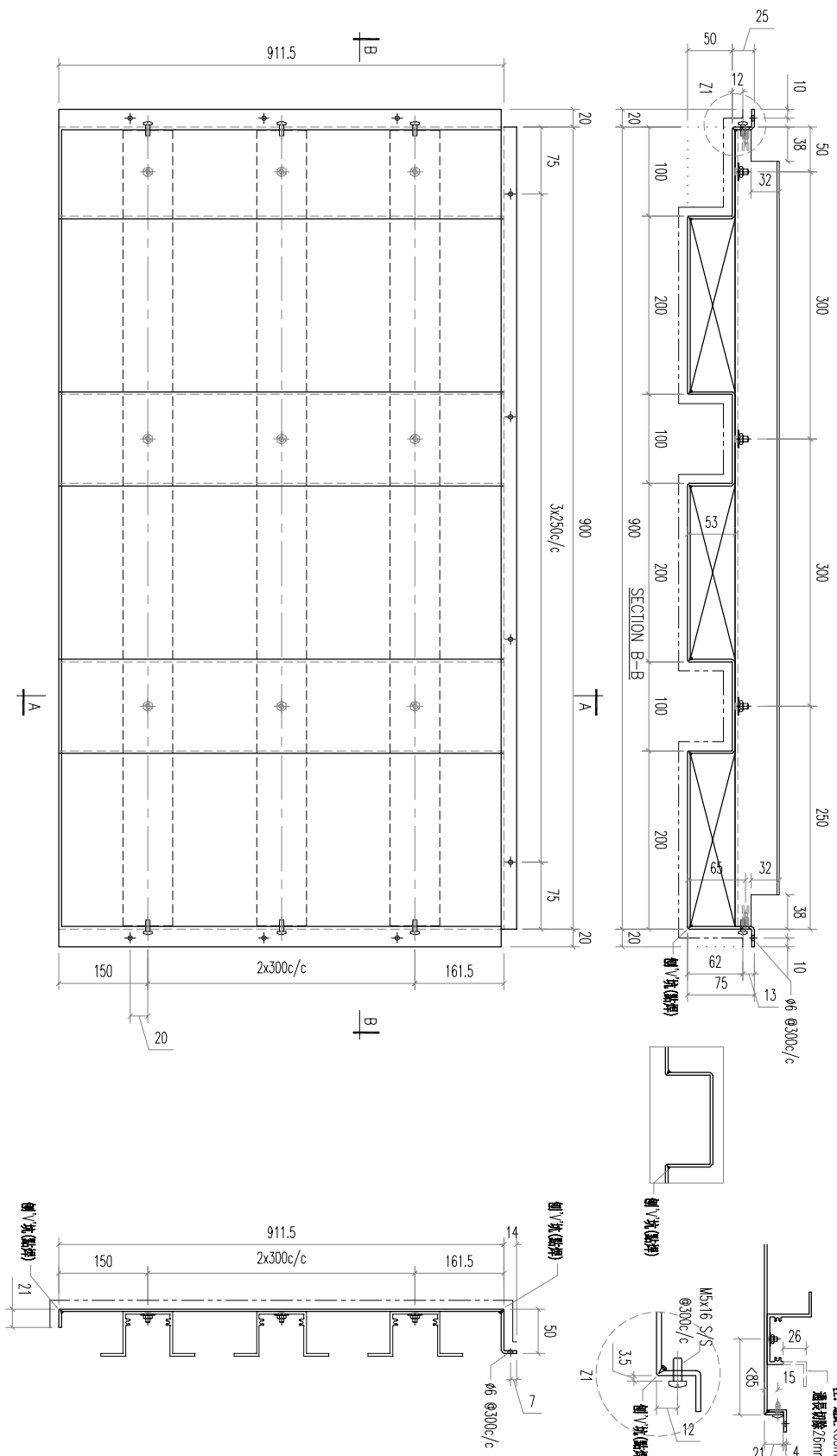

SECTION A-A

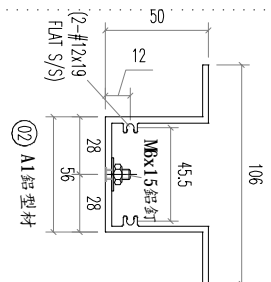

02	A1 鋁型材	893	開料	3	
REV.	材料規格	長度	配件描述	數量	备注
DATE	AMENDMENT	REVISED BY	PROJECT J853-PODIUM ALUM CEILING & FEATURE CLADDING T7 7/F		
<p><b>美特鋁質有限公司</b>  <b>MIDI ALUMINIUM FABRICATOR LTD.</b>          Units 6-8, Sunroy Industrial Centre, 1/F          610 Cha Kwo Ling Road, Kowloon          Tel:23489211-4 Fax:(852)2727666</p>					
JOB NO. J853		DRAWING TITLE 鋁板天花加工圖 3mm THK. ALUM PLATE		DRAWING NO. T7-CE02-04-04	
FACTORY 01		W/CENTRE W/BOX/SKID/FAB		CUT ENDS	
Standard		X X . X = ±1		Angle ±1°	
Tolerances		X X . X = ±05		Squariness ±1°	
DATE 4/19/2023		FINISH EC-DG-0334232-201 (AL1)		噴漆	
DRAWN YEUNG		SCALE 1:5		PART SUB ASSEM.	
SHT. -/-		REV. -			

REV.	CHECKED	PART NUMBER	Dim. A	Dim. B	Dim. C	Dim. D	Dim. E	Dim. F	Dim. G	QTY	Inv. Code	ASSEMBLE ON PARTS	EXTR. DRAWING
—	BAR BY	T7-CE02-05-04								1			PART DRAWING
序号	材料规格	长度	配件描述	数量	备注								
01	2.5X20X3mm 铝角	50	开料	9									

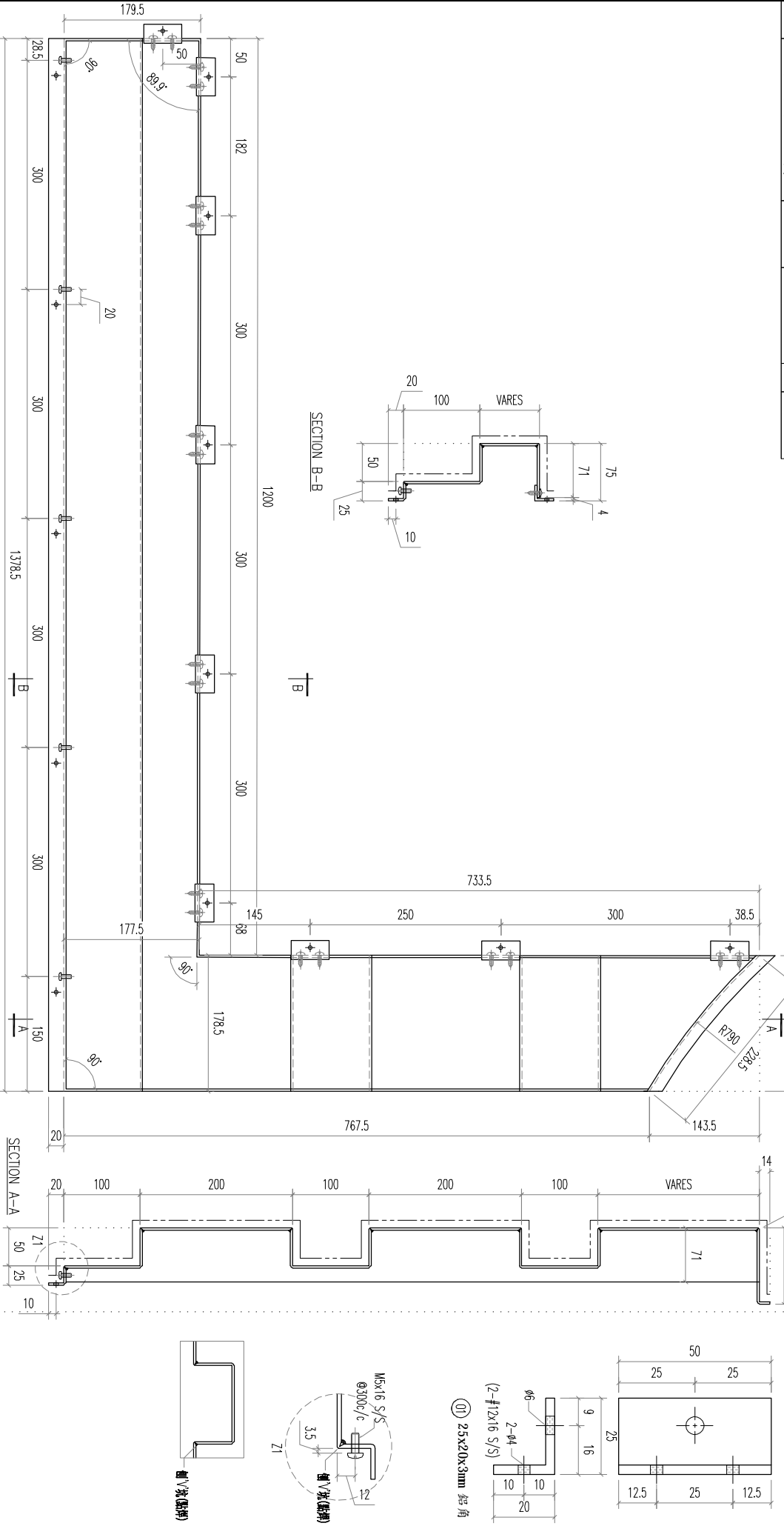

REV.	DATE	AMENDMENT	REVISED BY	PROJECT	JOB NO.	DRAWING TITLE	FACTORY	W/CENTRE	CUT ENDS	FINISH	DATE	DRAWN	POST PAINT	PART	SHT.	REV.
				8553-PODIUM ALUM CEILING & FEATURE CLADDING T7 7/F	8553	鋁板天花加工圖 3mm THK. ALUM PLATE	01	MOKA/SKBA/FAB	±1	EC-DG-0334232-201 (AL1)	4/19/2023	YEUNG	1:5	SUB ASSEM.	-/-	—
				<b>美特鋁質有限公司</b> <b>MIDI ALUMINIUM FABRICATOR LTD.</b> Units 6-8, Sunroy Industrial Centre, 1/F 610 Cha Kwo Ling Road, Kowloon Tel:23489211-4 Fax:(852)2727666												

REV.	CHECKED BY	PART NUMBER	Dim. A	Dim. B	Dim. C	Dim. D	Dim. E	Dim. F	Dim. G	QTY	Inv. Code	ASSEMBLE ON PARTS	EXTR. DRAWING PART DRAWING
-		T7-CE02-06-04								1			

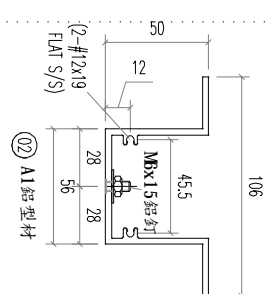
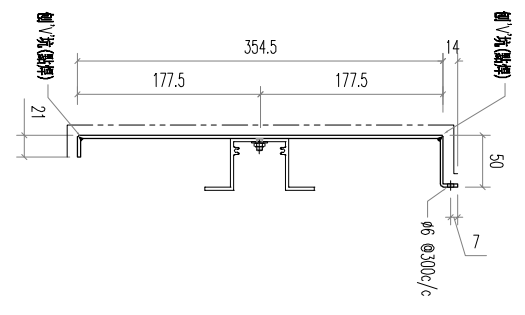
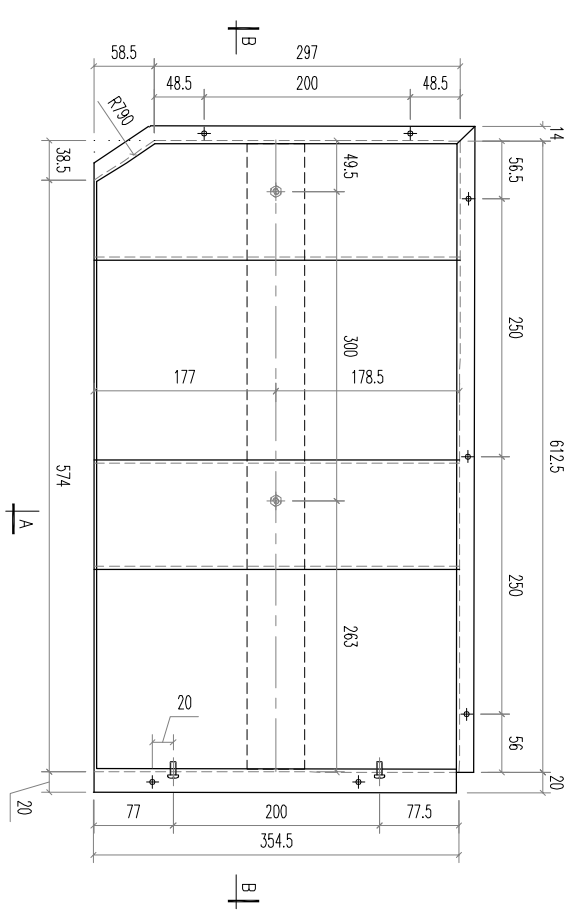
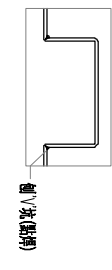
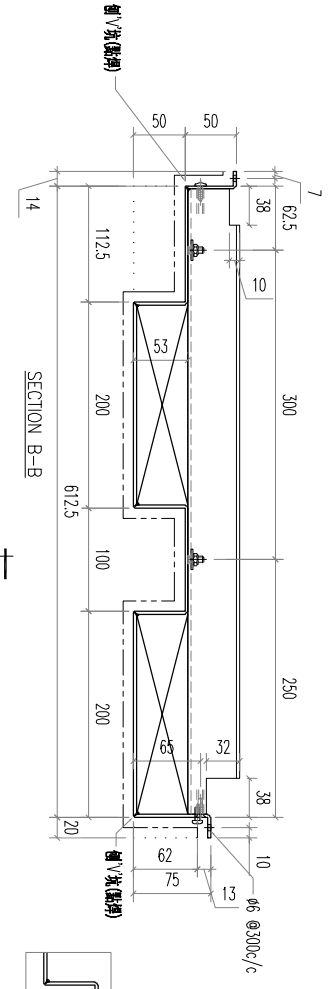

SECTION A-A

REV.	DATE	AMENDMENT	REVISED BY
02			

REV.	DATE	AMENDMENT	REVISED BY
02			

REV.	DATE	AMENDMENT	REVISED BY
02			

材料規格	605	開料	1	備註
材料規格	長度	配件描述	數量	
PROJECT	J853-PODIUM ALUM CEILING	JOB NO.	J853	
& FEATURE CLADDING T7 7/F				
Units 6-8, Sunroy Industrial Centre, 1/F	610 Cho Kwo Ling Road, Kowloon	Tel:23489211-4	Fax:(852)2727666	
美特鋁質有限公司	MIDI ALUMINIUM FABRICATOR LTD.			
FACTORY	01	W/CENTRE	MARK/SCALE/FAB	CUT ENDS
Standard	X X .	= ±1	Angle	±1°
Tolerances	X X . X = ±05	Squareness	±1°	
DATE	4/19/2023	FINISH	EC-D6-0334232-201 (AL1)	噴漆
DRAWING TITLE	鋁板天花加工圖	DRAWN	YEUNG	
3mm THK. ALUM PLATE		POST PAINT	SCALE	1:5
DRAWING NO.	T7-CE02-06-04	PART	TRACK TYPE	S.....
SHT.	-/-	REV.		

REV.	CHECKED DATE	PART NUMBER	Dim. A	Dim. B	Dim. C	Dim. D	Dim. E	Dim. F	Dim. G	QTY	Inv. Code	ASSEMBLE ON PARTS	EXTR. DRAWING PART DRAWING
-		T7-CE02-07-04								1			

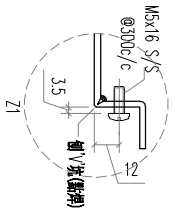
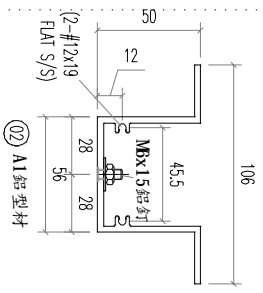
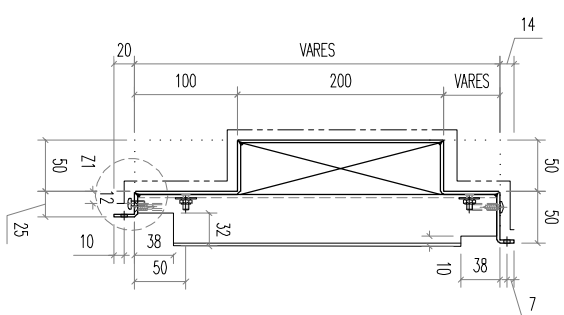
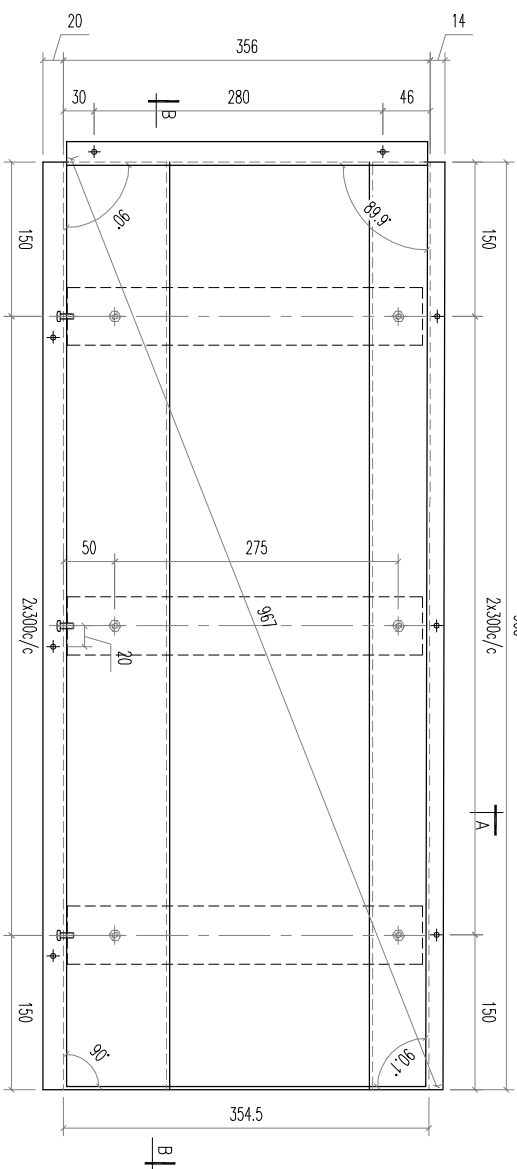
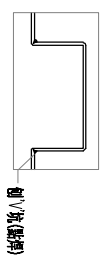
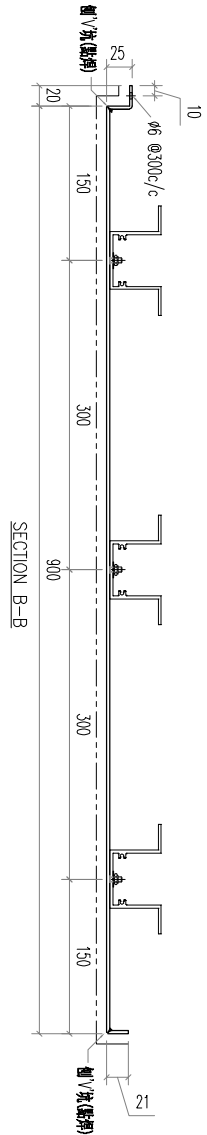

02	A1 鋁型材	348	開料	3	
REV#	材料規格	長度	配件描述	數量	备注
REV#	DATE	AMENDMENT	REVISED BY		
<p><b>美特鋁質有限公司</b>  <b>MIDI ALUMINIUM FABRICATOR LTD.</b>          Units 6-8, Sunroy Industrial Centre, 1/F          610 Cho Kwo Ling Road, Kowloon          Tel:23489211-4 Fax:(852)27727666</p> <p>PROJECT: J853-PODIUM ALUM CEILING &amp; FEATURE CLADDING T7 7/F          JOB NO. J853</p> <p>FACTORY 01 W/CENTRE MBX/SCBA/FAB CUT ENDS Angle ±1° DATE 4/19/2023          Standard X X . X ±1          Tolerances X X . X = ±05 Squariness ±1°</p> <p>FINISH EC-DG-0334232-201 (AL1) 噴漆          DRAWING NO. T7-CE02-07-04</p> <p>POST PAINT PRE PAINT SCALE 1:5 PART SUB ASSEM. TRACK TYPE S....</p>					

REV.	CHECKED DATE	PART NUMBER	Dim. A	Dim. B	Dim. C	Dim. D	Dim. E	Dim. F	Dim. G	QTY	Inv. Code	ASSEMBLE ON PARTS	EXTR. DRAWING PART DRAWING
-		T7-CE02-08-04								1			

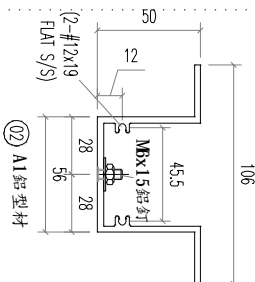
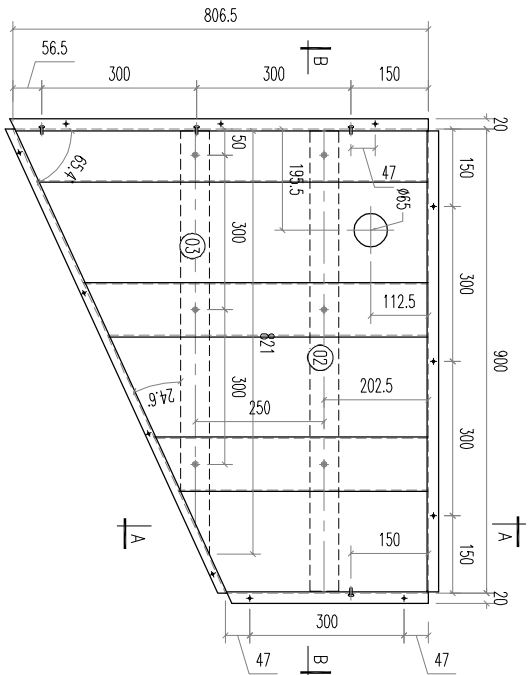
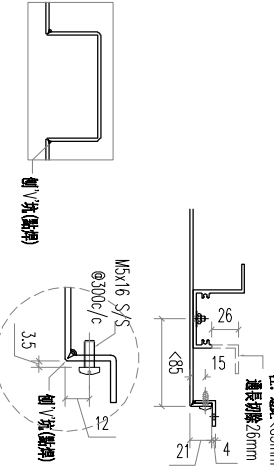
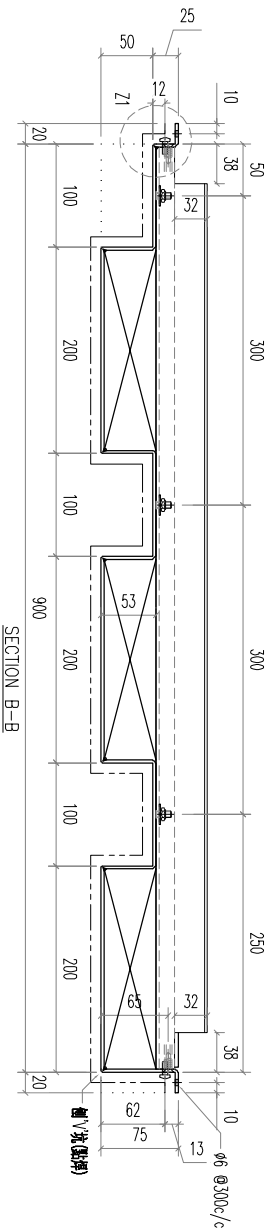

SECTION A-A

REV.	DATE	AMENDMENT	REVISED BY
03		A1 鋁型材	
02		A1 鋁型材	
		材料規格	
		長度	
		配件描述	
		數量	
		备注	

**美特鋁質有限公司**  
 MIDI ALUMINIUM FABRICATOR LTD.  
 Units 6-8, Sunroy Industrial Centre, 1/F  
 610 Cho Kwo Ling Road, Kowloon  
 Tel: 23489211-4 Fax: (852) 27727666

PROJECT: J853-PODIUM ALUM CEILING & FEATURE CLADDING T7 7/F  
 JOB NO.: J853

FACTORY	W/CENTRE	CUT ENDS	FINISH	DATE	DRAWN	POST PAINT	PART
01	W/CENTRE	CUT ENDS	EC-DG-0334232-201 (AL1)	4/19/2023	YEUNG	SCALE	PART
Standard	X X . = ±1	Angle	±1°			SCALE	PART
Tolerances	X X . X = ±05	Squareness	±1°			SCALE	PART

DRAWING TITLE	DRAWING NO.	SHT.	REV.
鋁板天花加工圖 3mm THK. ALUM PLATE	T7-CE02-08-04	-/-	-

REV.	CHECKED	PART NUMBER	Dim. A	Dim. B	Dim. C	Dim. D	Dim. E	Dim. F	Dim. G	QTY	Inv. Code	ASSEMBLE ON PARTS	EXTR. DRAWING
—	BAR BY	T7-CE02-09-04								5			PART DRAWING

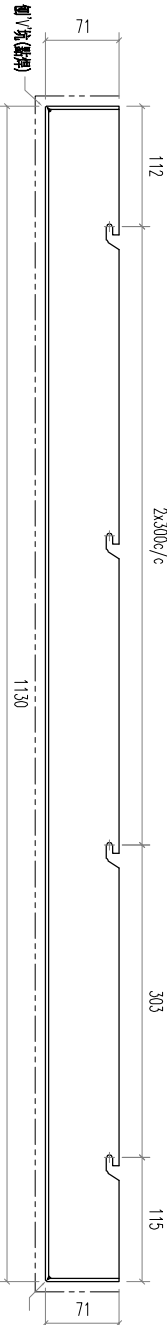

SECTION B-B

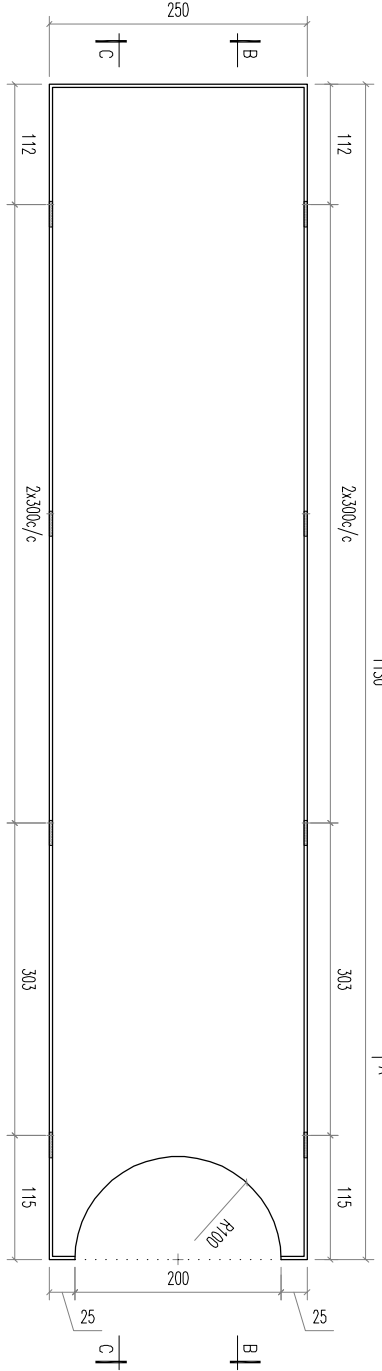

SECTION A-A

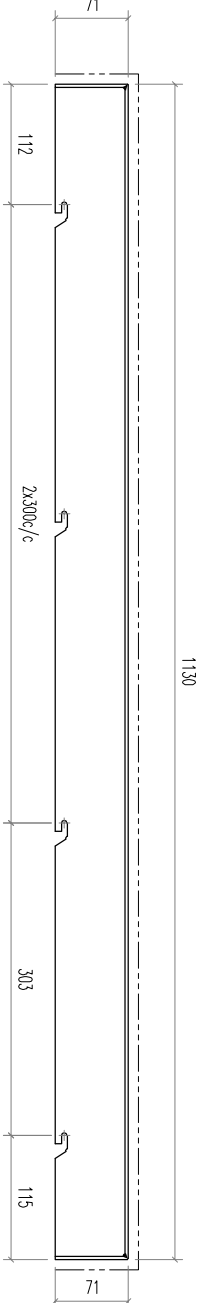

SECTION C-C

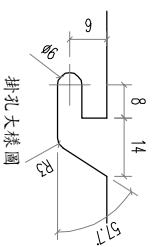

**美特鋁質有限公司**  
MIDI ALUMINIUM FABRICATOR LTD.  
Units 6-8, Sunroy Industrial Centre, 1/F  
610 Cho Kwo Ling Road, Kowloon  
Tel:23489211-4 Fax:(852)27727666

PROJECT J853-PODIUM ALUM CEILING  
& FEATURE CLADDING T7 7/F  
JOB NO. J853

FACTORY	W/CENTRE	CUT ENDS	FINISH	DRAWING NO.	POST PAINT	PART
01	MARK/SKID/FAB			77-CE02-09-04		
Standard	X X . = ±1	Angle	DATE	DRAWN	SCALE	TRACK TYPE
Tolerances	X X . X = ±05	Squareness ±1°	4/19/2023	YEUNG	1:5	S.....
DRAWING TITLE			DRAWING NO.			
鋁板天花加工圖 3mm THK. ALUM PLATE			T7-CE02-09-04			
REV.	DATE	AMENDMENT	REVISED BY	SHT.	REV.	
				-/-	-	

REV.	CHECKED	PART NUMBER	Dim. A	Dim. B	Dim. C	Dim. D	Dim. E	Dim. F	Dim. G	QTY	Inv. Code	ASSEMBLE ON PARTS	EXTR. DRAWING
1	BAR BY	T7-CE02-01-05								2			PART DRAWING



02	A1 鋁型材	893	開料	4	
REV.	材料規格	長度	配件描述	數量	备注
REV.	DATE	AMENDMENT	REVISED BY		
<p><b>美特鋁質有限公司</b>  <b>MIDI ALUMINIUM FABRICATOR LTD.</b>          Units 6-8, Sunroy Industrial Centre, 1/F          610 Cho Kwo Ling Road, Kowloon          Tel: 23489211-4 Fax: (852) 27727666</p> <p>PROJECT: J853-PODIUM ALUM CEILING &amp; FEATURE CLADDING T7 7/F          JOB NO. J853</p> <p>FACTORY 01 W/CENTRE MBX8/SKBA/FAB CUT ENDS DATE 4/19/2023          Standard X X . X = ±1 Angle ±1°          Tolerances X X . X = ±05 Squariness ±1°</p> <p>DRAWING TITLE: 鋁板天花加工圖 3mm THK. ALUM PLATE          DRAWING NO. T7-CE02-01-05</p> <p>噴漆 EC-DG-0334232-201 (AL1)          DRAWN YEUNG          POST PAINT PRE PAINT SCALE 1:5          PART SUB ASSEM. TRACK TYPE S.....</p>					

REV.	CHECKED BY	PART NUMBER	Dim. A	Dim. B	Dim. C	Dim. D	Dim. E	Dim. F	Dim. G	QTY	Inv. Code	ASSEMBLE ON PARTS	EXTR. DRAWING PART DRAWING
1		T7-CE02-02-05								1			

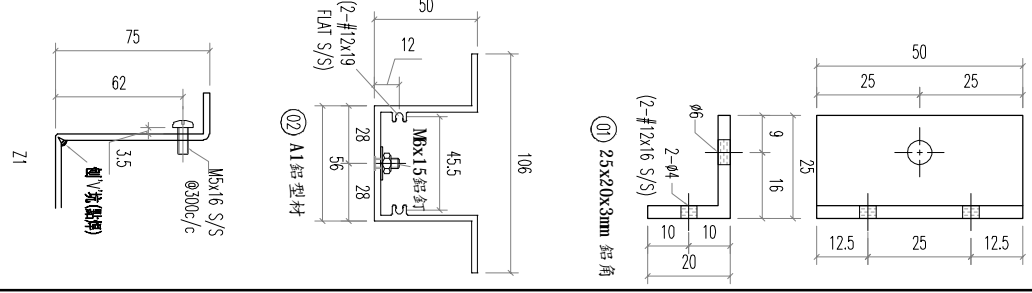
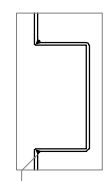
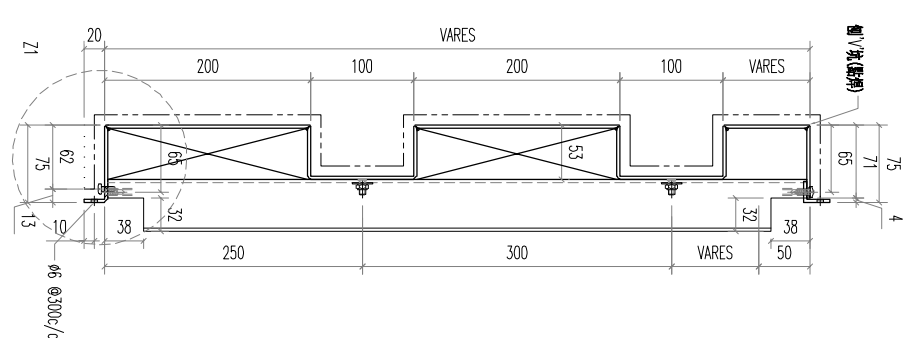
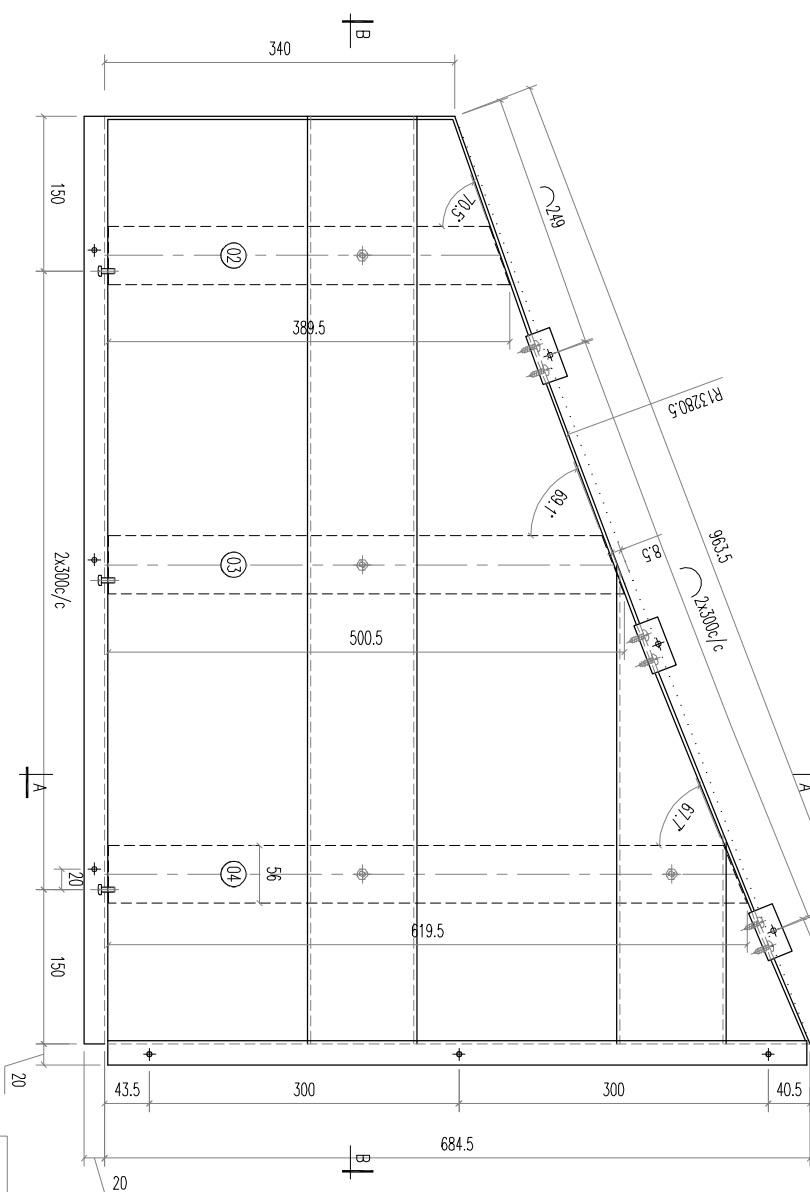
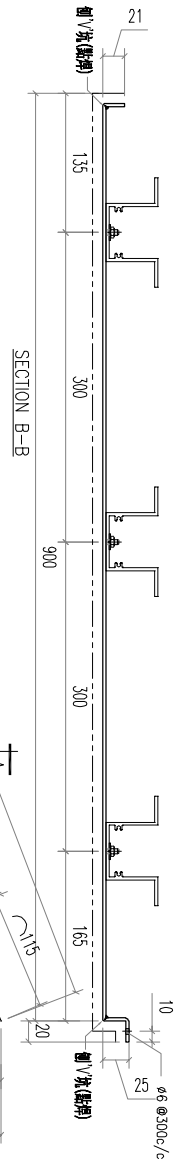

序号	材料规格	长度	配件描述	数量	备注
04	A1铝型材	619.5	开料	1	
03	A1铝型材	500.5	开料	1	
02	A1铝型材	389.5	开料	1	
01	2.5x20x3mm 铝角	50	开料	3	

**美特铝质有限公司**  
MIDI ALUMINIUM FABRICATOR LTD.  
Units 6-8, Sunray Industrial Centre, 1/F  
610 Cho Kwo Ling Road, Kowloon  
Tel:23489211-4 Fax:(852)2727666

REV.	DATE	AMENDMENT	REVISED BY	PROJECT	JOB NO.	DRAWING TITLE	DRAWING NO.	POST PAINT	PART	SHT.	REV.
				J853-PODIUM ALUM CEILING & FEATURE CLADDING T7 7/F	J853	铝板天花加工图 3mm THK. ALUM PLATE	T7-CE02-02-05	喷涂 EC-DG-0334232-201 (AL1)		-/-	-

REV.	CHECKED	PART NUMBER	Dim. A	Dim. B	Dim. C	Dim. D	Dim. E	Dim. F	Dim. G	QTY	Inv. Code	ASSEMBLE ON PARTS	EXTR. DRAWING
1	BAR BY	T7-CE02-04-05								1			PART DRAWING

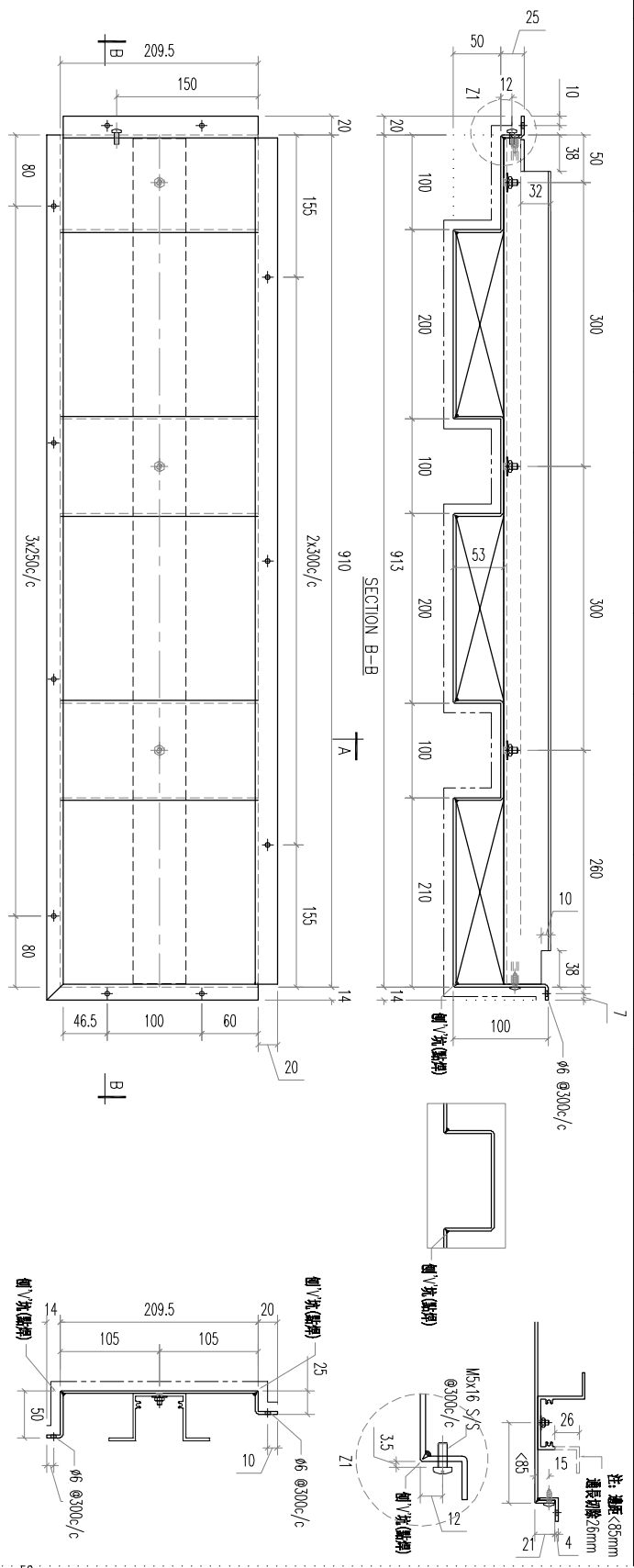

REV.	DATE	AMENDMENT	REVISED BY	REVISION	REVISION	REVISION	REVISION	REVISION	REVISION	REVISION	REVISION	REVISION	REVISION
02		A1 鋁型材											
序號	材料規格	長度	開料	數量	備註								
		903		1									
					<b>美特鋁質有限公司</b> <b>MIDI ALUMINIUM FABRICATOR LTD.</b> Units 6-8, Sunroy Industrial Centre, 1/F 610 Cho Kwo Ling Road, Kowloon Tel: 23489211-4 Fax: (852) 2727666								
					PROJECT J853-PODIUM ALUM CEILING & FEATURE CLADDING T7 7/F JOB NO. J853 DRAWING TITLE 鋁板天花加工圖 3mm THK. ALUM PLATE DRAWING NO. T7-CE02-04-05								
		FACTORY	W/CENTRE	CUT ENDS	FINISH	DATE	DRAWN	SCALE	POST PAINT	PART	SHT.	REV.	
		01	MAX/SCA/FAB	±1	EC-DG-0334232-201 (AL1)	4/19/2023	YEUNG	1:5			-/-	-	
		Standard	X X . X = ±1	Angle	±1'								
		Tolerances	X X . X = ±05	Squareness	±1'								



REV.	CHECKED	PART NUMBER	Dim. A	Dim. B	Dim. C	Dim. D	Dim. E	Dim. F	Dim. G	QTY	Inv. Code	ASSEMBLE ON PARTS	EXTR. DRAWING
1	BAR BY	T7-CE02-08-05								1			PART DRAWING

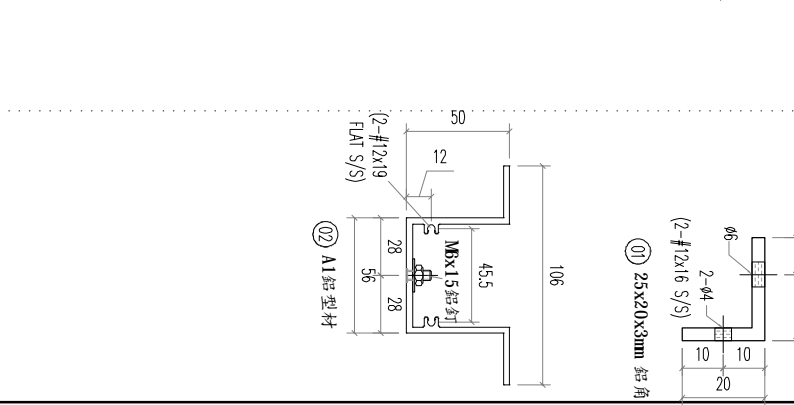
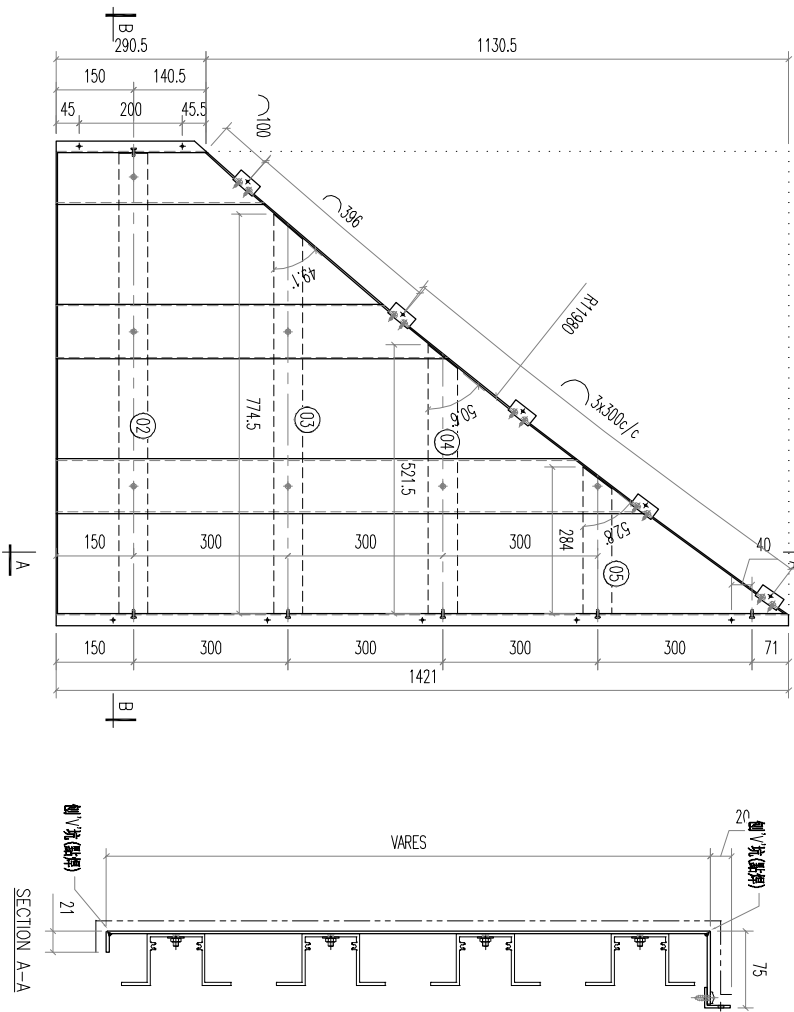
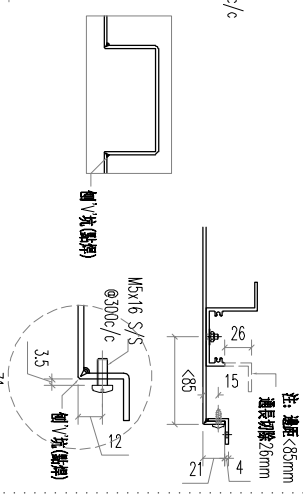
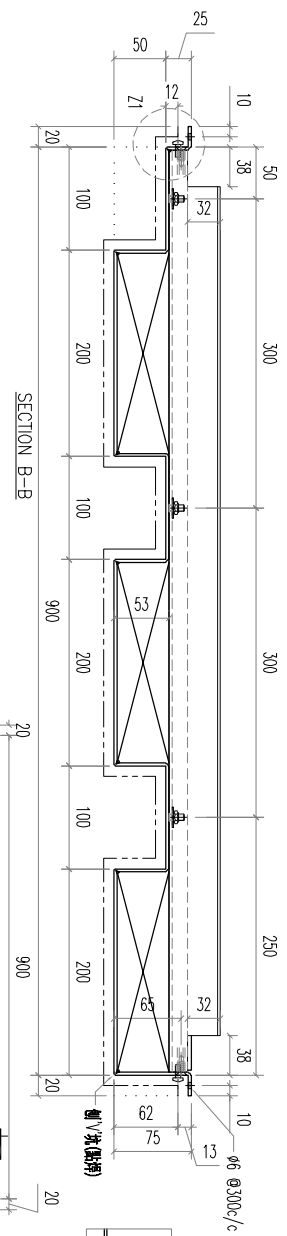

05	A1 鋁型材	284	開料	1	
04	A1 鋁型材	521.5	開料	1	
03	A1 鋁型材	774.5	開料	1	
02	A1 鋁型材	893	開料	1	
01	25X20X3mm 鋁角	50	開料	5	

序號	材料規格	長度	配件描述	數量	备注
05	A1 鋁型材	284	開料	1	
04	A1 鋁型材	521.5	開料	1	
03	A1 鋁型材	774.5	開料	1	
02	A1 鋁型材	893	開料	1	
01	25X20X3mm 鋁角	50	開料	5	

**美特鋁質有限公司**  
MIDI ALUMINIUM FABRICATOR LTD.  
Units 6-8, Sunray Industrial Centre, 1/F  
610 Cha Kwo Ling Road, Kowloon  
Tel: 23489211-4 Fax: (852) 2727666

PROJECT: J853-PODIUM ALUM CEILING & FEATURE CLADDING T7 7/F  
JOB NO.: J853  
DRAWING TITLE: 鋁板天花加工圖  
3mm THK. ALUM PLATE  
FACTORY: 01  
W/CENTRE: W/CENTRE  
M/CENTRE: M/CENTRE  
S/CENTRE: S/CENTRE  
FAB: FAB  
CUT ENDS: CUT ENDS  
FINISH: EC-DG-0334232-201 (AL1)  
DATE: 4/19/2023  
DRAWN: YEUNG  
SCALE: 1:5  
POST PAINT: PRE PAINT  
PART: SUB ASSEM.  
SHT. REV. S.....

REV.	CHECKED	PART NUMBER	Dim. A	Dim. B	Dim. C	Dim. D	Dim. E	Dim. F	Dim. G	QTY	Inv. Code	ASSEMBLE ON PARTS	EXTR. DRAWING
—	BAR BY	T7-CE02-09-05								2			PART DRAWING

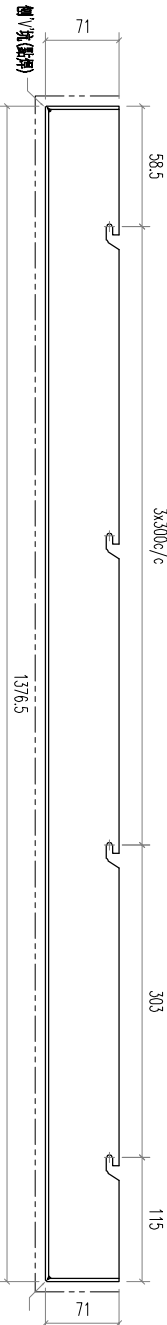

SECTION B-B

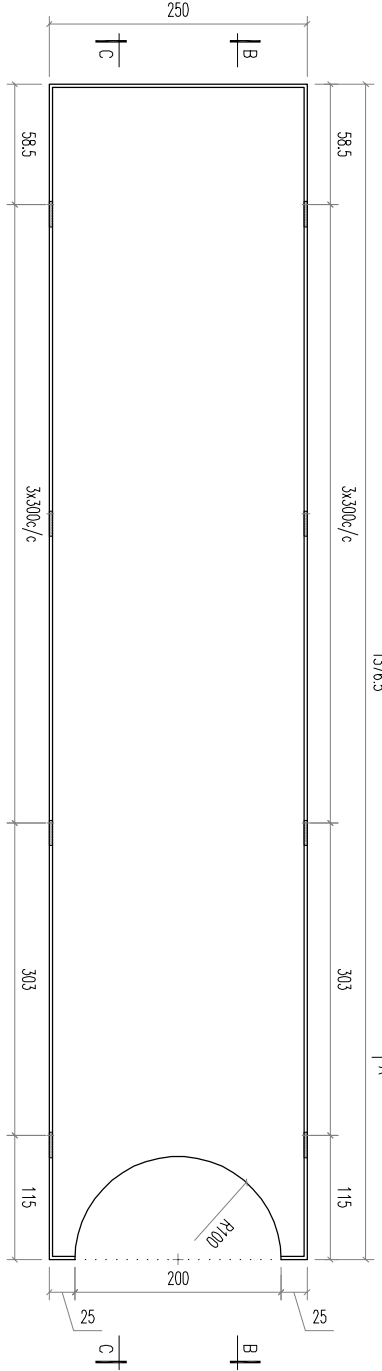
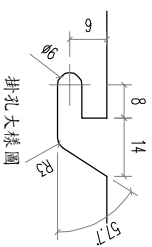

SECTION A-A

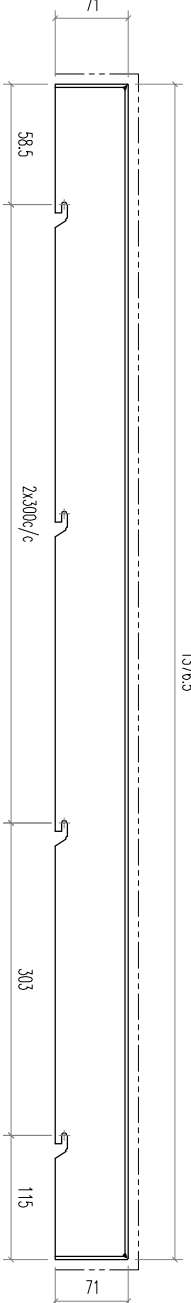

SECTION C-C

REV.	DATE	AMENDMENT	REVISED BY	<b>美特鋁質有限公司</b> MIDI ALUMINIUM FABRICATOR LTD. Units 6-8, Sunroy Industrial Centre, 1/F 610 Cho Kwo Ling Road, Kowloon Tel:23489211-4 Fax:(852)27727666				PROJECT	JOB NO.	DRAWING TITLE	FACTORY	W/CENTRE	CUT ENDS	FINISH	DRAWN	POST PAINT	PART		
				PROJECT J853-PODIUM ALUM CEILING & FEATURE CLADDING T7 7/F JOB NO. J853 DRAWING TITLE 鋁板天花加工圖 3mm THK. ALUM PLATE Standard X X . = ±1 Tolerances X X . X = ±05 Angle Squaredness ±1° DATE 4/19/2023 DRAWN YEUNG SCALE 1:5 PART SUB ASSEM. TRACK TYPE S.....				J853	鋁板天花加工圖 3mm THK. ALUM PLATE	01	MOCK/SCBA/FAB		噴漆 (Al6)		1:5				



REV.	CHECKED DATE BY	PART NUMBER	Dim. A	Dim. B	Dim. C	Dim. D	Dim. E	Dim. F	Dim. G	QTY	Inv. Code	ASSEMBLY ON PARTS	EXTR. DRAWING PART DRAWING
-		T7-CE02-02-06								1			

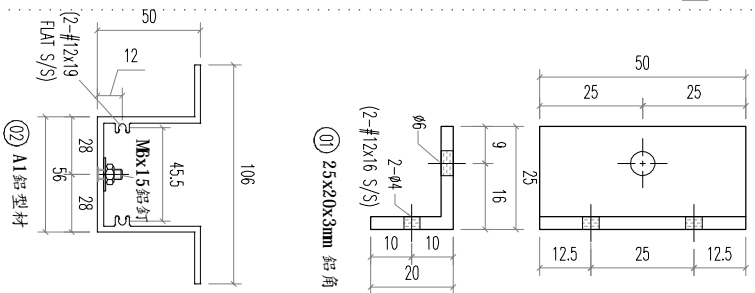
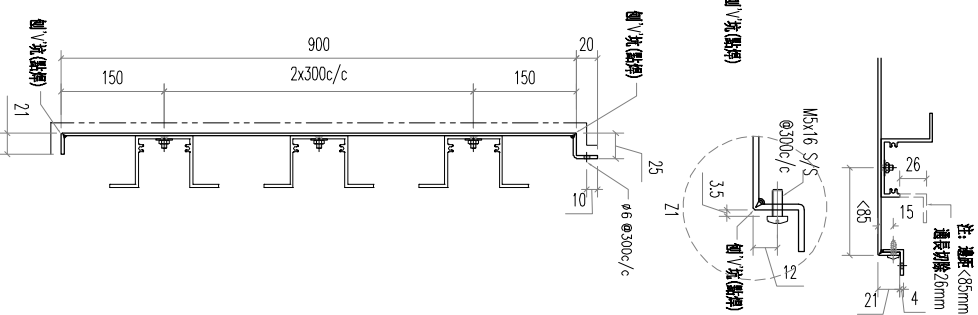
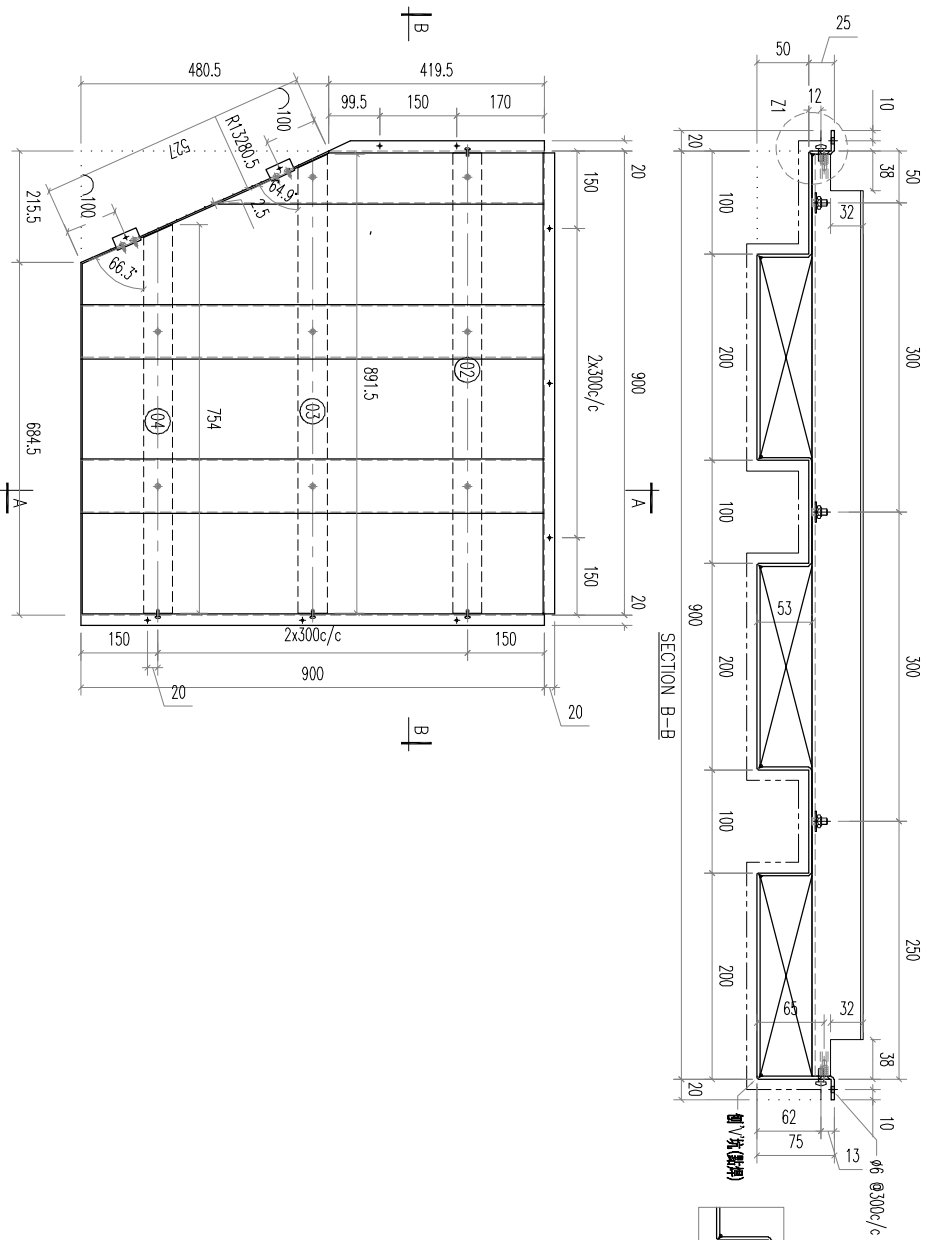

REV.	DATE	AMENDMENT	REVISED BY	REVISION
04		A1铝型材	754	开料 1
03		A1铝型材	891.5	开料 1
02		A1铝型材	893	开料 1
01		2.5X20X3mm 铝角	50	开料 2

序号	材料规格	长度	配件描述	数量	备注
04	A1铝型材	754	开料	1	
03	A1铝型材	891.5	开料	1	
02	A1铝型材	893	开料	1	
01	2.5X20X3mm 铝角	50	开料	2	

**美特铝质有限公司**  
MIDI ALUMINIUM FABRICATOR LTD.  
Units 6-8, Sunroy Industrial Centre, 1/F  
610 Cha Kwo Ling Road, Kowloon  
Tel:23489211-4 Fax:(852)27727666

PROJECT	J853-PODIUM ALUM CEILING & FEATURE CLADDING T7 7/F	JOB NO.	J853
FACTORY	01	W/CENTRE	W/CENTRE/SKID/FAB
Standard	X X . = ±1	CUT ENDS	Angle ±1°
Tolerances	X X . X = ±05	DATE	4/19/2023
		FINISH	EC-DG-0334232-201 (A1)
		DRAWN	YEUNG
		POST PAINT	SCALE 1:5
		PART	TRACK TYPE S.....
		SHT.	-/-
		REV.	-

DRAWING TITLE	铝板天花加工图 3mm THK. ALUM PLATE	DRAWING NO.	T7-CE02-02-06
DRAGING TITLE	铝板天花加工图 3mm THK. ALUM PLATE	DATE	4/19/2023
FACTORY	01	W/CENTRE	W/CENTRE/SKID/FAB
Standard	X X . = ±1	CUT ENDS	Angle ±1°
Tolerances	X X . X = ±05	DATE	4/19/2023
		FINISH	EC-DG-0334232-201 (A1)
		DRAWN	YEUNG
		POST PAINT	SCALE 1:5
		PART	TRACK TYPE S.....
		SHT.	-/-
		REV.	-

REV.	CHECKED DATE BY	PART NUMBER	Dim. A	Dim. B	Dim. C	Dim. D	Dim. E	Dim. F	Dim. G	QTY	Inv. Code	ASSEMBLE ON PARTS	EXTR. DRAWING PART DRAWING
1		T7-CE02-04-06								1			

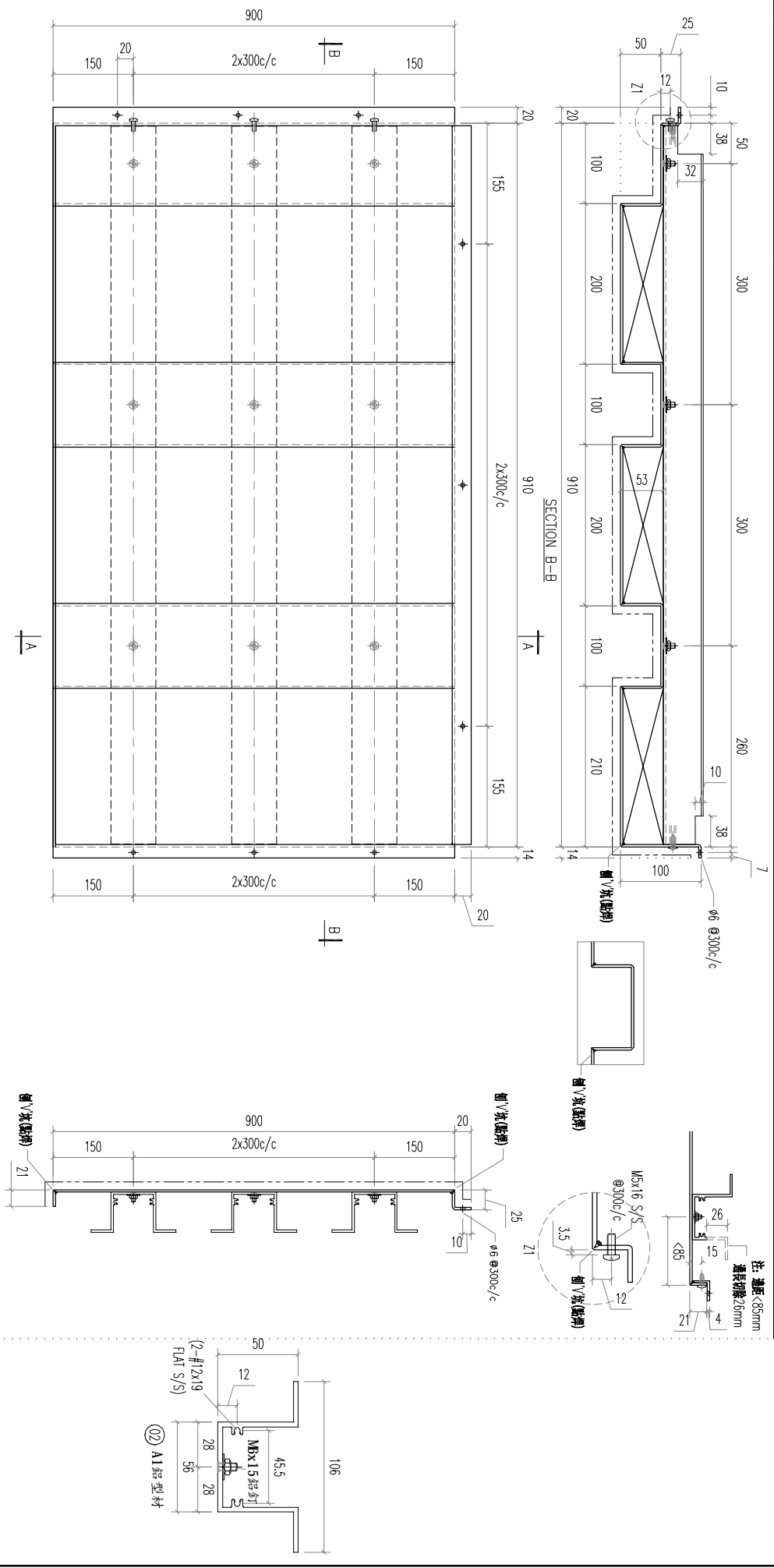

02	A1 鋁型材	903	開料	3	
REV.	材料規格	長度	配件描述	數量	备注
REV.	DATE	AMENDMENT	REVISED BY		
<p><b>美特鋁質有限公司</b>  <b>MIDI ALUMINIUM FABRICATOR LTD.</b>          Units 6-8, Sunroy Industrial Centre, 1/F          610 Cha Kwo Ling Road, Kowloon          Tel:23489211-4 Fax:(852)2727666</p> <p>PROJECT J853-PODIUM ALUM CEILING &amp; FEATURE CLADDING T7 7/F</p> <p>JOB NO. J853</p>					
FACTORY 01		W/CENTRE	CUT ENDS	FINISH	DATE
Standard X X . = ±1		W/CENTRE	Angle ±1°	EC-DG-0334232-201 (AL1)	4/19/2023
Tolerances X X . X = ±05		W/CENTRE	Squareness ±1°	DRAWN YEUNG	
DRAWING TITLE		DRAWING NO.		POST PAINT	PART
鋁板天花加工圖 3mm THK. ALUM PLATE		T7-CE02-04-06		SCALE 1:5	TRACK TYPE S.....
				SHT. -/-	REV. -

REV.	CHECKED DATE BY	PART NUMBER	Dim. A	Dim. B	Dim. C	Dim. D	Dim. E	Dim. F	Dim. G	QTY	Inv. Code	ASSEMBLE ON PARTS	EXTR. DRAWING PART DRAWING
-		T7-CE02-07-06								1			

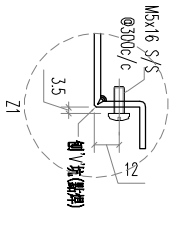
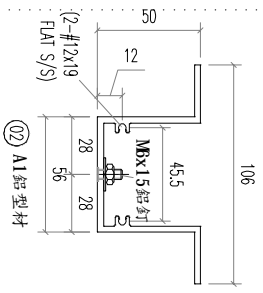
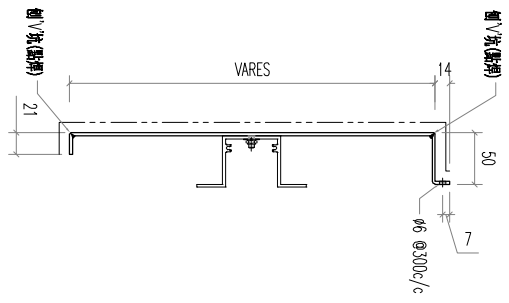
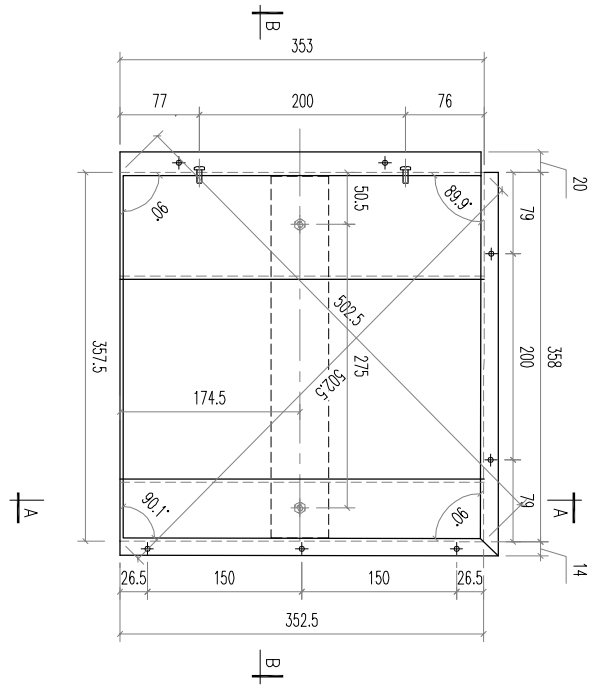
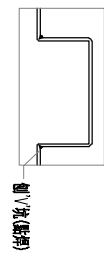
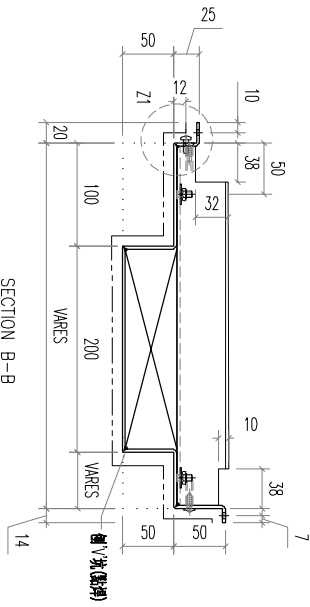

02	A1 鋁型材	351	開料	1	
序號	材料規格	長度	配件描述	數量	备注

美特鋁質有限公司  
MIDI ALUMINIUM FABRICATOR LTD.  
Units 6-8, Sunroy Industrial Centre, 1/F  
610 Cha Kwo Ling Road, Kowloon  
Tel: 23489211-4 Fax: (852) 27272666

PROJECT	J853-PODIUM ALUM CEILING & FEATURE CLADDING T7 7/F
JOB NO.	J853
FACTORY	01
W/CENTRE	W008/SK08/FAB
CUT ENDS	Angle ±1°
FINISH	EC-D6-0334232-201 (AL1)
DATE	4/19/2023
DRAWN	YEUNG
POST PAINT	PRE PAINT
SCALE	1:5
PART	SUB ASSEM.
SHT.	REV.

DRAWING TITLE	鋁板天花加工圖
DRAWING NO.	T7-CE02-07-06
DATE	
AMENDMENT	
REVISED BY	

REV.	CHECKED DATE BY	PART NUMBER	Dim. A	Dim. B	Dim. C	Dim. D	Dim. E	Dim. F	Dim. G	QTY	Inv. Code	ASSEMBLE ON PARTS	EXTR. DRAWING PART DRAWING
-		T7-CE02-08-06								1			

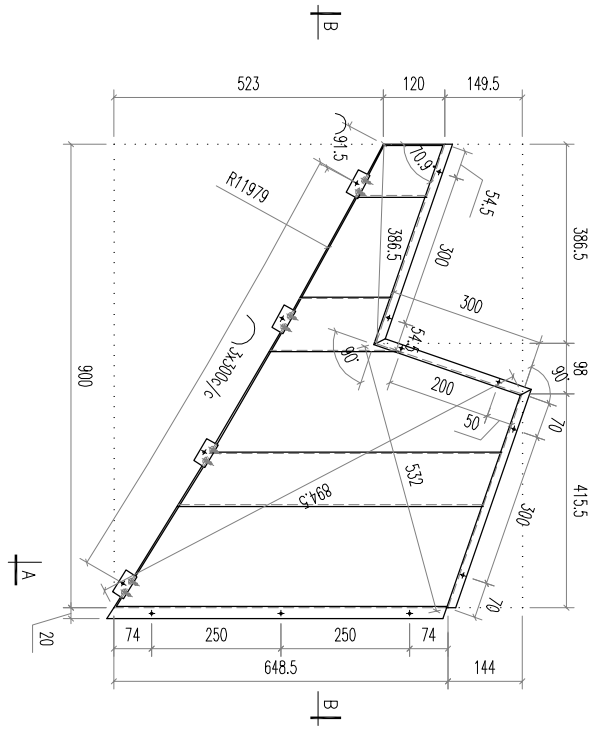
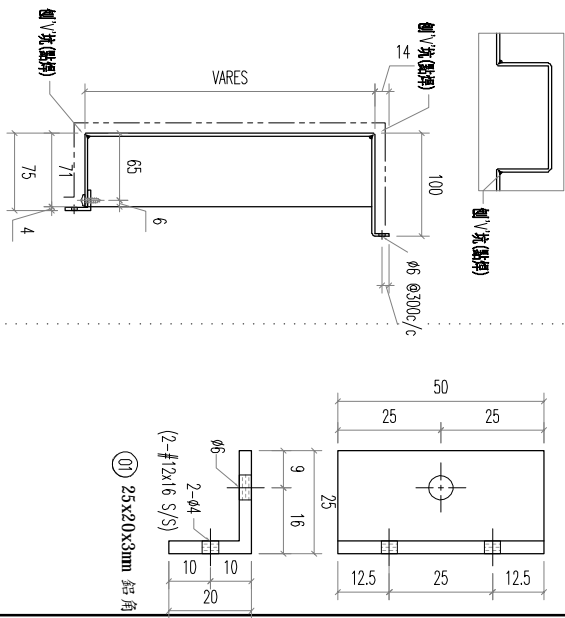
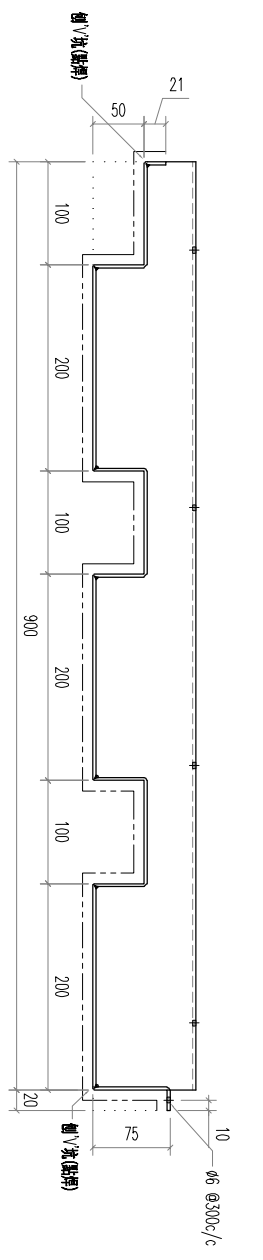

序号	材料规格	长度	开料	数量	备注
01	25x20x3mm 铝角	50	配件描述	4	

**美特铝质有限公司**  
MIDI ALUMINIUM FABRICATORS LTD.  
Units 6-8, Sunroy Industrial Centre, 1/F  
610 Cho Kwo Ling Road, Kowloon  
Tel: 23489211-4 Fax: (852) 27727666

REV.	DATE	AMENDMENT	REVISED BY	PROJECT J853-PODIUM ALUM CEILING & FEATURE CLADDING T7 7/F	JOB NO. J853	DRAWING TITLE 铝板天花加工图 3mm THK. ALUM PLATE	DRAWING NO. T7-CE02-08-06	SHT. -/-	REV.
------	------	-----------	------------	------------------------------------------------------------------	-----------------	-------------------------------------------------	------------------------------	-------------	------

REV.	CHECKED	PART NUMBER	Dim. A	Dim. B	Dim. C	Dim. D	Dim. E	Dim. F	Dim. G	QTY	Inv. Code	ASSEMBLE ON PARTS	EXTR. DRAWING
—	BAR BY	T7-CE02-09-06								1			PART DRAWING

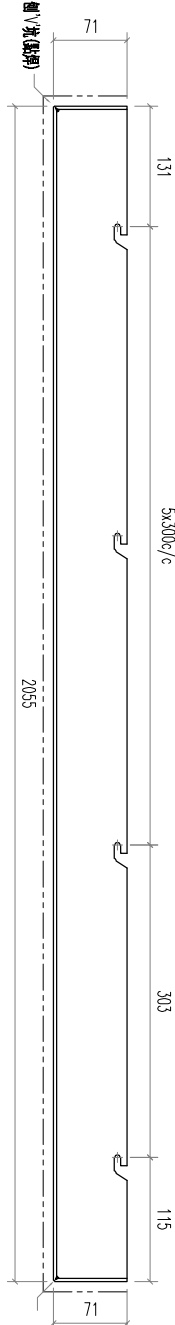

SECTION B-B

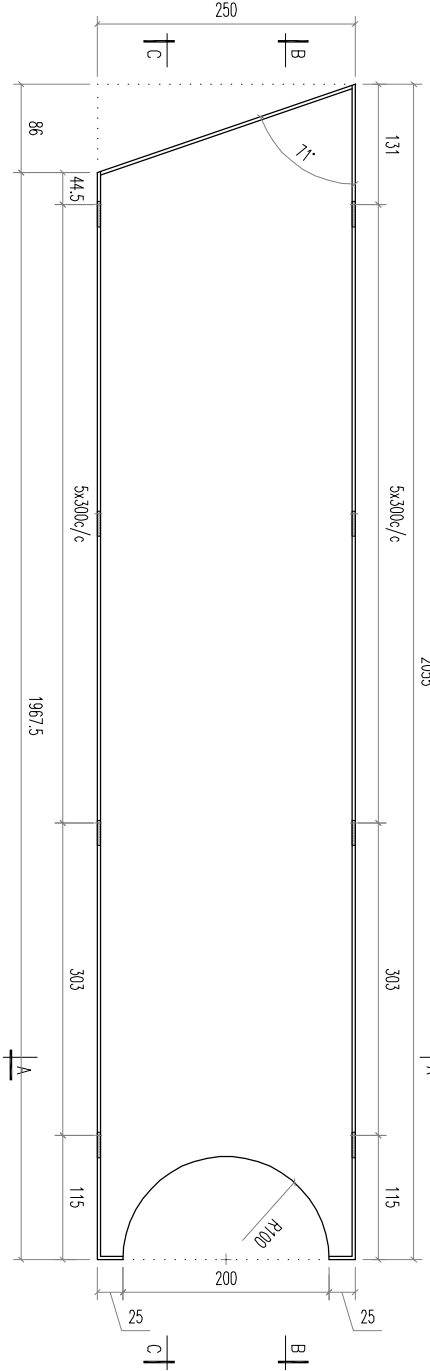

SECTION A-A

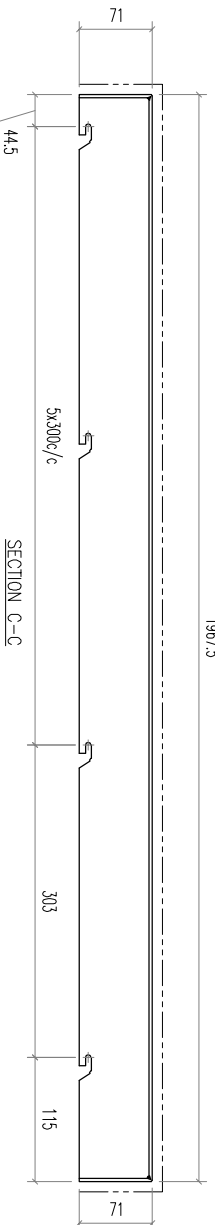

SECTION C-C

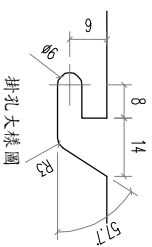

REV.	DATE	AMENDMENT	REVISED BY	 <b>美特鋁質有限公司</b> <b>MIDI ALUMINIUM FABRICATOR LTD.</b> Units 6-8, Sunroy Industrial Centre, 1/F 610 Cha Kwo Ling Road, Kowloon Tel: 23489211-4 Fax: (852) 27727666	PROJECT <b>J853-PODIUM ALUM CEILING</b> <b>&amp; FEATURE CLADDING T7 7/F</b>	JOB NO. J853	FACTORY 01 W/CENTRE MOCK/SKID/FAB CUT ENDS Standard X X . = ±1 Tolerances X X . X = ±05 Angle Squariness ±1°	FINISH DATE 4/19/2023	DRAWING TITLE <b>鋁板天花加工圖</b> <b>3mm THK. ALUM PLATE</b>	DRAWING NO. T7-CE02-09-06	POST PAINT SCALE 1:5	PART SUB ASSEM. TRACK TYPE S.....	SHT. -/-	REV. -
------	------	-----------	------------	-----------------------------------------------------------------------------------------------------------------------------------------------------------------------------------------------------------------------------------------------------------------	------------------------------------------------------------------------------------	-----------------	-----------------------------------------------------------------------------------------------------------------------------------	-----------------------------	---------------------------------------------------------------	------------------------------	----------------------------	--------------------------------------------	-------------	-----------

REV.	CHECKED	PART NUMBER	Dim. A	Dim. B	Dim. C	Dim. D	Dim. E	Dim. F	Dim. G	QTY	Inv. Code	EXTR. DRAWING
-	BAR BY	T7-CE02-01-07								1		PART DRAWING

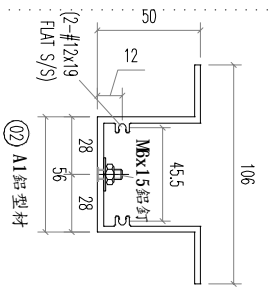
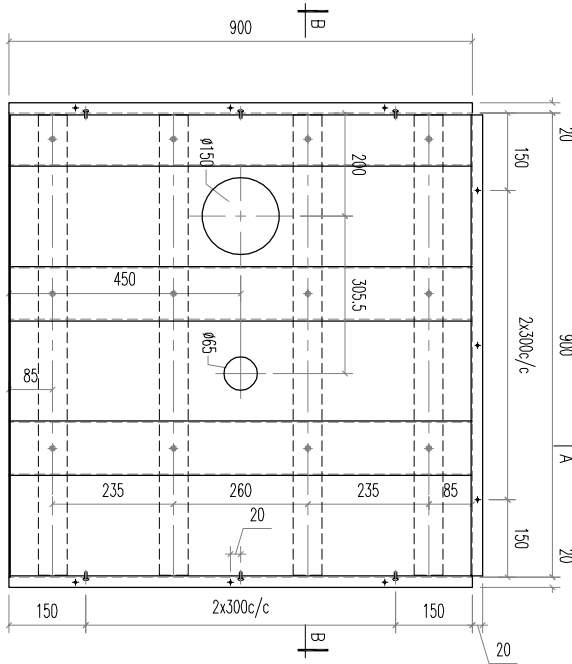
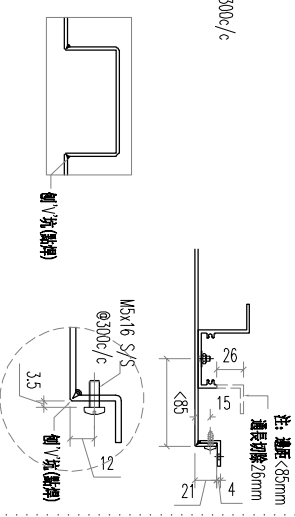
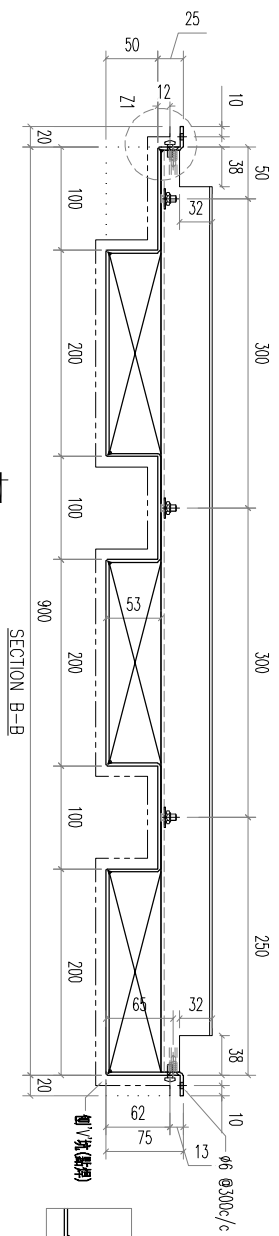

SECTION A-A

SECTION B-B

02	A1 铝型材	893	开料	4	
REV.	材料规格	长度	配件描述	数量	备注

**美特铝质有限公司**  
**MIDI ALUMINIUM FABRICATOR LTD.**  
 Units 6-8, Sunray Industrial Centre, 1/F  
 610 Cho Kwo Ling Road, Kowloon  
 Tel:23489211-4 Fax:(852)27727666

PROJECT J853-PODIUM ALUM CEILING  
 & FEATURE CLADDING T7 7/F

JOB NO. J853

FACTORY	W/CENTRE	CUT ENDS	FINISH	DATE
01	MBX6/SKBA/FAB	Angle ±1°	EC-DG-0334232-201 (AL1)	4/19/2023
Standard	X X . X = ±1	Squareness ±1°		
Tolerances	X X . X = ±05			

DRAWING TITLE	DRAWN	SCALE	POST PAINT	PART
铝板天花加工图 3mm THK. ALUM PLATE	YEUNG	1:5	PRE PAINT	SUB ASSEM.
DRAWING NO. T7-CE02-01-07				TRACK TYPE S.....
				SHT. -/-
				REV. -

REV.	CHECKED DATE BY	PART NUMBER	Dim. A	Dim. B	Dim. C	Dim. D	Dim. E	Dim. F	Dim. G	QTY	Inv. Code	ASSEMBLE ON PARTS	EXTR. DRAWING PART DRAWING
-		T7-CE02-02-07								1			

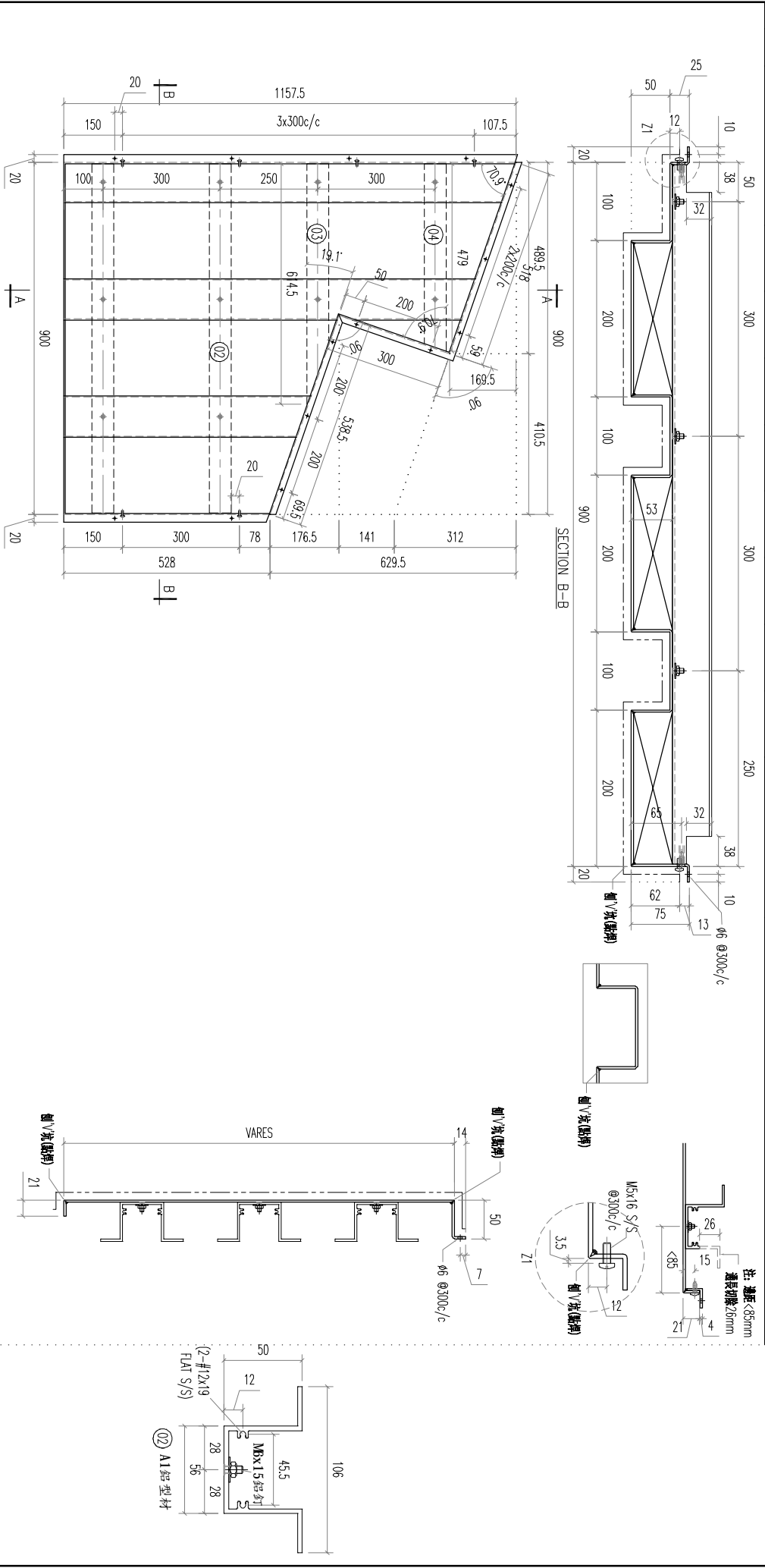

REV.	DATE	AMENDMENT	REVISED BY
04		A1 鋁型材	
03		A1 鋁型材	
02		A1 鋁型材	

序号	材料规格	长度	配件描述	数量	备注
04	A1 鋁型材	479	开料	1	
03	A1 鋁型材	614.5	开料	1	
02	A1 鋁型材	893	开料	2	

**美特 鋁質有限公司**  
**MIDI ALUMINIUM FABRICATOR LTD.**  
 Units 6-8, Sunroy Industrial Centre, 1/F  
 610 Cho Kwo Ling Road, Kowloon  
 Tel: 23489211-4 Fax: (852) 27727666

PROJECT	J853-PODIUM ALUM CEILING & FEATURE CLADDING T7 7/F	JOB NO.	J853	DRAWING TITLE	鋁板天花加工圖 3mm THK. ALUM PLATE	DRAWING NO.	T7-CE02-02-07	SHT.	-/-	REV.	-
FACTORY	01	W/CENTRE	MAX/SCBA/FAB	CUT ENDS		FINISH	EC-DG-0334232-201 (AL1)	POST PAINT		PART	
Standard	X X .	= ±1	Angle	±1°	DATE	4/19/2023	DRAWN	YEUNG	SCALE	1:5	SUB ASSEM.
Tolerances	X X . X = ±0.5	Squareness	±1°								TRACK TYPE
											S.....

REV.	CHECKED DATE BY	PART NUMBER	Dim. A	Dim. B	Dim. C	Dim. D	Dim. E	Dim. F	Dim. G	QTY	Inv. Code	ASSEMBLE ON PARTS	EXTR. DRAWING PART DRAWING
-		T7-CE02-04-07								1			

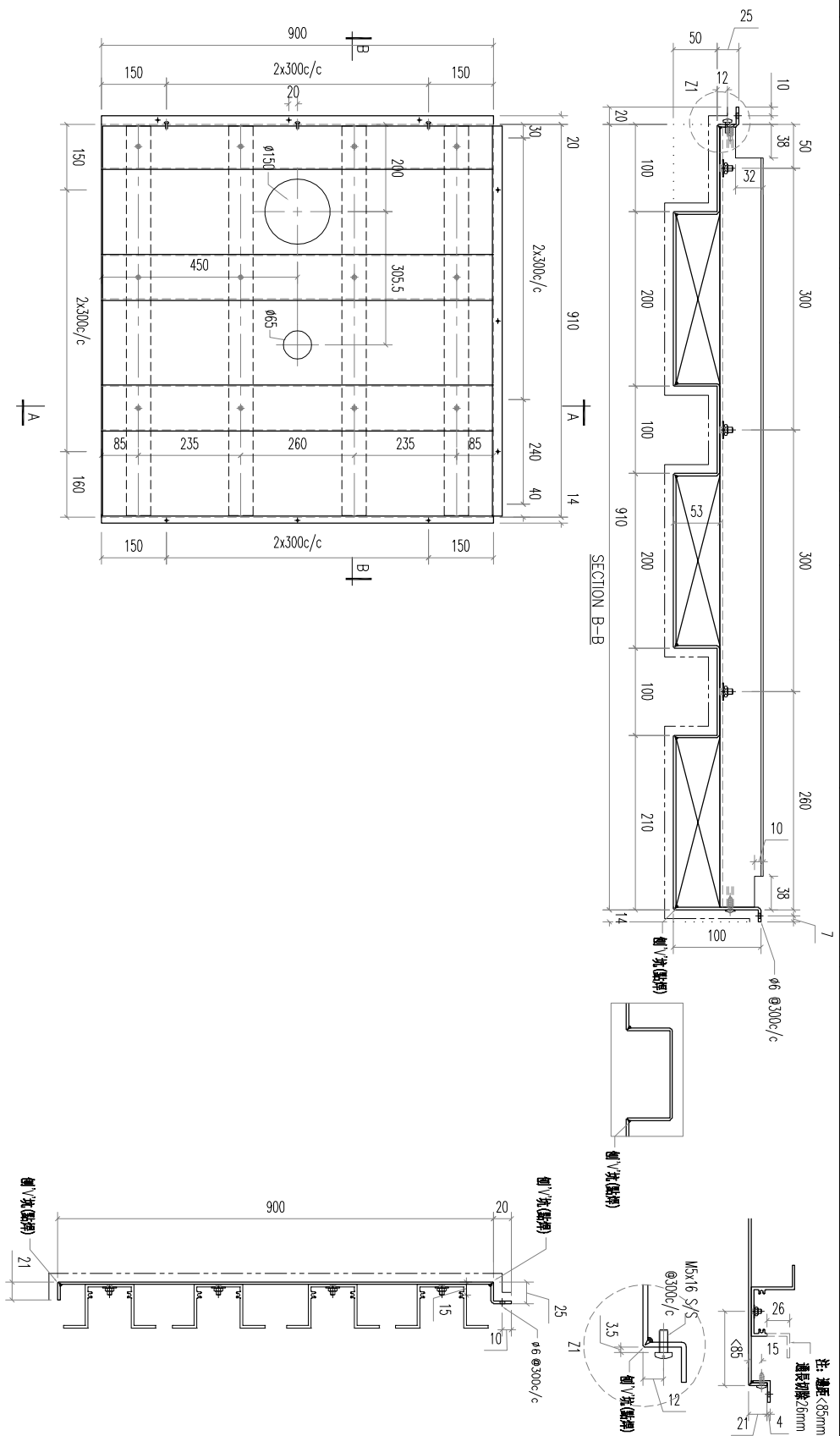

SECTION A-A

SECTION B-B

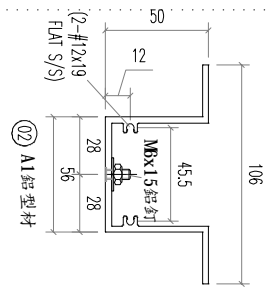

② A1鋁型材

02	A1鋁型材	903	開料	4	
REV	DATE	AMENDMENT	REVISED BY		
<p>材料規格 長度 配件描述 數量 备注</p>					
<p>UNITED MIDD ALUMINIUM FABRICATOR LTD. Units 6-8, Sunroy Industrial Centre, 1/F 610 Cho Kwo Ling Road, Kowloon Tel:23489211-4 Fax:(852)2727666</p>					
<p>PROJECT J853-PODIUM ALUM CEILING &amp; FEATURE CLADDING T7 7/F</p>					
<p>JOB NO. J853</p>					
<p>FACTORY 01 W/CENTRE MB06/SK06/FAB CUT ENDS</p>					
<p>Standard X X . = ±1 Angle ±1°</p>					
<p>Tolerances X X . X = ±05 Squariness ±1°</p>					
<p>FINISH EC-DG-0334232-201 (AL1) 噴漆</p>					
<p>DATE 4/19/2023</p>					
<p>DRAWN YEUNG</p>					
<p>DRAWING NO. T7-CE02-04-07</p>					
<p>POST PAINT PRE PAINT SCALE 1:5</p>					
<p>PART SUB ASSEM. TRACK TYPE S.....</p>					
<p>SHT. -/-</p>					
<p>REV. -</p>					

REV.	CHECKED DATE	PART NUMBER	Dim. A	Dim. B	Dim. C	Dim. D	Dim. E	Dim. F	Dim. G	QTY	Inv. Code	ASSEMBLY ON PARTS	EXTR. DRAWING PART DRAWING
-		T7-CE02-08-07								1			

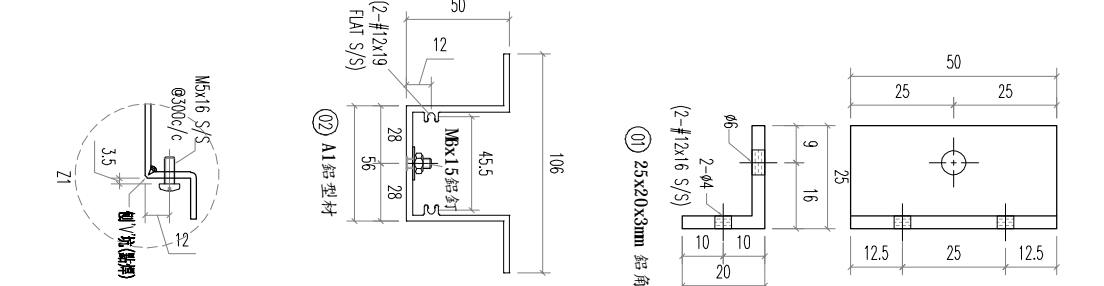
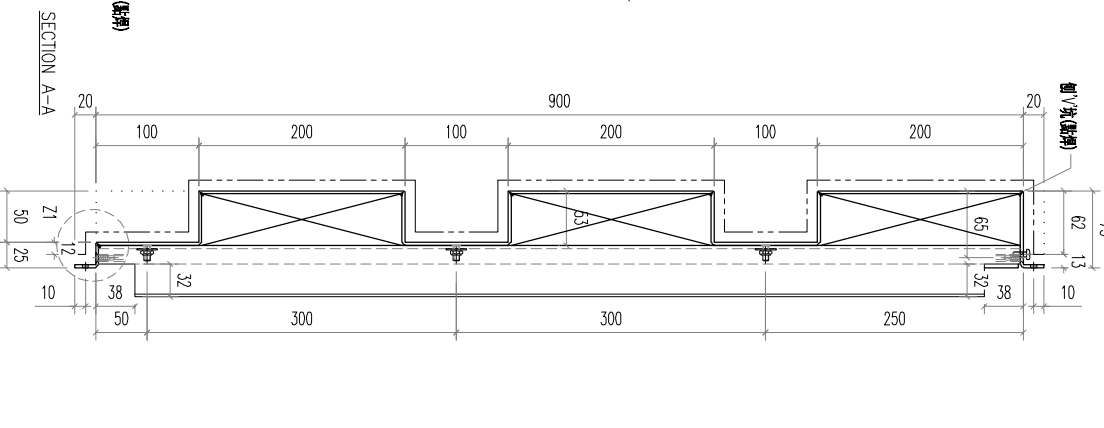
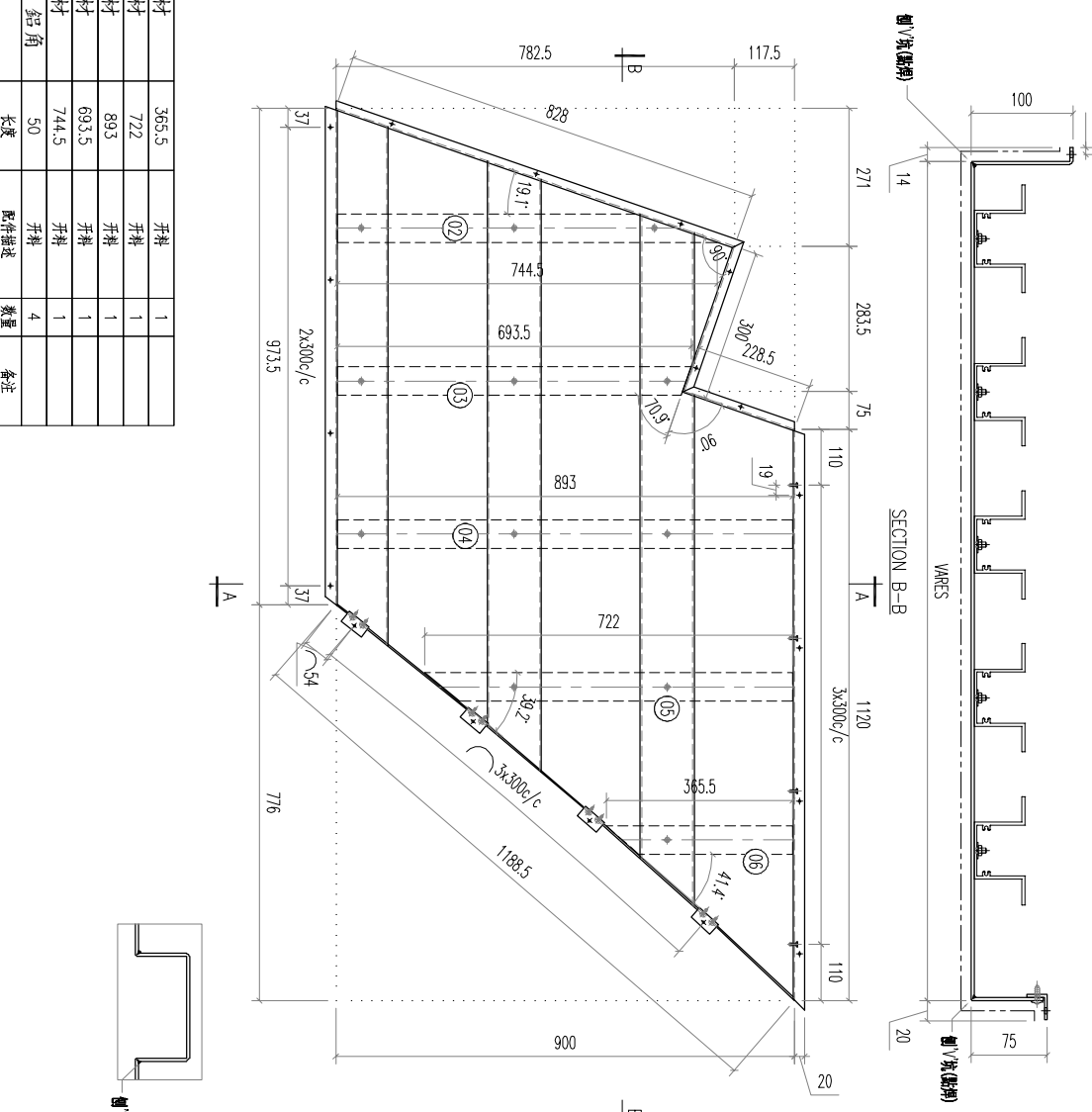

REV	DATE	AMENDMENT	REVISED BY			
06		A1 鋁型材	365.5	開梯	1	
05		A1 鋁型材	722	開梯	1	
04		A1 鋁型材	893	開梯	1	
03		A1 鋁型材	693.5	開梯	1	
02		A1 鋁型材	744.5	開梯	1	
01		25x20x3mm 鋁角	50	開梯	4	

序號	材料規格	長度	配件描述	數量	备注
06	A1 鋁型材	365.5	開梯	1	
05	A1 鋁型材	722	開梯	1	
04	A1 鋁型材	893	開梯	1	
03	A1 鋁型材	693.5	開梯	1	
02	A1 鋁型材	744.5	開梯	1	
01	25x20x3mm 鋁角	50	開梯	4	

FACTORY	W/CENTRE	CUT ENDS	FINISH	DATE	DRAWN	SCALE	POST PAINT	PART
01	W/CENTRE	SKDBA/FAB	EC-DG-0334232-201 (A1)	4/19/2023	YEUNG	1:5	PRE PAINT	SUB ASSEM.
Standard	X X . = ±1	Angle	±1'					TRACK TYPE
Tolerances	X X . X = ±05	Squareness	±1'					S.....

**美特鋁質有限公司**  
**MIDI ALUMINIUM FABRICATOR LTD.**  
 Units 6-8, Sunroy Industrial Centre, 1/F  
 610 Cho Kwo Ling Road, Kowloon  
 Tel:23489211-4 Fax:(852)2727666

PROJECT: J853-PODIUM ALUM CEILING & FEATURE CLADDING T7 7/F  
 JOB NO. J853  
 DRAWING TITLE: 鋁板天花加工圖  
 3mm THK. ALUM PLATE  
 DRAWING NO. T7-CE02-08-07





REV.	CHECKED BY	PART NUMBER	Dim. A	Dim. B	Dim. C	Dim. D	Dim. E	Dim. F	Dim. G	QTY	Inv. Code	ASSEMBLE ON PARTS	EXTR. DRAWING PART DRAWING
1		T7-CE02-08-08								1			
序号	材料规格	长度	配件描述	数量	备注								
01	2.5x20x3mm 铝角	50	开槽	6									
02	A1 铝型材	893	开槽	1									
03	A1 铝型材	845	开槽	1									
04	A1 铝型材	604	开槽	1									
05	A1 铝型材	340.5	开槽	1									

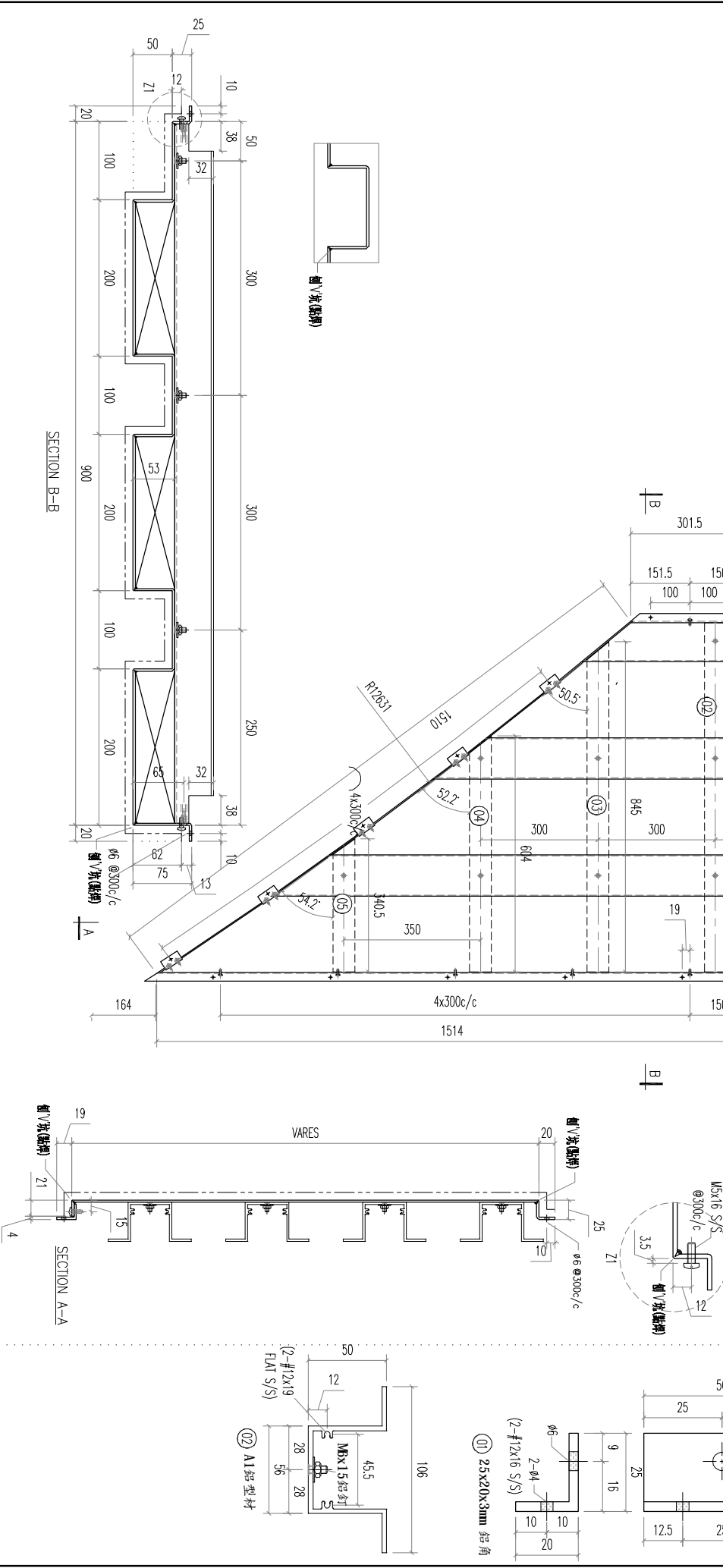

REV.	DATE	AMENDMENT	REVISED BY	PROJECT	JOB NO.	DRAWING TITLE	FACTORY	W/CENTRE	CUT ENDS	FINISH	DATE	DRAWN	SCALE	POST PAINT	PART	SHT.	REV.
				853-PODIUM ALUM CEILING & FEATURE CLADDING T7 7/F	J853	铝板天花加工图 3mm THK. ALUM PLATE	01	W/CENTRE MAX/SKBA/FAB	CUT ENDS	EC-DG-0334232-201 (A1)	4/19/2023	YEUNG	1:5			-/-	-
<p><b>美特铝质有限公司</b> MIDI ALUMINIUM FABRICATORS LTD. Units 6-8, Sunroy Industrial Centre, 1/F 610 Cho Kwo Ling Road, Kowloon Tel:23489211-4 Fax:(852)27727666</p>																	



REV.	CHECKED	PART NUMBER	Dim. A	Dim. B	Dim. C	Dim. D	Dim. E	Dim. F	Dim. G	QTY	Inv. Code	ASSEMBLE ON PARTS	EXTR. DRAWING
1	BAR BY	T7-CE02-11-01								26			PART DRAWING

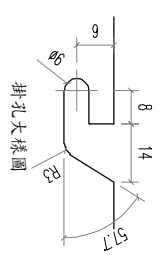
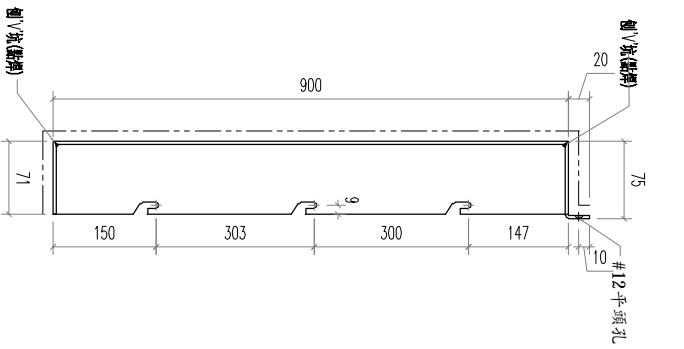
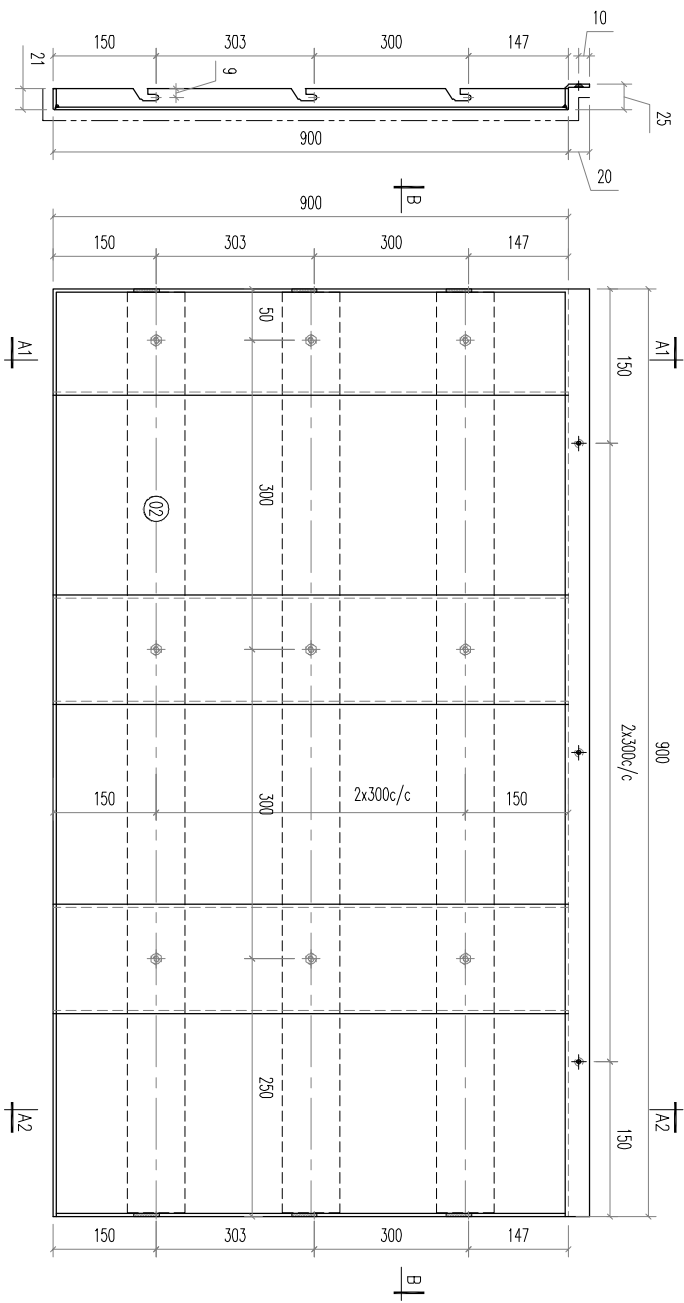
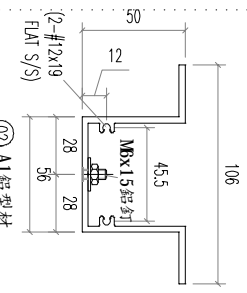
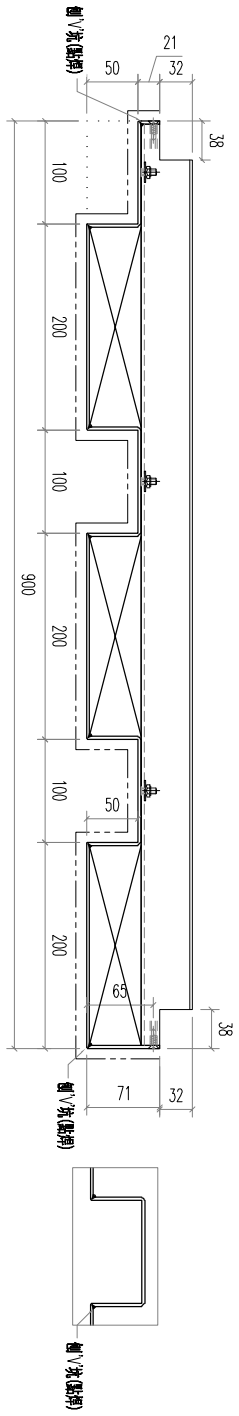

02	A1 鋁型材	893	開料	3	
REV.	材料規格	長度	配件描述	數量	备注
REV.	DATE	AMENDMENT	REVISED BY		
<p>UNITED MIDD ALUMINIUM FABRICATOR LTD.</p> <p>美特鋁質有限公司</p> <p>Units 6-8, Sunroy Industrial Centre, 1/F 610 Cho Kwo Ling Road, Kowloon Tel: 23489211-4 Fax: (852) 27727666</p> <p>PROJECT J853-PODIUM ALUM CEILING &amp; FEATURE CLADDING T7 7/F</p> <p>JOB NO. J853</p> <p>FACTORY 01 W/CENTRE MBX/SCBA/FAB CUT ENDS Standard X X . X = ±1 Angle ±1' DATE 4/19/2023</p> <p>FINISH EC-DG-0334232-201 (AL1) 噴漆</p> <p>DRAWING TITLE 鋁板天花加工圖 3mm THK. ALUM PLATE</p> <p>DRAWING NO. T7-CE02-11-01</p> <p>POST PAINT PRE PAINT SCALE 1:5</p> <p>PART TRACK TYPE S.....</p> <p>SHT. -/-</p> <p>REV. -</p>					

REV.	CHECKED DATE	PART NUMBER	Dim. A	Dim. B	Dim. C	Dim. D	Dim. E	Dim. F	Dim. G	QTY	Inv. Code	ASSEMBLE ON PARTS	EXTR. DRAWING PART DRAWING
-		T7-CE02-12-01								1			

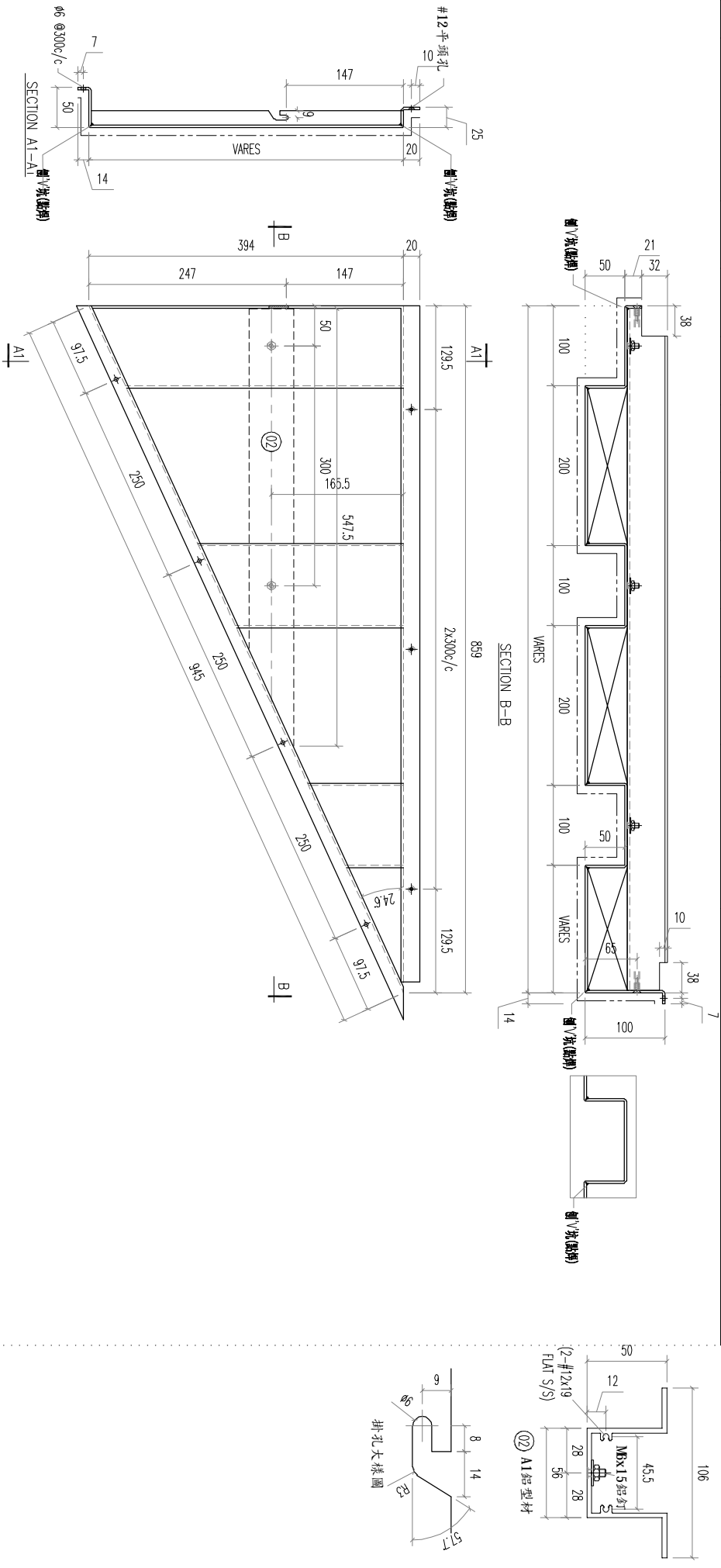

02	A1 鋁型材	547.5	開料	1	
序號	材料規格	長度	配件描述	數量	备注

**美特鋁質有限公司**  
MIDI ALUMINIUM FABRICATOR LTD.

Units 6-8, Sunray Industrial Centre, 1/F  
610 Cho Kwo Ling Road, Kowloon  
Tel: 23489211-4 Fax: (852) 27727666

PROJECT J853-PODIUM ALUM CEILING  
& FEATURE CLADDING T7 7/F

JOB NO. J853

FACTORY	W/CENTRE	CUT ENDS	FINISH
01	MARK/SKID/FAB		EC-D6-0334232-201 (AL1)
Standard	X X . = ±1	Angle	DATE
Tolerances	X X . X = ±05	Squareness ±1'	4/19/2023

DRAWING TITLE: 鋁板天花加工圖  
3mm THK. ALUM PLATE

DRAWING NO.	POST PAINT	PART
T7-CE02-12-01	PRE PAINT	SUB ASSEM.
	SCALE	TRACK TYPE
	1:5	S.....
SHT.		REV.
-/-		-



REV.	CHECKED DATE BY	PART NUMBER	Dim. A	Dim. B	Dim. C	Dim. D	Dim. E	Dim. F	Dim. G	QTY	Inv. Code	ASSEMBLE ON PARTS	EXTR. DRAWING PART DRAWING
-		T7-CE02-12-03								1			

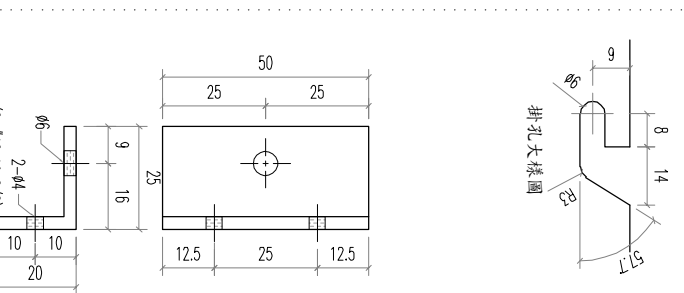
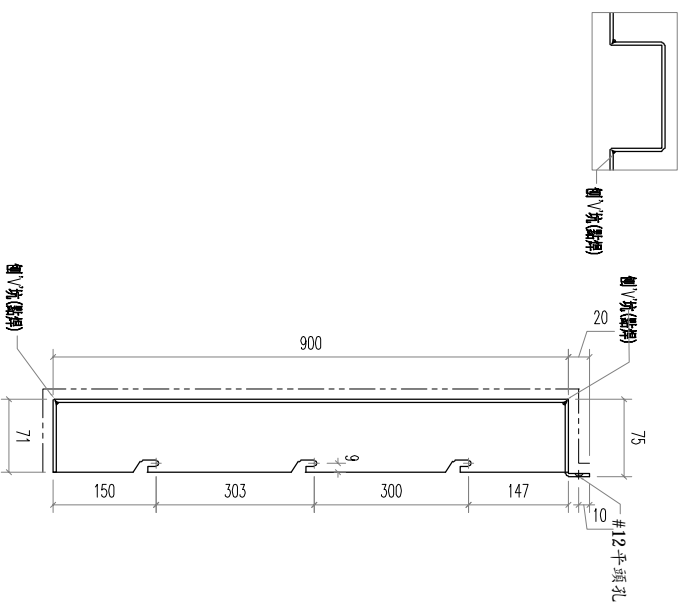
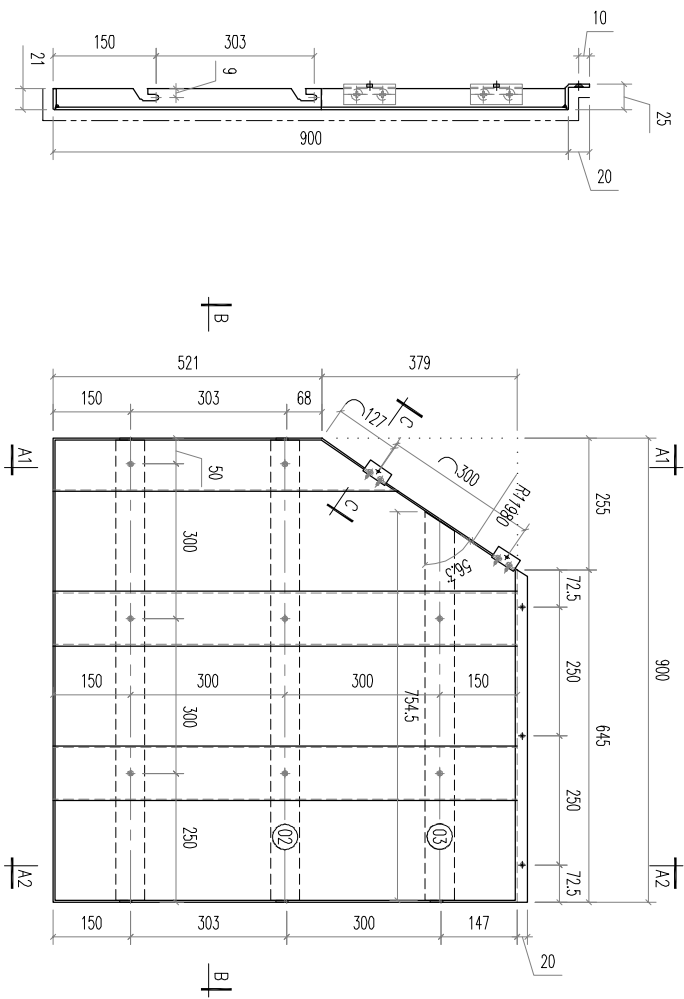
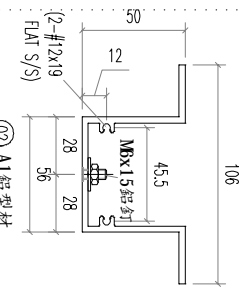
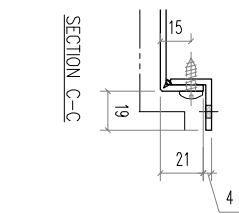
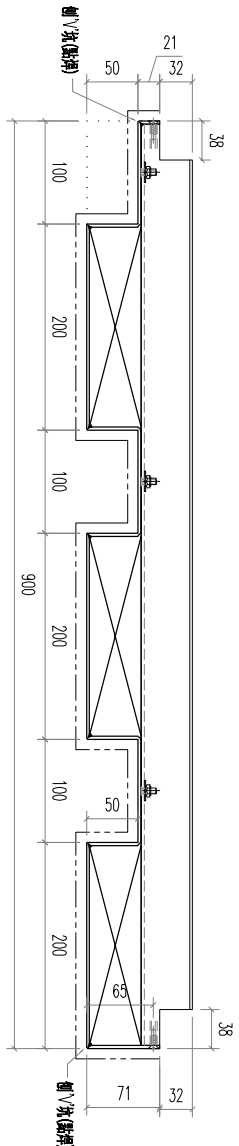

REV.	DATE	AMENDMENT	REVISED BY
03		A1 鋁型材	754.5
02		A1 鋁型材	893
01		2.5X20X3mm 鋁角	50

序號	材料規格	長度	配件描述	數量	备注

FACTORY	W/CENTRE	CUT ENDS	FINISH	POST PAINT	PART
01	MAX/SCBA/FAB		EC-DG-0334232-201 (AL1)		

**美特鋁質有限公司**  
MIDI ALUMINIUM FABRICATOR LTD.  
Units 6-8, Sunray Industrial Centre, 1/F  
610 Cho Kwo Ling Road, Kowloon  
Tel: 23489211-4 Fax: (852) 27727666

REV.	DATE	AMENDMENT	REVISED BY	PROJECT	JOB NO.	DRAWING TITLE	DRAWING NO.	SHT.	REV.
				J853-PODIUM ALUM CEILING & FEATURE CLADDING T7 7/F	J853	鋁板天花加工圖 3mm THK. ALUM. PLATE	T7-CE02-12-03	-/-	-

REV.	CHECKED BAR BY	PART NUMBER	Dim. A	Dim. B	Dim. C	Dim. D	Dim. E	Dim. F	Dim. G	QTY	Inv. Code	ASSEMBLE ON PARTS	EXTR. DRAWING PART DRAWING
-		T7-CE02-12-04								1			

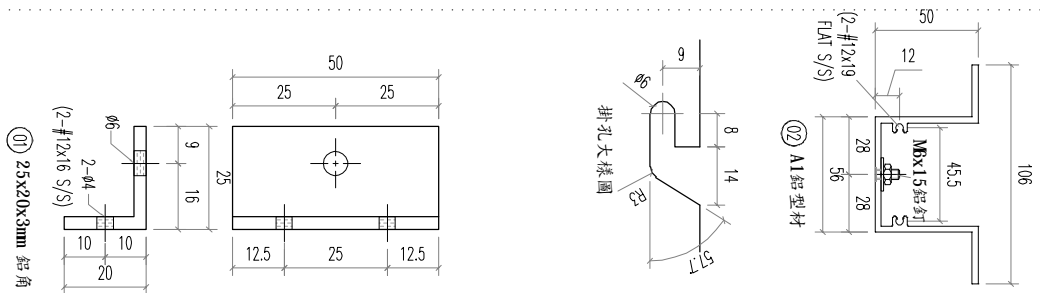
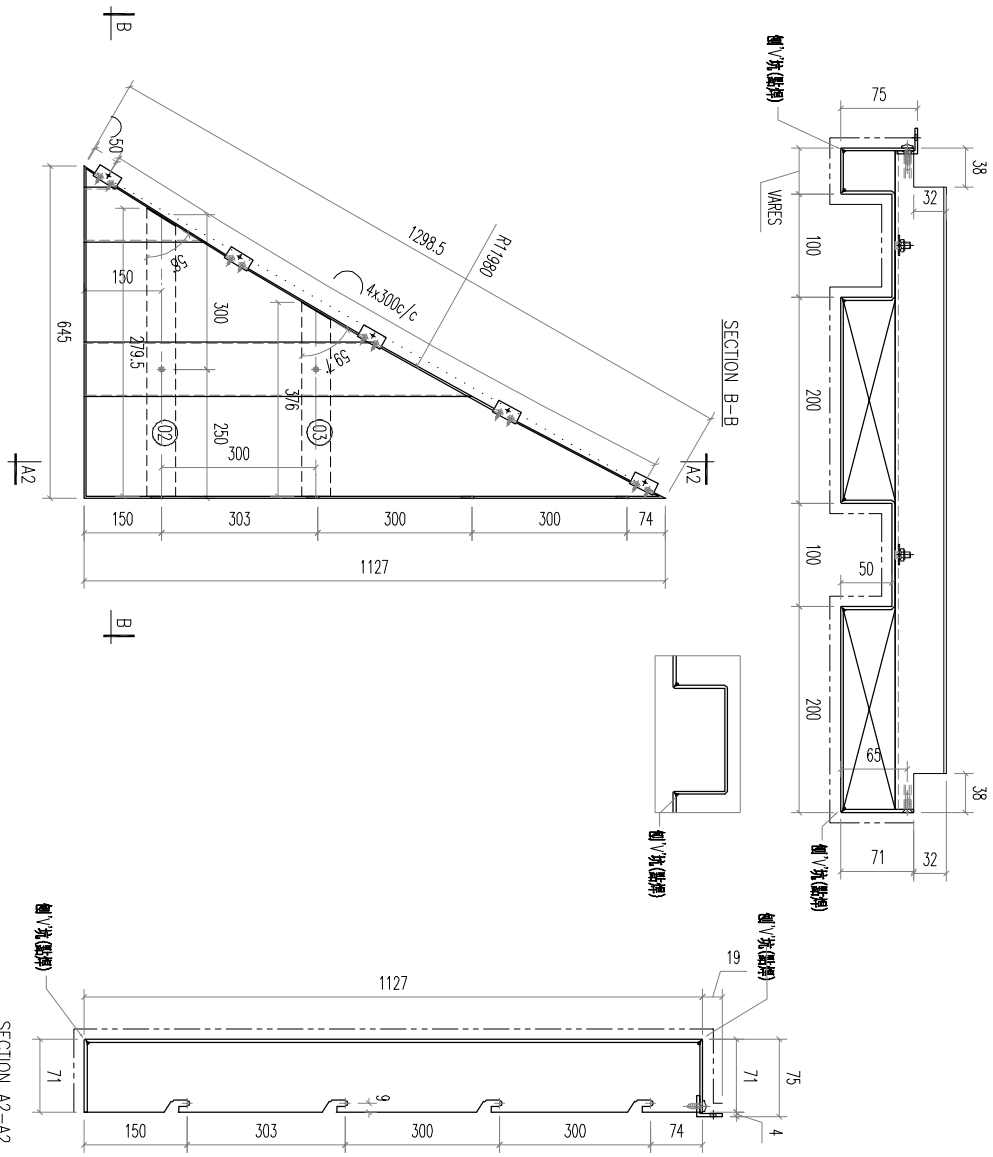

03	A1 鋁型材	376	開料	1	
02	A1 鋁型材	279.5	開料	1	
01	25x20x3mm 鋁角	50	開料	5	
序號	材料規格	長度	配件描述	數量	备注

**美特鋁質有限公司**  
MIDI ALUMINIUM FABRICATOR LTD.  
Units 6-8, Sunray Industrial Centre, 1/F  
610 Cho Kwo Ling Road, Kowloon  
Tel: 23489211-4 Fax: (852) 27727666

REV.	DATE	AMENDMENT	REVISED BY	PROJECT J853-PODIUM ALUM CEILING & FEATURE CLADDING T7 7/F	JOB NO. J853	DRAWING TITLE 鋁板天花加工圖 3mm THK. ALUM. PLATE	DRAWING NO. T7-CE02-12-04	POST PAINT PRE PAINT	PART SUB ASSEM.	SHT. REV.

REV.	CHECKED DATE BY	PART NUMBER	Dim. A	Dim. B	Dim. C	Dim. D	Dim. E	Dim. F	Dim. G	QTY	Inv. Code	ASSEMBLE ON PARTS	EXTR. DRAWING PART DRAWING
-		T7-CE02-12-05								1			

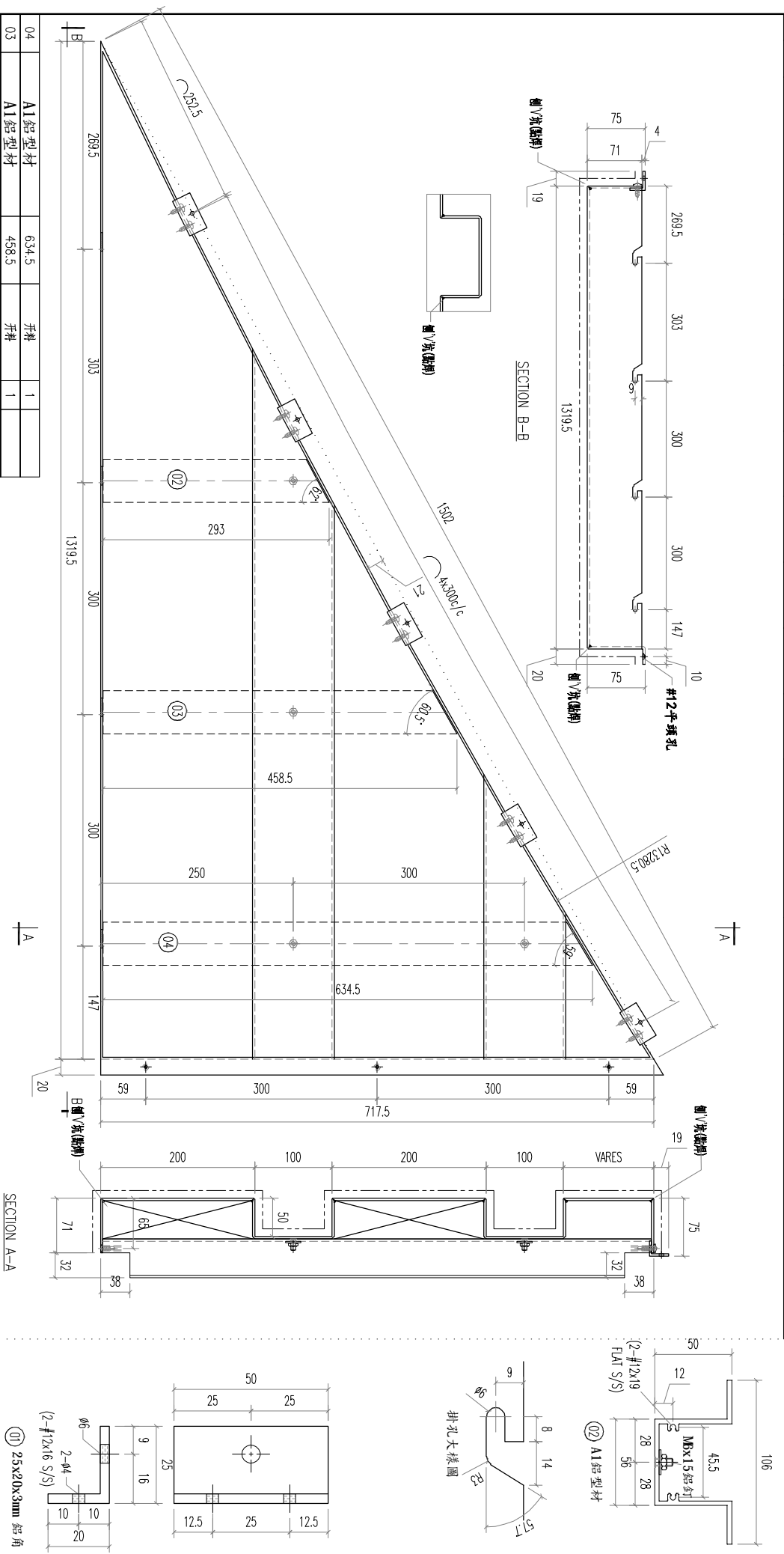

序号	材料规格	长度	配件描述	数量	备注
01	25x20x3mm 鋁角	50	开料	5	
02	A1 鋁型材	293	开料	1	
03	A1 鋁型材	458.5	开料	1	
04	A1 鋁型材	634.5	开料	1	

REV.	DATE	AMENDMENT	REVISED BY

**美特鋁質有限公司**  
MIDI ALUMINIUM FABRICATOR LTD.  
Units 6-8, Sunroy Industrial Centre, 1/F  
610 Cha Kwo Ling Road, Kowloon  
Tel:23489211-4 Fax:(852)27727666

PROJECT J853-PODIUM ALUM CEILING  
& FEATURE CLADDING T7 7/F  
JOB NO. J853

FACTORY	W/CENTRE	CUT ENDS	FINISH
01	MAX/SKBA/FAB	Angle	EC-DG-0334232-201 (AL1)

DATE	DRAWN	SCALE	POST PAINT	PART
4/19/2023	YEUNG	1:5		

DATE	AMENDMENT	REVISED BY	DRAWING TITLE	DRAWING NO.	SHT.	REV.
			鋁板天花加工圖 3mm THK. ALUM PLATE	T7-CE02-12-05	-/-	-

REV. CHECKED BY	PART NUMBER	Dim. A	Dim. B	Dim. C	Dim. D	Dim. E	Dim. F	Dim. G	QTY	Inv. Code	ASSEMBLE ON PARTS	EXTR. DRAWING PART DRAWING
-	T7-CE02-12-06								1			

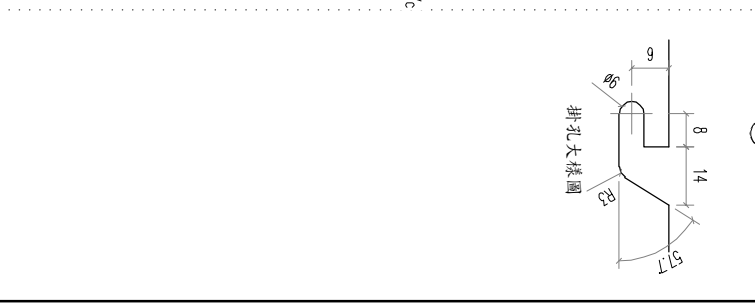
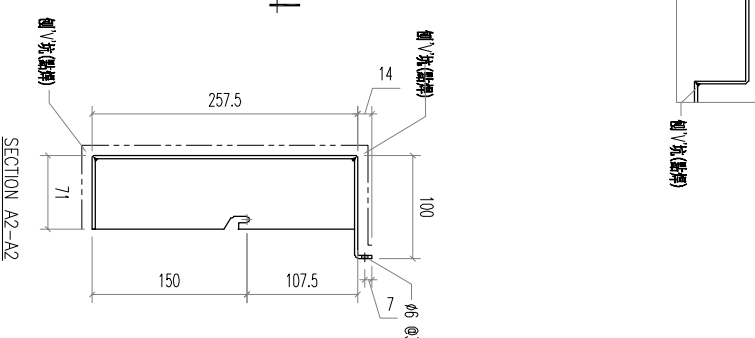
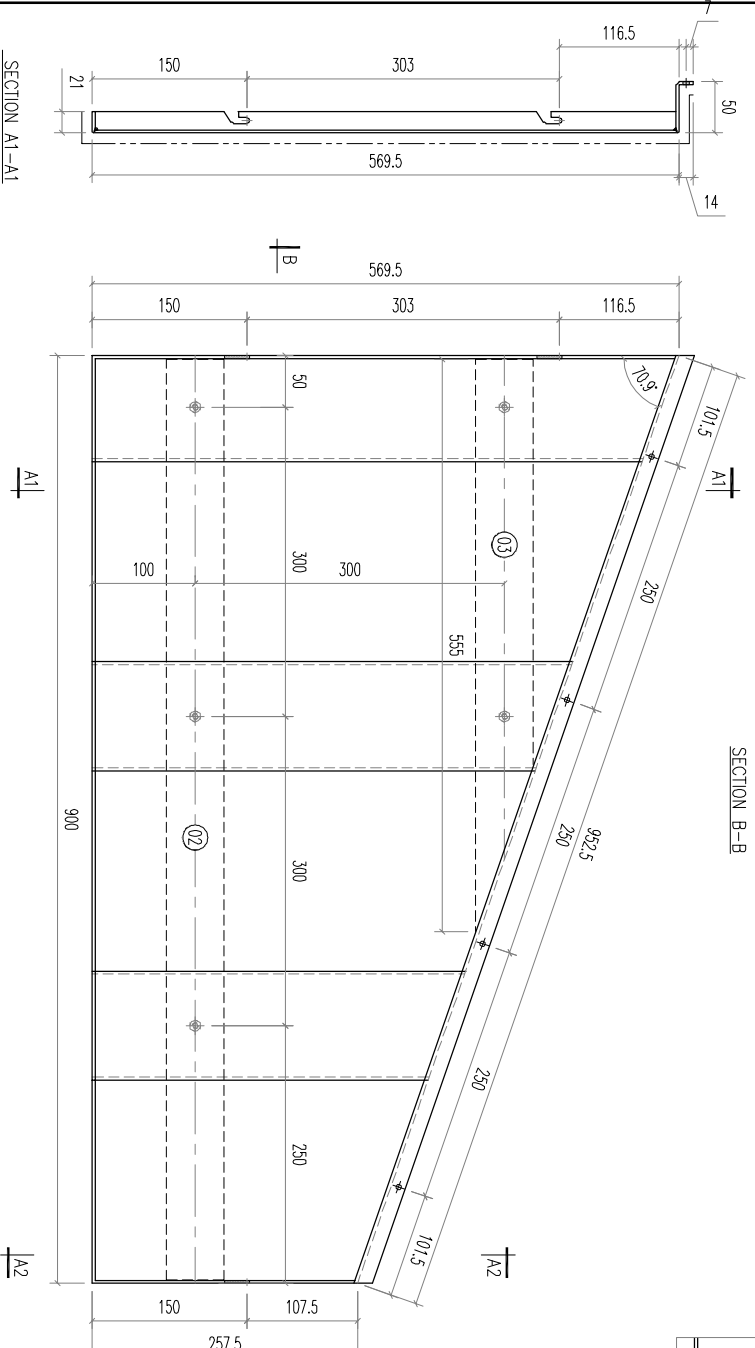
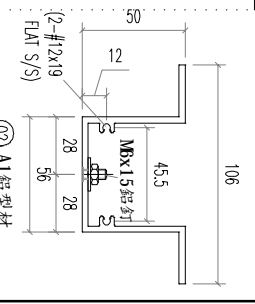
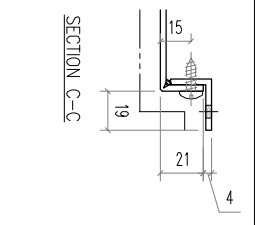
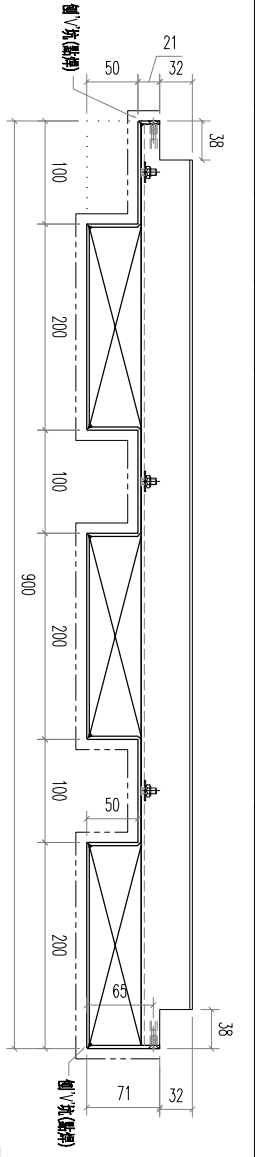

03	A1 鋁型材	555	開料	1	
02	A1 鋁型材	893	開料	1	
序號	材料規格	長度	配件描述	數量	备注

**美特鋁質有限公司**  
 MIDI ALUMINIUM FABRICATOR LTD.  
 Units 6-8, Sunroy Industrial Centre, 1/F  
 610 Cho Kwo Ling Road, Kowloon  
 Tel: 23489211-4 Fax: (852) 27727666

PROJECT	J853-PODIUM ALUM CEILING & FEATURE CLADDING T7 7/F	JOB NO.	J853
FACTORY	01	W/CENTRE	MOCK/SCBA/FAB
CUT ENDS	Angle	FINISH	EC-DG-0334232-201 (A1)
DATE	4/19/2023	DRAWN	YEUNG
POST PAINT	SCALE	PART	
PART ASSEM.	TRACK TYPE	SHT.	-/-
REV.		REV.	-

REV. DATE	AMENDMENT	REVISED BY	DRAWING TITLE	DRAWING NO.	SHT.	REV.
			鋁板天花加工圖 3mm THK. ALUM. PLATE	T7-CE02-12-06	-/-	-

REV.	CHECKED BAR BY	PART NUMBER	Dim. A	Dim. B	Dim. C	Dim. D	Dim. E	Dim. F	Dim. G	QTY	Inv. Code	ASSEMBLE ON PARTS	EXTR. DRAWING PART DRAWING
-		T7-CE02-13-01								1			

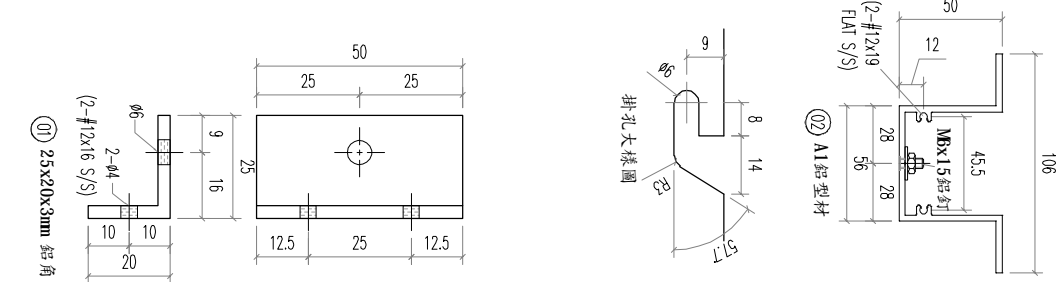
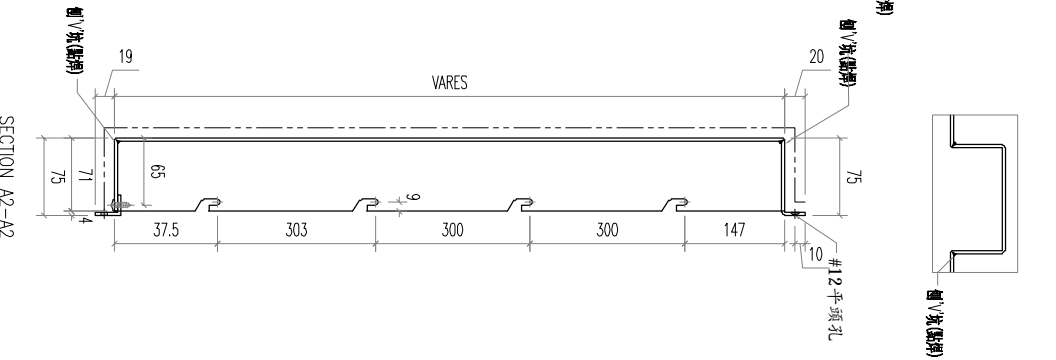
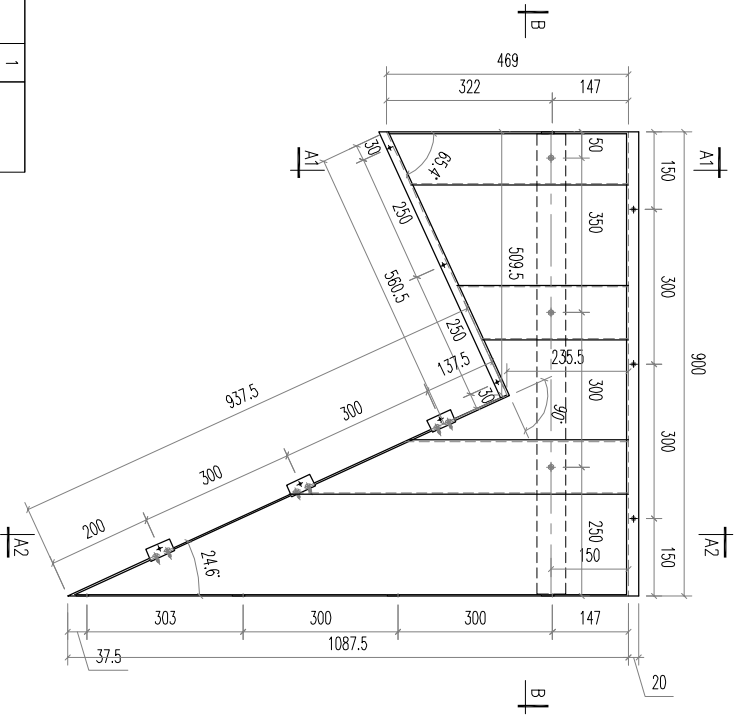
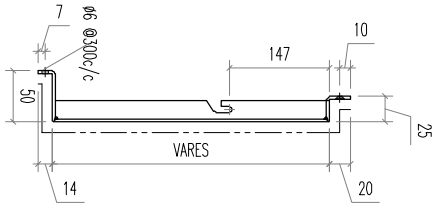
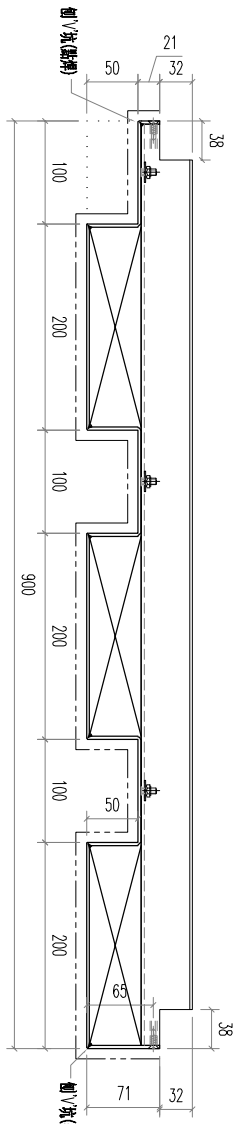

REV.	DATE	AMENDMENT	REVISED BY
02		A1 鋁型材	
01		2.5x20x3mm 鋁角	
		材料規格	長度
		開料	開料
		配件描述	數量
			备注

**美特鋁質有限公司**  
MIDI ALUMINIUM FABRICATOR LTD.  
Units 6-8, Sunray Industrial Centre, 1/F  
610 Cho Kwo Ling Road, Kowloon  
Tel: 23489211-4 Fax: (852) 27727666

PROJECT	JOB NO.	DRAWING TITLE	FACTORY	W/CENTRE	CUT ENDS	FINISH	DATE	DRAWN	SCALE	POST PAINT	PART	SHT.	REV.
J853-PODIUM ALUM CEILING & FEATURE CLADDING T7 7/F	J853	鋁板天花加工圖 3mm THK. ALUM PLATE	01	W/CENTRE MAX/SCA/FAB	Angle Squarness ±1°	EC-DG-0334232-201 (AL1)	4/19/2023	YEUNG	1:5	噴漆	噴漆	-/-	-
AMENDMENT													
REV.	DATE												

REV.	CHECKED DATE BY	PART NUMBER	Dim. A	Dim. B	Dim. C	Dim. D	Dim. E	Dim. F	Dim. G	QTY	Inv. Code	ASSEMBLE ON PARTS	EXTR. DRAWING PART DRAWING
-		T7-CE02-13-02								1			

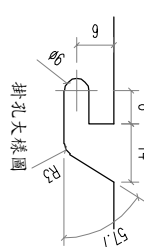
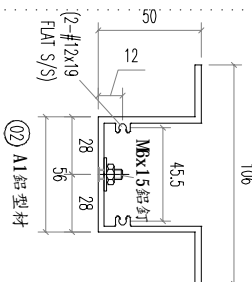
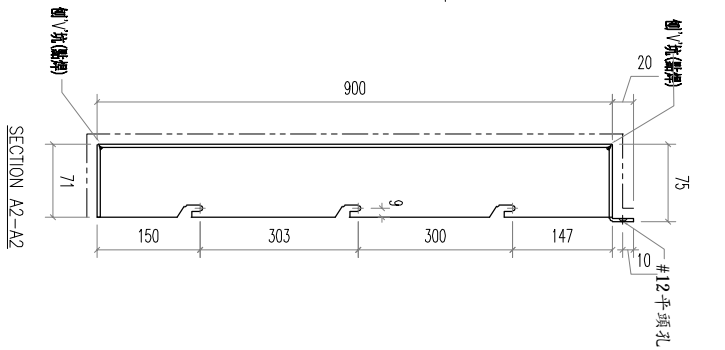
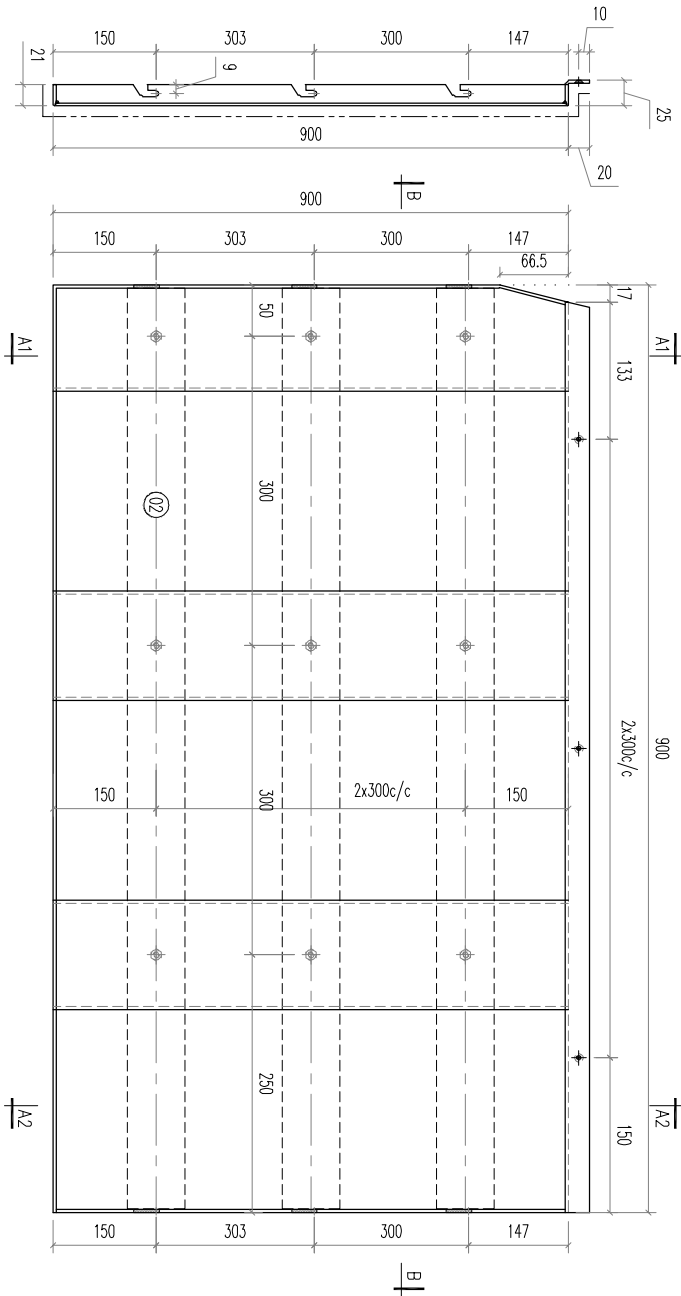
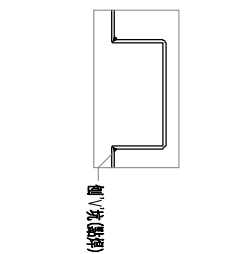
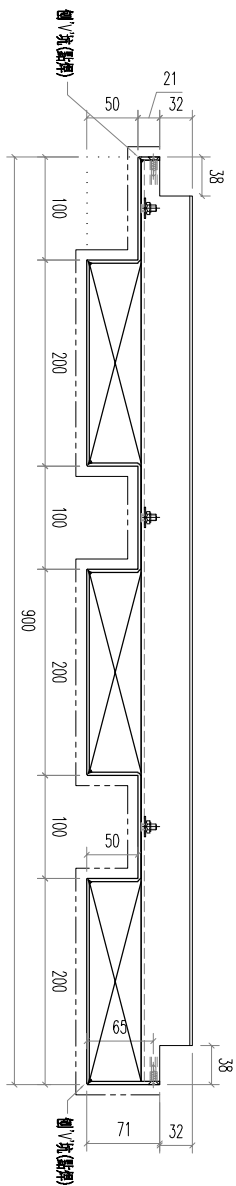

02	A1 鋁型材	893	開料	3	
REV.	DATE	AMENDMENT	REVISED BY		
<p>UNITED ALUMINIUM FABRICATOR LTD.          MIDU ALUMINIUM FABRICATOR LTD.          Units 6-8, Sunroy Industrial Centre, 1/F          610 Cho Kwo Ling Road, Kowloon          Tel:23489211-4 Fax:(852)2727666</p> <p>PROJECT J853-PODIUM ALUM CEILING          &amp; FEATURE CLADDING T7 7/F</p> <p>JOB NO. J853</p> <p>FACTORY 01 W/CENTRE WCKX/SKBA/FAB CUT ENDS Standard X X . X X . X = ±1 Angle ±1° DATE 4/19/2023</p> <p>FINISH EC-DG-0334232-201 (AL1) 噴漆</p> <p>DRAWING TITLE 鋁板天花加工圖 3mm THK. ALUM PLATE</p> <p>DRAWING NO. T7-CE02-13-02</p> <p>POST PAINT PRE PAINT SCALE 1:5</p> <p>PART TRACK ASSEM. SHT. -/-</p> <p>REV. -</p>					

REV.	CHECKED DATE BY	PART NUMBER	Dim. A	Dim. B	Dim. C	Dim. D	Dim. E	Dim. F	Dim. G	QTY	Inv. Code	ASSEMBLE ON PARTS	EXTR. DRAWING PART DRAWING
-		T7-CE02-13-03								1			

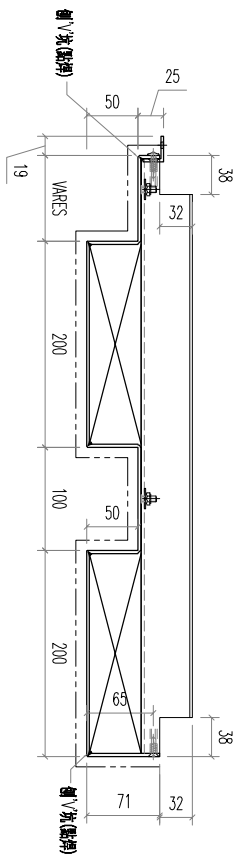

SECTION B-B

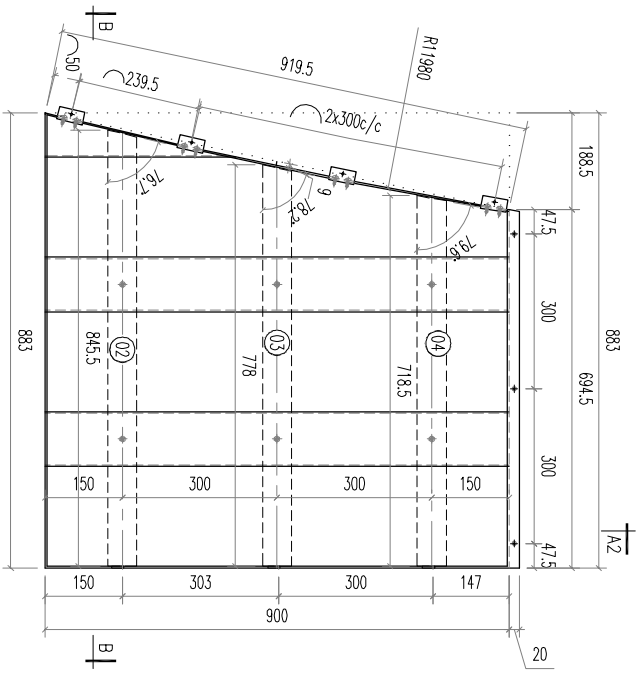

A1-A2

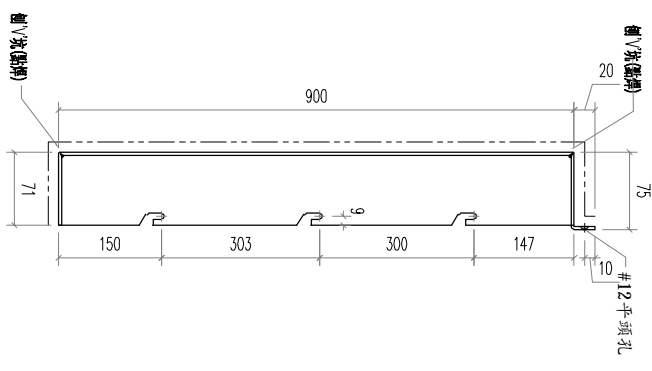

SECTION A2-A2

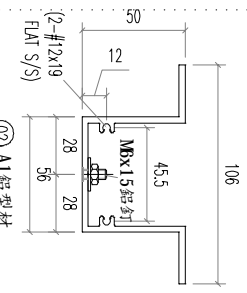

A1 鋁型材

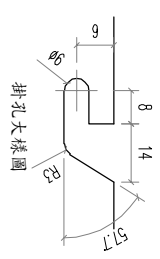

掛孔大樣圖

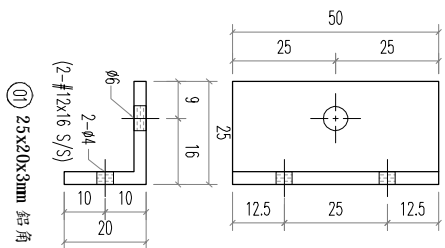

A1 25x20x3mm 鋁角

REV	DATE	AMENDMENT	REVISED BY			
04		A1 鋁型材	718.5	開料	1	
03		A1 鋁型材	778	開料	1	
02		A1 鋁型材	845.5	開料	1	
01		25x20x3mm 鋁角	50	開料	4	

材料規格  
長度  
配件描述  
數量  
备注

美特鋁質有限公司  
MIDI ALUMINIUM FABRICATOR LTD.

Units 6-8, Sunray Industrial Centre, 1/F  
610 Cho Kwo Ling Road, Kowloon  
Tel:23489211-4 Fax:(852)27727666

REV	DATE	AMENDMENT	REVISED BY

PROJECT J853-PODIUM ALUM CEILING  
& FEATURE CLADDING T7 7/F

JOB NO. J853  
FACTORY 01  
W/CENTRE MCKK/SKBA/FAB  
CUT ENDS  
FINISH EC-DG-0334232-201 (AL1)  
DATE 4/19/2023  
DRAWING TITLE 鋁板天花加工圖  
3mm THK. ALUM PLATE

DRAWING NO. T7-CE02-13-03  
SHT. -/-  
REV. -

REV.	CHECKED DATE BY	PART NUMBER	Dim. A	Dim. B	Dim. C	Dim. D	Dim. E	Dim. F	Dim. G	QTY	Inv. Code	ASSEMBLE ON PARTS	EXTR. DRAWING PART DRAWING
-		T7-CE02-13-04								1			

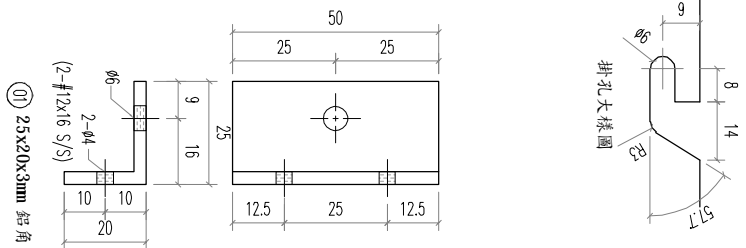
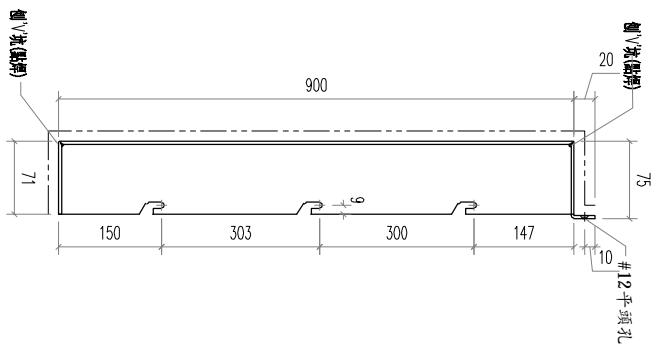
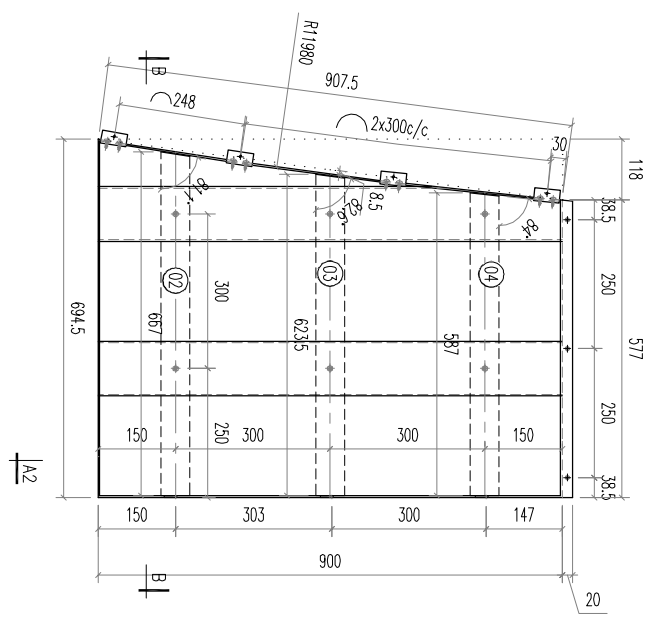
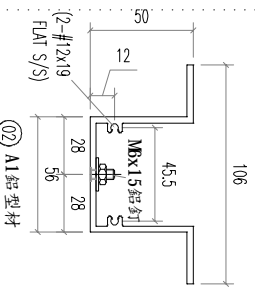
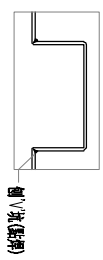
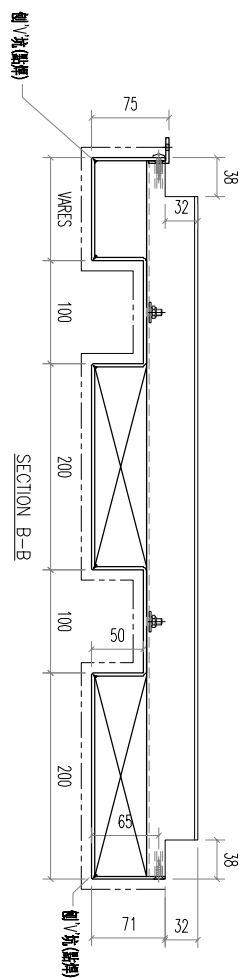

REV.	DATE	AMENDMENT	REVISED BY			
04		A1 鋁型材	587	開料	1	
03		A1 鋁型材	623.5	開料	1	
02		A1 鋁型材	667	開料	1	
01		25x20x3mm 鋁角	50	開料	4	
		材料規格	長度	配件描述	數量	备注

**美特鋁質有限公司**  
MIDI ALUMINIUM FABRICATOR LTD.  
Units 6-8, Sunray Industrial Centre, 1/F  
610 Cho Kwo Ling Road, Kowloon  
Tel: 23489211-4 Fax: (852) 2727666

PROJECT	J853-PODIUM ALUM CEILING & FEATURE CLADDING T7 7/F	JOB NO.	J853	DRAWING TITLE	鋁板天花加工圖 3mm THK. ALUM PLATE	DRAWING NO.	T7-CE02-13-04	SHT.	-/-	REV.	-
FACTORY	01	W/CENTRE	MAX/SCBA/FAB	CUT ENDS	FINISH	EC-DG-0334232-201 (AL1)	DATE	4/19/2023	POST PAINT	SCALE	1:5
Standard	X X .	Angle	±1°	Squareness	±1°	噴漆	DRAMIN	YEUNG	PART	TRACK TYPE	S....
Tolerances	X X . X = ±0.5										

REV.	CHECKED DATE	PART NUMBER	Dim. A	Dim. B	Dim. C	Dim. D	Dim. E	Dim. F	Dim. G	QTY	Inv. Code	ASSEMBLE ON PARTS	EXTR. DRAWING PART DRAWING
-		T7-CE02-13-05								1			

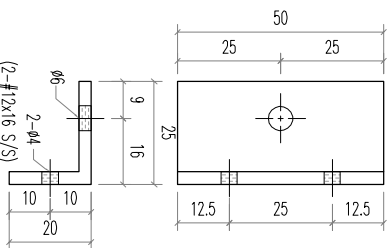
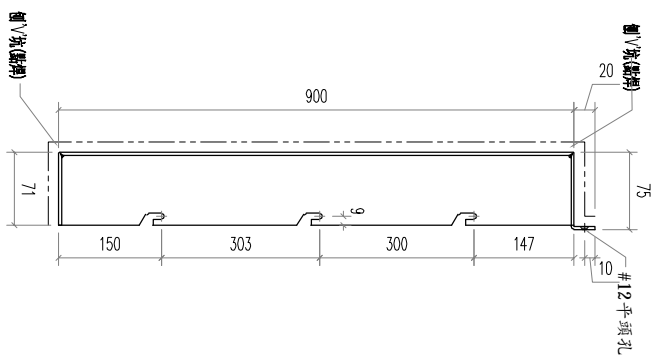
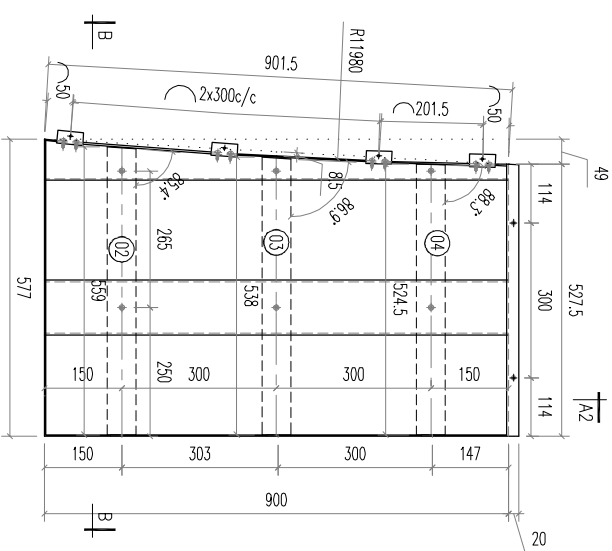
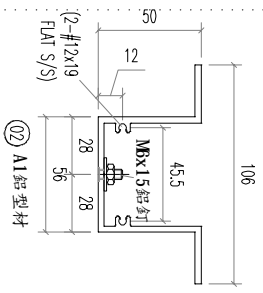
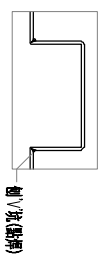
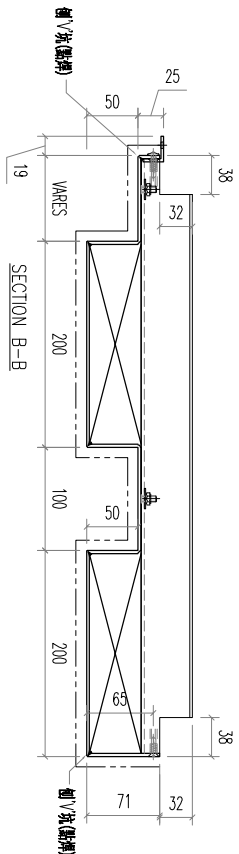

REV	DATE	AMENDMENT	REVISED BY		
04		A1 鋁型材	524.5	開料	1
03		A1 鋁型材	538	開料	1
02		A1 鋁型材	559	開料	1
01		2.5X20X3mm 鋁角	50	開料	4

材料規格

長度

配件描述

數量

备注

**美特鋁質有限公司**  
MIDI ALUMINIUM FABRICATOR LTD.

Units 6-8, Sunroy Industrial Centre, 1/F  
610 Cha Kwo Ling Road, Kowloon  
Tel:23489211-4 Fax:(852)27727666

PROJECT J853-PODIUM ALUM CEILING  
& FEATURE CLADDING T7 7/F

JOB NO. J853

FACTORY 01  
W/CENTRE MARK/SKID/FAB

CUT ENDS

FINISH EC-DG-0334232-201 (AL1)

DATE 4/19/2023

POST PAINT PRE PAINT SCALE 1:5

PART SUB ASSEM. TRACK TYPE S.....

Standard Tolerances X X . X = ±1  
X X . X = ±05 Angle Squareness ±1°

DRAWING TITLE 鋁板天花加工圖  
3mm THK. ALUM PLATE

DRAWING NO. T7-CE02-13-05

SHT. REV. -/-

REV. CHECKED BAR BY	PART NUMBER	Dim. A	Dim. B	Dim. C	Dim. D	Dim. E	Dim. F	Dim. G	QTY	Inv. Code	ASSEMBLE ON PARTS	EXTR. DRAWING PART DRAWING
-	T7-CE02-13-06								1			

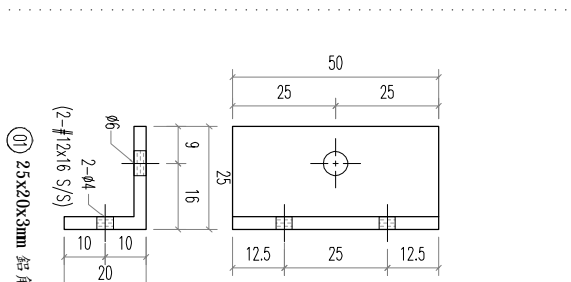
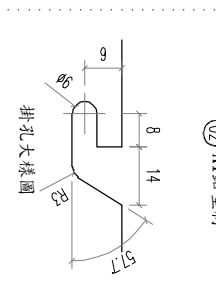
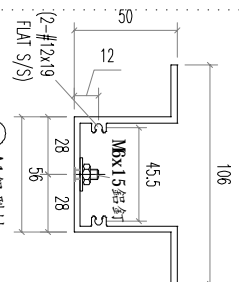
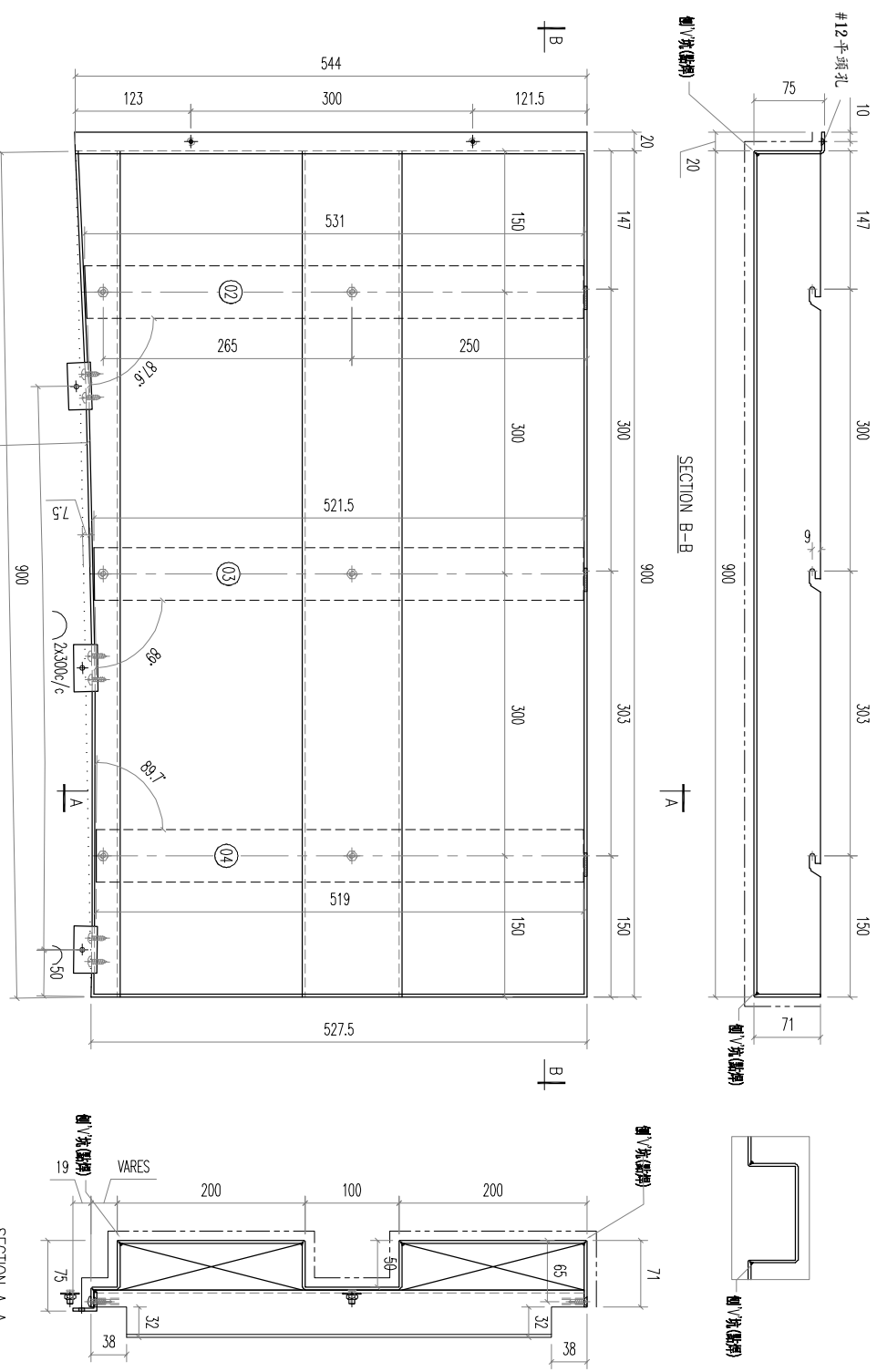

04	A1 鋁型材	519	開料	1	
03	A1 鋁型材	521.5	開料	1	
02	A1 鋁型材	531	開料	1	
01	25x20x3mm 鋁角	50	開料	3	

序號	材料規格	長度	配件描述	數量	备注

**美特鋁質有限公司**  
MIDI ALUMINIUM FABRICATOR LTD.  
Units 6-8, Sunroy Industrial Centre, 1/F  
610 Cho Kwo Ling Road, Kowloon  
Tel: 23489211-4 Fax: (852) 27727666

REV. DATE	AMENDMENT	REVISED BY	PROJECT	JOB NO.	DRAWING TITLE	DRAWING NO.	POST PAINT	PART	SHT.	REV.	
			J853-PODIUM ALUM CEILING & FEATURE CLADDING T7 7/F	J853	鋁板天花加工圖 3mm THK. ALUM PLATE	T7-CE02-13-06	噴漆 EC-DG-0334232-201 (AL)	PRE PAINT SCALE 1:5	TRACK TYPE S....	-/-	-

REV.	CHECKED DATE BY	PART NUMBER	Dim. A	Dim. B	Dim. C	Dim. D	Dim. E	Dim. F	Dim. G	QTY	Inv. Code	ASSEMBLE ON PARTS	EXTR. DRAWING PART DRAWING
-		T7-CE02-13-07								1			

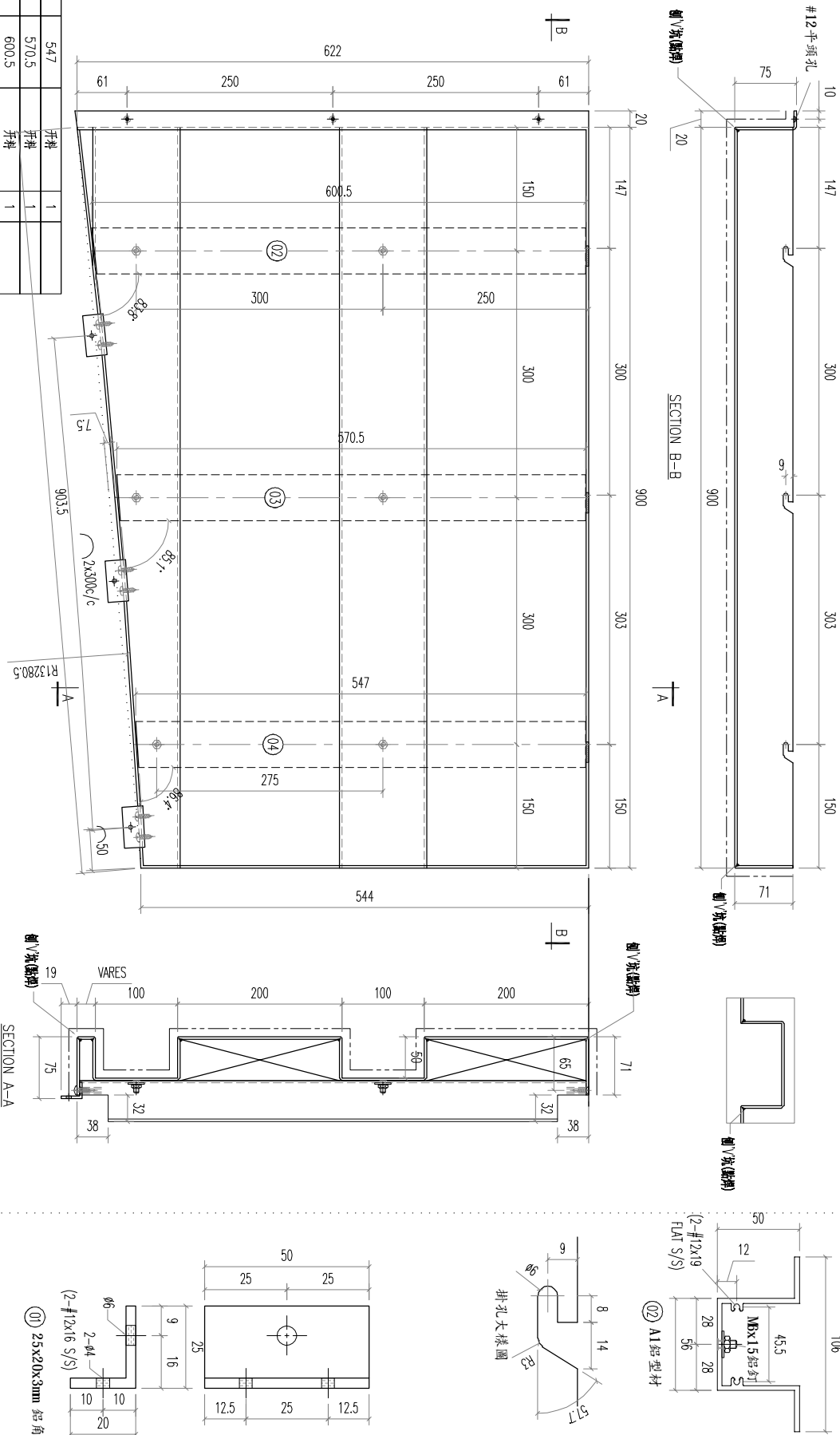

REV.	DATE	AMENDMENT	REVISED BY
04		A1 鋁型材	
03		A1 鋁型材	
02		A1 鋁型材	
01		2.5x20x3mm 鋁角	

序號	材料規格	長度	配件描述	數量	备注
04	A1 鋁型材	547	開料	1	
03	A1 鋁型材	570.5	開料	1	
02	A1 鋁型材	600.5	開料	1	
01	2.5x20x3mm 鋁角	50	開料	3	

FACTORY	W/CENTRE	CUT ENDS	FINISH	DATE	POST PAINT	PART
01	W/CENTRE	±1	EC-DG-0334232-201 (AL1)	4/19/2023	SCALE	TRACK TYPE
Standard	X X . X = ±1	Angle			1:5	S...
Tolerances	X X . X = ±0.5	Squareness ±1°				

**美特鋁質有限公司**  
MIDI ALUMINIUM FABRICATOR LTD.

Units 6-8, Sunroy Industrial Centre, 1/F  
610 Cho Kwo Ling Road, Kowloon  
Tel: 23489211-4 Fax: (852) 27727666

PROJECT J853-PODIUM ALUM CEILING & FEATURE CLADDING T7 7/F

JOB NO.	DRAWING TITLE	DRAWING NO.	SHT.	REV.
J853	鋁板天花加工圖 3mm THK. ALUM PLATE	T7-CE02-13-07	-/-	-

REV.	CHECKED DATE BY	PART NUMBER	Dim. A	Dim. B	Dim. C	Dim. D	Dim. E	Dim. F	Dim. G	QTY	Inv. Code	ASSEMBLE ON PARTS	EXTR. DRAWING PART DRAWING
-		T7-CE02-13-08								1			

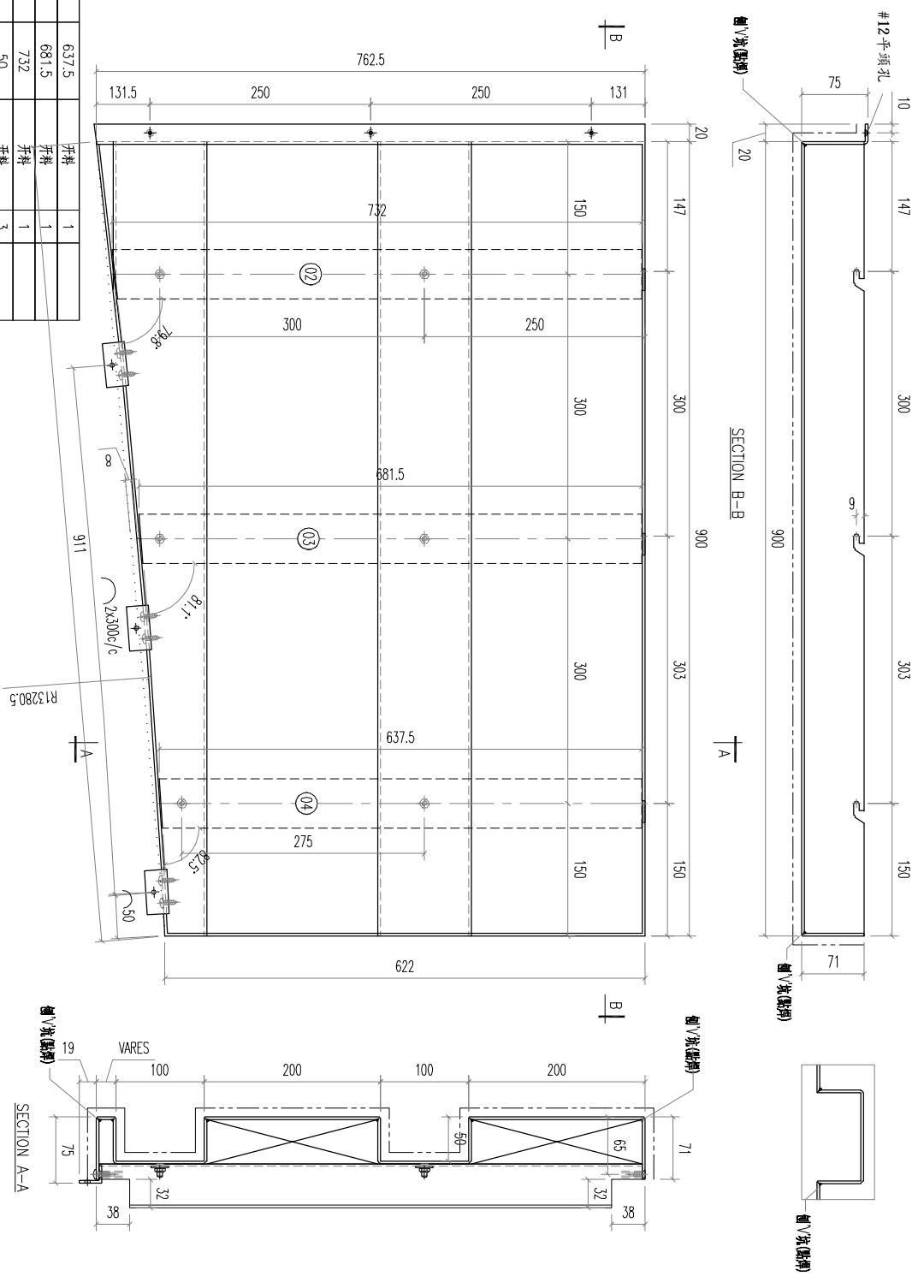

REV.	DATE	AMENDMENT	REVISED BY			
04		A1 鋁型材	637.5	1	1	
03		A1 鋁型材	681.5	1	1	
02		A1 鋁型材	732	1	1	
01		2.5x20x3mm 鋁角	50	3	3	

序號	材料規格	長度	配件描述	數量	备注
04	A1 鋁型材	637.5	1	1	
03	A1 鋁型材	681.5	1	1	
02	A1 鋁型材	732	1	1	
01	2.5x20x3mm 鋁角	50	3	3	

**美特鋁質有限公司**  
MIDI ALUMINIUM FABRICATOR LTD.  
Units 6-8, Sunroy Industrial Centre, 1/F  
610 Cho Kwo Ling Road, Kowloon  
Tel: 23489211-4 Fax: (852) 27727666

PROJECT	J853-PODIUM ALUM CEILING & FEATURE CLADDING T7 7/F	JOB NO.	J853	DRAWING TITLE	鋁板天花加工圖 3mm THK. ALUM PLATE	DRAWING NO.	T7-CE02-13-08	SHT.	-/-	REV.	-
FACTORY	01	W/CENTRE	MARK/SKID/FAB	CUT ENDS	±1°	FINISH	EC-DG-0334232-201 (AL1)	POST PAINT		PART	
Standard	X X .	Angle	±1°	DATE	4/19/2023	DRAWN	YEUNG	PRE PAINT		SUB ASSEM.	
Tolerances	X X . X = ±0.5	Squareness	±1°	SCALE	1:5	TRACK TYPE	S....				

REV.	CHECKED DATE BY	PART NUMBER	Dim. A	Dim. B	Dim. C	Dim. D	Dim. E	Dim. F	Dim. G	QTY	Inv. Code	ASSEMBLE ON PARTS	EXTR. DRAWING PART DRAWING
1		T7-CE02-13-09								1			

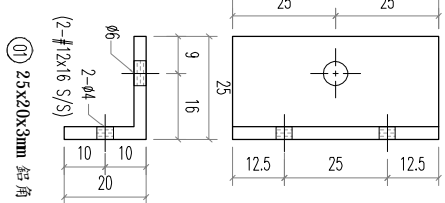
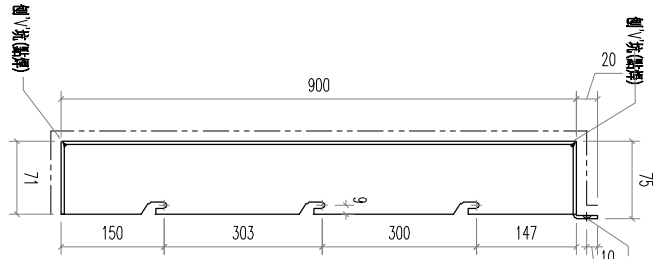
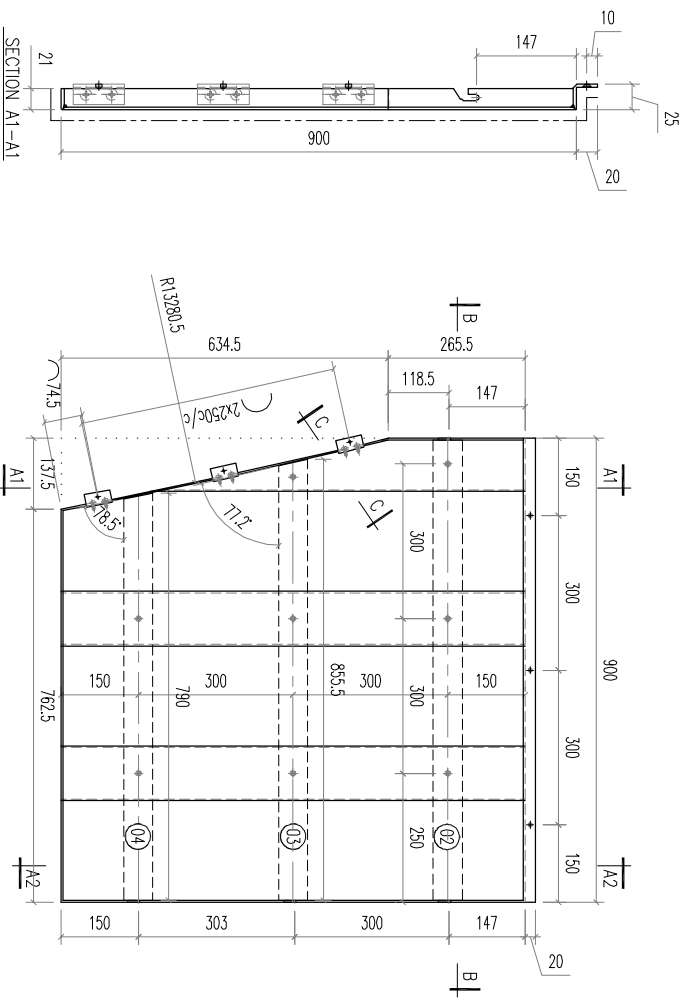
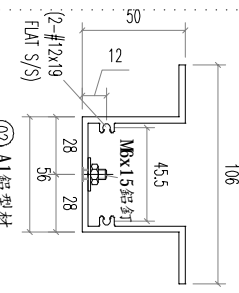
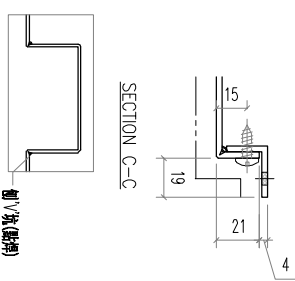
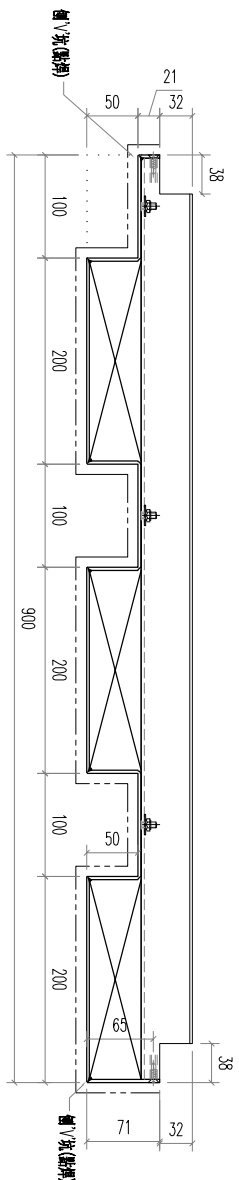

REV.	DATE	AMENDMENT	REVISED BY
04		A1 鋁型材	
03		A1 鋁型材	
02		A1 鋁型材	
01		2.5X20X3mm 鋁角	

序號	材料規格	長度	配件描述	數量	备注
01	2.5X20X3mm 鋁角	50	開槽	2	

FACTORY	W/CENTRE MARK/SCALE/FAB	CUT ENDS	FINISH	POST PAINT	PART
01	X X . X X . X = ±1 X X . X = ±05	Angle Squariness ±1°	EC-DG-0334232-201 (AL1) DATE 4/19/2023	噴漆 PRE PAINT	噴漆 SUB ASSEM.

**美特鋁質有限公司**  
MIDI ALUMINIUM FABRICATOR LTD.  
Units 6-8, Sunroy Industrial Centre, 1/F  
610 Cha Kwo Ling Road, Kowloon  
Tel:23489211-4 Fax:(852)27727666

PROJECT	J853-PODIUM ALUM CEILING & FEATURE CLADDING T7 7/F	JOB NO.	J853	DRAWING TITLE	鋁板天花加工圖 3mm THK. ALUM PLATE	DRAWING NO.	T7-CE02-13-09	SHT.	-/-	REV.	-
---------	----------------------------------------------------	---------	------	---------------	--------------------------------	-------------	---------------	------	-----	------	---

REV.	CHECKED BY	PART NUMBER	Dim. A	Dim. B	Dim. C	Dim. D	Dim. E	Dim. F	Dim. G	QTY	Inv. Code	ASSEMBLE ON PARTS	EXTR. DRAWING PART DRAWING
-		T7-CE02-13-10								1			

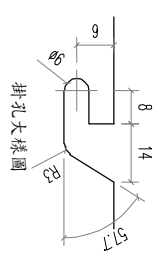
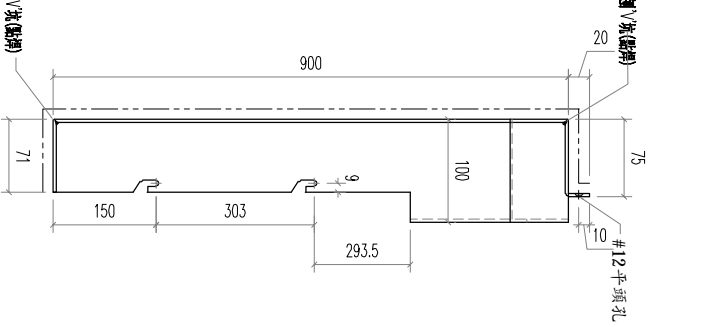
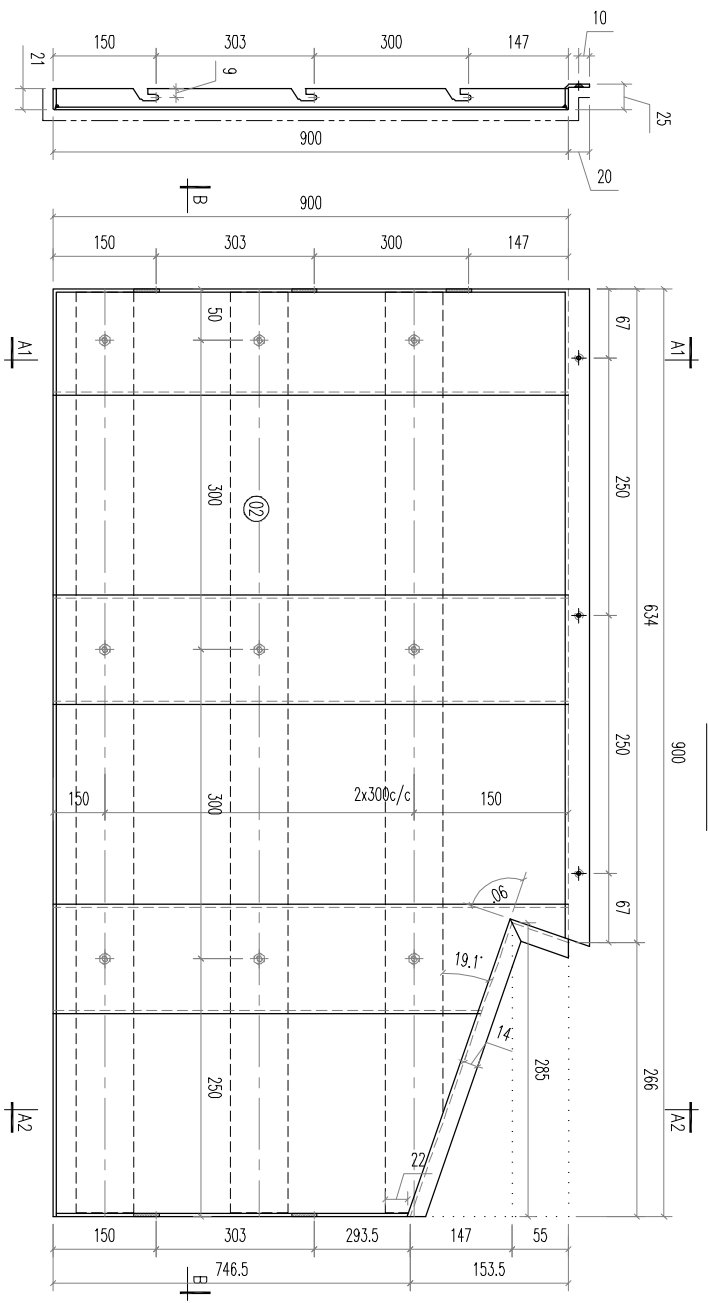
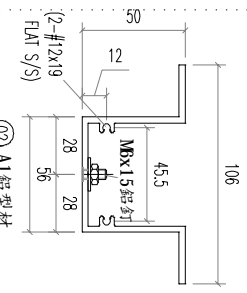
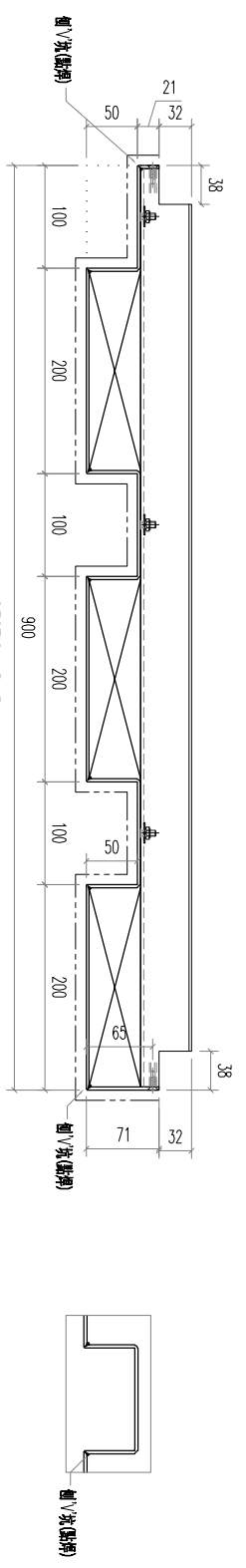

02	A1 鋁型材	893	開料	3	
REV	DATE	AMENDMENT	REVISED BY	備註	
<p>UNITED MIDD ALUMINIUM FABRICATOR LTD.</p> <p>美特鋁質有限公司</p> <p>Units 6-8, Sunroy Industrial Centre, 1/F 610 Cha Kwo Ling Road, Kowloon Tel: 23489211-4 Fax: (852) 2727666</p> <p>PROJECT J853-PODIUM ALUM CEILING &amp; FEATURE CLADDING T7 7/F</p> <p>JOB NO. J853</p> <p>FACTORY 01 W/CENTRE MBX4/SKBA/FAB CUT ENDS DATE 4/19/2023</p> <p>Standard X X . = ±1 Angle Squariness ±1'</p> <p>Tolerances X X . X = ±05</p> <p>DRAWING TITLE 鋁板天花加工圖 3mm THK. ALUM PLATE</p> <p>DRAWING NO. T7-CE02-13-10</p> <p>噴漆 PRE PAINT SCALE 1:5</p> <p>DRAMN YEUNG</p> <p>POST PAINT PART TRACK TYPE S.....</p>					

REV.	CHECKED DATE BY	PART NUMBER	Dim. A	Dim. B	Dim. C	Dim. D	Dim. E	Dim. F	Dim. G	QTY	Inv. Code	ASSEMBLE ON PARTS	EXTR. DRAWING PART DRAWING
-		T7-CE02-13-11								1			

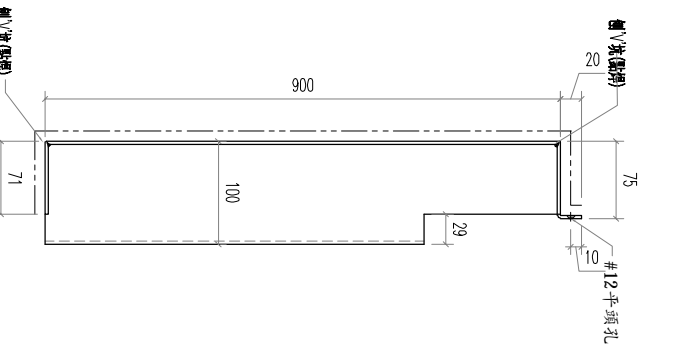
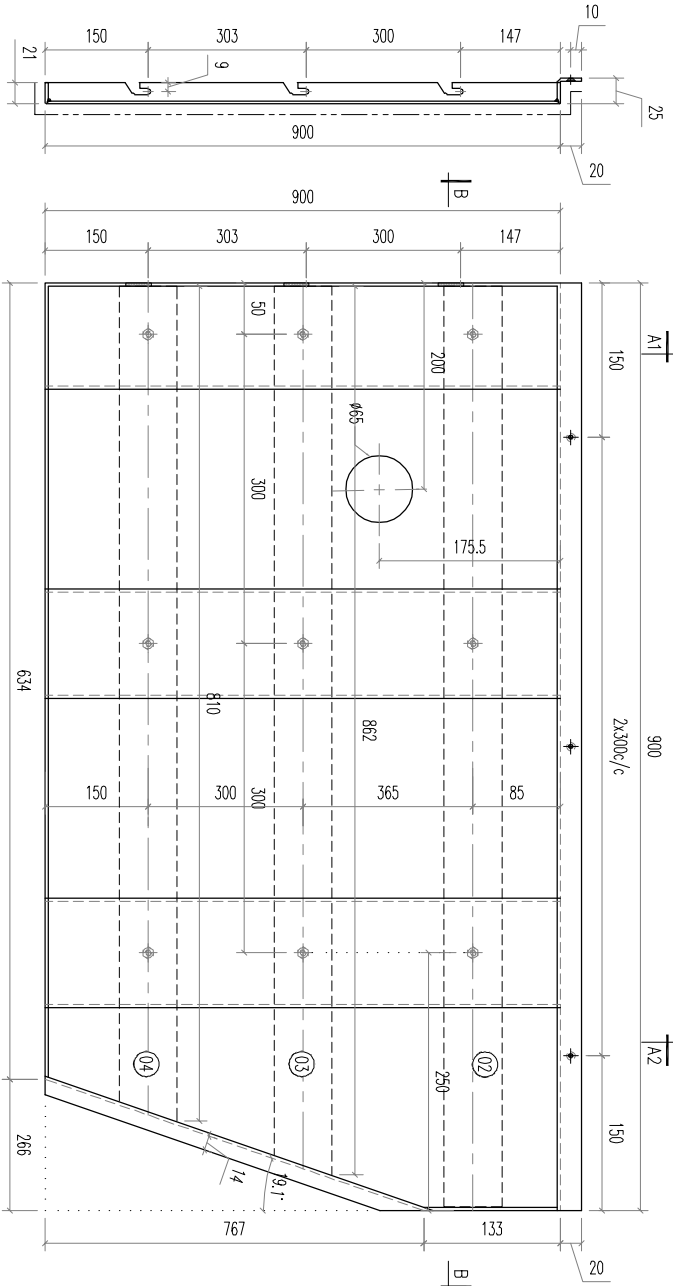
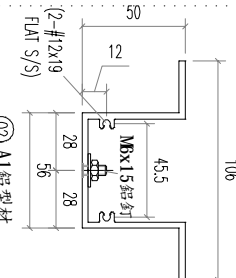
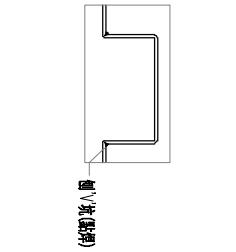
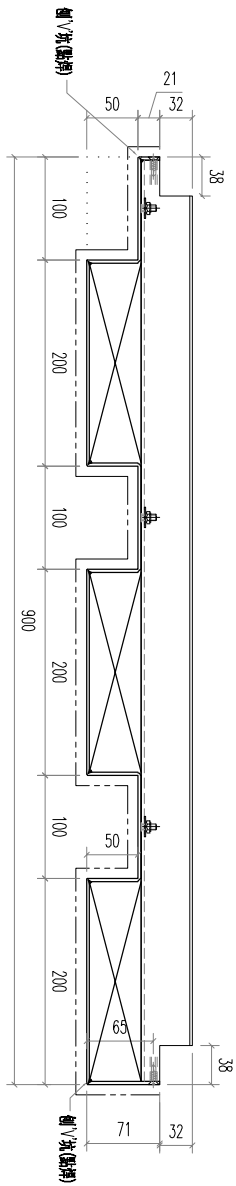

REV.	DATE	AMENDMENT	REVISED BY
04		A1 鋁型材	
03		A1 鋁型材	
02		A1 鋁型材	

序號	材料規格	長度	配件描述	數量	备注
04	A1 鋁型材	810	開梯	1	
03	A1 鋁型材	862	開梯	1	
02	A1 鋁型材	893	開梯	1	

FACTORY	W/CENTRE	CUT ENDS	FINISH	POST PAINT	PART
01	MAX/SCBA/FAB	Angle	EC-DG-0334232-201 (AL1)	SCALE	SUB ASSEM.
Standard	X X . = ±1	Angle	DATE	SCALE	TRACK TYPE
Tolerances	X X . X = ±05	Squareness ±1'	4/19/2023	1:5	S.....

**美特鋁質有限公司**  
MIDI ALUMINIUM FABRICATOR LTD.  
Units 6-8, Sunroy Industrial Centre, 1/F  
610 Cha Kwo Ling Road, Kowloon  
Tel:23489211-4 Fax:(852)27727666

PROJECT	J853-PODIUM ALUM CEILING	JOB NO.	J853	DRAWING TITLE	鋁板天花加工圖	DRAWING NO.	T7-CE02-13-11	SHT.	-/-	REV.	-
AMENDMENT	8 FEATURE CLADDING T7 7/F				3mm THK. ALUM PLATE						

REV.	CHECKED DATE BY	PART NUMBER	Dim. A	Dim. B	Dim. C	Dim. D	Dim. E	Dim. F	Dim. G	QTY	Inv. Code	ASSEMBLE ON PARTS	EXTR. DRAWING PART DRAWING
-		T7-CE02-13-12								1			

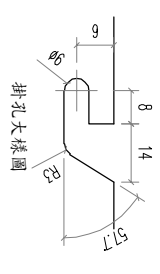
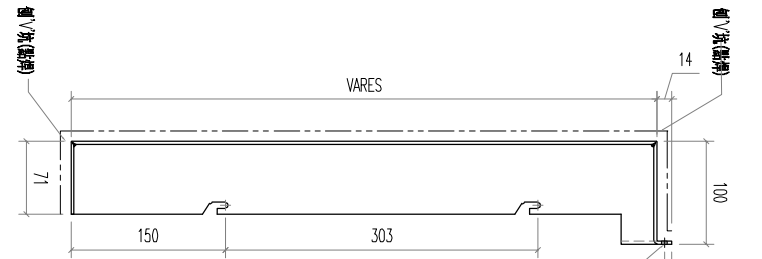
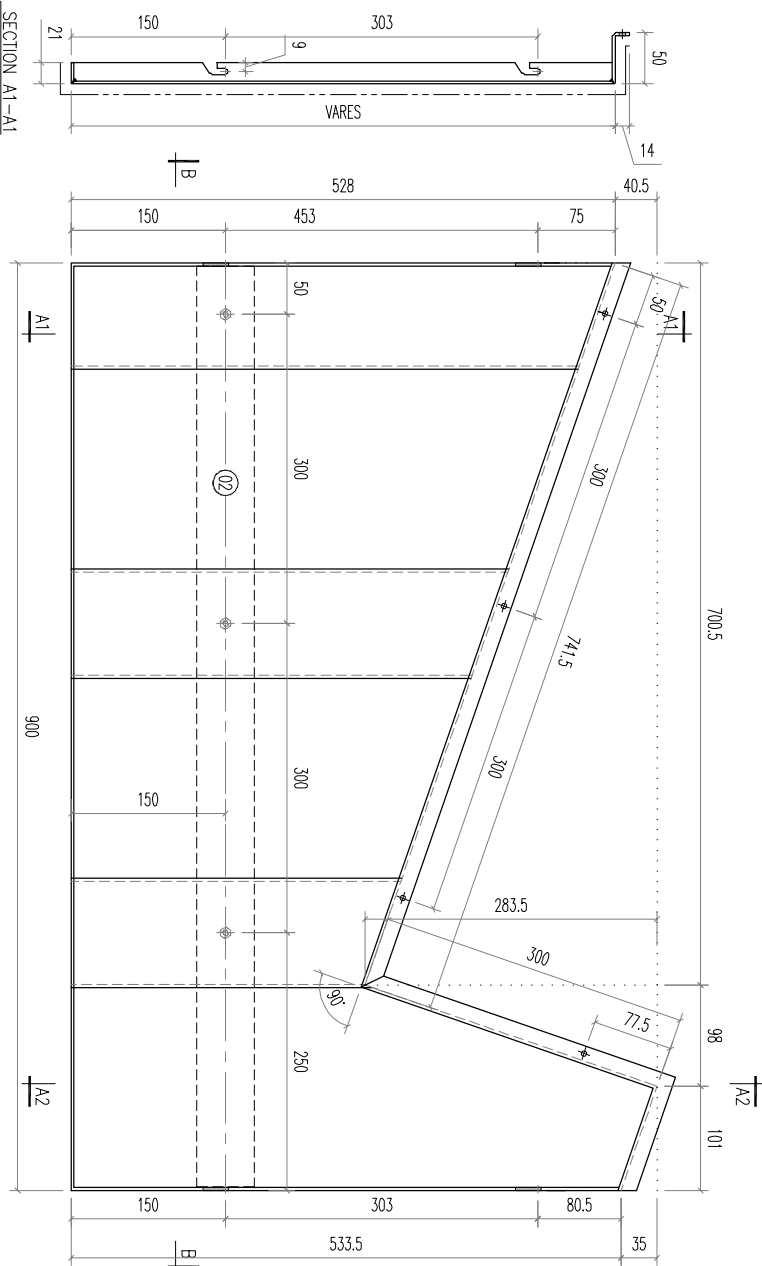
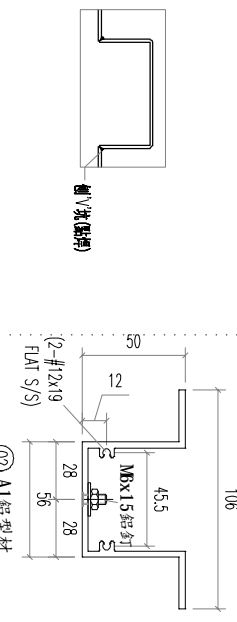
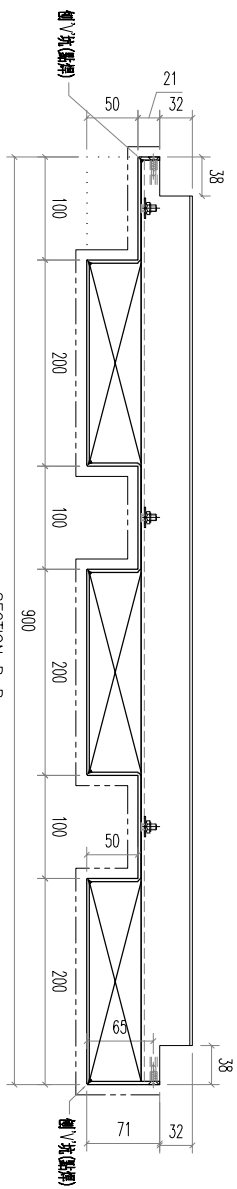

02	A1 鋁型材	893	開料	1	
REV.	DATE	AMENDMENT	REVISED BY	備註	
<p>材料規格</p> <p>長度</p> <p>配件描述</p> <p>數量</p>					
<p>UNITED ALUMINIUM FABRICATOR LTD.</p> <p>美特鋁質有限公司</p> <p>Units 6-8, Sunroy Industrial Centre, 1/F</p> <p>610 Cho Kwo Ling Road, Kowloon</p> <p>Tel:23489211-4 Fax:(852)2727666</p>					
<p>PROJECT J853-PODIUM ALUM CEILING &amp; FEATURE CLADDING T7 7/F</p> <p>JOB NO. J853</p>					
FACTORY 01		W/CENTRE MB04/S03A/FAB		CUT ENDS	
Standard		X X . = ±1		Angle	
Tolerances		X X X . X = ±05		Squarness ±1°	
DATE 4/19/2023		FINISH EC-DG-0334232-201 (AL1)		噴漆	
DRAWING TITLE 鋁板天花加工圖		DRAWN YEUNG		SCALE 1:5	
DRAWING NO. T7-CE02-13-12		POST PAINT		PART	
		SUB ASSEM.		SHT. -/-	
		TRACK TYPE		REV. -	
		S.....			

REV.	CHECKED DATE BY	PART NUMBER	Dim. A	Dim. B	Dim. C	Dim. D	Dim. E	Dim. F	Dim. G	QTY	Inv. Code	ASSEMBLE ON PARTS	EXTR. DRAWING PART DRAWING
-		T7-CE02-14-01								1			

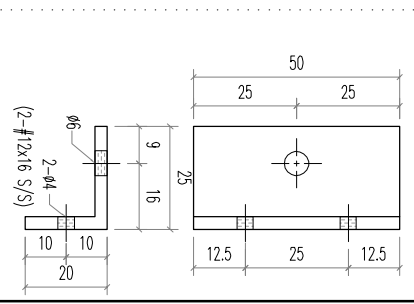
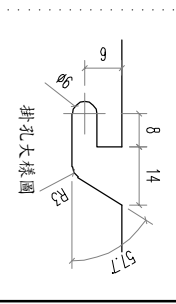
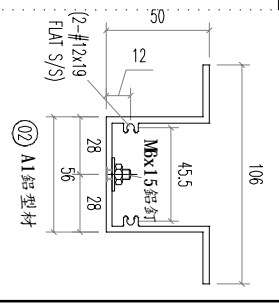
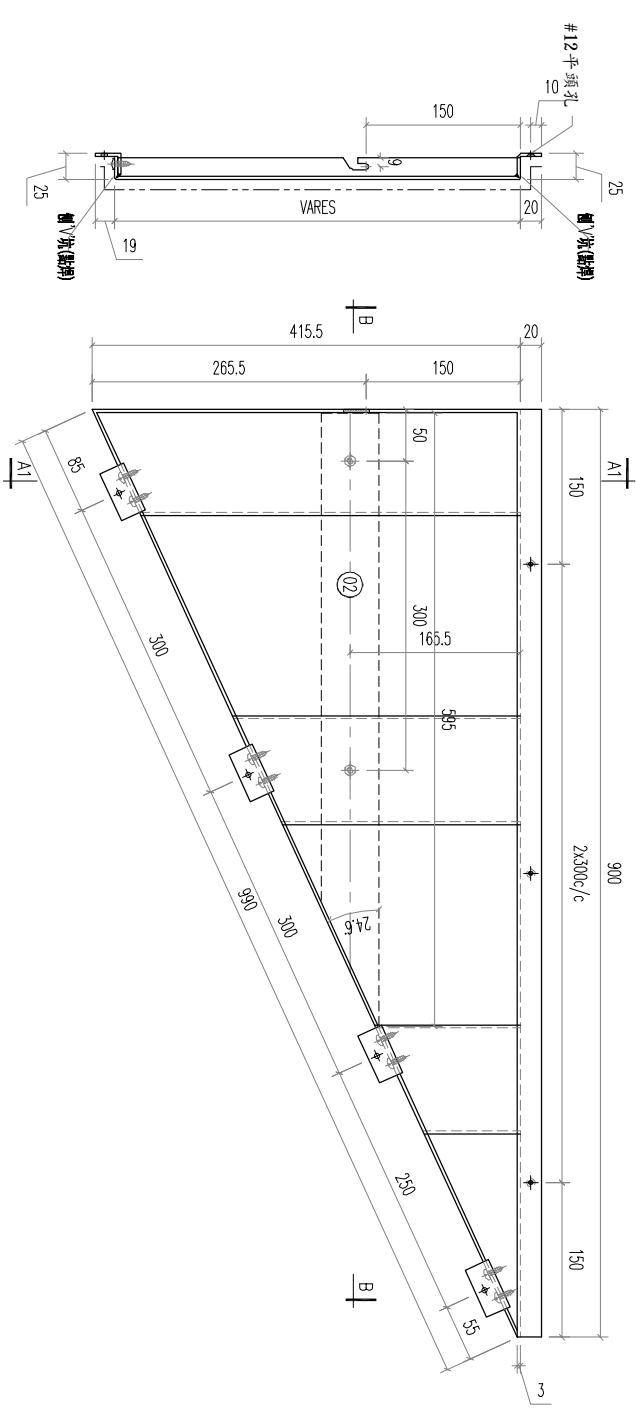
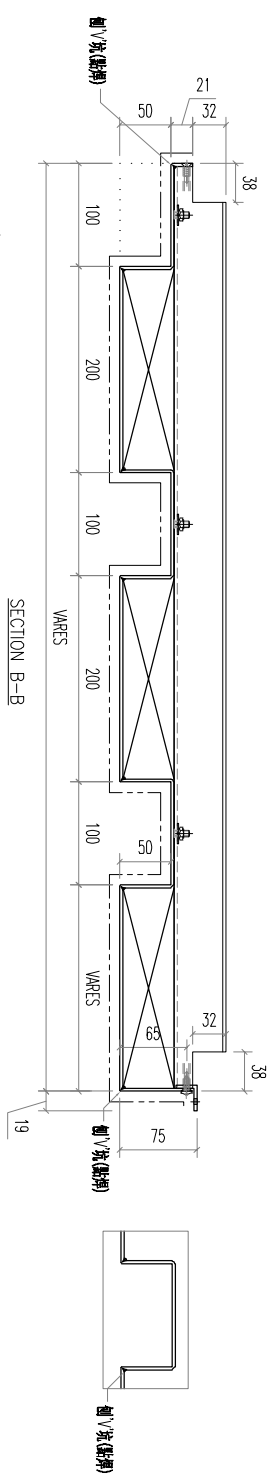

REV.	DATE	AMENDMENT	REVISED BY
02		A1 鋁型材	
01		2.5x20x3mm 鋁角	
		材料規格	長度
		零件描述	數量
			备注

美特鋁質有限公司  
MIDI ALUMINIUM FABRICATOR LTD.  
Units 6-8, Sunroy Industrial Centre, 1/F  
610 Cho Kwo Ling Road, Kowloon  
Tel:23489211-4 Fax:(852)27727666

FACTORY	W/CENTRE	CUT ENDS	FINISH
01	MAX/SKBA/FAB		EC-D6-0334232-201 (A1)
Standard	X X . = ±1	Angle	DATE
Tolerances	X X . X = ±05	Squareness ±1'	4/19/2023

DRAWING TITLE	DRAWING NO.	POST PAINT	PART
鋁板天花加工圖 3mm THK. ALUM PLATE	T7-CE02-14-01	PRE PAINT	SUB ASSEM.
		SCALE	TRACK TYPE
		1:5	S....
			SHT.
			REV.

REV.	DATE	AMENDMENT	REVISED BY	PROJECT	JOB NO.	DRAWING TITLE	DRAWING NO.	SHT.	REV.
				J853-PODIUM ALUM CEILING & FEATURE CLADDING T7 7/F	J853	鋁板天花加工圖 3mm THK. ALUM PLATE	T7-CE02-14-01	-/-	-

REV.	CHECKED DATE BY	PART NUMBER	Dim. A	Dim. B	Dim. C	Dim. D	Dim. E	Dim. F	Dim. G	QTY	Inv. Code	ASSEMBLE ON PARTS	EXTR. DRAWING PART DRAWING
-		T7-CE02-14-02								1			

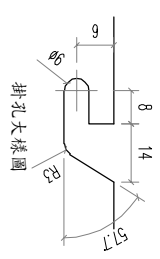
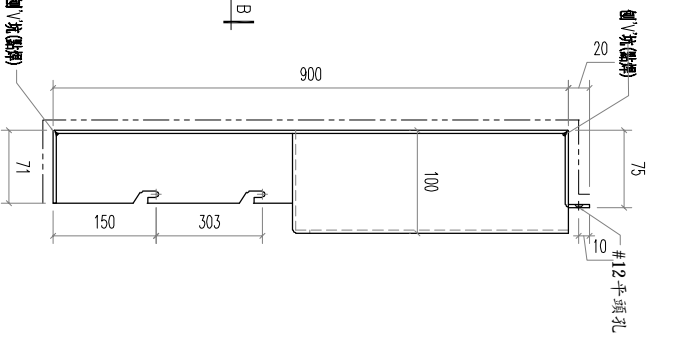
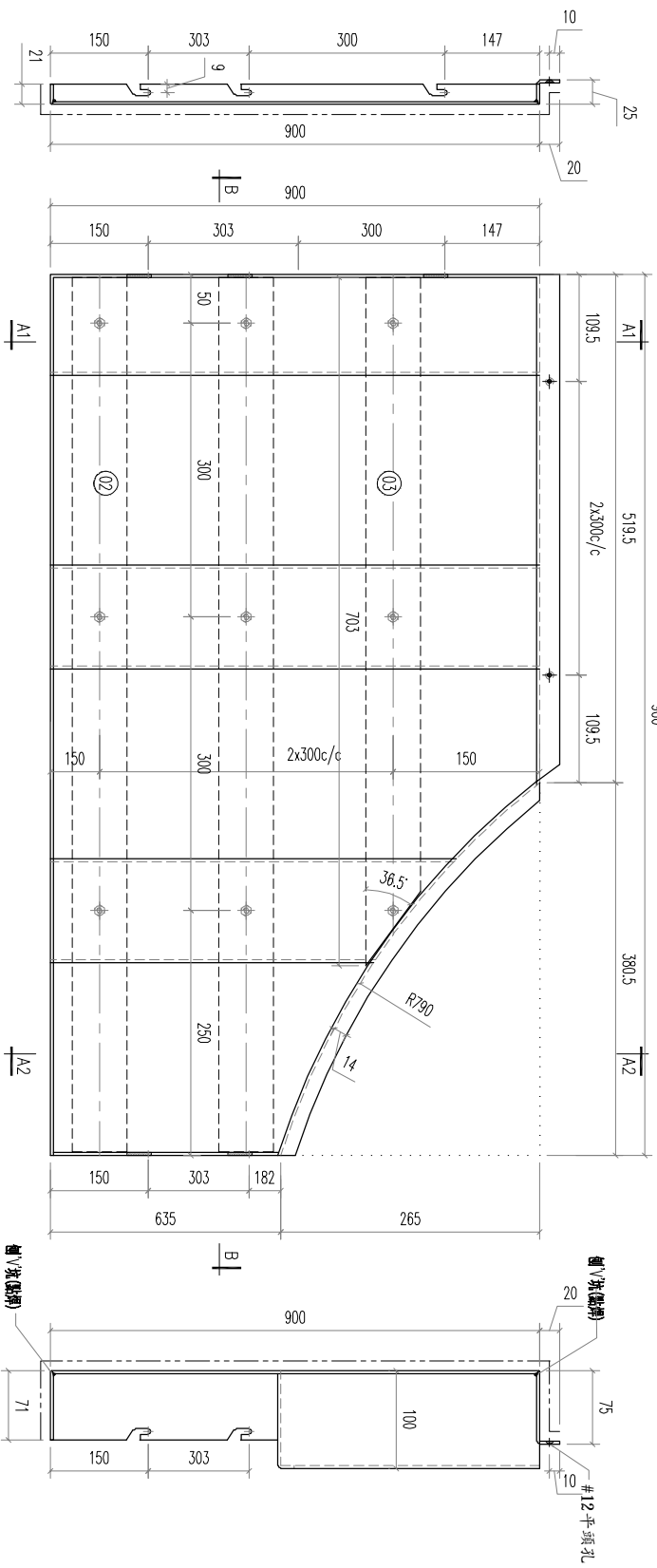
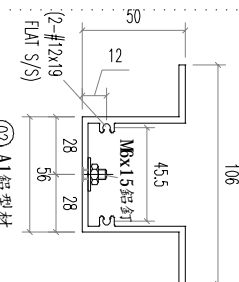
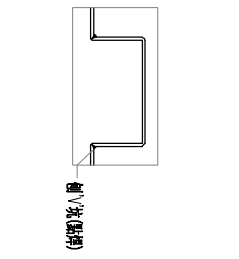
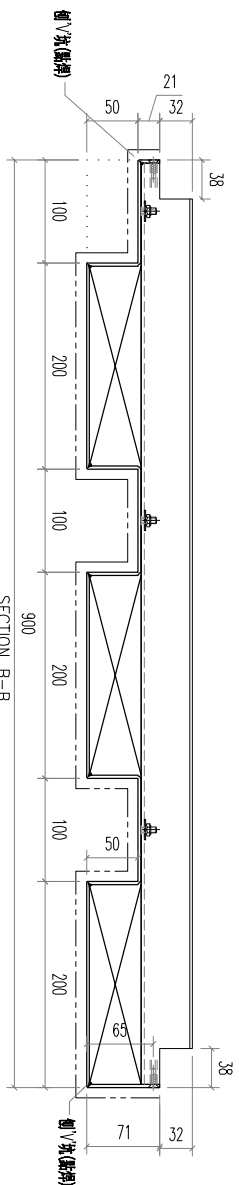

SECTION A1-A1

SECTION A2-A2

REV	DATE	AMENDMENT	REVISED BY
03		A1 鋁型材	
02		A1 鋁型材	
		材料規格	
		長度	
		配件描述	
		數量	
		备注	

**美特鋁質有限公司**  
MIDI ALUMINIUM FABRICATOR LTD.

Units 6-8, Sunroy Industrial Centre, 1/F  
610 Cho Kwo Ling Road, Kowloon  
Tel: 23489211-4 Fax: (852) 27727666

PROJECT J853-PODIUM ALUM CEILING  
& FEATURE CLADDING T7 7/F

J853

FACTORY	W/CENTRE	CUT ENDS	FINISH	DATE
01	MAX/SKID/FAB	Angle	EC-DG-0334232-201 (AL1)	4/19/2023
Standard	X X . = ±1	Angle		
Tolerances	X X . X = ±05	Squareness ±1'		

DRAWING TITLE  
鋁板天花加工圖  
3mm THK. ALUM PLATE

DRAWING NO.	SCALE	POST PAINT	PART	SHT.	REV.
T7-CE02-14-02	1:5	<input checked="" type="checkbox"/>	TRUCK ASSEM.	-/-	-

REV.	CHECKED DATE BY	PART NUMBER	Dim. A	Dim. B	Dim. C	Dim. D	Dim. E	Dim. F	Dim. G	QTY	Inv. Code	ASSEMBLY ON PARTS	EXTR. DRAWING PART DRAWING
-		T7-CE02-14-03								1			

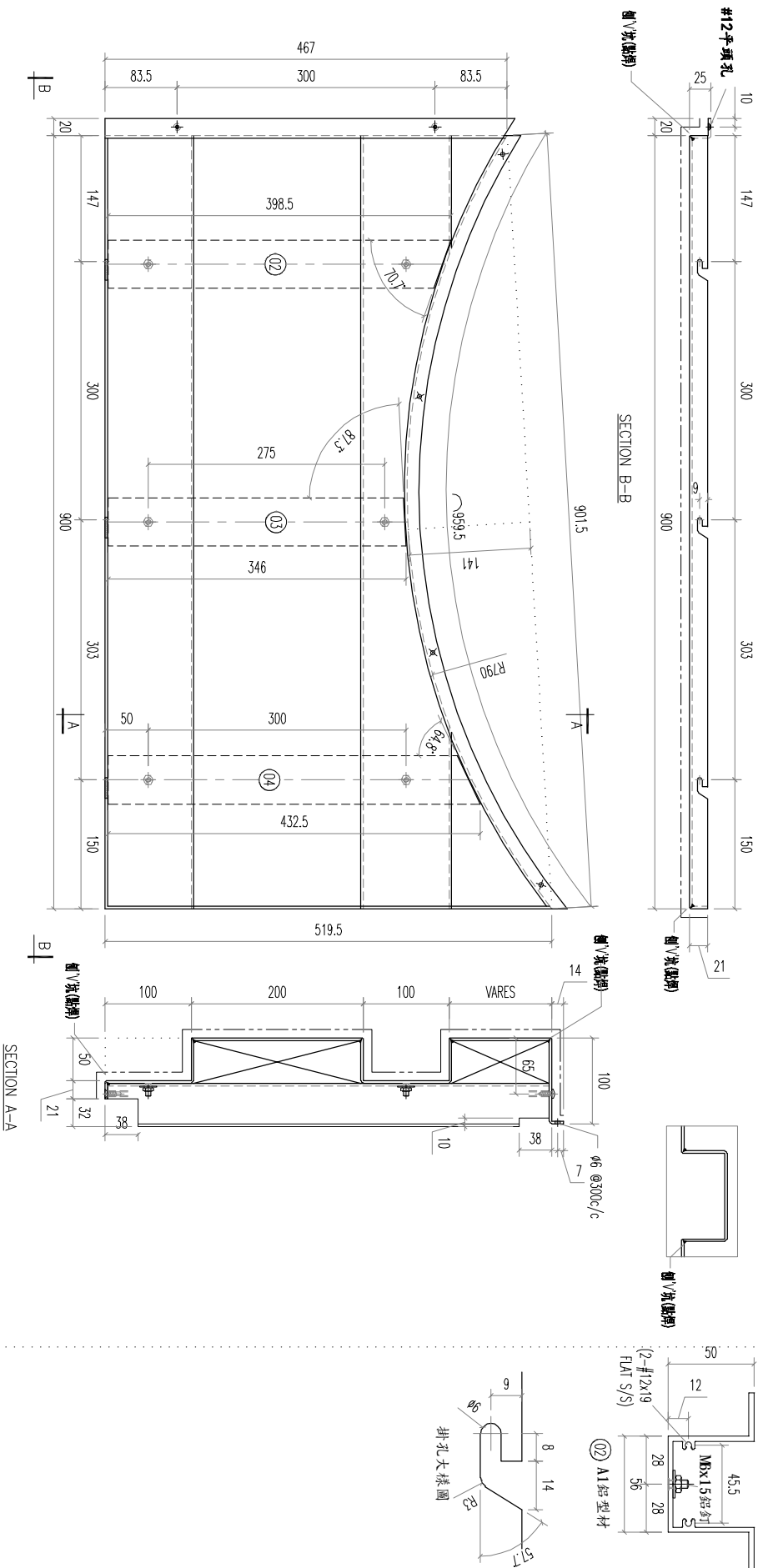

REV.	DATE	AMENDMENT	REVISED BY
04		A1 铝型材	432.5
03		A1 铝型材	346
02		A1 铝型材	398.5

序号	材料规格	长度	配件描述	数量	备注

**美特铝质有限公司**  
MIDI ALUMINIUM FABRICATOR LTD.

Units 6-8, Sunroy Industrial Centre, 1/F  
610 Cha Kwo Ling Road, Kowloon  
Tel: 233489211-4 Fax: (852) 27727666

PROJECT J853-PODIUM ALUM CEILING  
& FEATURE CLADDING T7 7/F

J853

FACTORY	W/CENTRE MARK/SCBA/FAB	CUT ENDS	FINISH
01		Angle	EC-DG-0334232-Z01 (AL)
Standard	X X . = ±1	Angle	DATE 4/19/2023
Tolerances	X X . X = ±05	Squareness ±1°	

DRAWING TITLE  
铝板天花加工图  
3mm THK ALUM PLATE

DRAWING NO.	SCALE	POST PAINT	PART
T7-CE02-14-03	1:5	PRE PAINT	SUB ASSEM.
		SCALE	TRACK TYPE
			S....



REV.	CHECKED DATE	PART NUMBER	Dim. A	Dim. B	Dim. C	Dim. D	Dim. E	Dim. F	Dim. G	QTY	Inv. Code	ASSEMBLE ON PARTS	EXTR. DRAWING PART DRAWING
-		T7-CE02-14-05								1			

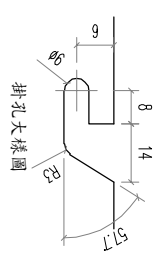
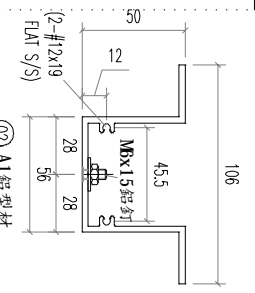
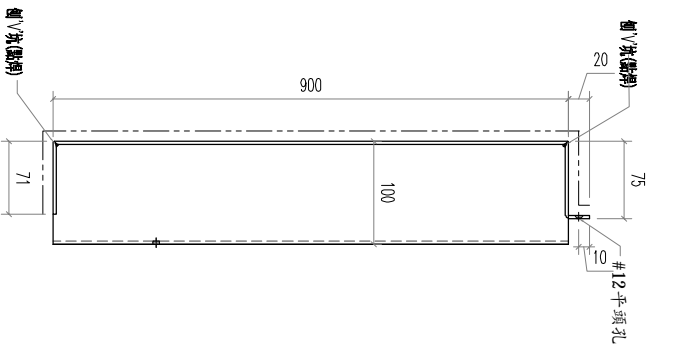
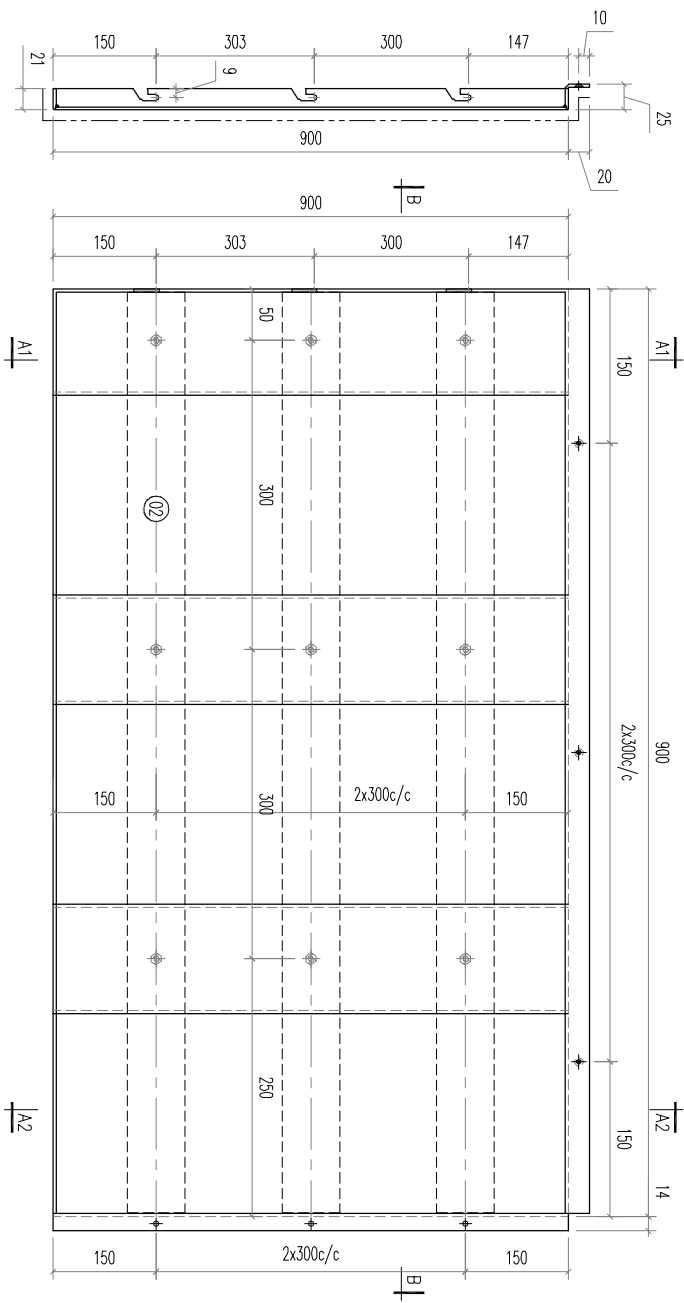
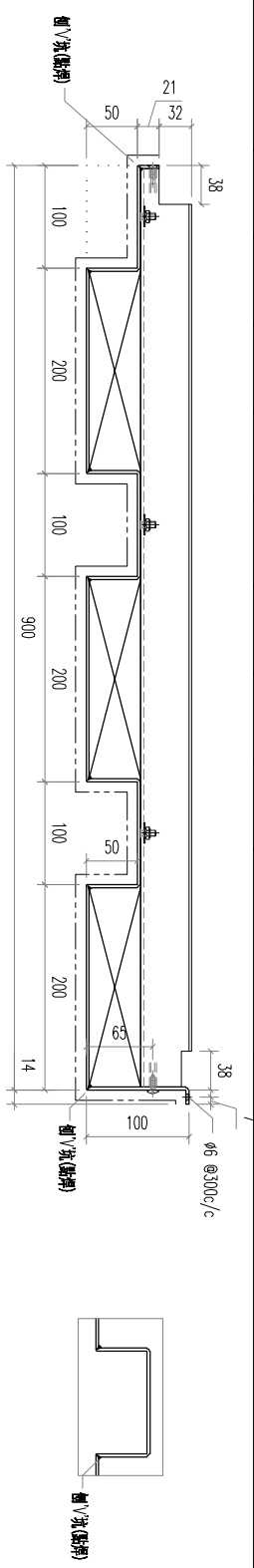

02	A1 鋁型材	893	開料	3	
REV.	DATE	AMENDMENT	REVISED BY		
<p>UNITED ALUMINIUM FABRICATOR LTD.          美特鋁質有限公司          Units 6-8, Sunroy Industrial Centre, 1/F          610 Cho Kwo Ling Road, Kowloon          Tel:23489211-4 Fax:(852)2727666</p>					
PROJECT		JOB NO.		DRAWING TITLE	
J853-PODIUM ALUM CEILING		J853		鋁板天花加工圖	
8 FEATURE CLADDING T7 7/F				3mm THK. ALUM PLATE	
FACTORY		W/CENTRE		CUT ENDS	
01		M&M/S&M/F&B		Angle	
Standard		X X . = ±1		±1'	
Tolerances		X X . X = ±05		Squariness ±1'	
FINISH		DATE		DRAWING NO.	
EC-DG-0334232-201 (AL1)		4/19/2023		T7-CE02-14-05	
POST PAINT		SCALE		SHT.	
PRE PAINT		1:5		-/-	
PART		TRACK TYPE		REV.	
SUB ASSEM.		S.....		-	

REV.	CHECKED DATE BY	PART NUMBER	Dim. A	Dim. B	Dim. C	Dim. D	Dim. E	Dim. F	Dim. G	QTY	Inv. Code	ASSEMBLE ON PARTS	EXTR. DRAWING PART DRAWING
-		T7-CE02-14-06								1			

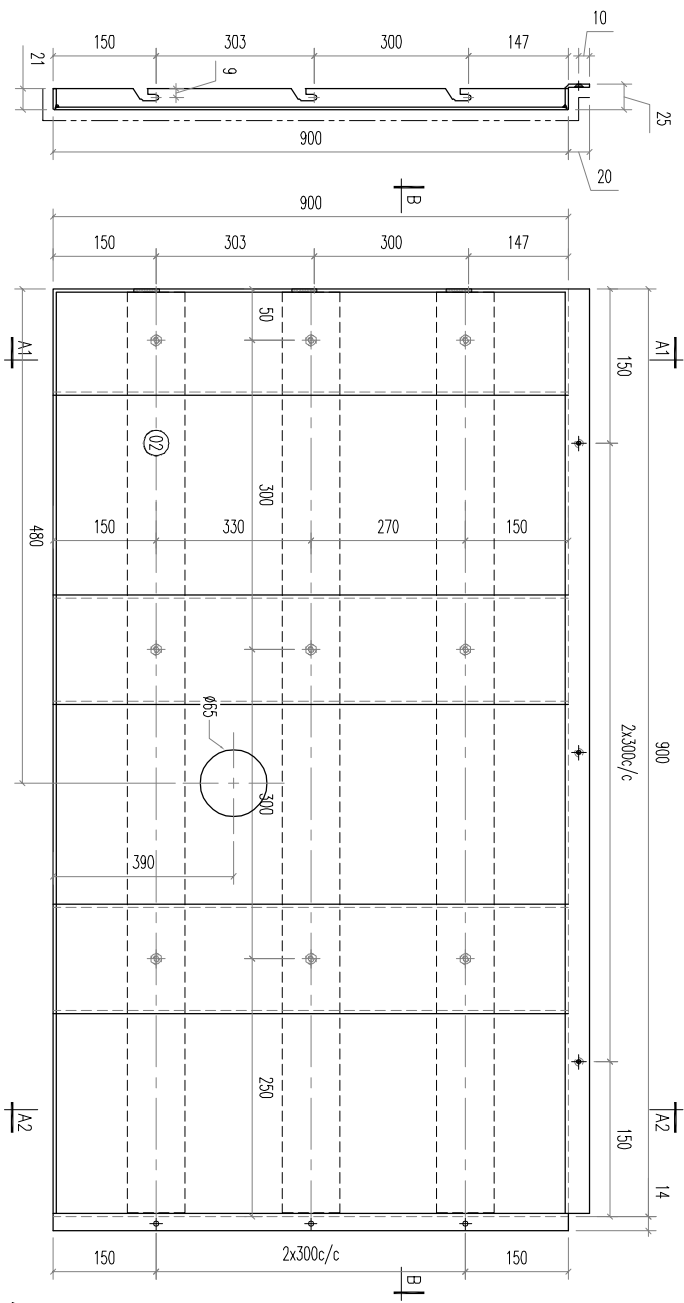
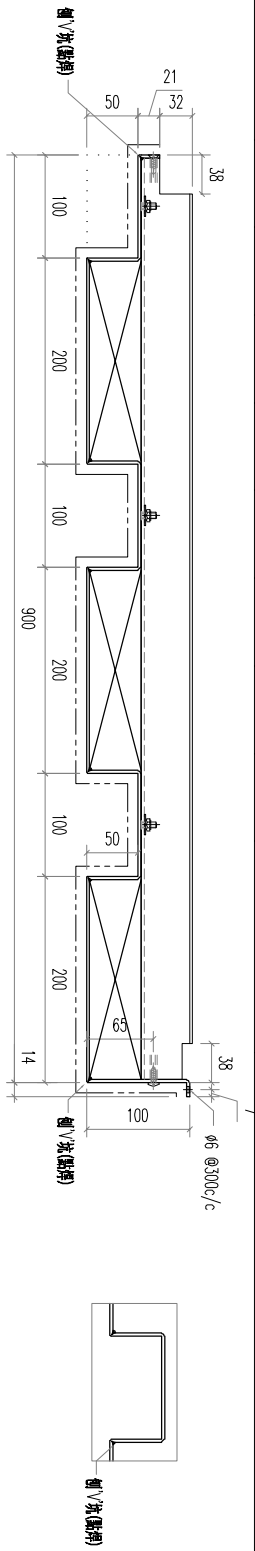

SECTION A2-A2

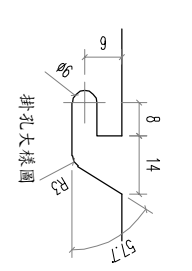
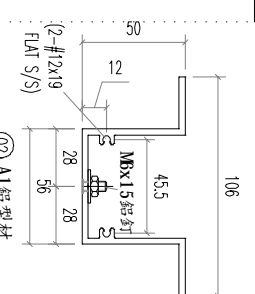
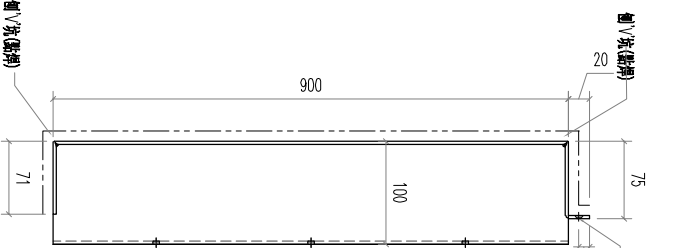

02	A1 铝型材	893	开料	3	
REV.	DATE	AMENDMENT	REVISED BY	备注	
<p>UNITED ALUMINIUM FABRICATOR LTD.          美特铝业有限公司          610 Cho Kwo Ling Road, Kowloon          Tel: 23489211-4 Fax: (852) 2727666</p> <p>PROJECT J853-PODIUM ALUM CEILING          &amp; FEATURE CLADDING T7 7/F</p> <p>JOB NO. J853</p> <p>FACTORY 01 W/CENTRE W&amp;K/S&amp;K&amp;A/F&amp;B CUT ENDS FINISH EC-DG-0334232-201 (AL1) 喷涂 PRE PAINT SCALE 1:5 PART TRACK TYPE S.....</p> <p>Standard X X . = ±1 DATE 4/19/2023          Tolerances X X . X = ±05 Angle Squareness ±1'</p> <p>DRAWING TITLE 铝板天花加工图 3mm THK. ALUM PLATE</p> <p>DRAWING NO. T7-CE02-14-06</p>					

REV.	CHECKED DATE	PART NUMBER	Dim. A	Dim. B	Dim. C	Dim. D	Dim. E	Dim. F	Dim. G	QTY	Inv. Code	ASSEMBLE ON PARTS	EXTR. DRAWING PART DRAWING
-		T7-CE02-14-07								1			

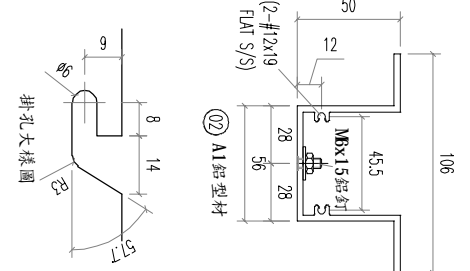
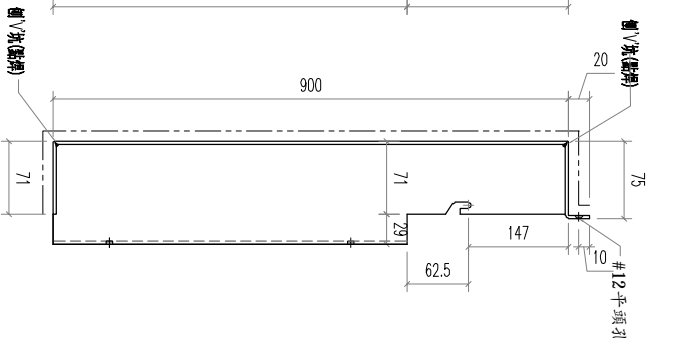
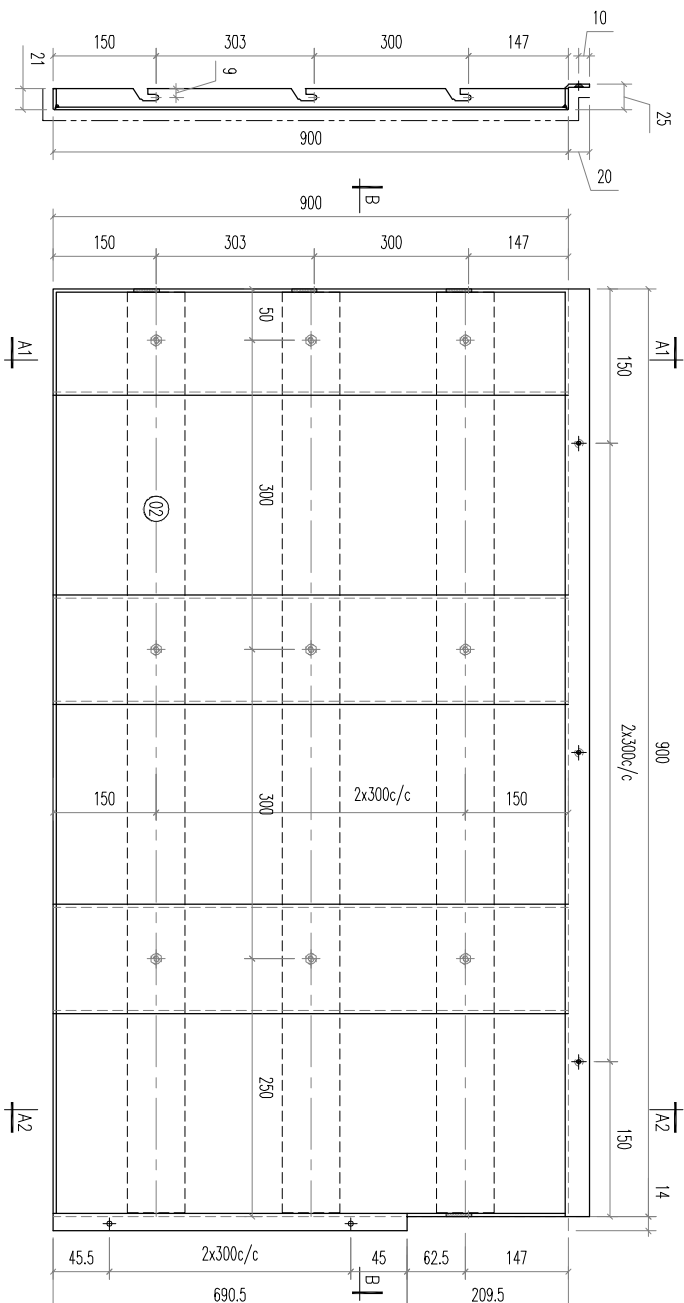
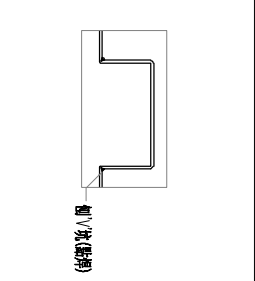
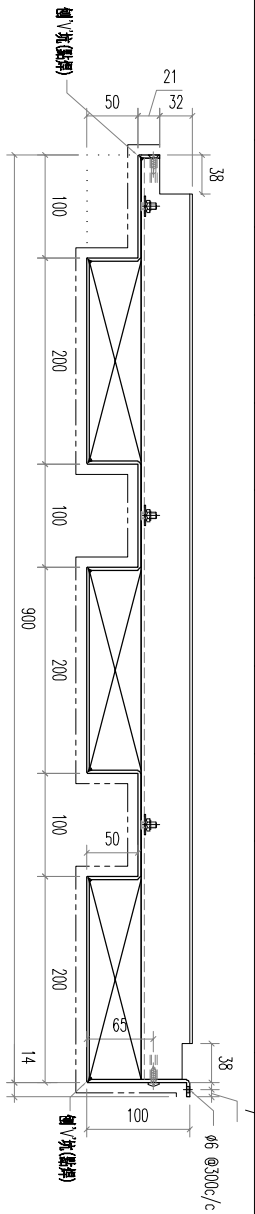

02	A1 铝型材	893	开料	3	
REV	DATE	AMENDMENT	REVISED BY		
<p> <b>美特铝质有限公司</b>  <b>MIDI ALUMINIUM FABRICATOR LTD.</b>          Units 6-8, Sunroy Industrial Centre, 1/F          610 Cho Kwo Ling Road, Kowloon          Tel:23489211-4 Fax:(852)2727666       </p>					
PROJECT		JOB NO.			
J853-PODIUM ALUM CEILING & FEATURE CLADDING T7 7/F		J853			
FACTORY			FINISH		
01			EC-DG-0334232-201 (A1)		
W/CENTRE			DATE		
MOQ/SQA/FAB			4/19/2023		
CUT ENDS			DRAWN		
Angle			YEUNG		
Squariness ±1'			SCALE		
±1'			1:5		
DATE			POST PAINT		
4/19/2023			PRE PAINT		
Tolerances X X . X = ±1			PART		
X X . X = ±05			SUB ASSEM.		
Squariness ±1'			TRACK TYPE		
			S.....		
DRAWING TITLE			DRAWING NO.		
铝板天花加工图			T7-CE02-14-07		
3mm THK. ALUM PLATE			SHT.		
			-/-		
			REV.		
			-		

REV.	CHECKED BY	PART NUMBER	Dim. A	Dim. B	Dim. C	Dim. D	Dim. E	Dim. F	Dim. G	QTY	Inv. Code	ASSEMBLY ON PARTS	EXTR. DRAWING PART DRAWING
-		T7-CE02-14-08								1			

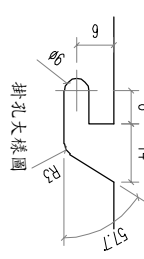
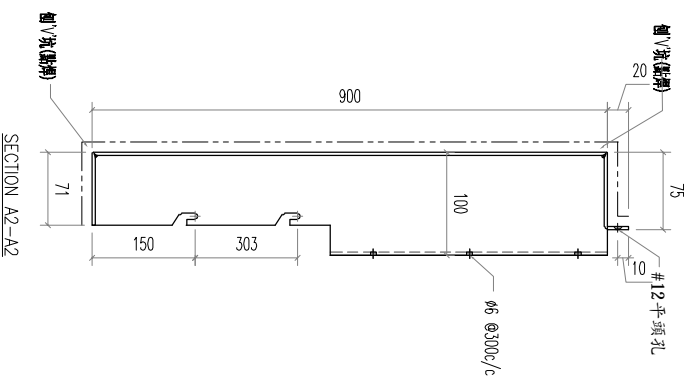
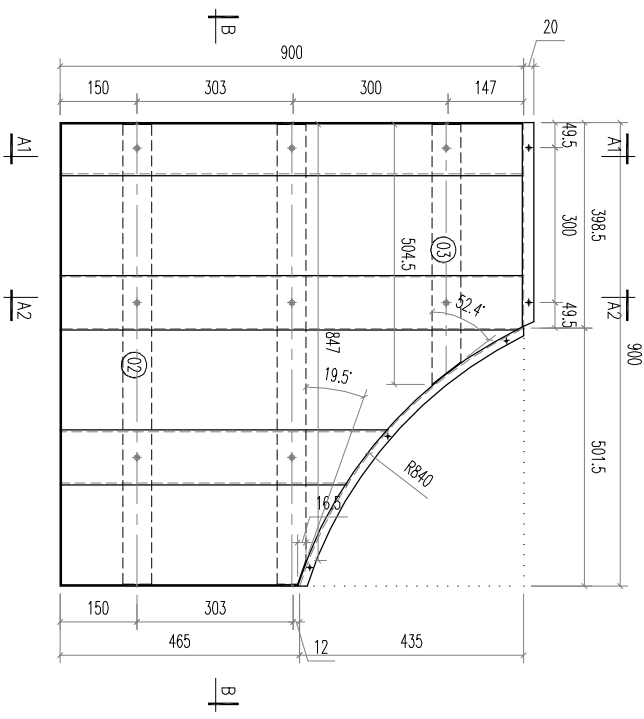
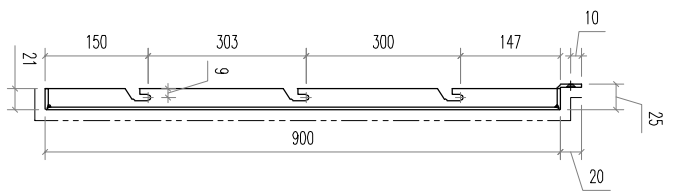
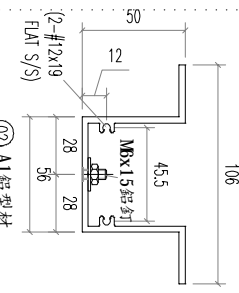
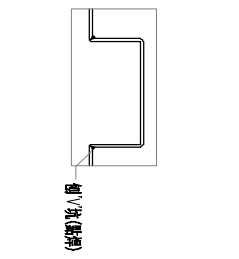
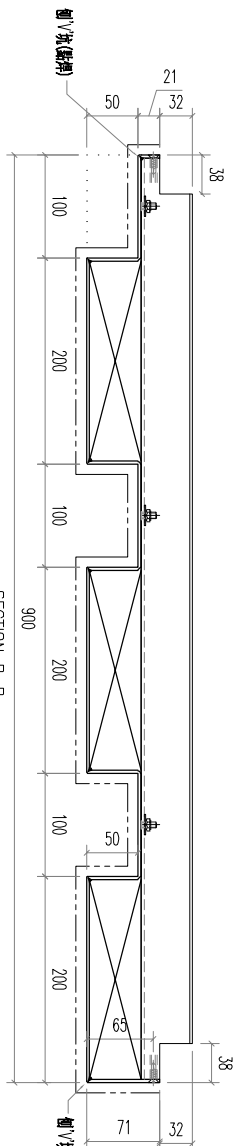

SECTION A2-A2

SECTION A1-A1

REV.	DATE	AMENDMENT	REVISED BY
03		A1 鋁型材	
02		A1 鋁型材	
		材料規格	
		長度	
		配件描述	
		數量	
		备注	

**美特鋁質有限公司**  
MIDI ALUMINIUM FABRICATOR LTD.

Units 6-8, Sunroy Industrial Centre, 1/F  
610 Cho Kwo Ling Road, Kowloon  
Tel: 23489211-4 Fax: (852) 2727666

PROJECT J853-PODIUM ALUM CEILING  
& FEATURE CLADDING T7 7/F

FACTORY	W/CENTRE	CUT ENDS	FINISH	DATE	DRAWN	POST PAINT	PART
01	MAX/SKID/FAB	Angle	EC-DG-0334232-201 (AL1)	4/19/2023	YEUNG	SCALE	SUB ASSEM.
Standard	X X . = ±1	Squareness ±1°				1:5	TRACK TYPE
Tolerances	X X . X = ±05						S.....
DRAWING TITLE	鋁板天花加工圖 3mm THK. ALUM PLATE		DRAWING NO.	T7-CE02-14-08			
JOB NO.	J853						

REV.	CHECKED	PART NUMBER	Dim. A	Dim. B	Dim. C	Dim. D	Dim. E	Dim. F	Dim. G	QTY	Inv. Code	ASSEMBLE ON PARTS	EXTR. DRAWING
-	BAR BY	T7-CE02-14-09								1			PART DRAWING

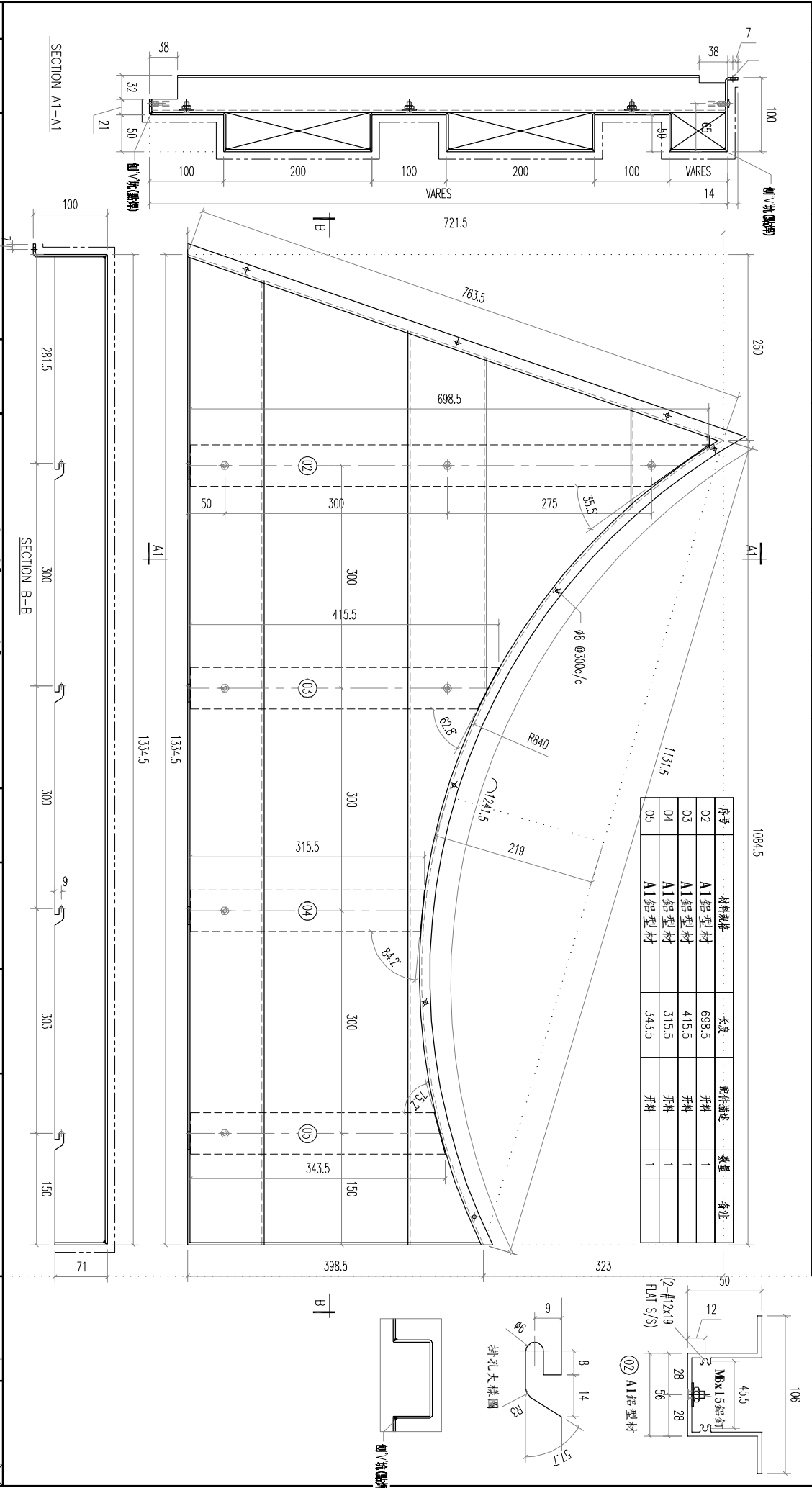

序号	材料规格	长度	零件描述	数量	备注
02	A1 铝型材	698.5	开料	1	
03	A1 铝型材	415.5	开料	1	
04	A1 铝型材	315.5	开料	1	
05	A1 铝型材	343.5	开料	1	

REV.	DATE	AMENDMENT	REVISED BY	PROJECT	JOB NO.	DRAWING TITLE	DRAWING NO.	SHT.	REV.
				8 & FEATURE CLADDING T7 7/F	J853	铝板天花加工图 3mm THK. ALUM. PLATE	T7-CE02-14-09	-/-	-

FACTORY	W/CENTRE	CUT ENDS	FINISH	DATE	SCALE	POST PAINT	PART
01	MAXI/SKBA/FAB		EC-DG-0334232-201 (AL1)	4/19/2023	1:5		

Units 6-8, Sunroy Industrial Centre, 1/F	美特铝质有限公司	喷涂
610 Cha Kwo Ling Road, Kowloon	MIDI ALUMINIUM FABRICATOR LTD.	PRE PAINT
Tel:23489211-4 Fax:(852)2727666		SCALE
		TRACK TYPE



REV.	CHECKED BY	PART NUMBER	Dim. A	Dim. B	Dim. C	Dim. D	Dim. E	Dim. F	Dim. G	QTY	Inv. Code	ASSEMBLY ON PARTS	EXTR. DRAWING PART DRAWING
-		T7-CE02-15-02								1			

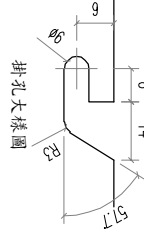
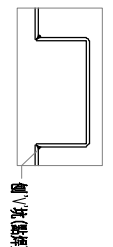
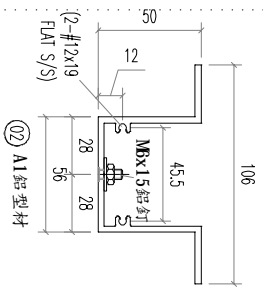
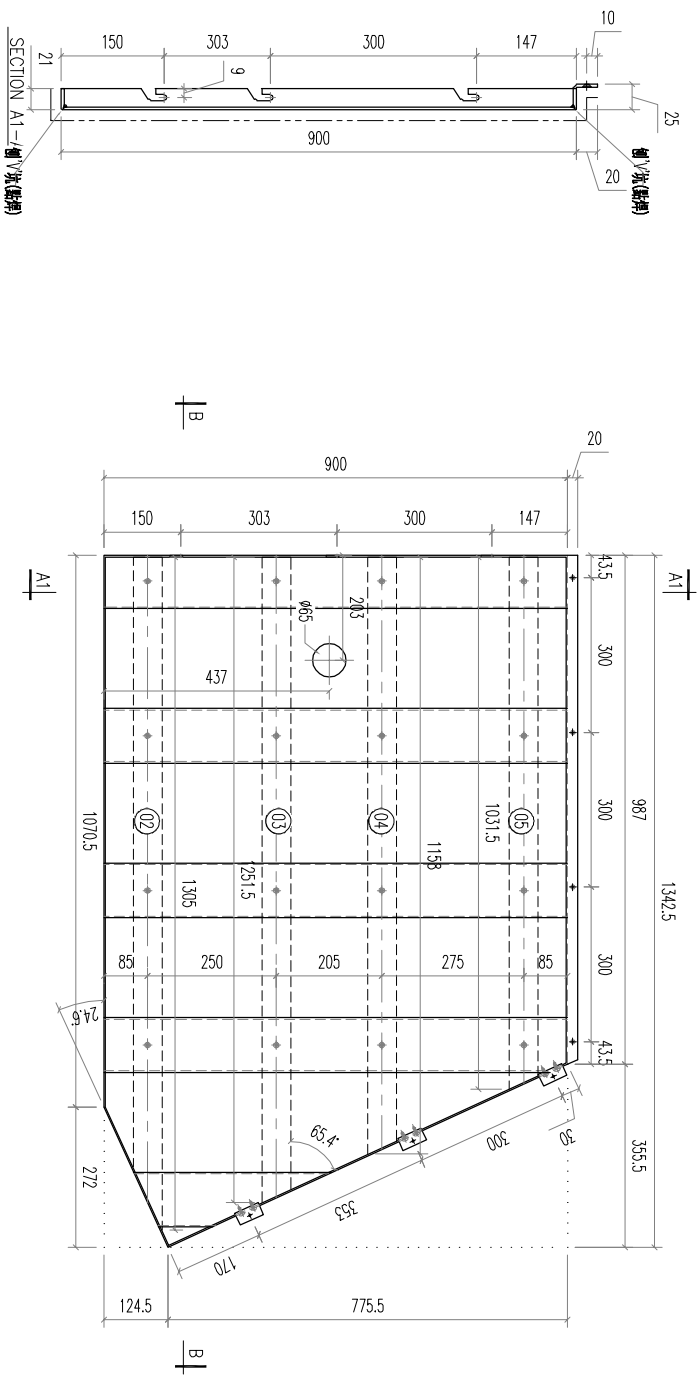
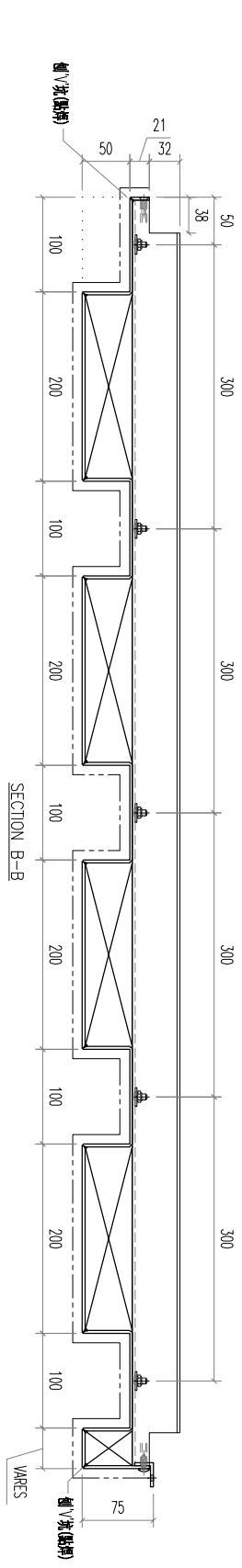

REV	DATE	AMENDMENT	REVISED BY
03		A1 鋁型材	1251.5
02		A1 鋁型材	1305
01		25X20X3mm 鋁角	50

REV	DATE	AMENDMENT	REVISED BY
05		A1 鋁型材	1158
04		A1 鋁型材	1031.5

REV	DATE	AMENDMENT	REVISED BY
03		A1 鋁型材	1251.5
02		A1 鋁型材	1305
01		25X20X3mm 鋁角	50

**美特鋁質有限公司**  
MIDI ALUMINIUM FABRICATOR LTD.  
Units 6-8, Sunroy Industrial Centre, 1/F  
610 Cho Kwo Ling Road, Kowloon  
Tel: 23489211-4 Fax: (852) 27727666

PROJECT	J853-PODIUM ALUM CEILING & FEATURE CLADDING T7 7/F	JOB NO.	J853	DRAWING TITLE	鋁板天花加工圖 3mm THK. ALUM PLATE	DRAWING NO.	T7-CE02-15-02	SHT.	-/-
FACTORY	01	W/CENTRE	MARK/SCBA/FAB	CUT ENDS		FINISH	EC-DG-0334232-201 (AL1)	POST PAINT	PRE PAINT
Standard	X X .	= ±1	Angle	±1'	DATE	4/19/2023	DRAWN	YEUNG	SCALE
Tolerances	X X . X = ±05	Squareness ±1'							1:5

REV.	CHECKED BY	PART NUMBER	Dim. A	Dim. B	Dim. C	Dim. D	Dim. E	Dim. F	Dim. G	QTY	Inv. Code	ASSEMBLY ON PARTS	EXTR. DRAWING PART DRAWING
-		T7-CE02-15-03								1			

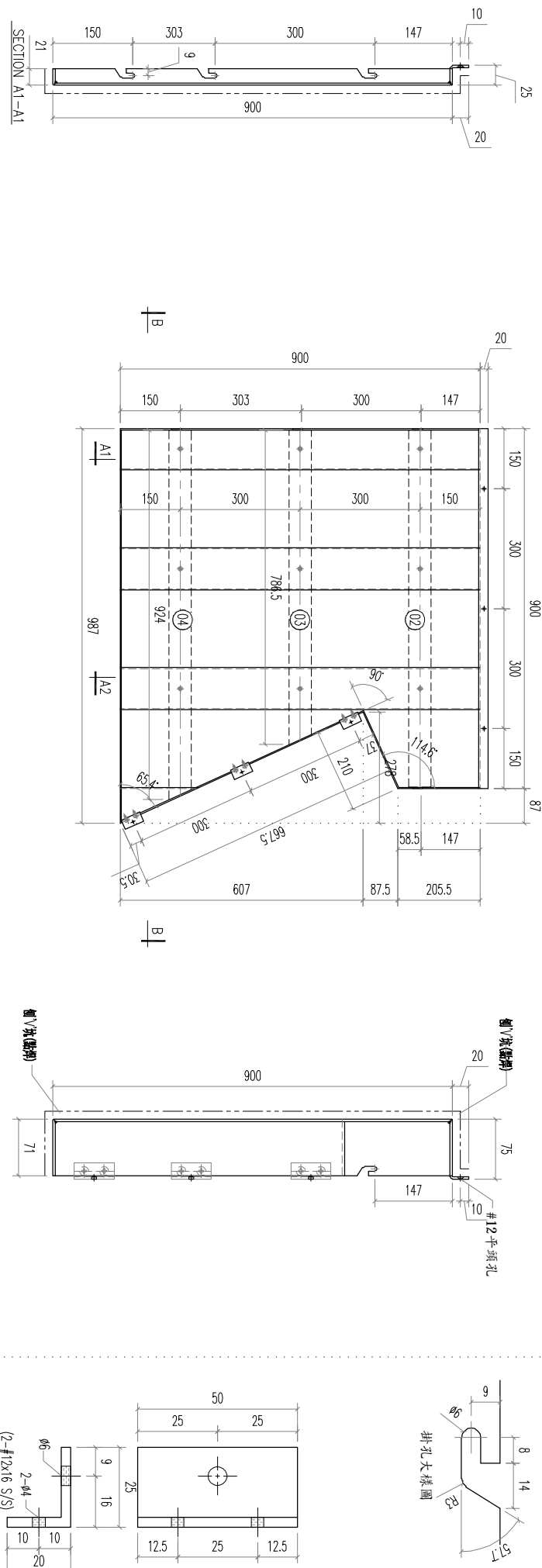
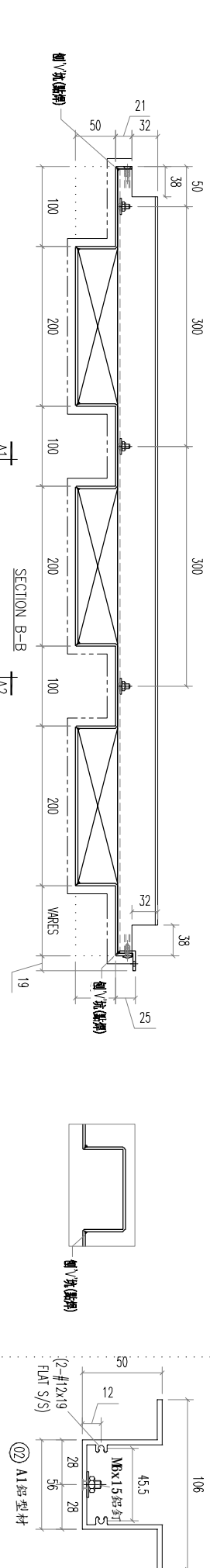

REV.	DATE	AMENDMENT	REVISED BY
04		A1 鋁型材	924
03		A1 鋁型材	786.5
02		A1 鋁型材	893
01		2.5X20X3mm 鋁角	50

序号	材料规格	长度	配件描述	数量	备注

FACTORY	W/CENTRE	CUT ENDS	FINISH	POST PAINT	PART
01	MAX/SKID/FAB		EC-DG-0334232-201 (AL1)		
Standard	X X .	Angle	DATE	SCALE	TRACK TYPE
Tolerances	X X . X = ±1	Squareness ±1°	4/19/2023	1:5	S....

**美特鋁質有限公司**  
MIDI ALUMINIUM FABRICATOR LTD.  
Units 6-8, Sunroy Industrial Centre, 1/F  
610 Cho Kwo Ling Road, Kowloon  
Tel: 23489211-4 Fax: (852) 27727666

PROJECT J853-PODIUM ALUM CEILING  
& FEATURE CLADDING T7 7/F

JOB NO. J853

DRAWING TITLE 鋁板天花加工圖  
3mm THK. ALUM PLATE

DRAWING NO. T7-CE02-15-03

DRAMA YOUNG

噴漆 (AL1)

PRE PAINT

SCALE 1:5

PART

SUB ASSEM.

TRACK TYPE

S....

SHT. -/-

REV. -

REV.	CHECKED DATE BY	PART NUMBER	Dim. A	Dim. B	Dim. C	Dim. D	Dim. E	Dim. F	Dim. G	QTY	Inv. Code	ASSEMBLE ON PARTS	EXTR. DRAWING PART DRAWING
1		T7-CE02-15-04								1			

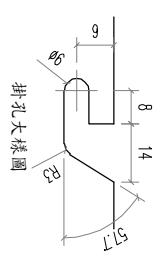
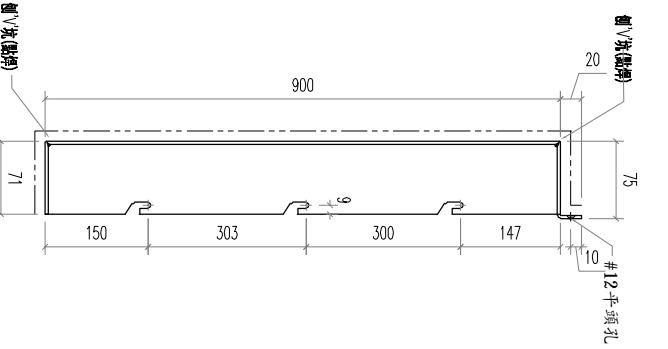
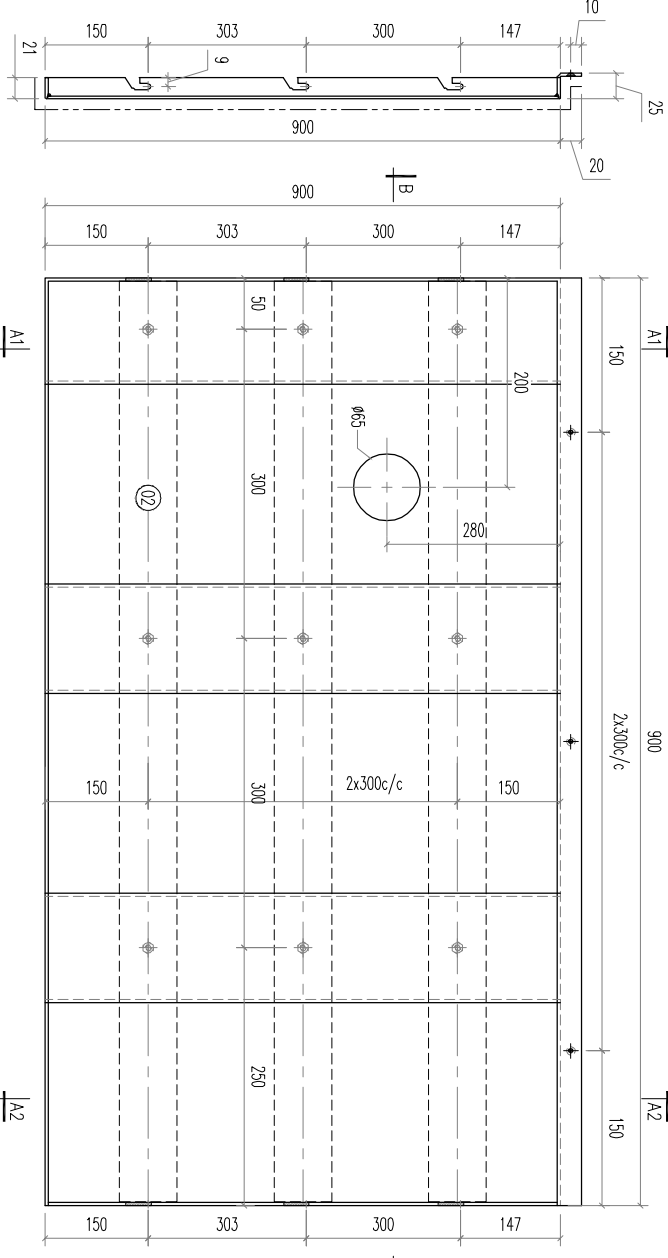
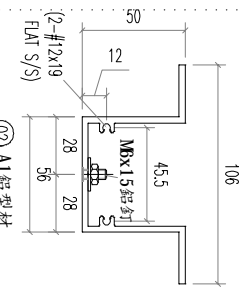
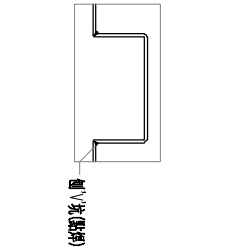
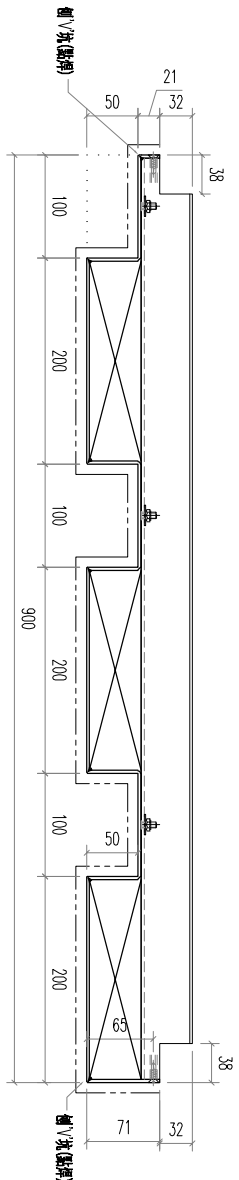

SECTION A1-A1

SECTION A2-A2

02	A1 鋁型材	893	開料	3	
REV.	DATE	AMENDMENT	REVISED BY		
<p><b>美特鋁質有限公司</b>  <b>MIDI ALUMINIUM FABRICATOR LTD.</b>          Units 6-8, Sunroy Industrial Centre, 1/F          610 Cha Kwo Ling Road, Kowloon          Tel: 23489211-4 Fax: (852) 27727666</p>					
<p>PROJECT: J853-PODIUM ALUM CEILING &amp; FEATURE CLADDING T7 7/F          JOB NO.: J853</p>					
FACTORY 01		W/CENTRE MOK/SOKA/FAB		CUT ENDS	
Standard		X X . = ±1		Angle	
Tolerances		X X . X = ±05		Squarness ±1°	
DATE 4/19/2023		FINISH EC-06-0334232-201 (AL1)		噴漆	
DRAWING TITLE 鋁板天花加工圖		DRAWING NO. T7-CE02-15-04		YEUNG	
3mm THK. ALUM PLATE		POST PAINT		SCALE 1:5	
		PART		SHT. -/-	
		SUB ASSEM.		REV. -	
		TRACK TYPE			
		S.....			

REV.	CHECKED DATE BY	PART NUMBER	Dim. A	Dim. B	Dim. C	Dim. D	Dim. E	Dim. F	Dim. G	Dim. H	QTY	Inv. Code	ASSEMBLY ON PARTS	EXTR. DRAWING PART DRAWING
-		T7-CE02-15-05									1			

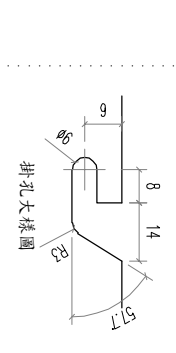
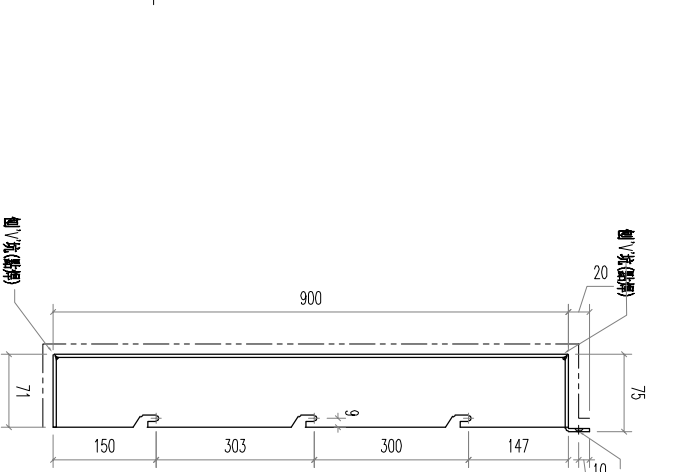
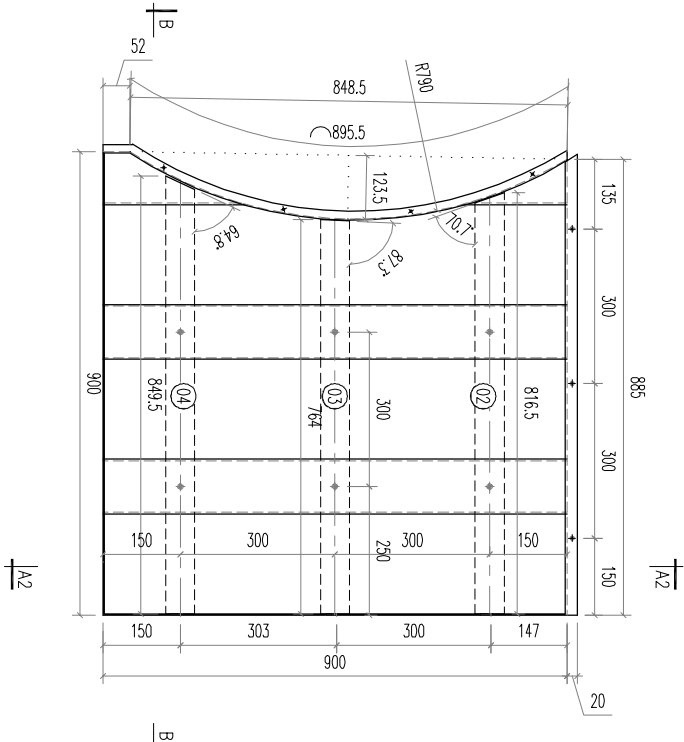
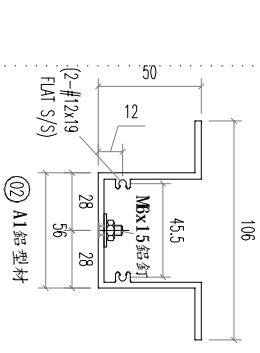
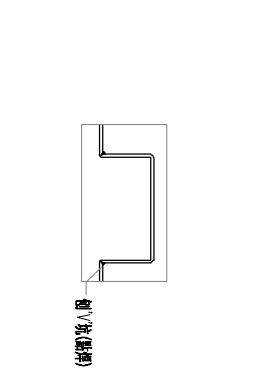
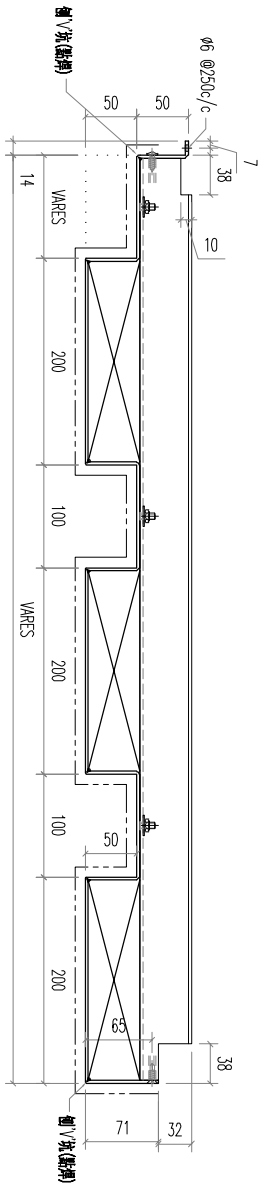

REV	DATE	AMENDMENT	REVISED BY			
04		A1 鋁型材	849.5	開料	1	
03		A1 鋁型材	764	開料	1	
02		A1 鋁型材	816.5	開料	1	
		材料規格	長度	配件描述	數量	备注

**美特鋁質有限公司**  
MIDI ALUMINIUM FABRICATOR LTD.

Units 6-8, Sunray Industrial Centre, 1/F  
610 Cho Kwo Ling Road, Kowloon  
Tel: 23489211-4 Fax: (852) 27727666

PROJECT J853-PODIUM ALUM CEILING  
& FEATURE CLADDING T7 7/F

FACTORY	W/CENTRE MARK/SCBA/FAB	CUT ENDS	FINISH	DATE	DRAWN	SCALE	POST PAINT	PART	SHT.	REV.
01	X X . = ±1 X X . X = ±05	Angle Squariness ±1°	EC-DG-0334232-Z01 (AL1)	4/19/2023	YEUNG	1:5			-/-	-

REV.	CHECKED DATE	PART NUMBER	Dim. A	Dim. B	Dim. C	Dim. D	Dim. E	Dim. F	Dim. G	QTY	Inv. Code	ASSEMBLE ON PARTS	EXTR. DRAWING PART DRAWING
-		T7-CE02-15-06								1			

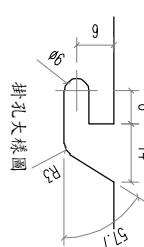
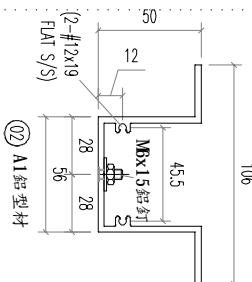
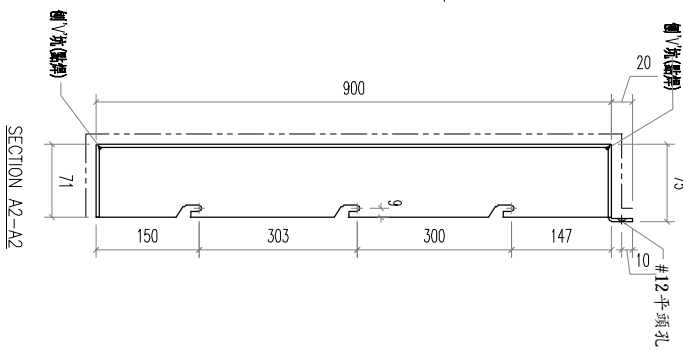
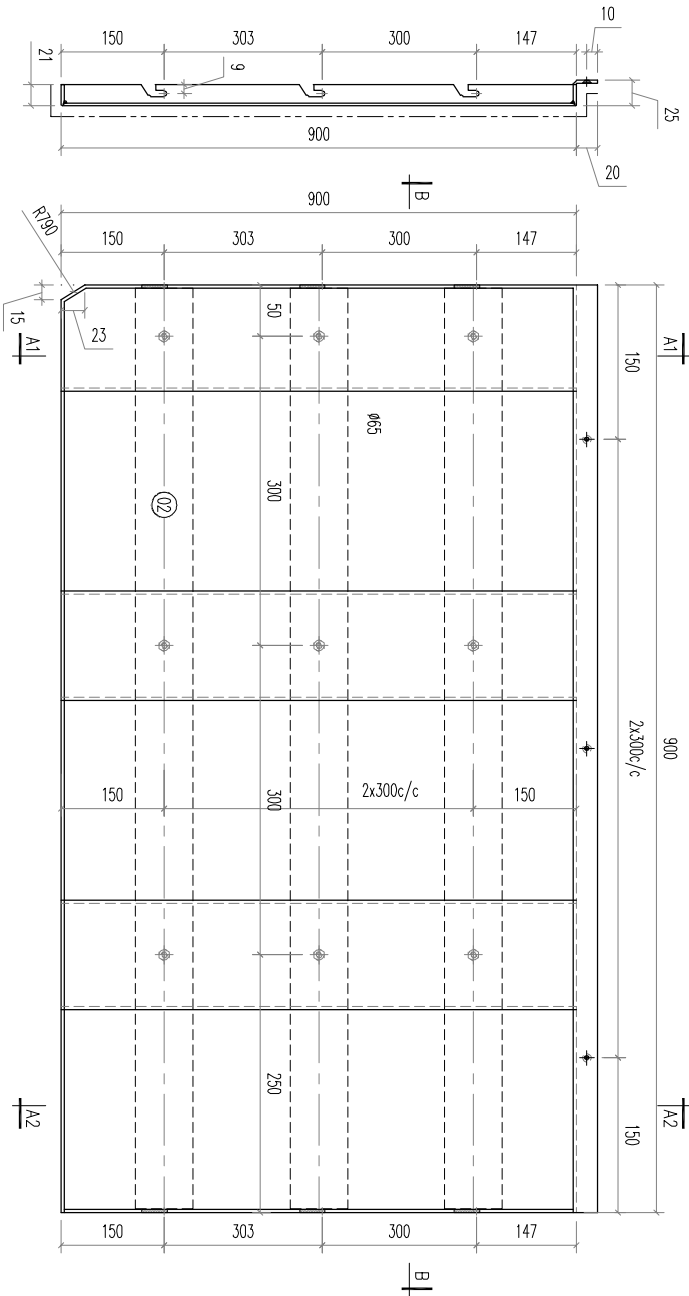
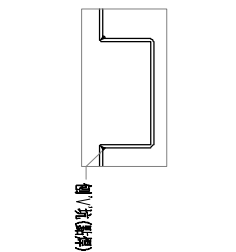
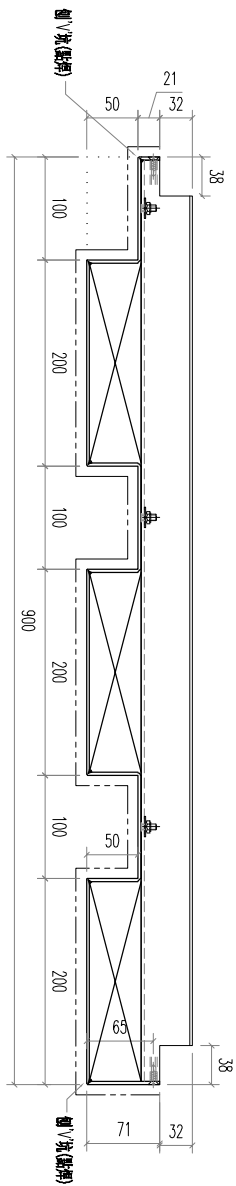

02	A1 鋁型材	893	開料	3	
REV.	DATE	AMENDMENT	REVISED BY		
<p>UNITED ALUMINIUM FABRICATOR LTD.          美特鋁質有限公司          610 Cho Kwo Ling Road, Kowloon          Tel: 23489211-4 Fax: (852) 27727666</p> <p>PROJECT J853-PODIUM ALUM CEILING &amp; FEATURE CLADDING T7 7/F          JOB NO. J853</p> <p>FACTORY 01 W/CENTRE WCKX/SKBA/FAB CUT ENDS Standard X X . X = ±1 Angle Squariness ±1° DATE 4/19/2023 FINISH EC-DG-0334232-201 (AL1) 噴漆 DRAWN YEUNG POST PAINT PRE PAINT SCALE 1:5 PART TRACK TYPE S.....</p> <p>DRAWING TITLE 鋁板天花加工圖 3mm THK. ALUM PLATE DRAWING NO. T7-CE02-15-06 SHT. -/- REV. -</p>					

REV.	CHECKED DATE	PART NUMBER	Dim. A	Dim. B	Dim. C	Dim. D	Dim. E	Dim. F	Dim. G	QTY	Inv. Code	ASSEMBLE ON PARTS	EXTR. DRAWING PART DRAWING
-		T7-CE02-15-07								1			

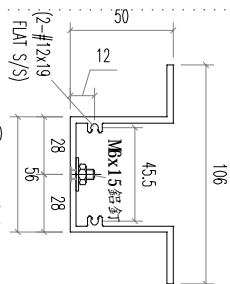
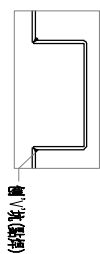
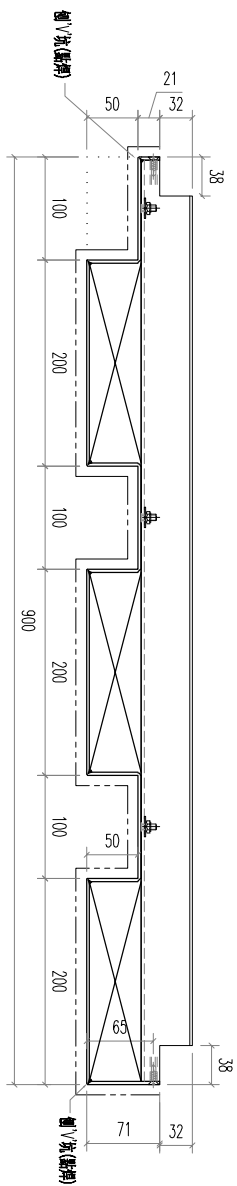

② A1 鋁型材

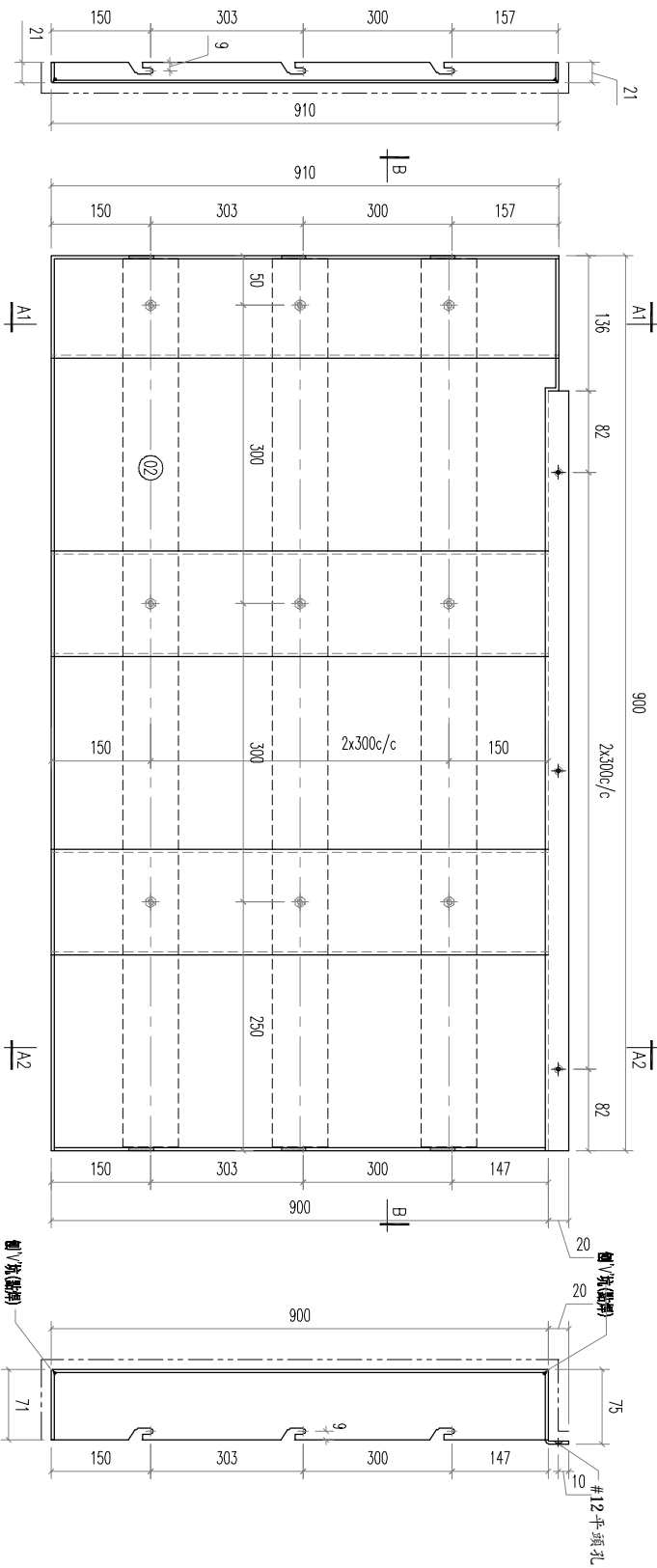
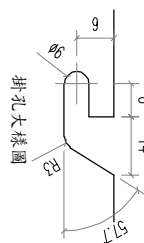

SECTION A2-A2

SECTION A1-A1

02	A1 鋁型材	893	開料	3	
REV.	材料規格	長度	配件描述	數量	备注
REV.	DATE	AMENDMENT	REVISED BY		
<p><b>美特鋁質有限公司</b>  <b>MIDI ALUMINIUM FABRICATOR LTD.</b>          Units 6-8, Sunroy Industrial Centre, 1/F          610 Cho Kwo Ling Road, Kowloon          Tel:23489211-4 Fax:(852)2727666</p> <p>PROJECT <b>J853-PODIUM ALUM CEILING</b> JOB NO. <b>J853</b>  <b>&amp; FEATURE CLADDING T7 7/F</b></p> <p>FACTORY <b>01</b> W/CENTRE <b>MOCK/SKID/FAB</b> CUT ENDS <b>Angle</b> FINISH <b>EC-DG-0334232-201 (AL1)</b> 噴漆          Standard X X . = ±1 DATE <b>4/19/2023</b>          Tolerances X X . X = ±05 Squariness ±1°          DRAWING TITLE <b>鋁板天花加工圖</b> DRAWING NO. <b>T7-CE02-15-07</b>  <b>3mm THK. ALUM PLATE</b> DRAWN <b>YEUNG</b> SCALE <b>1:5</b> PART <b>POST PAINT</b>          DRAWING NO. <b>T7-CE02-15-07</b> TRACK TYPE <b>S.....</b></p>					

REV. CHECKED BAR BY	PART NUMBER	Dim. A	Dim. B	Dim. C	Dim. D	Dim. E	Dim. F	Dim. G	QTY	Inv. Code	ASSEMBLE ON PARTS	EXTR. DRAWING PART DRAWING
-	T7-CE02-15-08								1			

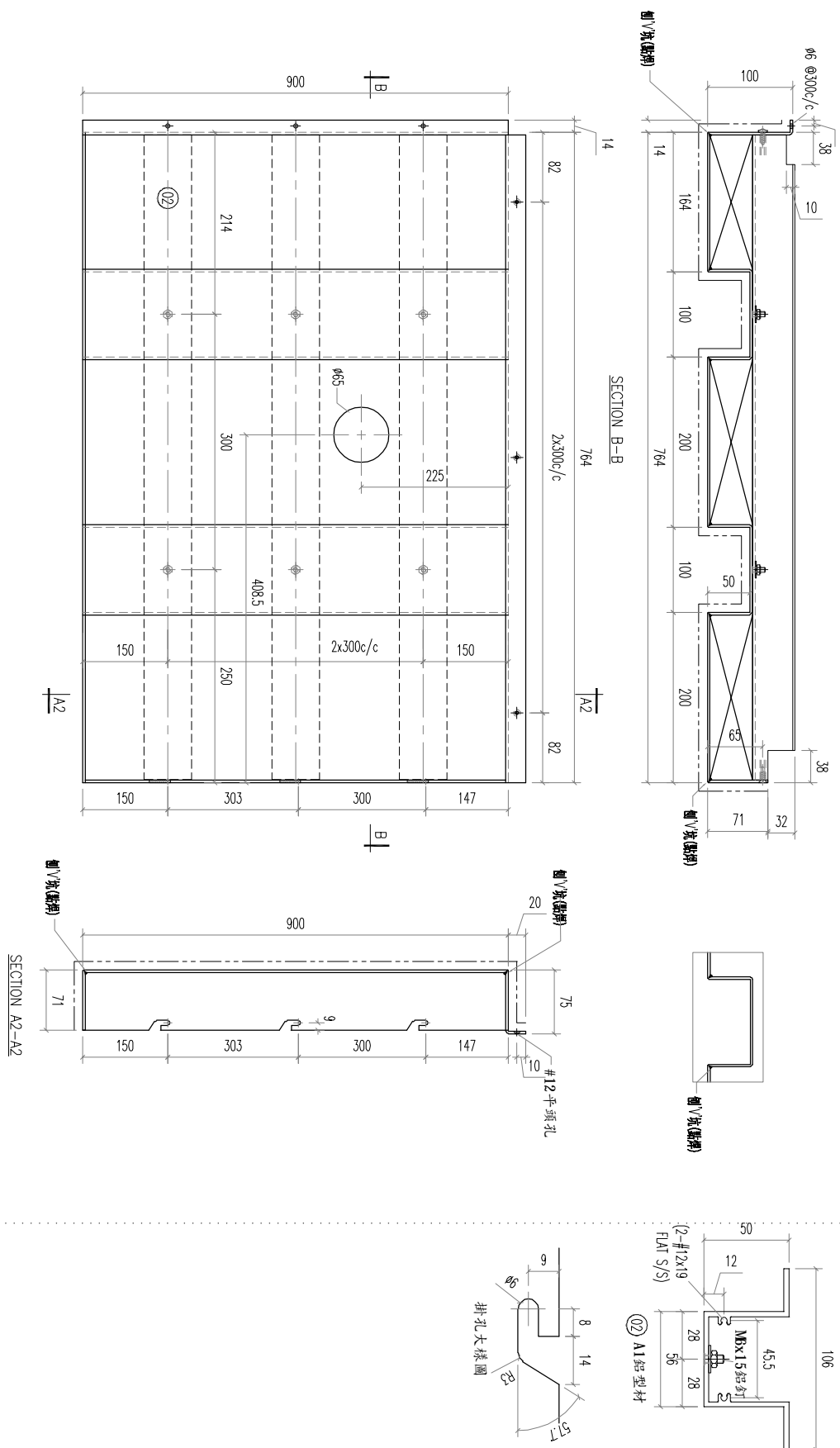

REV. DATE	AMENDMENT	REVISED BY	REVISION	REVISION DESCRIPTION	QTY	REVISION	REVISION DESCRIPTION	QTY			
02	A1 鋁型材	757	3	開料							
	材料規格	長度	配件描述	數量	備註						
<p>PROJECT J853-PODIUM ALUM CEILING &amp; FEATURE CLADDING T7 7/F</p>											
<p>UNITED ALUMINIUM FABRICATOR LTD. MIDI ALUMINIUM FABRICATOR LTD. Units 6-8, Sunray Industrial Centre, 1/F 610 Cha Kwo Ling Road, Kowloon Tel: 23489211-4 Fax: (852) 27727666</p> <p>FACTORY 01 W/CENTRE MB04/S03A/FAB CUT ENDS Standard X X . X X . X = ±1 Angle Squareness ±1° DATE 4/19/2023 FINISH EC-06-0334232-201 (AL1) 噴漆 DRAWN YEUNG SCALE 1:5 POST PAINT PRE PAINT PART SUB ASSEM. TRACK TYPE S.....</p>											





REV.	CHECKED	PART NUMBER	Dim. A	Dim. B	Dim. C	Dim. D	Dim. E	Dim. F	Dim. G	QTY	Inv. Code	ASSEMBLE ON PARTS	EXTR. DRAWING
-	BAR BY	T7-CE02-16-01								1			PART DRAWING

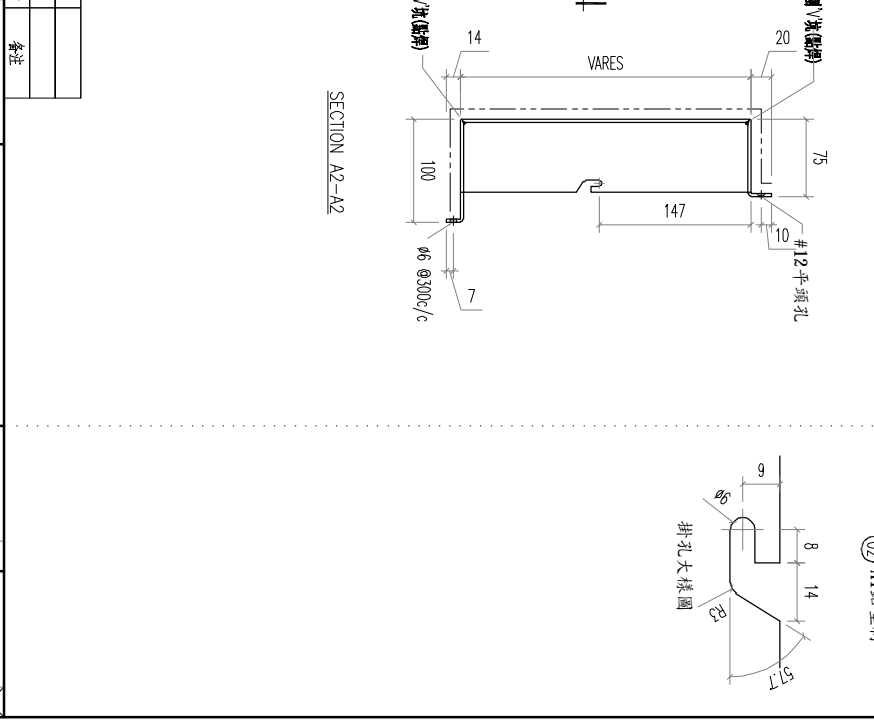
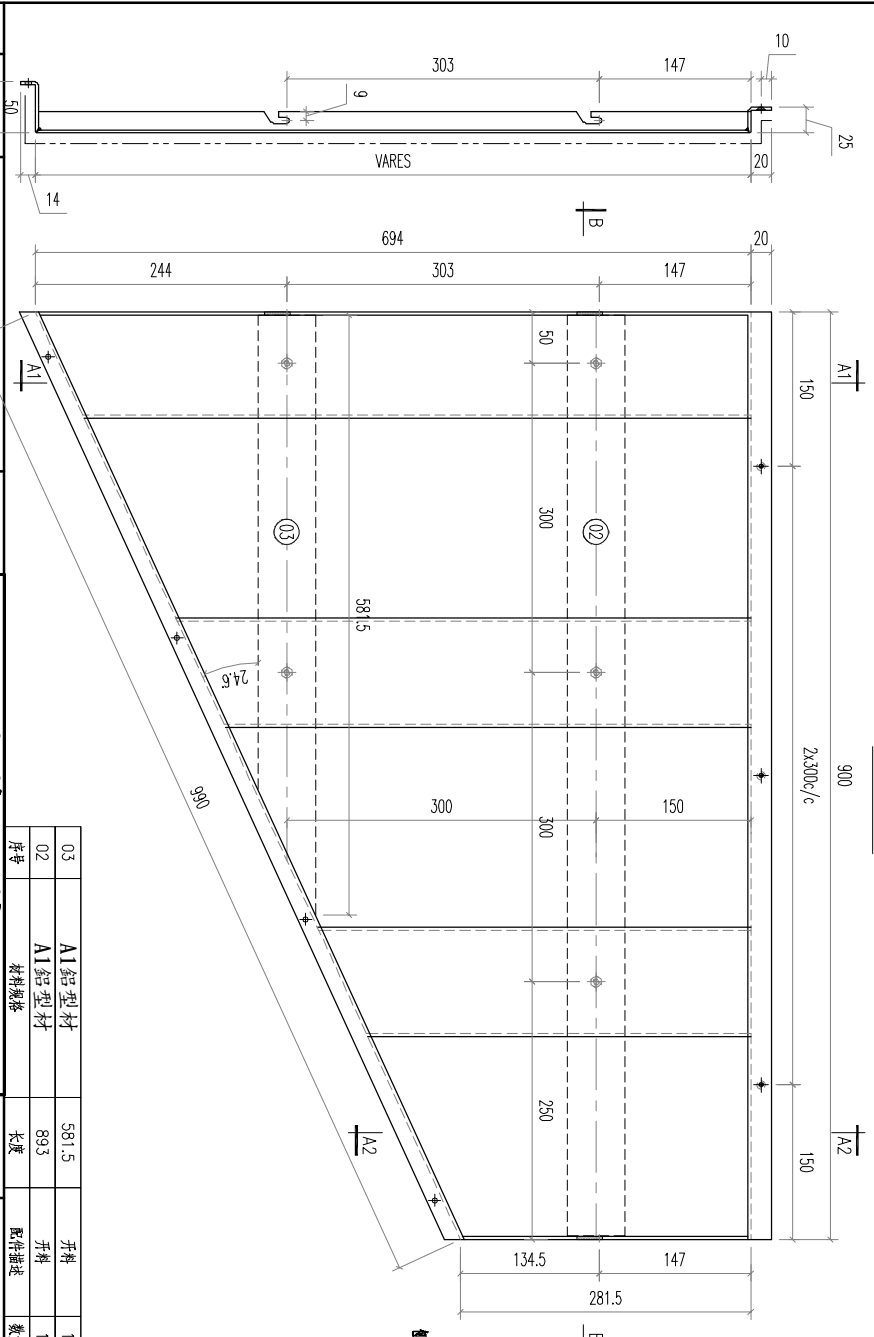
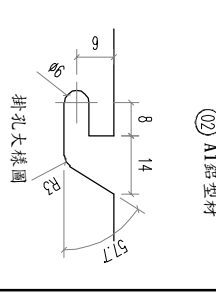
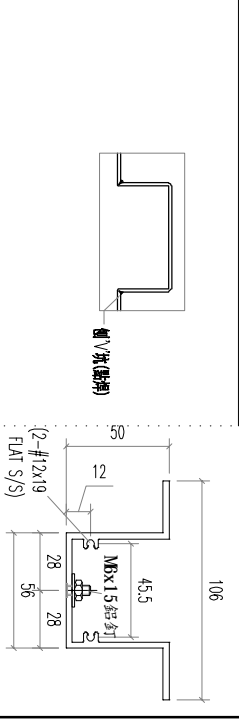
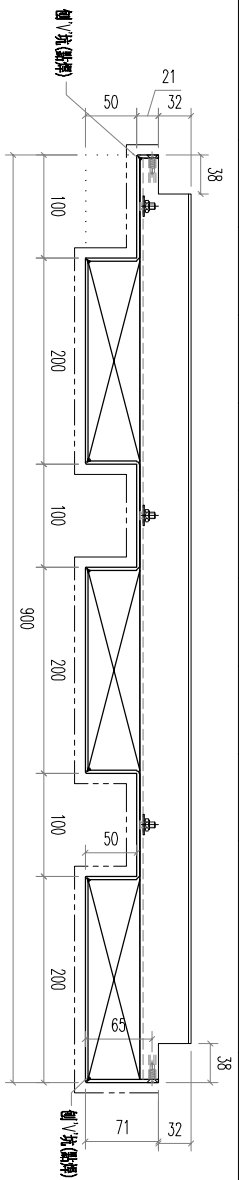

料号	材料规格
03	A1铝型材
02	A1铝型材

长度	开料	开料	配件描述	数量	备注
581.5	1	1			
893	1	1			

FACTORY	W/CENTRE	CUT ENDS	FINISH	DATE	POST PAINT	PART
01	W/CENTRE		EC-DG-0334232-201 (A1)	4/19/2023		

**美特铝质有限公司**  
MIDI ALUMINIUM FABRICATOR LTD.  
Units 6-8, Sunray Industrial Centre, 1/F  
610 Cha Kwo Ling Road, Kowloon  
Tel:23489211-4 Fax:(852)2727666

REV.	DATE	AMENDMENT	REVISED BY	PROJECT	JOB NO.	DRAWING TITLE	DRAWING NO.	POST PAINT	PART	SHT.	REV.
				J853-PODIUM ALUM CEILING & FEATURE CLADDING T7 7/F	J853	铝板天花加工图 3mm THK. ALUM PLATE	T7-CE02-16-01			-/-	-

REV.	CHECKED	PART NUMBER	Dim. A	Dim. B	Dim. C	Dim. D	Dim. E	Dim. F	Dim. G	QTY	Inv. Code	ASSEMBLE ON PARTS	EXTR. DRAWING
1	BAR BY	T7-CE02-16-02								1			PART DRAWING

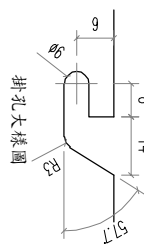
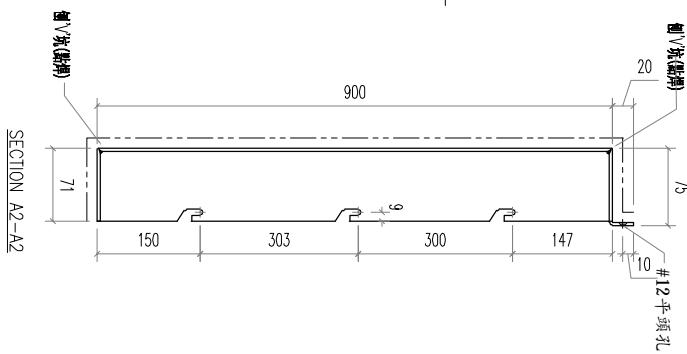
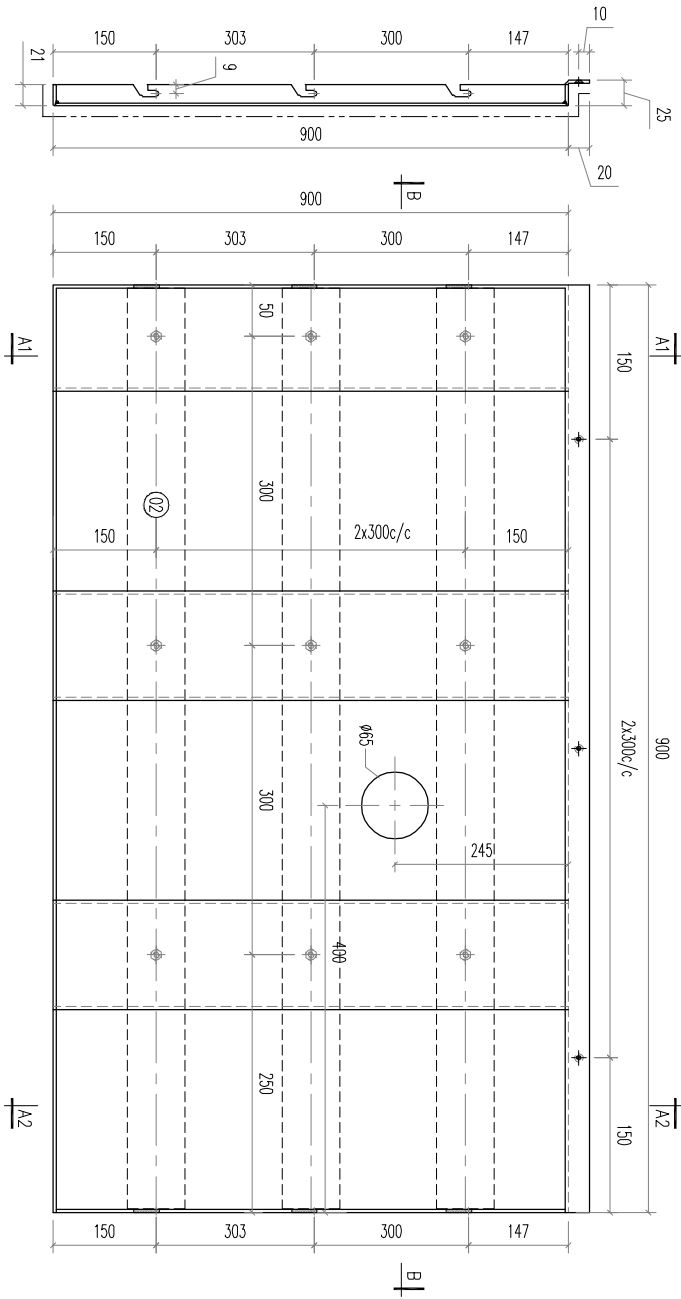
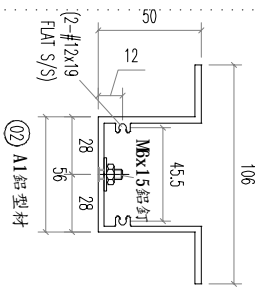
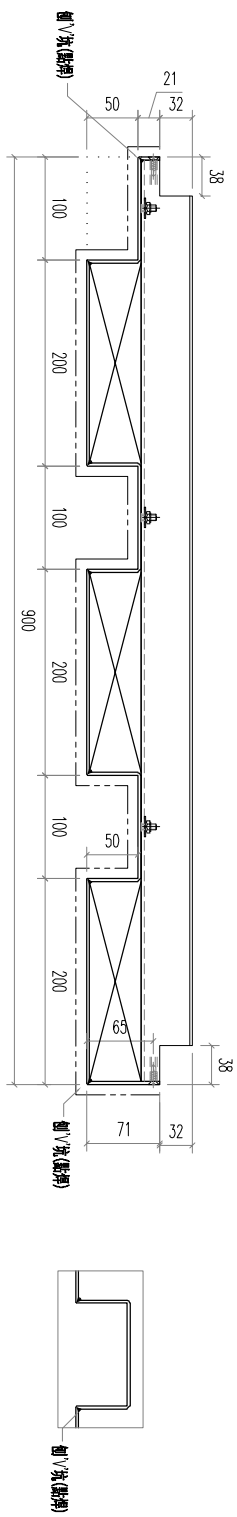

SECTION A1-A1

SECTION A2-A2

02	A1 鋁型材	893	開料	3	
序號	材料規格	長度	配件描述	數量	备注

**美特鋁質有限公司**  
MIDI ALUMINIUM FABRICATOR LTD.  
Units 6-8, Sunroy Industrial Centre, 1/F  
610 Cha Kwo Ling Road, Kowloon  
Tel: 23489211-4 Fax: (852) 27727666

REV.	DATE	AMENDMENT	REVISED BY

PROJECT J853-PODIUM ALUM CEILING  
& FEATURE CLADDING T7 7/F

FACTORY	W/CENTRE	CUT ENDS	FINISH
01	MAX/SDBA/FAB	Angle	EC-DG-0334232-201 (AL1)
Standard	X X . = ±1	Squareness ±1°	DATE 4/19/2023
Tolerances	X X . X = ±05		DRAWN YEUNG

DRAWING TITLE	DRAWING NO.	POST PAINT	PART
鋁板天花加工圖 3mm THK. ALUM PLATE	T7-CE02-16-02	SCALE 1:5	TRACK TYPE S.....
JOB NO. J853	SHT. -/-		REV. -

REV.	CHECKED DATE BY	PART NUMBER	Dim. A	Dim. B	Dim. C	Dim. D	Dim. E	Dim. F	Dim. G	QTY	Inv. Code	ASSEMBLY ON PARTS	EXTR. DRAWING PART DRAWING
-		T7-CE02-16-03								1			

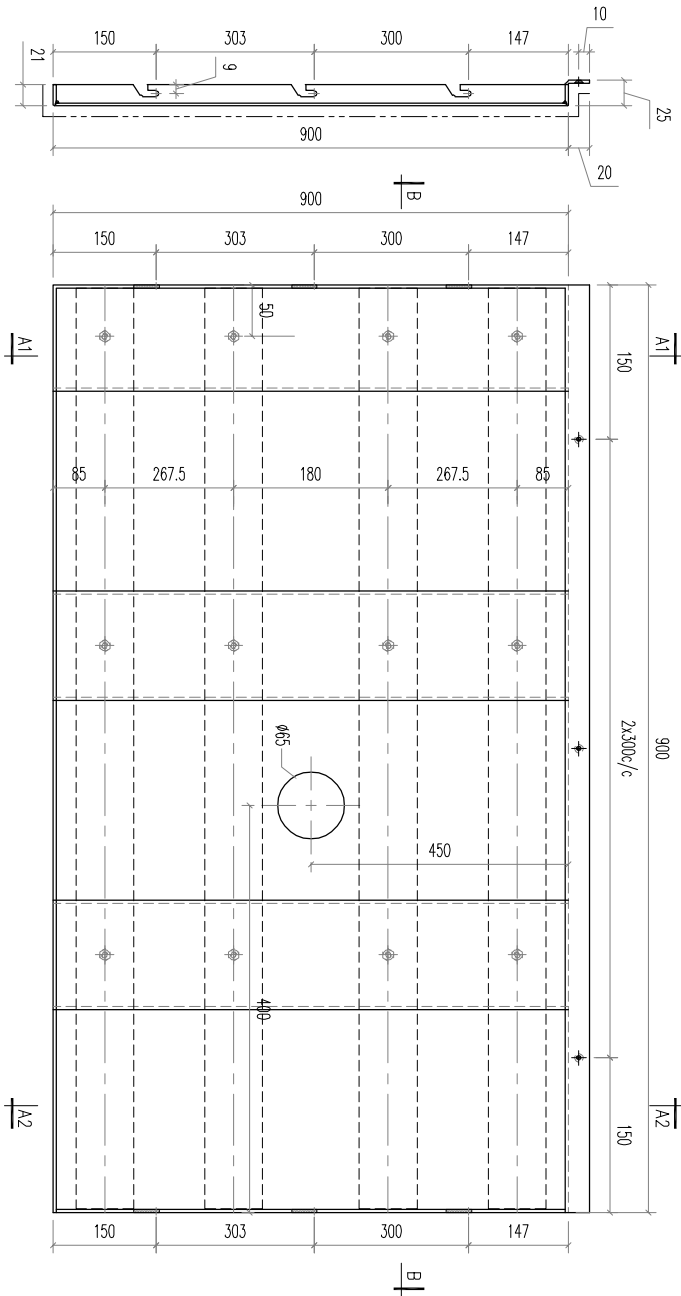
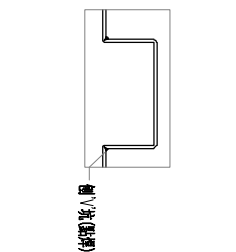
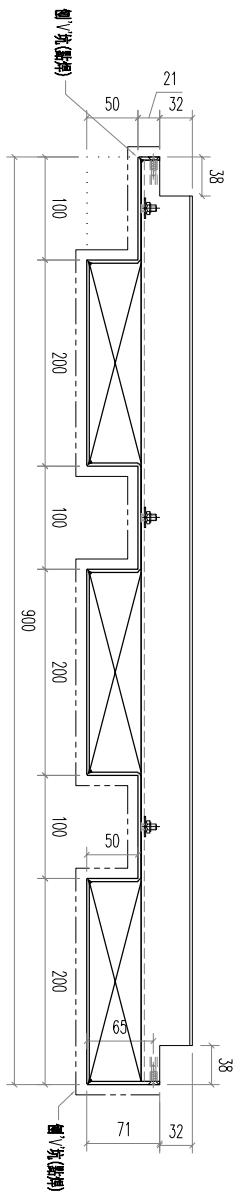

SECTION A2-A2

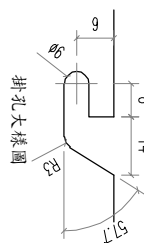
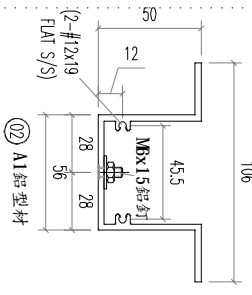
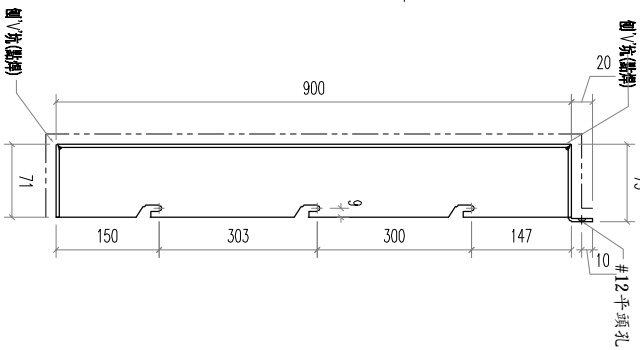

02	A1 鋁型材	893	開料	4	
REV.	材料規格	長度	配件描述	數量	备注
REV.	DATE	AMENDMENT	REVISED BY		
<p>  <b>美特鋁質有限公司</b>  <b>MIDI ALUMINIUM FABRICATOR LTD.</b>          Units 6-8, Sunray Industrial Centre, 1/F          610 Cho Kwo Ling Road, Kowloon          Tel: 23489211-4 Fax: (852) 2727666       </p> <p>         PROJECT <b>J853-PODIUM ALUM CEILING</b> JOB NO. <b>J853</b>  <b>&amp; FEATURE CLADDING T7 7/F</b> </p> <p>         Standard X X . = ±1          Tolerances X X . X = ±05          Angle Squareness ±1°       </p> <p>         FACTORY 01 W/CENTRE MBX/SKBA/FAB CUT ENDS FINISH EC-DG-0334232-201 (AL1) 噴漆          DATE 4/19/2023 DRAWN YEUNG POST PAINT SCALE 1:5 PART SUB ASSEM.          DRAWING TITLE <b>鋁板天花加工圖</b> 3mm THK. ALUM PLATE DRAWING NO. T7-CE02-16-03 SHT. -/- REV. -       </p>					

REV.	CHECKED DATE BY	PART NUMBER	Dim. A	Dim. B	Dim. C	Dim. D	Dim. E	Dim. F	Dim. G	QTY	Inv. Code	ASSEMBLE ON PARTS	EXTR. DRAWING PART DRAWING
-		T7-CE02-16-04								1			

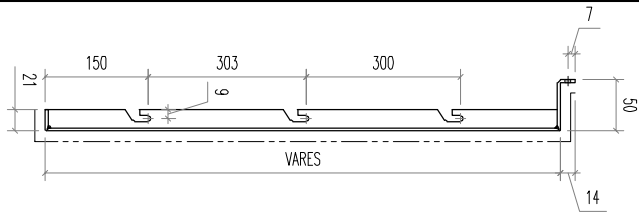
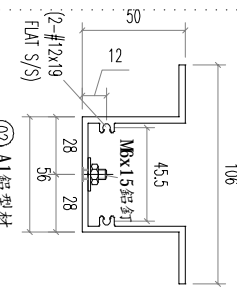
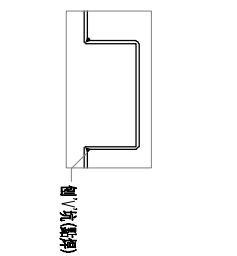
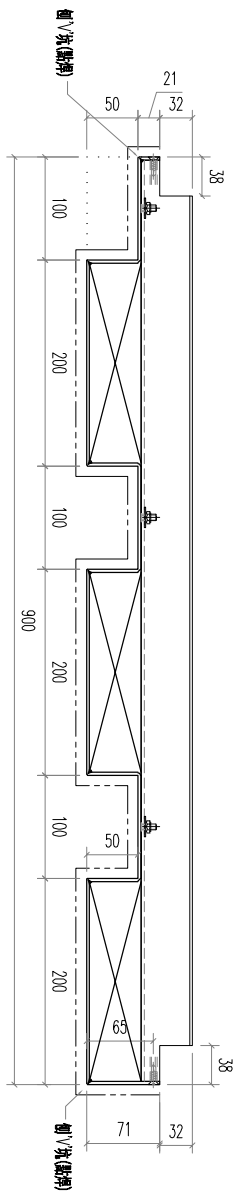

SECTION A1-A1

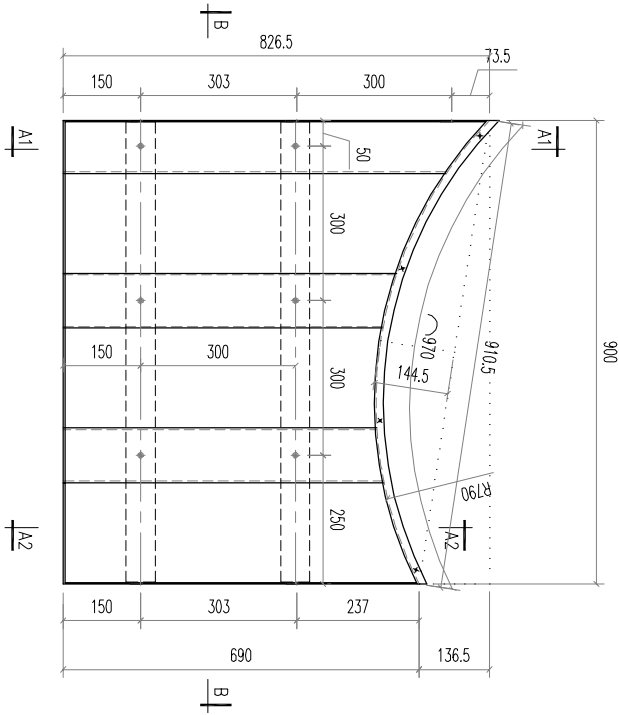

SECTION B-B

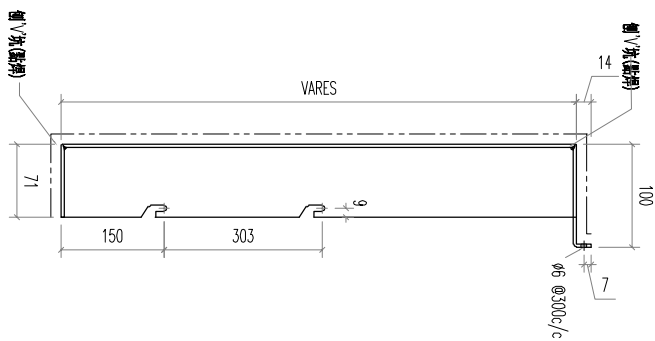

SECTION A2-A2

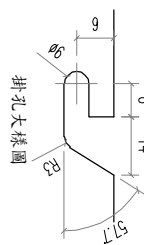

掛孔大樣圖

02	A1 鋁型材	893	開料	2	
REV	DATE	AMENDMENT	REVISED BY		

**美特鋁質有限公司**  
**MIDI ALUMINIUM FABRICATOR LTD.**  
 Units 6-8, Sunroy Industrial Centre, 1/F  
 610 Cha Kwo Ling Road, Kowloon  
 Tel: 23489211-4 Fax: (852) 27727666

PROJECT: J853-PODIUM ALUM CEILING  
 & FEATURE CLADDING T7 7/F

JOB NO. J853

FACTORY	W/CENTRE	CUT ENDS	FINISH
01	MARK/SCALE/FAB		EC-DG-0334232-201 (AL1)
Standard	X X . = ±1	Angle	DATE
Tolerances	X X . X = ±05	Squareness ±1°	4/19/2023

DRAWING TITLE	DRAWING NO.	POST PAINT	PART
鋁板天花加工圖 3mm THK. ALUM PLATE	T7-CE02-16-04	SCALE	TRACK TYPE
		1:5	S.....
			SHT. -/-
			REV. -

REV. CHECKED BY	PART NUMBER	Dim. A	Dim. B	Dim. C	Dim. D	Dim. E	Dim. F	Dim. G	QTY	Inv. Code	ASSEMBLE ON PARTS	EXTR. DRAWING PART DRAWING
-	T7-CE02-17-01								1			

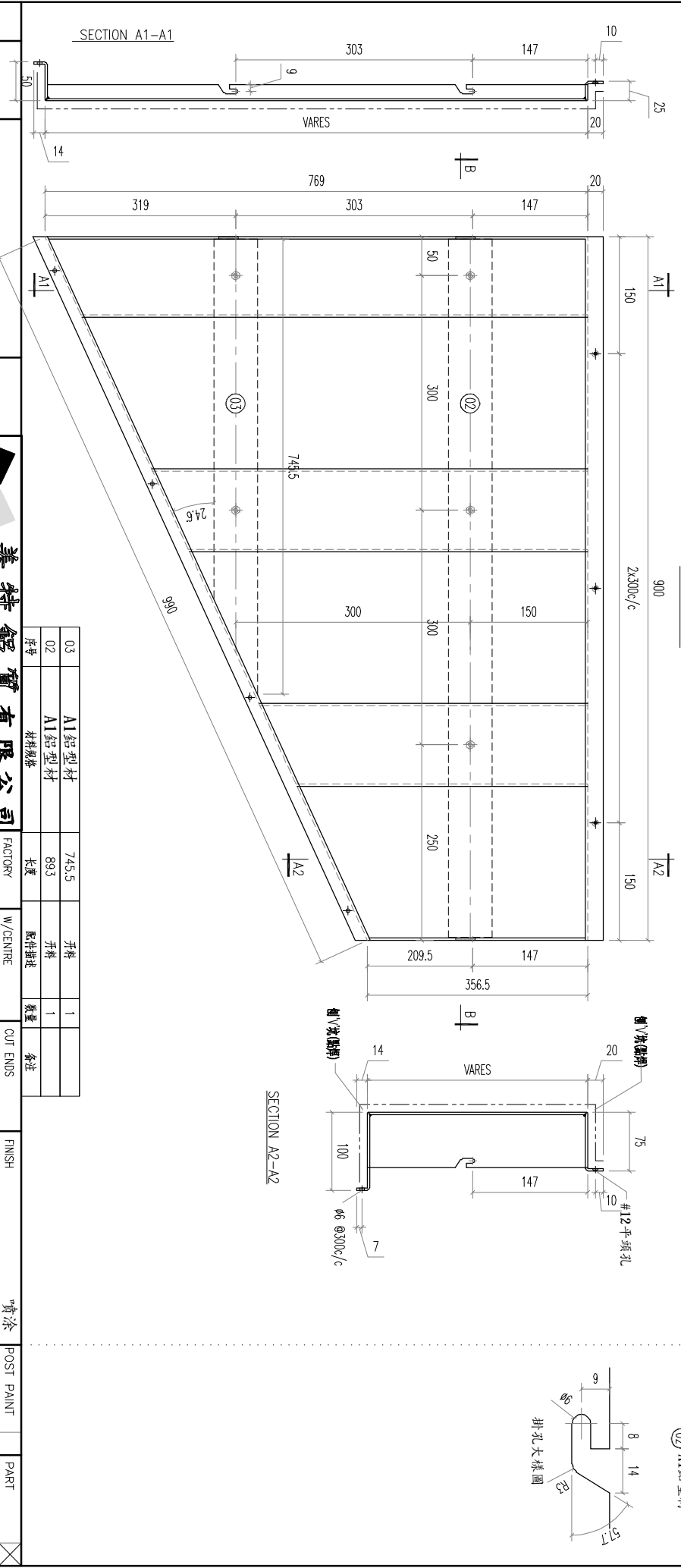
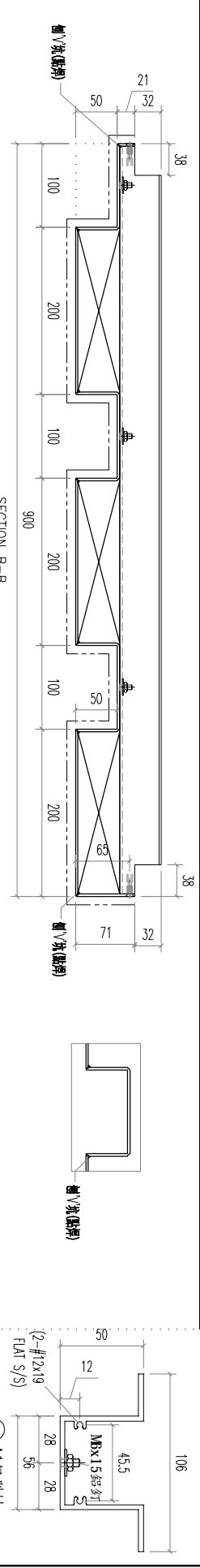

序號	材料規格	長度	材料	配件描述	數量	備註
03	A1鋁型材	745.5	材料		1	
02	A1鋁型材	893	材料		1	

**美特鋁質有限公司**  
MIDI ALUMINIUM FABRICATOR LTD.  
Units 6-8, Sunray Industrial Centre, 1/F  
610 Cho Kwo Ling Road, Kowloon  
Tel: 23489211-4 Fax: (852) 2727666

REV. DATE	AMENDMENT	REVISED BY	PROJECT	JOB NO.	DRAWING TITLE	DRAWING NO.	POST PAINT	PART	SHT.	REV.
			J853-PODIUM ALUM CEILING & FEATURE CLADDING T7 7/F	J853	鋁板天花加工圖 3mm THK. ALUM PLATE	T7-CE02-17-01	噴漆 PRE PAINT SCALE 1:5	噴漆 SUB ASSEM. TRACK TYPE S.....	-/-	-

REV.	CHECKED	PART NUMBER	Dim. A	Dim. B	Dim. C	Dim. D	Dim. E	Dim. F	Dim. G	QTY	Inv. Code	ASSEMBLE ON PARTS	EXTR. DRAWING
1	BAR BY	T7-CE02-17-02								1			PART DRAWING

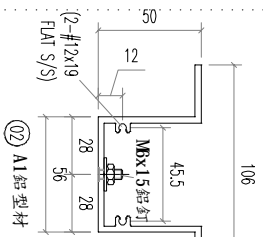
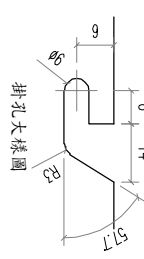
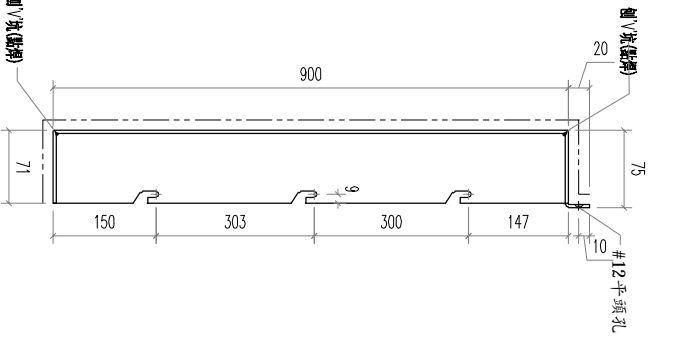
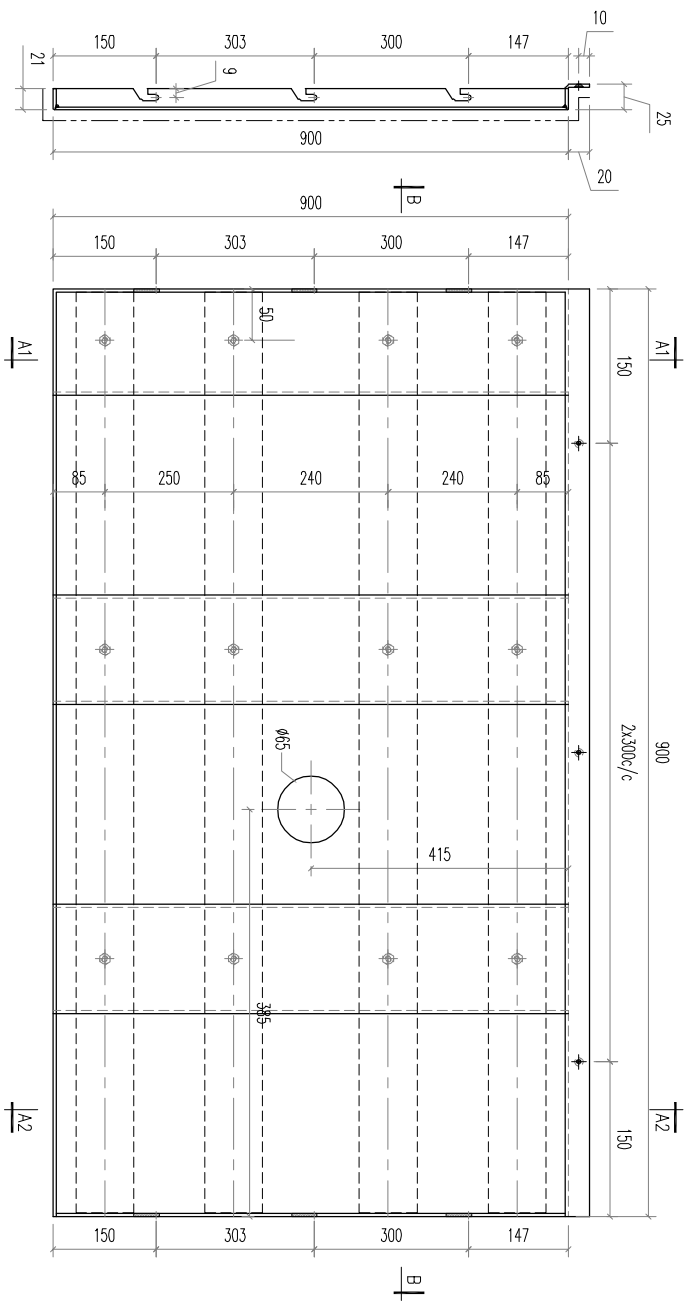
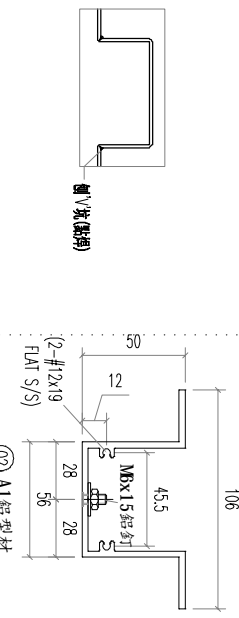
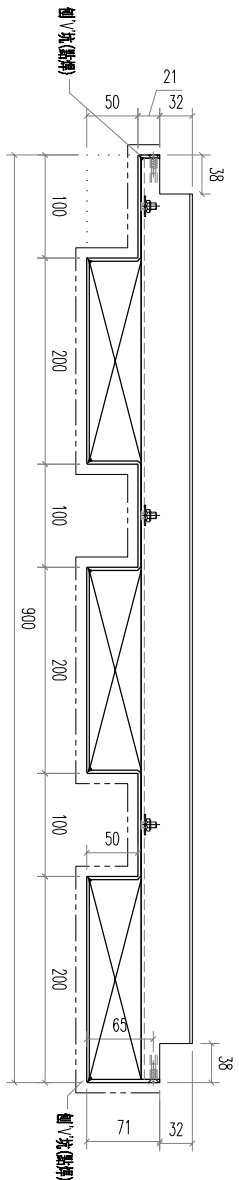

02	A1 鋁型材	893	開料	4	
REV.	DATE	AMENDMENT	REVISED BY		
<p>UNITED ALUMINIUM FABRICATOR LTD.</p> <p>美特鋁質有限公司</p> <p>Units 6-8, Sunroy Industrial Centre, 1/F 610 Cho Kwo Ling Road, Kowloon Tel: 23489211-4 Fax: (852) 2727666</p> <p>PROJECT J853-PODIUM ALUM CEILING &amp; FEATURE CLADDING T7 7/F</p> <p>JOB NO. J853</p> <p>FACTORY 01 W/CENTRE MBK/SDBA/FAB CUT ENDS DATE 4/19/2023 FINISH EC-DG-0334232-201 (AL1) 噴漆</p> <p>Standard X X . = ±1 Angle ±1° DATE 4/19/2023</p> <p>Tolerances X X . X = ±05 Squariness ±1°</p> <p>DRAWING TITLE 鋁板天花加工圖 3mm THK. ALUM PLATE</p> <p>DRAWING NO. T7-CE02-17-02</p> <p>POST PAINT PRE PAINT SCALE 1:5 PART SUB ASSEM. TRACK TYPE S.....</p> <p>SHT. -/- REV. -</p>					

REV.	CHECKED DATE BY	PART NUMBER	Dim. A	Dim. B	Dim. C	Dim. D	Dim. E	Dim. F	Dim. G	QTY	Inv. Code	ASSEMBLE ON PARTS	EXTR. DRAWING PART DRAWING
-		T7-CE02-17-03								1			

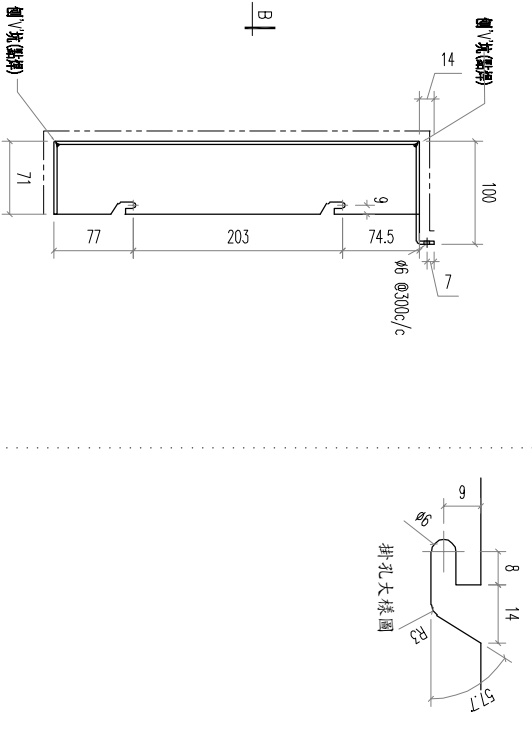
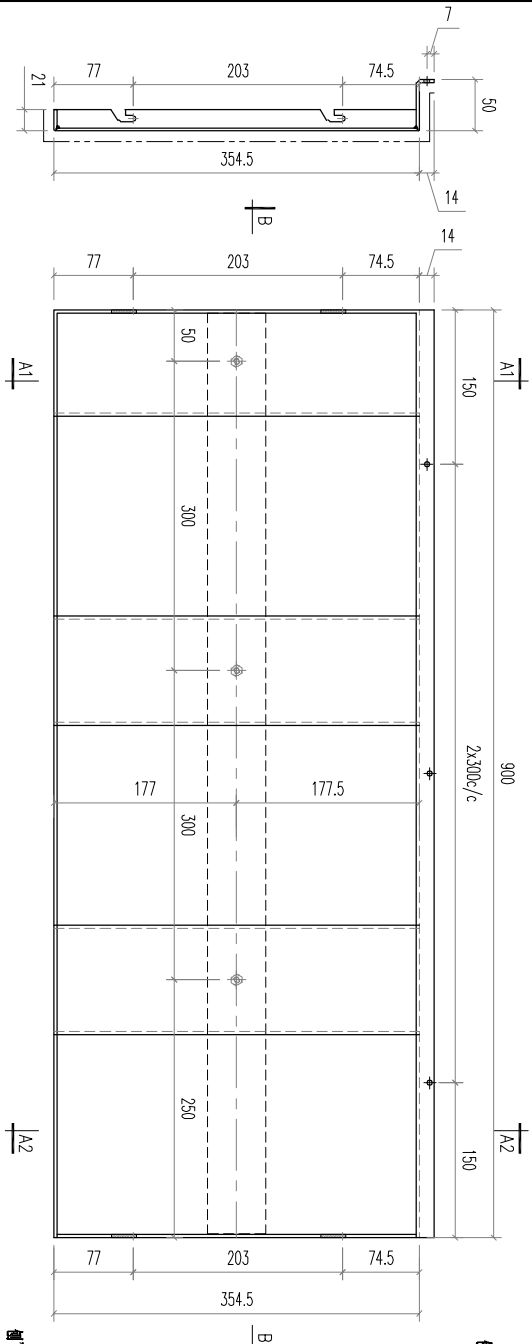
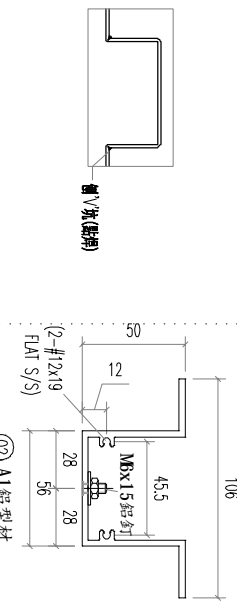
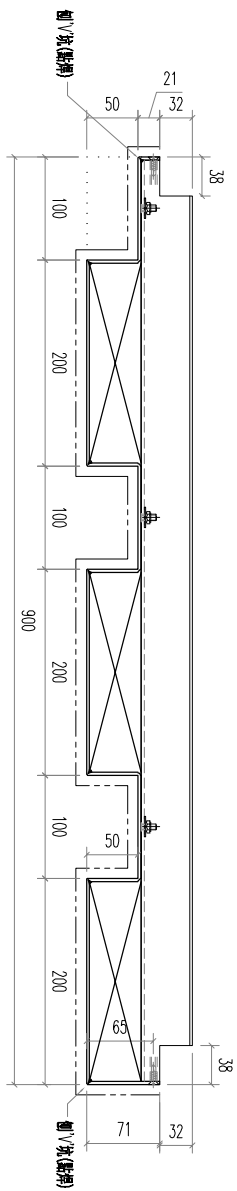

REV.	DATE	AMENDMENT	REVISED BY	REVISION	REVISION DESCRIPTION	QUANTITY	REMARKS
02		A1 鋁型材		893	材料規格	1	開料

  

<b>美特鋁質有限公司</b> <b>MIDI ALUMINIUM FABRICATOR LTD.</b> Units 6-8, Sunray Industrial Centre, 610 Cho Kwo Ling Road, Kowloon Tel:23489211-4 Fax:(852)27727666	PROJECT <b>J853-PODIUM ALUM CEILING</b> <b>&amp; FEATURE CLADDING T7 7/F</b>	JOB NO. <b>J853</b>	DRAWING TITLE <b>鋁板天花加工圖</b> <b>3mm THK. ALUM PLATE</b>	DRAWING NO. <b>T7-CE02-17-03</b>	SHT. <b>-/-</b>	REV. <b>-</b>
------------------------------------------------------------------------------------------------------------------------------------------------------------------------	------------------------------------------------------------------------------------	------------------------	---------------------------------------------------------------	-------------------------------------	--------------------	------------------

FACTORY <b>01</b>	W/CENTRE <b>MARK/SKID/FAB</b>	CUT ENDS <b>Angle</b>	FINISH <b>EC-D6-0334232-201 (AL1)</b>	DATE <b>4/19/2023</b>	DRAWN <b>YEUNG</b>	POST PAINT <b>SCALE</b>	PART <b>TRACK TYPE</b>
Standard X X . X ±1 X X . X ±05	X X . X ±1 X X . X ±05	Angle Squareness ±1°	EC-D6-0334232-201 (AL1)	4/19/2023	YEUNG	SCALE 1:5	TRACK TYPE S.....

REV.	CHECKED DATE BY	PART NUMBER	Dim. A	Dim. B	Dim. C	Dim. D	Dim. E	Dim. F	Dim. G	QTY	Inv. Code	ASSEMBLY ON PARTS	EXTR. DRAWING PART DRAWING
-		T7-CE02-18-01				951				1			

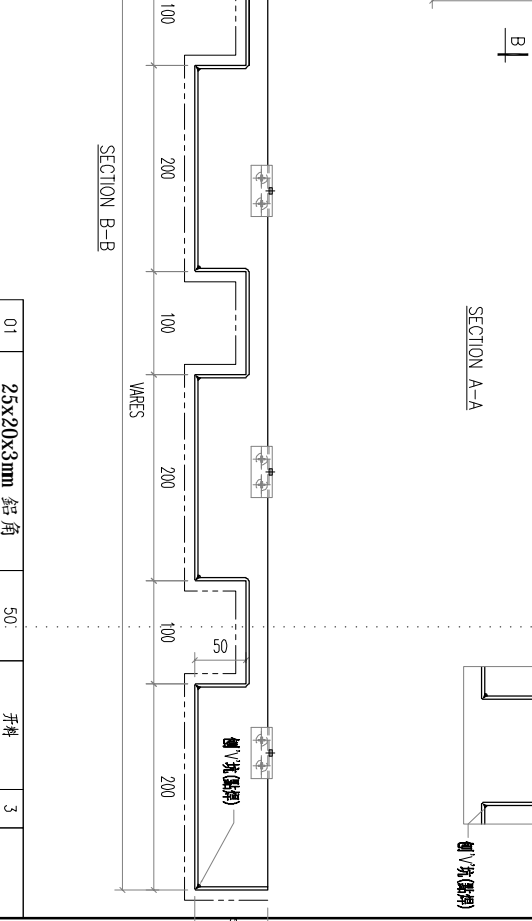
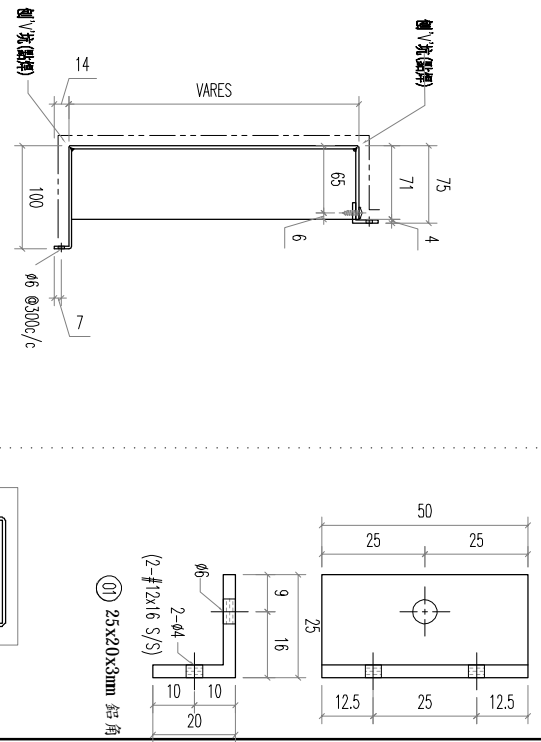
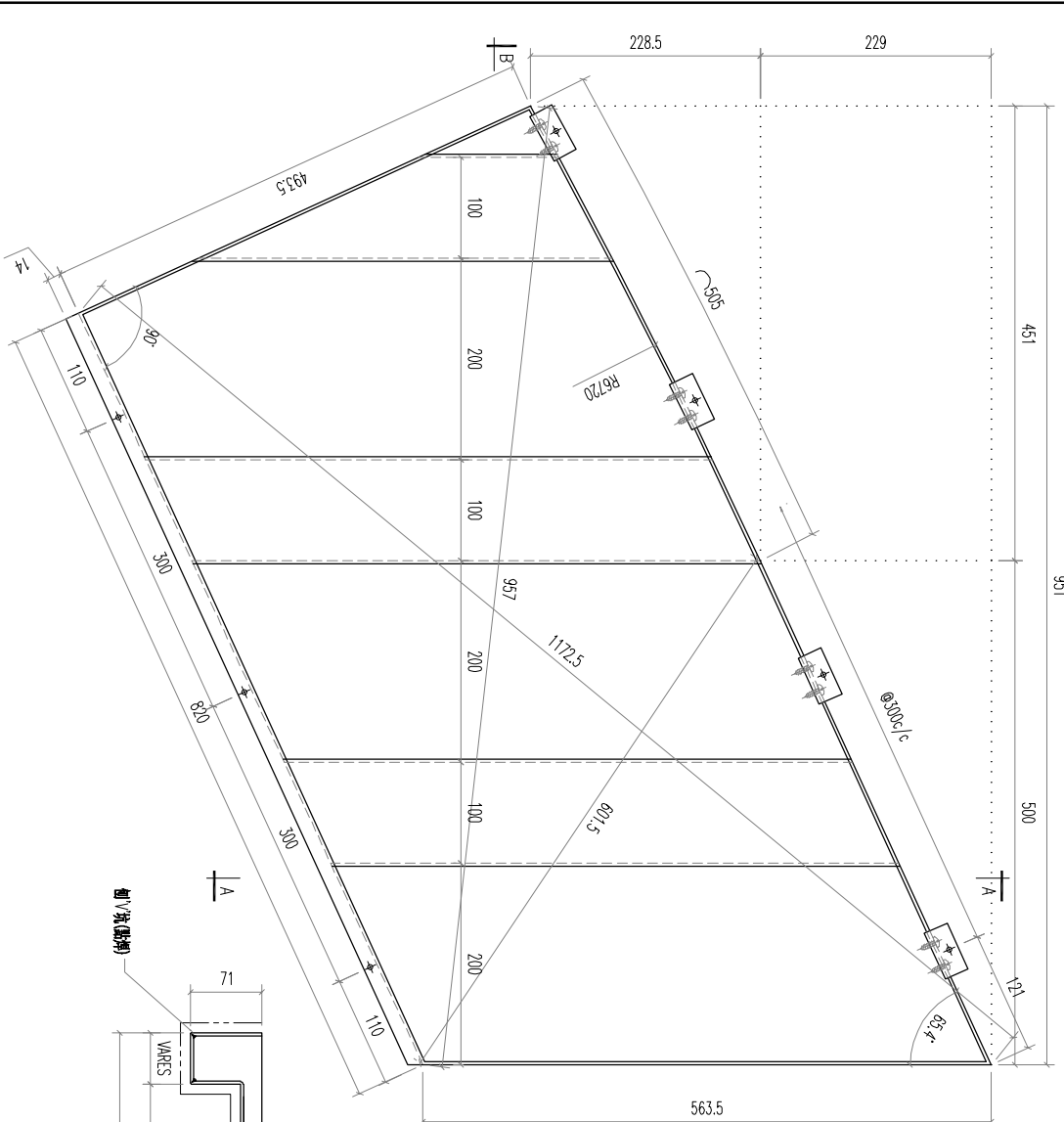

REV.		DATE		AMENDMENT		REVISED BY		<b>美特鋁質有限公司</b> MIDI ALUMINUM FABRICATOR LTD. Units 6-8, Sunray Industrial Centre, 1/F 610 Cha Kwo Ling Road, Kowloon Tel:23489211-4 Fax:(852)2727666		PROJECT		JOB NO.		DRAWING TITLE		DRAWING NO.	
										J853-PODIUM ALUM CEILING & FEATURE CLADDING T7 7/F		J853		鋁板天花加工圖 3mm THK. ALUM PLATE		T7-CE02-18-01	
FACTORY		W/CENTRE		CUT ENDS		FINISH		DATE		DRAWN		SCALE		SHT.		REV.	
01		25X20X3mm 鋁角		±1		EC-DG-0334232-201 (AL1)		4/19/2023		YEUNG		1:5		-/-		-	
TOLERANCES		X X . X = ±1		Angle		±1°											
TOLERANCES		X X . X = ±0.5		Squarness		±1°											
MATERIAL		鋁角		50'		開料		3		備注							
POST PAINT		PRE PAINT		SCALE		PART		SUB ASSEM.		TRACK TYPE		S.....					

REV.	CHECKED	PART NUMBER	Dim. A	Dim. B	Dim. C	Dim. D	Dim. E	Dim. F	Dim. G	QTY	Inv. Code	ASSEMBLE ON PARTS	EXTR. DRAWING
-	BAR BY	T7-CE02-18-02								1			PART DRAWING

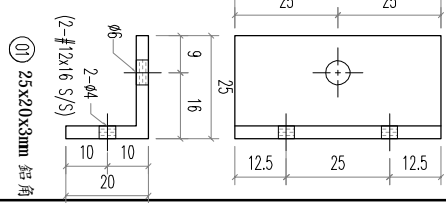
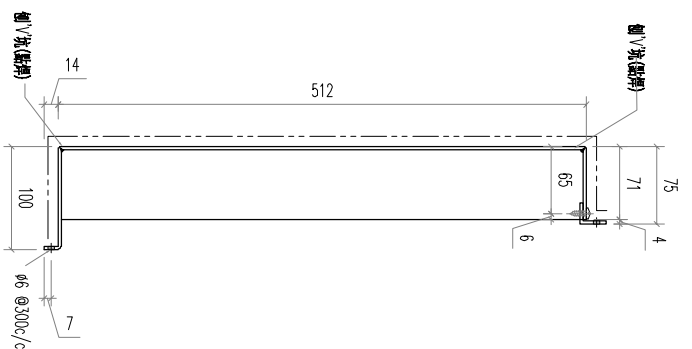
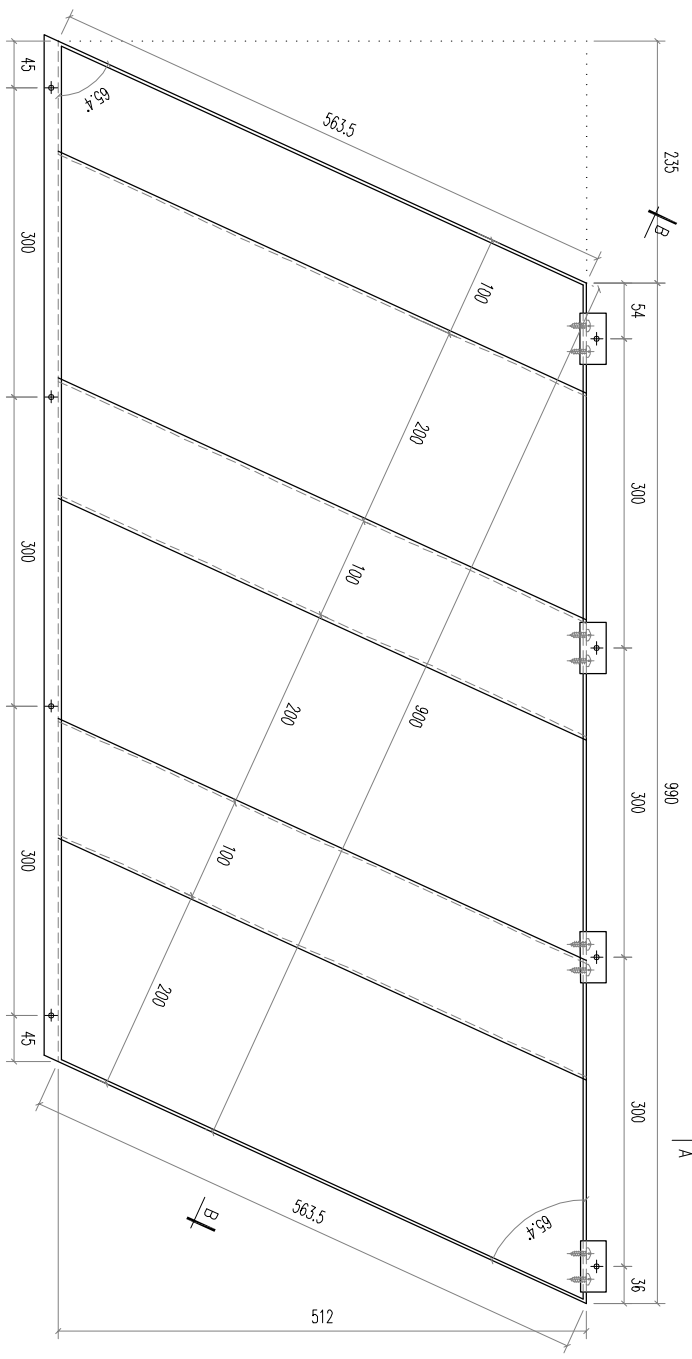
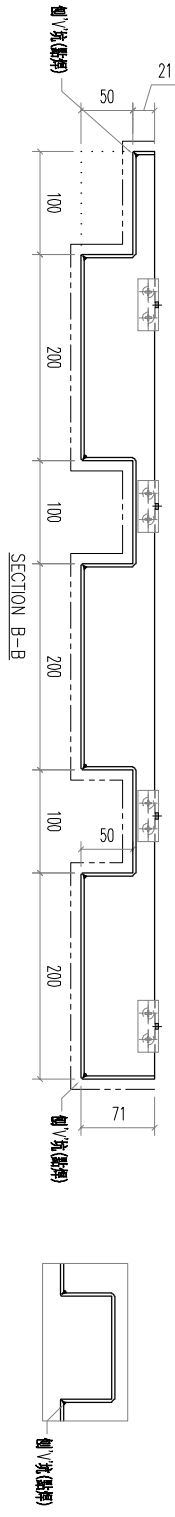

01	25x20x3mm 鋁角	50	開料	4	
序號	材料規格	長度	配件描述	數量	備註

FACTORY	W/CENTRE	CUT ENDS	FINISH	DATE	DRAWN	SCALE	SHT.	REV.
01	MAX/SKBA/FAB	Angle	EC-DG-0334232-201 (AL1)	4/19/2023	YEUNG	1:5	-/-	-
Standard	X X . X = ±1	Squareness ±1°	噴漆					
Tolerances	X X . X = ±05		PRE PAINT					

REV.	DATE	AMENDMENT	REVISED BY	PROJECT	JOB NO.	DRAWING TITLE	DRAWING NO.	SHT.	REV.
				J853-PODIUM ALUM CEILING & FEATURE CLADDING T7 7/F	J853	鋁板天花加工圖 3mm THK. ALUM PLATE	T7-CE02-18-02	-/-	-

**美特鋁質有限公司**  
MIDI ALUMINIUM FABRICATOR LTD.  
Units 6-8, Sunray Industrial Centre, 1/F  
610 Cha Kwo Ling Road, Kowloon  
Tel:23489211-4 Fax:(852)2727666

PROJECT J853-PODIUM ALUM CEILING & FEATURE CLADDING T7 7/F

JOB NO. J853

DRAWING TITLE 鋁板天花加工圖  
3mm THK. ALUM PLATE

DRAWING NO. T7-CE02-18-02

SHT. -/-  
REV. -

REV.	CHECKED	PART NUMBER	Dim. A	Dim. B	Dim. C	Dim. D	Dim. E	Dim. F	Dim. G	QTY	Inv. Code	ASSEMBLY ON PARTS	EXTR. DRAWING
—	BAR BY	T7-CE02-18-03								1			PART DRAWING

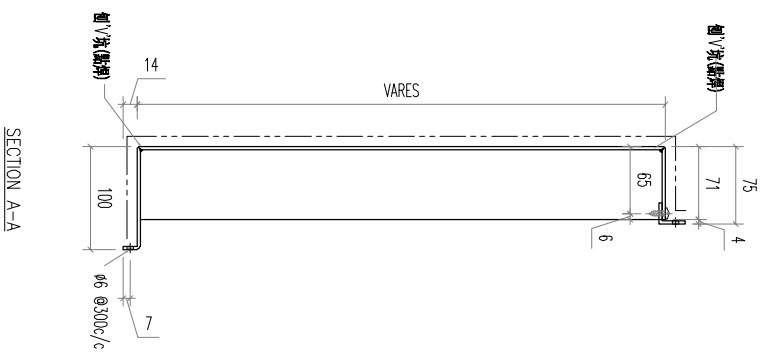
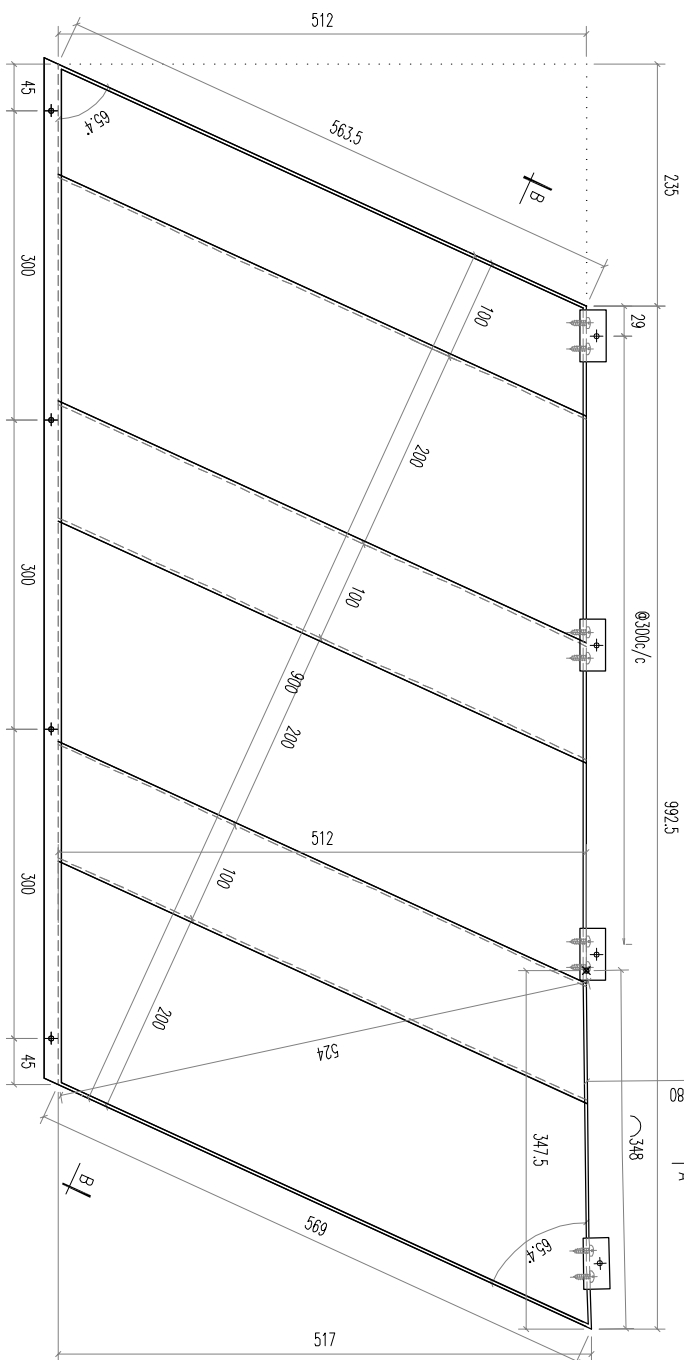
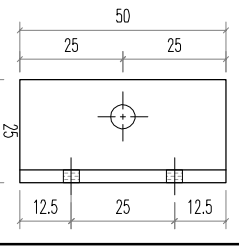
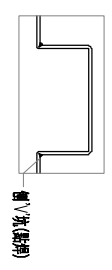
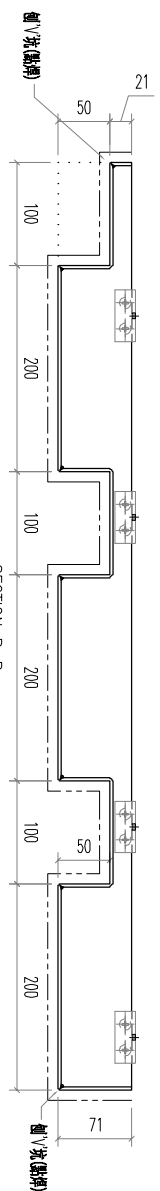

序号	长度	开料	数量	备注
01	50	配件描述	4	

**美特铝质有限公司**  
**MIDI ALUMINIUM FABRICATOR LTD.**  
 Units 6-8, Sunroy Industrial Centre, 1/F  
 610 Cho Kwo Ling Road, Kowloon  
 Tel:23489211-4 Fax:(852)2727666

REV.	DATE	AMENDMENT	REVISED BY

PROJECT	J853-PODIUM ALUM CEILING & FEATURE CLADDING T7 7/F	JOB NO.	J853
FACTORY	01	W/CENTRE	WORK/SKID/FAB
CUT ENDS	Standard	Angle	±1°
Tolerances	X X . X = ±1	Squareness	±1°
DATE	4/19/2023	DRAWN	YEUNG
DRAWING TITLE	铝板天花加工图 3mm THK. ALUM PLATE	DRAWING NO.	T7-CE02-18-03
SHT.	-/-	REV.	-

REV.	CHECKED	PART NUMBER	Dim. A	Dim. B	Dim. C	Dim. D	Dim. E	Dim. F	Dim. G	QTY	Inv. Code	ASSEMBLE ON PARTS	EXTR. DRAWING
1	BAR BY	T7-CE02-18-04								1			PART DRAWING

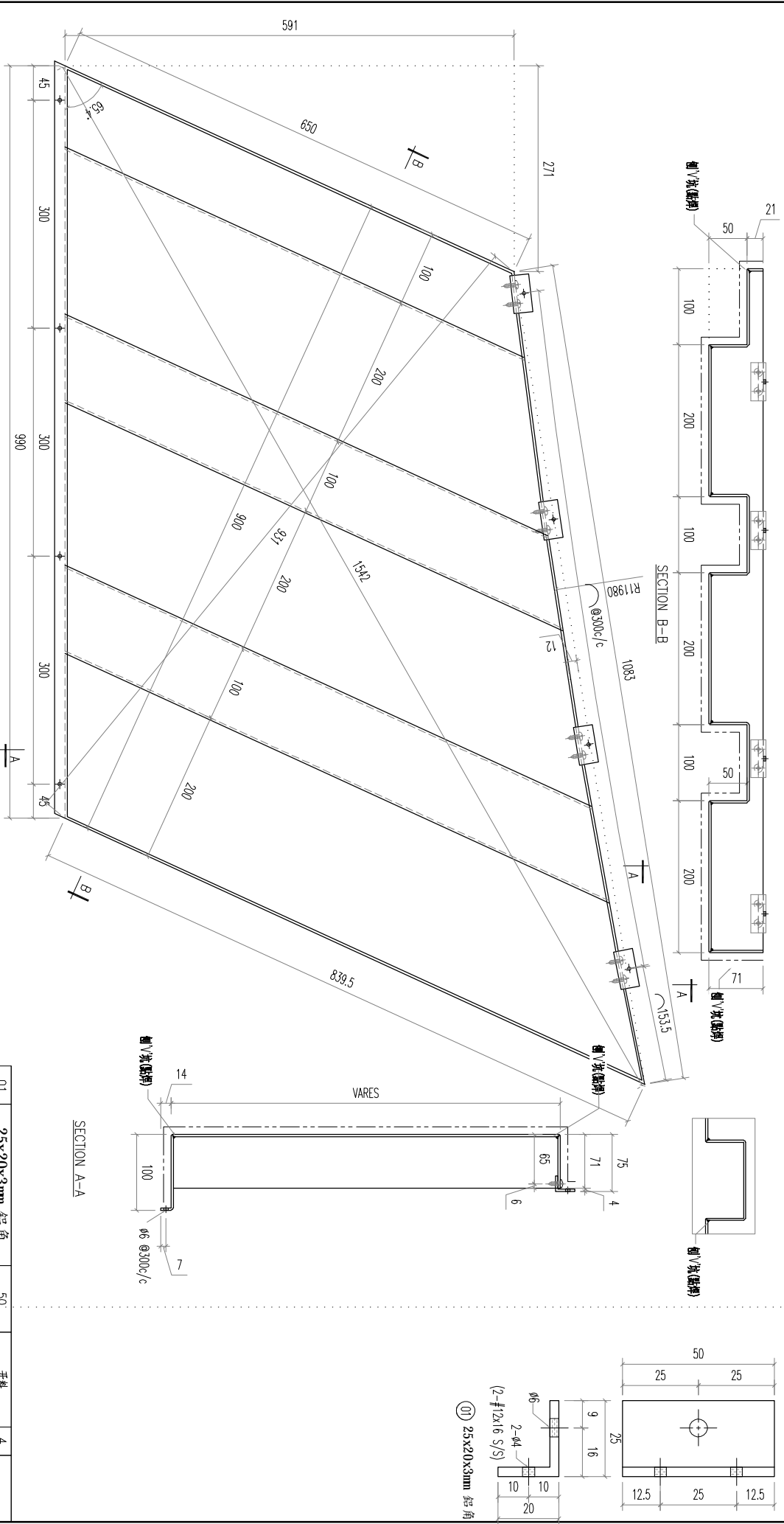

REV.	DATE	AMENDMENT	REVISED BY	PROJECT	JOB NO.	DRAWING TITLE	DRAWING NO.	SHT.	REV.
				J853-PODIUM ALUM CEILING & FEATURE CLADDING T7 7/F	J853	鋁板天花加工圖 3mm THK. ALUM PLATE	T7-CE02-18-04	-/-	-
				<b>美特鋁質有限公司</b> <b>MIDI ALUMINIUM FABRICATOR LTD.</b> Units 6-8, Sunroy Industrial Centre, 1/F 610 Cha Kwo Ling Road, Kowloon Tel:23489211-4 Fax:(852)2727666	FACTORY 01 W/CENTRE MARK/SCBA/FAB CUT ENDS Standard X X . X X . X = ±1 Tolerances X X . X = ±05 Angle Squareness ±1°	FINISH EC-DG-0334232-Z01 (AL1) DATE 4/19/2023 DRAWN YEUNG SCALE 1:5 TRACK TYPE S.....	01 25x20x3mm 鋁角 材料規格 50 開料 配件描述 數量 備註 4 		



REV.	CHECKED BAR BY	PART NUMBER	Dim. A	Dim. B	Dim. C	Dim. D	Dim. E	Dim. F	Dim. G	QTY	Inv. Code	ASSEMBLE ON PARTS	EXTR. DRAWING PART DRAWING
-		T7-CE02-19-01								1			

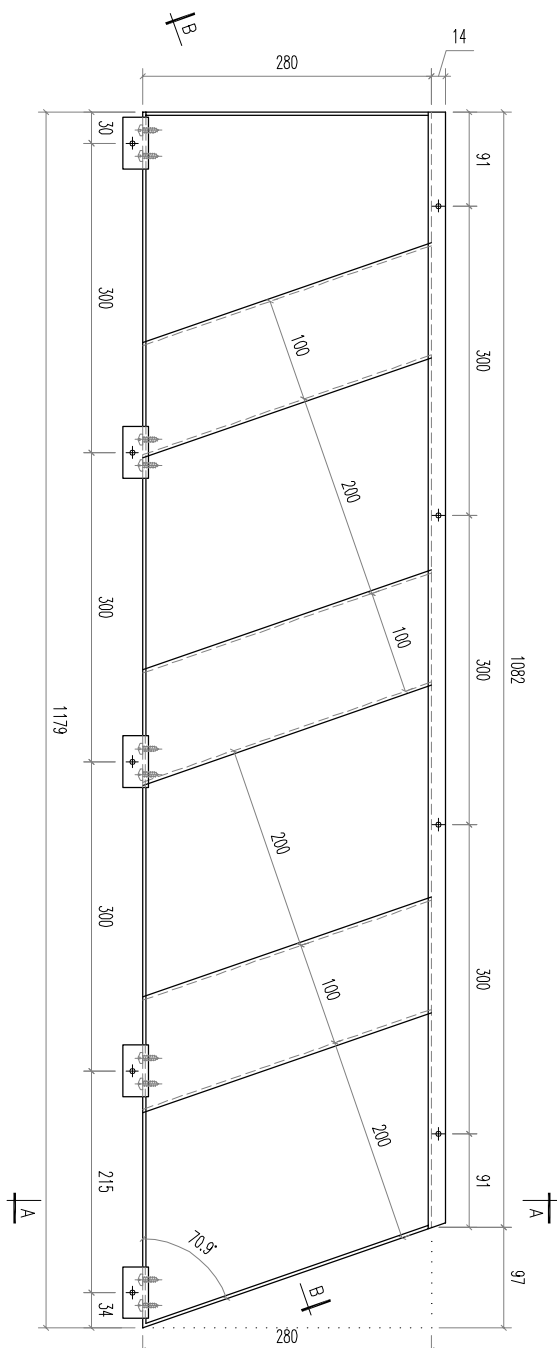
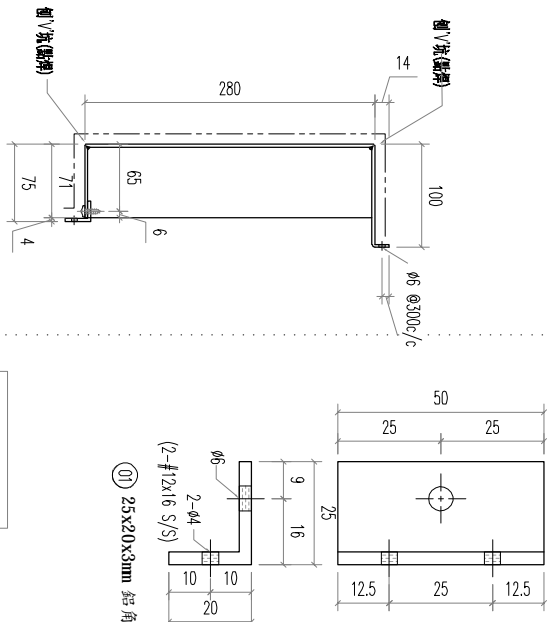
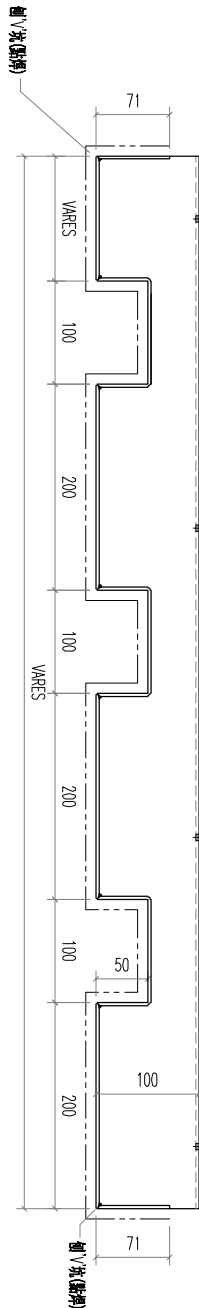

01	25x20x3mm 鋁角	50	開料	5	
序號	材料規格	長度	配件描述	數量	備註

**美特鋁質有限公司**  
MIDI ALUMINIUM FABRICATOR LTD.  
Units 6-8, Sunray Industrial Centre, 1/F  
610 Cho Kwo Ling Road, Kowloon  
Tel:23489211-4 Fax:(852)2727666

PROJECT J853-PODIUM ALUM CEILING  
& FEATURE CLADDING T7 7/F  
JOB NO. J853

FACTORY	W/CENTRE	CUT ENDS	FINISH	DATE	DRAWN	SCALE
01	MAX/SKBA/FAB	Angle	EC-DG-0334232-201 (AL1)	4/19/2023	YEUNG	1:5
Standard	X X . = ±1	Squareness ±1'				
Tolerances	X X . X = ±05					

DRAWING TITLE	DRAWING NO.	SHT.	REV.
鋁板天花加工圖 3mm THK. ALUM PLATE	T7-CE02-19-01	-/-	-

REV.	DATE	AMENDMENT	REVISED BY

REV.	CHECKED	PART NUMBER	Dim. A	Dim. B	Dim. C	Dim. D	Dim. E	Dim. F	Dim. G	QTY	Inv. Code	ASSEMBLE ON PARTS	EXTR. DRAWING
1	BAR BY	T7-CE02-19-02								1			PART DRAWING

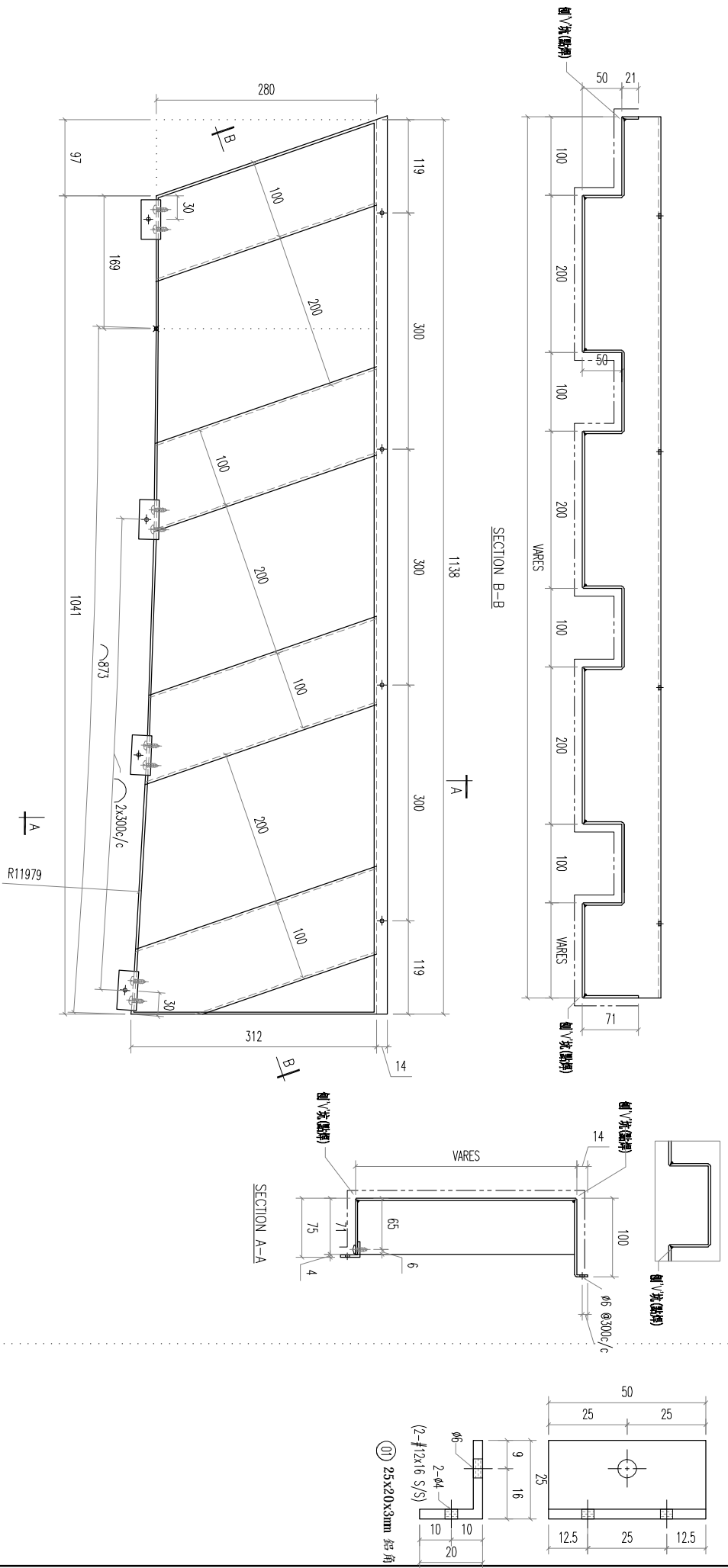

REV.	DATE	AMENDMENT	REVISED BY	PROJECT	JOB NO.	DRAWING TITLE	DRAWING NO.	SHT.	REV.
				J853-PODIUM ALUM CEILING & FEATURE CLADDING T7 7/F	J853	鋁板天花加工圖 3mm THK. ALUM PLATE	T7-CE02-19-02	-/-	-

**美特鋁質有限公司**  
MIDI ALUMINIUM FABRICATOR LTD.  
Units 6-8, Sunray Industrial Centre, 1/F  
610 Cho Kwo Ling Road, Kowloon  
Tel: 23489211-4 Fax: (852) 27727666

FACTORY 01  
W/CENTRE WCKB/SKBA/FAB  
CUT ENDS  
FINISH EC-DG-0334232-201 (AL1)  
DATE 4/19/2023  
DRAWN YEUNG  
SCALE 1:5

序号	材料规格	长度	开料	数量	备注
01	25x20x3mm 鋁角	50	配件描述	4	

REV.	CHECKED	PART NUMBER	Dim. A	Dim. B	Dim. C	Dim. D	Dim. E	Dim. F	Dim. G	QTY	Inv. Code	ASSEMBLE ON PARTS	EXTR. DRAWING
1	BAR BY	T7-CE02-19-03								1			PART DRAWING

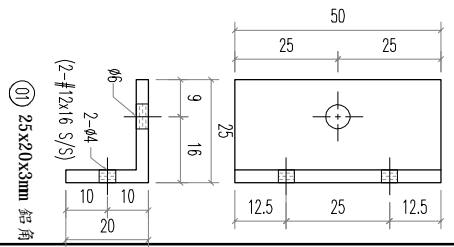
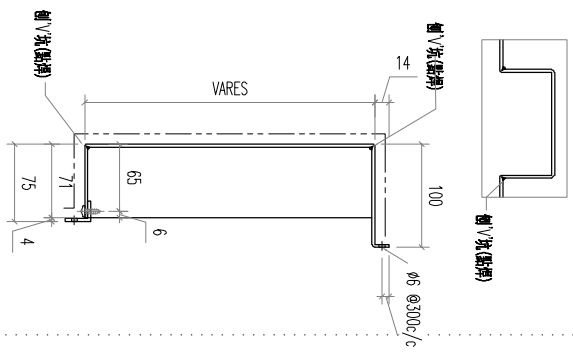
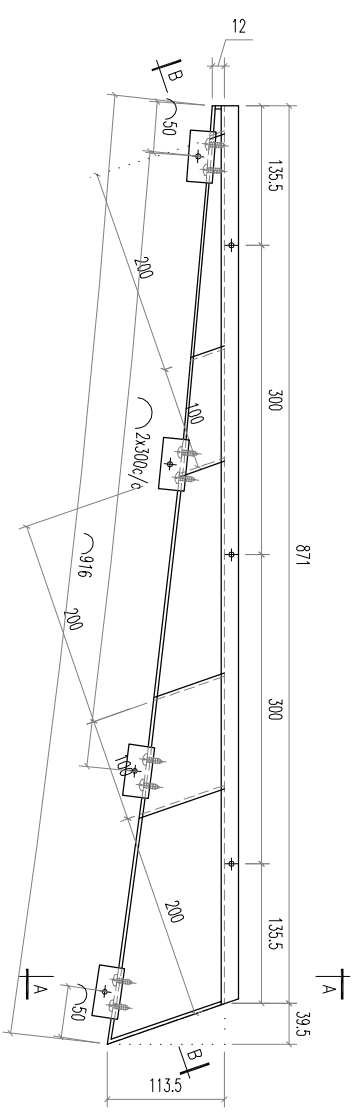
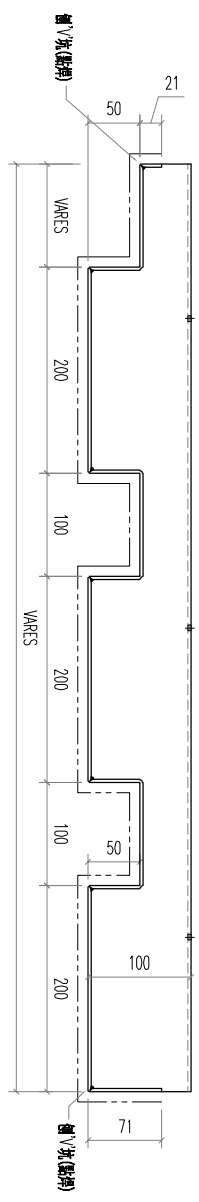

01	25x20x3mm 鋁角	50	開料	4	
序號	材料規格	長度	配件描述	數量	備註

**美特鋁質有限公司**  
**MIDI ALUMINIUM FABRICATOR LTD.**  
 Units 6-8, Sunroy Industrial Centre, 1/F  
 610 Cho Kwo Ling Road, Kowloon  
 Tel:23489211-4 Fax:(852)2727666

PROJECT **J853-PODIUM ALUM CEILING**  
 & FEATURE CLADDING T7 7/F  
 JOB NO. **J853**

FACTORY	W/CENTRE	CUT ENDS	FINISH	DATE	DRAWN	SCALE
01	MAX/SKID/FAB	Angle	EC-DG-0334232-201 (AL1)	4/19/2023	YEUNG	1:5

DRAWING TITLE  
**鋁板天花加工圖**  
**3mm THK. ALUM PLATE**

DRAWING NO.	T7-CE02-19-03	SHT.	1/-
REV.		REV.	

REV.	CHECKED	PART NUMBER	Dim. A	Dim. B	Dim. C	Dim. D	Dim. E	Dim. F	Dim. G	QTY	Inv. Code	ASSEMBLE ON PARTS	EXTR. DRAWING
1	BAR BY	T7-CE02-19-04								1			PART DRAWING

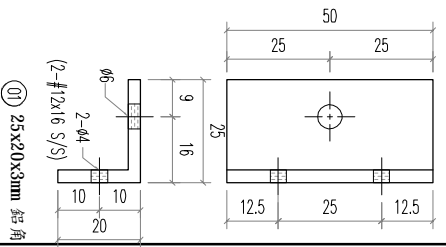
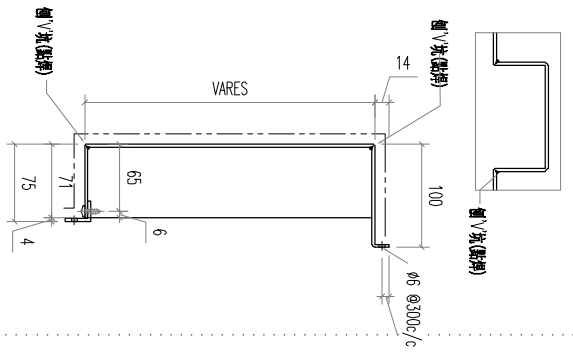
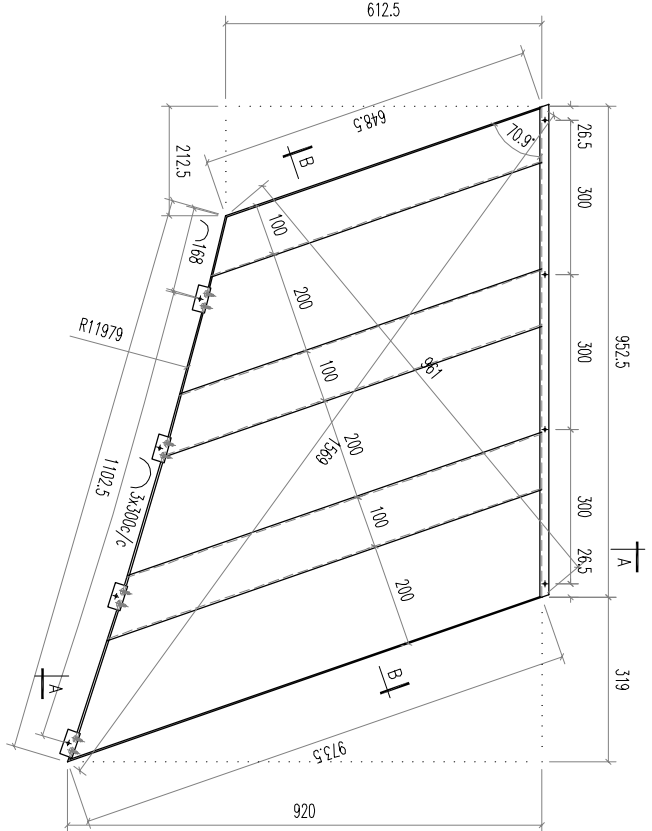
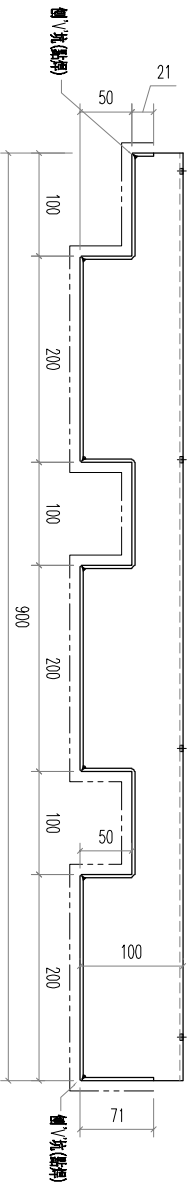

01	25x20x3mm 鋁角	50	開料	4	
序號	材料規格	長度	配件描述	數量	備註

**美特鋁質有限公司**  
**MIDI ALUMINIUM FABRICATOR LTD.**  
 Units 6-8, Sunroy Industrial Centre, 1/F  
 610 Cho Kwo Ling Road, Kowloon  
 Tel:23489211-4 Fax:(852)2727666

REV.	DATE	AMENDMENT	REVISED BY

PROJECT	J853-PODIUM ALUM CEILING & FEATURE CLADDING T7 7/F	JOB NO.	J853
FACTORY	01	W/CENTRE	MARK/SCALE/FAB
Standard	X X . = ±1	CUT ENDS	Angle
Tolerances	X X . X = ±05	Squareness	±1'
FINISH	EC-D6-0334232-201 (AL1)	DATE	4/19/2023
DRAWN	YEUNG	DRAWING NO.	T7-CE02-19-04
POST PAINT	PRE PAINT	SCALE	1:5
PART	SUB ASSEM.	TRACK TYPE	S.....
SHT.	-/-	REV.	-

REV.	CHECKED	PART NUMBER	Dim. A	Dim. B	Dim. C	Dim. D	Dim. E	Dim. F	Dim. G	QTY	Inv. Code	ASSEMBLE ON PARTS	EXTR. DRAWING
1	BAR BY	T7-CE02-19-05								1			PART DRAWING

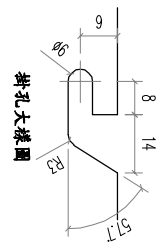
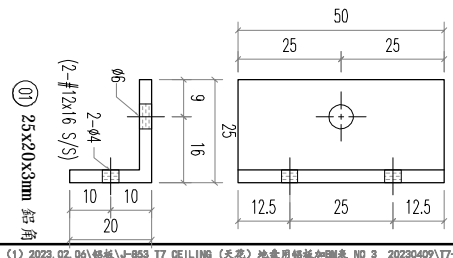
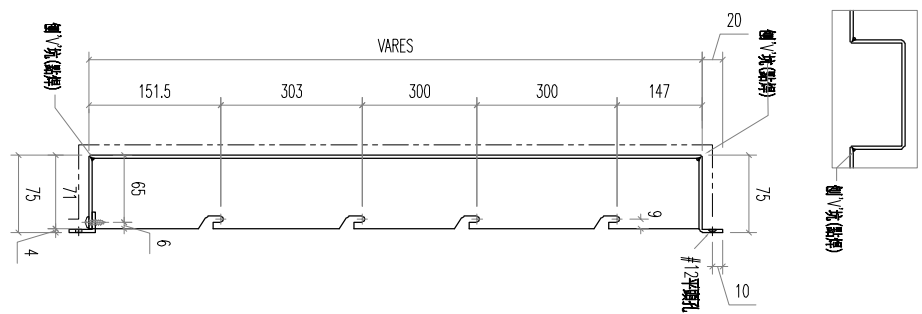
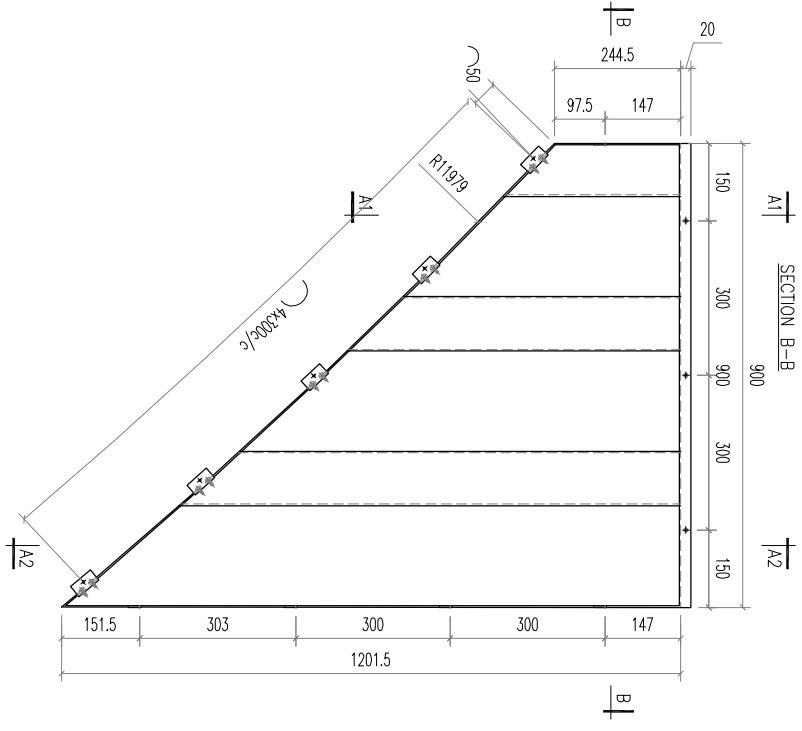
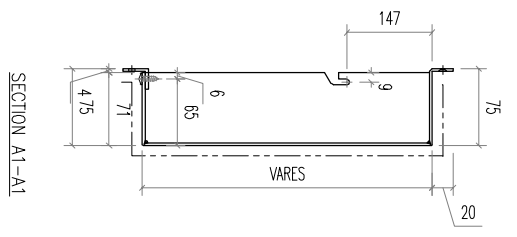
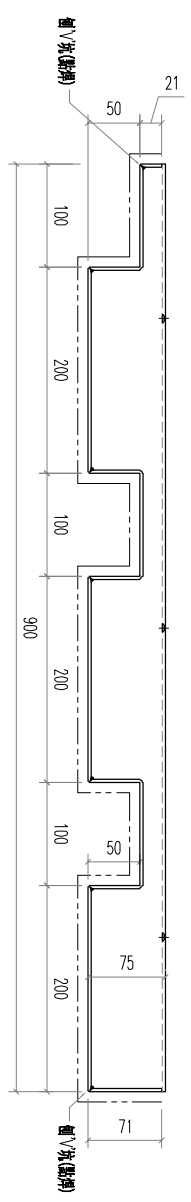

01	25x20x3mm 鋁角	50	5	
序號	材料規格	長度	開料	數量
			配件描述	備注

**美特鋁質有限公司**  
**MIDI ALUMINIUM FABRICATOR LTD.**  
 Units 6-8, Sunray Industrial Centre, 1/F  
 610 Cho Kwo Ling Road, Kowloon  
 Tel:23489211-4 Fax:(852)27727666

REV.	DATE	AMENDMENT	REVISED BY

PROJECT	J853-PODIUM ALUM CEILING & FEATURE CLADDING T7 7/F	JOB NO.	J853
DRAWING TITLE	鋁板天花加工圖 3mm THK. ALUM PLATE	DRAWING NO.	T7-CE02-19-05

FACTORY	01	W/CENTRE	MOK/SKBA/FAB	CUT ENDS	Angle Squareness ±1°	FINISH	EC-DG-0334232-201 (AL1)	DRAWN	YEUNG	SCALE	1:5	SHT.	-/-	
Standard	X X .	= ±1	Angle	±1°	DATE	4/19/2023	POST PAINT	PRE PAINT	PART	SUB ASSEM.	TRACK TYPE	S....	REV.	-

REV.	CHECKED	PART NUMBER	Dim. A	Dim. B	Dim. C	Dim. D	Dim. E	Dim. F	Dim. G	QTY	Inv. Code	ASSEMBLE ON PARTS	EXTR. DRAWING
1	BAR BY	T7-CE02-19-06								1			PART DRAWING

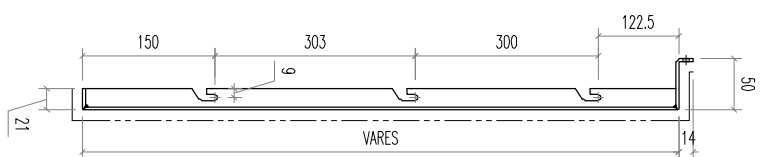
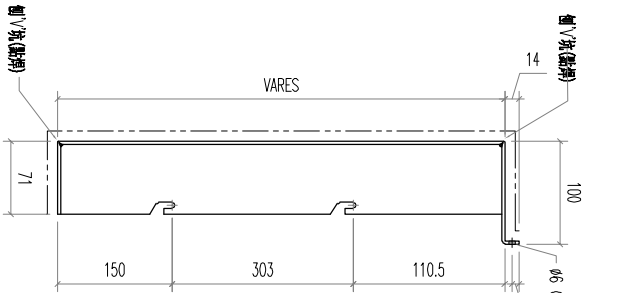
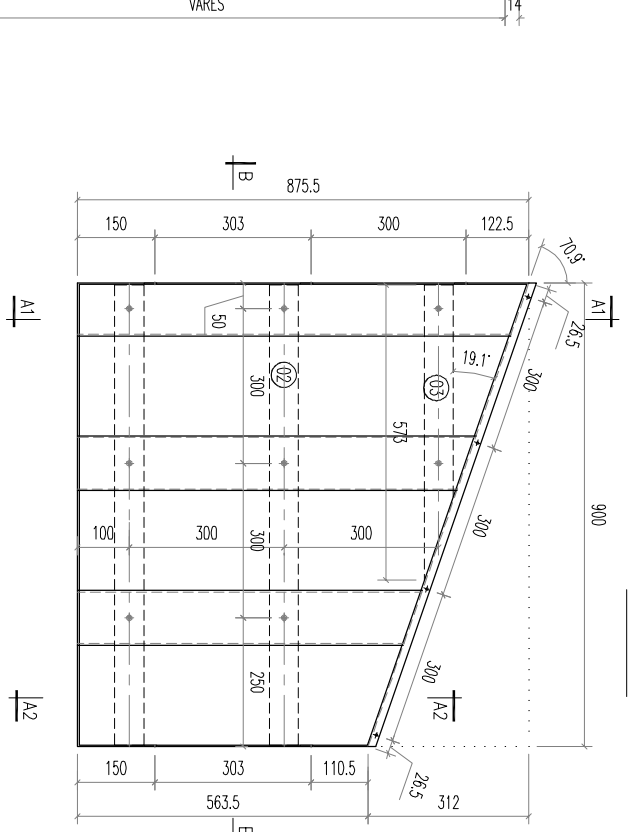
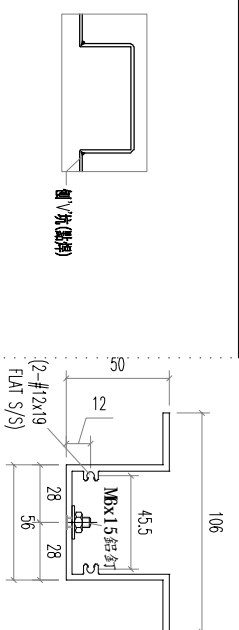
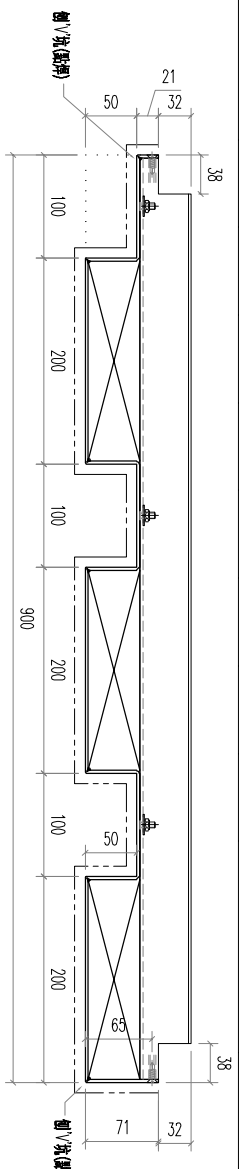

SECTION A1-A1

SECTION A2-A2

03	A1 鋁型材	575	1	
02	A1 鋁型材	893	2	
序號	材料規格	長度	配件描述	數量
				備註

**美特鋁質有限公司**  
MIDI ALUMINIUM FABRICATOR LTD.

Units 6-8, Sunroy Industrial Centre, 1/F  
610 Cha Kwo Ling Road, Kowloon  
Tel: 23489211-4 Fax: (852) 27727666

PROJECT J853-PODIUM ALUM CEILING  
& FEATURE CLADDING T7 7/F

REV.	DATE	AMENDMENT	REVISED BY

FACTORY	W/CENTRE	CUT ENDS	FINISH	DRAWING NO.
01	W/CKD/SKID/FAB		EC-DG-0334232-201 (A1)	T7-CE02-19-06
Standard	X X . = ±1	Angle	DATE	DRAWN
Tolerances	X X . X = ±05	Squareness ±1°	4/19/2023	YEUNG
DRAWING TITLE		3mm THK. ALUM PLATE		
JOB NO.	J853	SHT. REV.		