



工程指示 / 要求簡箋(E.I.)

工程指示編號：EI/4660/22

修改版次：

工程編號：J-853

工程名稱：大窩坪(廷坪路)

工程項目：幕埗單元件 T1, T2, T3, T6, T7 座 起步水槽料

收件人：生統

發件人：大明

日期：06/05/2022

要求提供 / 確認 事項：

- | | | |
|------------------------------------|-------------------------------------|-------------------------------|
| <input type="checkbox"/> 初步鋁料 B.M. | <input type="checkbox"/> 加工拆圖，然後生產 | <input type="checkbox"/> 尺寸表 |
| <input type="checkbox"/> 正式鋁料 B.M. | <input type="checkbox"/> 技術上資料 / 指示 | <input type="checkbox"/> 報 |
| <input type="checkbox"/> 配件 B.M. | <input type="checkbox"/> 樣辦或貨品說明書 | <input type="checkbox"/> 分判合約 |
| <input type="checkbox"/> 其他：_____ | | |

內容：

煩請依附件資料加工生產 各座幕埗單元件水槽起步料 後送地盤安裝
(分座顏色)

請在 30/06/2022 前完成上列要求。

附有關圖紙 / 文件：附 B.M 表 0 頁,圖紙 127 頁

以上項目為:

- 原合約工程包 原合約工程加 / 減賬 新工程報價

原因：-

分發東莞各部門：

- ()生產技術總監 連附件 ()技術部 連附件 ()生產部 連附件 ()機械設計部 連附件
 ()採購部 連附件 (✓)生產統籌部 連附件 梅. TRACY
 ()質檢部 連附件 ()會計部 連附件 ()報關組 連附件 (✓)其他 謝子培 連附件

分發香港各部門：

- ()行政部 連附件 ()會計部 連附件 ()統籌部 連附件 (✓)工程部地盤科文 連附件 先勇
 ()採購部 連附件 ()QS 部 連附件 ()維修部 連附件 ()其他 _____ 連附件

傳遞編號：

HK 0747

發件人簽署：

(Handwritten signature)

項目經理簽署：

(Handwritten signature: FTP)

圖則登記表
DRAWING REGISTER

工程名稱 Project Title:		九龍延坪道		接收日期 Receiving Date (適用於客戶圖則)							
T1座,T2座,T3座,T6座,T7座)水槽料 (加工圖/位置圖)				年							
工程編號 Project No:		J-853		月							
分發予 Distributed To				日							
				年	22						
				月	3						
				日	25						
圖則編號 Drg. No.	圖則名稱 Drawing Title	No.	修訂編號 Revision No.								
CW-GL01	封口片拆圖	1	-								
CW-GL02	封口墊片拆圖	2	-								
J853-T1-CW-S01	水槽料拆圖	3	-								
J853-T1-CW-S02a	水槽料拆圖	4	-								
J853-T1-CW-S02b	水槽料拆圖	5	-								
J853-T1-CW-S03	水槽料拆圖	6	-								
J853-T1-CW-S04	水槽料拆圖	7	-								
J853-T1-CW-S05	水槽料拆圖	8	-								
J853-T1-CW-S06	水槽料拆圖	9	-								
J853-T1-CW-S07	水槽料拆圖	10	-								
J853-T1-CW-S08	水槽料拆圖	11	-								
J853-T1-CW-S09	水槽料拆圖	12	-								
J853-T1-CW-S10	水槽料拆圖	13	-								
J853-T1-CW-S11	水槽料拆圖	14	-								
J853-T1-CW-S12a	水槽料拆圖	15	-								
J853-T1-CW-S12b	水槽料拆圖	16	-								
J853-T1-CW-S13	水槽料拆圖	17	-								
J853-T1-CW-S14	水槽料拆圖	18	-								
J853-T1-CW-S15	水槽料拆圖	19	-								
J853-T1-CW-S16	水槽料拆圖	20	-								
J853-T1-CW-KG01	玻璃扣蓋拆圖	21	-								
J853-T1-CW-KG01BM	玻璃扣蓋數據表	22	-								

圖則登記表
DRAWING REGISTER

工程名稱 Project Title:		九龍延坪道		接收日期 Receiving Date (適用於客戶圖則)							
T1座,T2座,T3座,T6座,T7座)水槽料 (加工圖/位置圖)				年							
工程編號 Project No:		J-853		月							
分發予 Distributed To				日							
				年	22						
				月	3						
				日	25						
圖則編號 Drg. No.	圖則名稱 Drawing Title			修訂編號 Revision No.							
J853-T1-CW-KG07	玻璃扣蓋拆圖			23	-						
J853-T1-CW-KG08	玻璃扣蓋拆圖			24	-						
J853-SD-CW-4101	水槽料/扣蓋位置圖			25	-						
J853-SD-CW-4102	水槽料/扣蓋位置圖			26	-						
J853-SD-CW-4103	水槽料/扣蓋位置圖			27	-						
J853-SD-CW-4104	水槽料/扣蓋位置圖			28	-						
J853-SD-CW-4106	水槽料/扣蓋位置圖			29	-						
J853-T2-CW-S01	水槽料拆圖			30	-						
J853-T2-CW-S02	水槽料拆圖			31	-						
J853-T2-CW-S03	水槽料拆圖			32	-						
J853-T2-CW-S04a	水槽料拆圖			33	-						
J853-T2-CW-S04b	水槽料拆圖			34	-						
J853-T2-CW-S05	水槽料拆圖			35	-						
J853-T2-CW-S06	水槽料拆圖			36	-						
J853-T2-CW-S07	水槽料拆圖			37	-						
J853-T2-CW-S08	水槽料拆圖			38	-						
J853-T2-CW-S09	水槽料拆圖			39	-						
J853-T2-CW-S10	水槽料拆圖			40	-						
J853-T2-CW-S11	水槽料拆圖			41	-						
J853-T2-CW-S12a	水槽料拆圖			42	-						
J853-T2-CW-S12b	水槽料拆圖			43	-						
J853-T2-CW-S13a	水槽料拆圖			44	-						

圖則登記表
DRAWING REGISTER

接收日期 Receiving Date (適用於客戶圖則)		年									
工程名稱 Project Title:	九龍延坪道	月									
T1座,T2座,T3座,T6座,T7座)水槽料 (加工圖/位置圖)		日									
工程編號 Project No:	J-853										
分發予 Distributed To											
		年	22								
		月	3								
		日	25								
圖則編號 Drg. No.	圖則名稱 Drawing Title		修訂編號 Revision No.								
J853-T2-CW-S13b	水槽料拆圖	45	-								
J853-T2-CW-KG01	玻璃扣蓋拆圖	46	-								
J853-T2-CW-KG01BM	玻璃扣蓋數據表	47	-								
J853-T2-CW-KG06	玻璃扣蓋拆圖	48	-								
J853-T2-CW-KG07	玻璃扣蓋拆圖	49	-								
J853-SD-CW-4201	水槽料/扣蓋位置圖	50	-								
J853-SD-CW-4202	水槽料/扣蓋位置圖	51	-								
J853-SD-CW-4203	水槽料/扣蓋位置圖	52	-								
J853-SD-CW-4204	水槽料/扣蓋位置圖	53	-								
J853-SD-CW-4204A	水槽料/扣蓋位置圖	54	-								
J853-SD-CW-4205	水槽料/扣蓋位置圖	55	-								
J853-SD-CW-4206	水槽料/扣蓋位置圖	56	-								
J853-T3-CW-S01	水槽料拆圖	57	-								
J853-T3-CW-S02	水槽料拆圖	58	-								
J853-T3-CW-S03	水槽料拆圖	59	-								
J853-T3-CW-S04	水槽料拆圖	60	-								
J853-T3-CW-S05	水槽料拆圖	61	-								
J853-T3-CW-S06	水槽料拆圖	62	-								
J853-T3-CW-S07a	水槽料拆圖	63	-								
J853-T3-CW-S07b	水槽料拆圖	64	-								
J853-T3-CW-S08	水槽料拆圖	65	-								
J853-T3-CW-S09a	水槽料拆圖	66	-								

圖則登記表
DRAWING REGISTER

圖則編號 Drg. No.		圖則名稱 Drawing Title		年 月 日	接收日期 Receiving Date (適用於客戶圖則)										
工程名稱 Project Title:		九龍延坪道			年 月 日										
T1座,T2座,T3座,T6座,T7座)水槽料 (加工圖/位置圖)															
工程編號 Project No:		J-853													
分發予 Distributed To				年 月 日											
					22										
					3										
				25											
圖則編號 Drg. No.		圖則名稱 Drawing Title		年 月 日	修訂編號 Revision No.										
J853-T6-CW-S04a		水槽料拆圖			89	-									
J853-T6-CW-S04b		水槽料拆圖		90	-										
J853-T6-CW-S05a		水槽料拆圖		91	-										
J853-T6-CW-S05b		水槽料拆圖		92	-										
J853-T6-CW-S06		水槽料拆圖		93	-										
J853-T6-CW-S07a		水槽料拆圖		94	-										
J853-T6-CW-S07b		水槽料拆圖		95	-										
J853-T6-CW-S08		水槽料拆圖		96	-										
J853-T6-CW-S09		水槽料拆圖		97	-										
J853-T6-CW-KG01		玻璃扣蓋拆圖		98	-										
J853-T6-CW-KG01BM		玻璃扣蓋數據表		99	-										
J853-SD-CW-4601		水槽料/扣蓋位置圖		100	-										
J853-SD-CW-4602		水槽料/扣蓋位置圖		101	-										
J853-SD-CW-4602A		水槽料/扣蓋位置圖		102	-										
J853-SD-CW-4606		水槽料/扣蓋位置圖		103	-										
J853-SD-CW-4607		水槽料/扣蓋位置圖		104	-										
J853-T7-CW-S01		水槽料拆圖		105	-										
J853-T7-CW-S02a		水槽料拆圖		106	-										
J853-T7-CW-S02b		水槽料拆圖		107	-										
J853-T7-CW-S03		水槽料拆圖		108	-										
J853-T7-CW-S04a		水槽料拆圖		109	-										
J853-T7-CW-S04b		水槽料拆圖		110	-										

圖則登記表
DRAWING REGISTER

接收日期 Receiving Date (適用於客戶圖則)			
工程名稱 Project Title:	九龍延坪道	年	
T1座,T2座,T3座,T6座,T7座)水槽料 (加工圖/位置圖)		月	
工程編號 Project No:	J-853	日	
分發予 Distributed To			
		年	22
		月	3
		日	25
圖則編號 Drg. No.	圖則名稱 Drawing Title		修訂編號 Revision No.
J853-T7-CW-S05	水槽料拆圖	111	-
J853-T7-CW-S06	水槽料拆圖	112	-
J853-T7-CW-S07	水槽料拆圖	113	-
J853-T7-CW-KG01	玻璃扣蓋拆圖	114	-
J853-T7-CW-KG01BM	玻璃扣蓋數據表	115	-
J853-T7-CW-KG05	玻璃扣蓋拆圖	116	-
J853-T7-CW-KG06	玻璃扣蓋拆圖	117	-
J853-SD-CW-4603	水槽料/扣蓋位置圖	118	-
J853-SD-CW-4604	水槽料/扣蓋位置圖	119	-
J853-SD-CW-4605	水槽料/扣蓋位置圖	120	-
J853-SD-CW-4608	水槽料/扣蓋位置圖	121	-

美特鋁質有限公司
MIDI Aluminium Fabricator Ltd.

工程號 J853 地盤 延坪道

物料編號	使用位置	數量
CW-GL01	T1	28
	T2	25
	T3	25
	T6	20
	T7	15

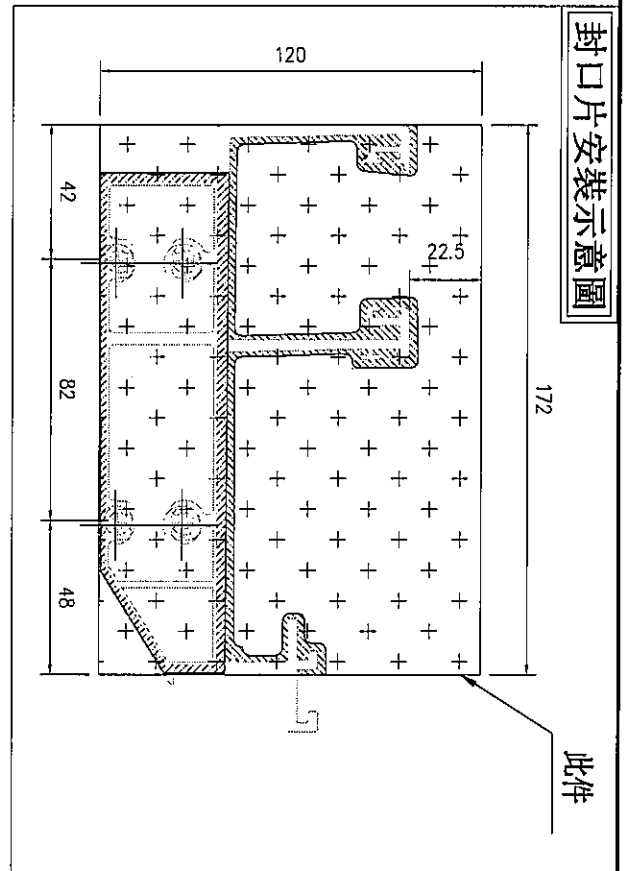
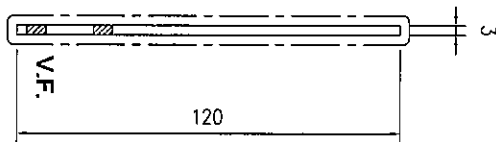
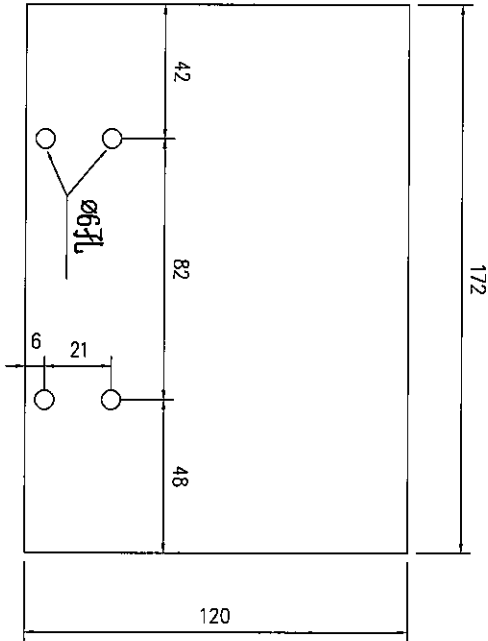

封口片安裝示意圖

此件

名稱	封口片	制圖	陳敏聰	2022.03.05	修改		
材料	3mm鋁板	復核	謝永林	2022.03.15	日期		
顏色	EC-DG-D334232-ZD1	批准	Daniel		圖號	CW-GL01	

EG-DWG3

美特鋁質有限公司
 MIDI Aluminium Fabricator Ltd.

工程號 J853 地盤 延坪道

物料編號	使用位置	數量
CW-GL02	T1	56
	T2	50
	T3	50
	T6	40
	T7	30

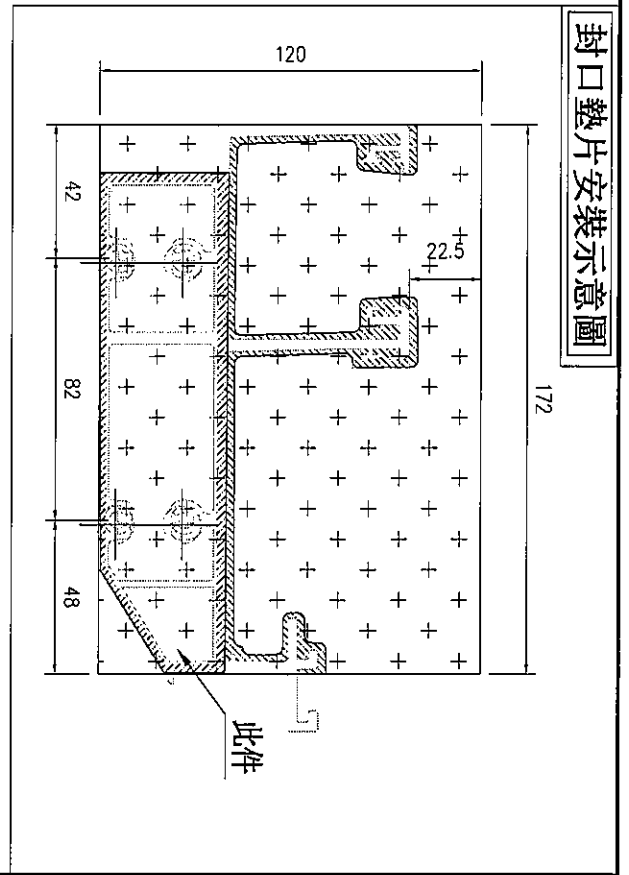
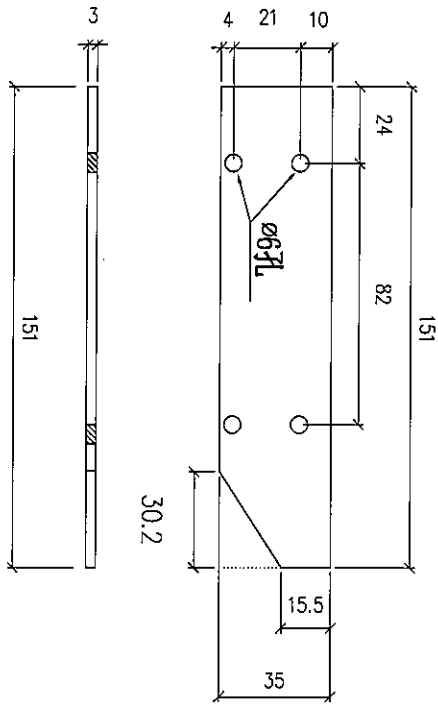

封口墊片安裝示意圖

名稱	封口墊片	制圖	陳敏聰	2022.03.05	修改		
材料	3mm鋁板	復核	謝永林	2022.03.15	日期		
顏色	MILL	批准	Daniel		圖號	CW-GL02	

R.D. REF :

請用A3紙打印

CLIENT : **SHIMAO GROUP HOLDINGS LIMITED**
 ARCHITECT : **WORKS TIME & PARTNERS LIMITED**
 MAIN CONTRACTOR : **德興建築有限公司**
 STRUCTURAL ENGINEER : **CH WONG & ASSOCIATES LTD**
 FACADE CONSULTANT : **MEINHARDT**

NOTE:
 1. ALL DIMENSIONS ARE IN METRE.
 2. ALL ELEVATIONS ARE WORKED FROM OUTSIDE.
 3. ALL DIMENSIONS TO BE VERIFIED ON SITE BEFORE FABRICATION.

LEGEND:
 1. RETAIN MARK NO.
 2. REFER SHEET NO.
 1. F.F.L. --- FINISHED FLOOR LEVEL
 2. S.F.L. --- STRUCTURAL FLOOR LEVEL
 3. --- HANDED DETAIL

PROJECT : PROPOSED RESIDENTIAL DEVELOPMENT AT N.K.L. 6542 YUN FANG ROAD, KOWLOON.

TITLE : PART ELEVATION OF CURTAIN WALL AT TOWER 1

DATE : 19-MAR-21 SCALE : 1:60 (A1)

DRAWN BY : JHR CHECKED BY : --

REV. : A

UNIT NO. : J-453

REVISION SUBJECT BY DATE

REV. : A

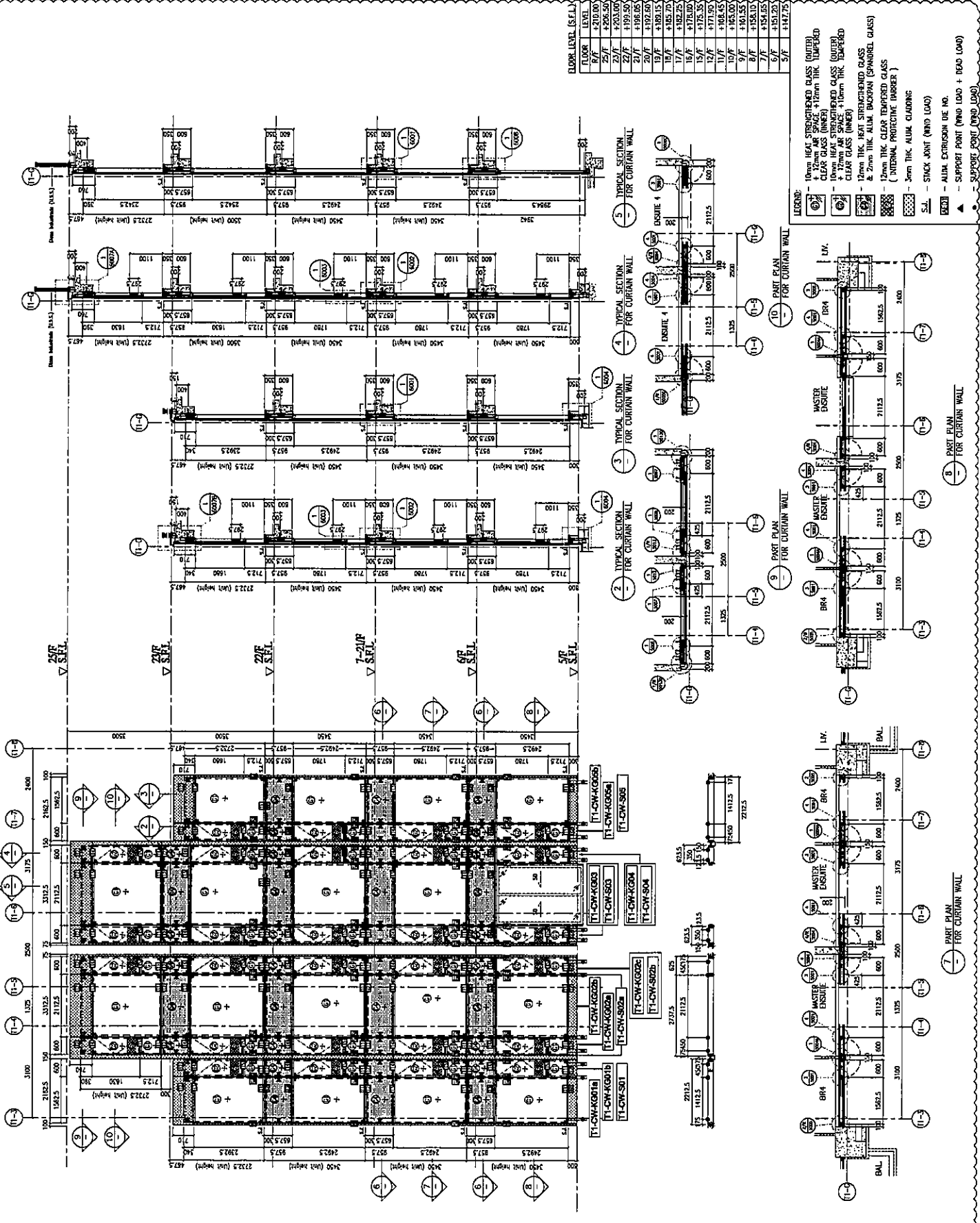

B.D. REF :

請用A3紙打印

CLIENT :

SHIMAO GROUP HOLDINGS LIMITED

ARCHITECT :

YONG TUNG & PARTNERS LIMITED



MAIN CONTRACTOR :

SHIP HING CONSTRUCTION CO. LTD

STRUCTURAL ENGINEER :

CMA C H WONG & ASSOCIATES LTD

FAOCC CONSULTANT :

MEINHARDT

NOTE :

1. ALL DIMENSIONS ARE IN METRE.
2. ALL ELEVATIONS ARE VIEWED FROM OUTSIDE.
3. ALL DIMENSIONS TO BE VERIFIED ON SITE BEFORE FABRICATION.

LEGEND :

- 1. DETAIL WORK NO.
- 2. REFER SHEET NO.
- 1. F.F.L. --- FINISHED FLOOR LEVEL.
- 2. S.F.L. --- STRUCTURAL FLOOR LEVEL.
- 3. --- REVERSED DETAIL.

NO.	DESCRIPTION	DATE	BY
1	ISSUED FOR PERMIT TO WORK, CONCEPT		

PROJ. NO. : J-653

PROJECT : PROPOSED RESIDENTIAL DEVELOPMENT AT N.K.L.L. 6542

YIN PING ROAD, KOWLOON

TITLE : PART ELEVATION FOR CURTAIN WALL AT TOWER 1

DRAWN BY : L.H.R.

SCALE : 1:80 (A1)

DATE : 18-MAR-21

REV. : A

美特銳有限公司

MIDI AUTOMATIC MANUFACTURE LTD.

Units 6-8, Sunny Industrial Centre, 1/F

142-148Belt 1-1, Tel: (852) 2727666

FIG. NO. : 0553-SD-CN-4102

REV. : A

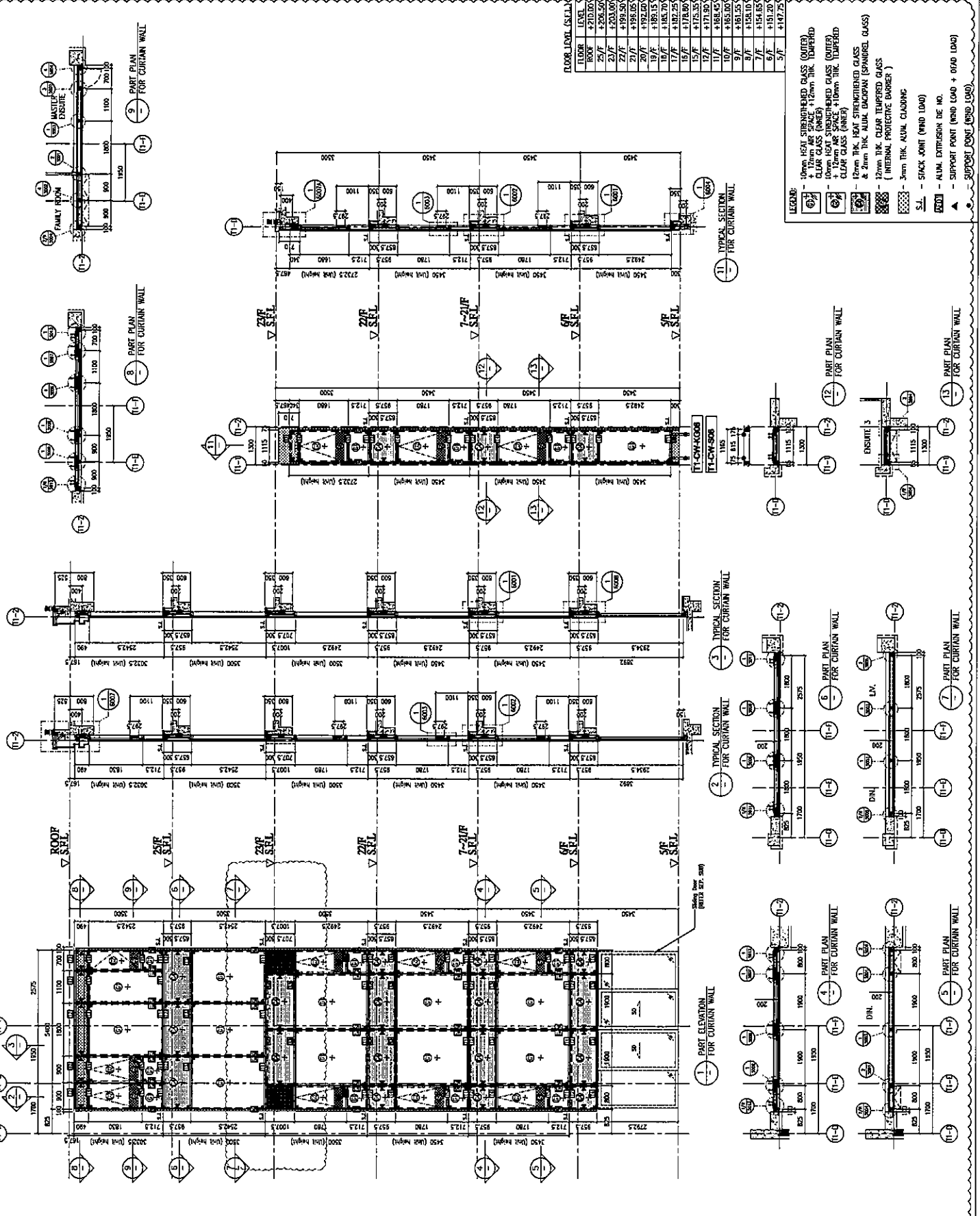

FLOOR LEVEL	LEVEL
ROOF	+210.00
25/F	+206.50
22/F	+203.00
21/F	+199.50
20/F	+196.00
19/F	+192.50
18/F	+189.00
17/F	+185.50
16/F	+182.00
15/F	+178.50
14/F	+175.00
13/F	+171.50
12/F	+168.00
11/F	+164.50
10/F	+161.00
9/F	+157.50
7/F	+154.00
6/F	+150.50
5/F	+147.00

- LEGEND:
- ① 10mm HEAT STRENGTHENED GLASS (OUTER) + 12mm AIR SPACE + 12mm THK. TEMPERED CLEAR GLASS (INNER)
 - ② 10mm HEAT STRENGTHENED GLASS (OUTER) + 12mm AIR SPACE + 12mm THK. TEMPERED CLEAR GLASS (INNER)
 - ③ 12mm THK. HEAT STRENGTHENED GLASS & 2mm THK. ALUM. DACOPAN (SPANNER GLASS) (INTERNAL PROTECTIVE BARRIER)
 - ④ 3mm THK. ALUM. CLOSING
 - ⑤ S.L. - STACK JOINT (WIND LOAD)
 - ⑥ ALUM. EXTRUSION (WIND LOAD)
 - ⑦ SUPPORT POINT (WIND LOAD + DEAD LOAD)
 - ⑧ SUPPORT POINT (WIND LOAD)

R.D. REF :

請用A3紙打印

CLIENT : SHIMAO GROUP HOLDINGS LIMITED
 ARCHITECT : WONG TUNG & PARTNERS LIMITED
 MAIN CONTRACTOR : 協興建築有限公司
 SHIMAO BUILDING CONSTRUCTION CO. LTD

STRUCTURAL ENGINEER : CH WONG & ASSOCIATES LTD
 黃志祥建築工程師有限公司
 PROJECT CONSULTANT : MEINHARDT

NOTE:
 1. ALL DIMENSIONS ARE IN METR.
 2. ALL ELEVATIONS ARE VIEWED FROM OUTSIDE.
 3. ALL DIMENSIONS TO BE VERIFIED ON SITE BEFORE FABRICATION.

LEGEND:
 (1) - ORIGINAL WORK NO.
 (2) - REFER SHEET NO.
 1. F.F.L. --- FINISHED FLOOR LEVEL
 2. S.F.L. --- STRUCTURAL FLOOR LEVEL
 3. --- REVERSED DETAIL

FLOOR	LEVEL	REMARKS SUBJECT TO A/E/C COMMENT	REVISED	NO.
10/F	210.00			
9/F	206.50			
8/F	203.00			
7/F	199.50			
6/F	196.00			
5/F	192.50			
4/F	189.00			
3/F	185.50			
2/F	182.00			
1/F	178.50			
0/F	175.00			
10/F	161.50			
9/F	158.00			
8/F	154.50			
7/F	151.00			
6/F	147.50			
5/F	144.00			

PROJECT : PROPOSED RESIDENTIAL DEVELOPMENT AT N.K.L.L. 6542
 YIN PING ROAD
 KOWLOON

TITLE : PART ELEVATION FOR CURTAIN WALL AT TOWER 1

DATE : 18-MAR-21 SCALE : 1:80 (A1)
 DRAWN BY : LHR CHECKED BY :
 美特鋁質有限公司
 MIDTI ALUMINIUM MANUFACTURE LTD.
 Units 6-8, Sunny Industrial Centre, 1/F
 #42-809211-1 TEL: (852) 27727668
 DWF NO. : JRS3-SD-CN-4103 REV. : A

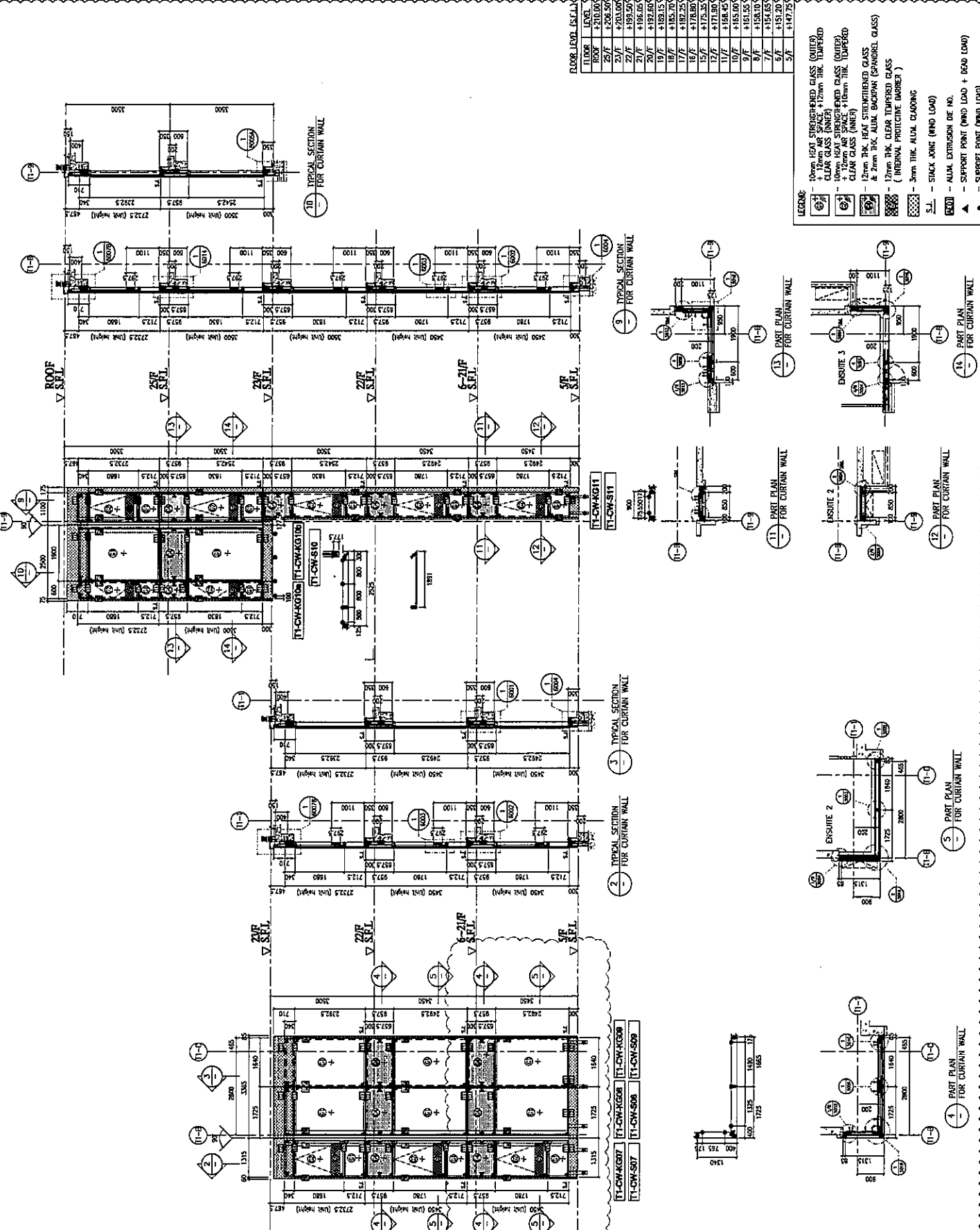

LEGEND:

- 10mm HEAT STRENGTHENED GLASS (OUTER) + 12mm AIR SPACE + 12mm THK. TEMPERED CLEAR GLASS (INNER)
- 12mm HEAT STRENGTHENED GLASS (OUTER) + 12mm AIR SPACE + 12mm THK. TEMPERED CLEAR GLASS (INNER)
- 12mm THK. HEAT STRENGTHENED GLASS & 2mm THK. ALUM. BACKUP (SPANDREL GLASS) (INTERNAL PROTECTIVE BARRIER)
- 3mm THK. ALUM. CLADDING
- S.L. --- STACK JOINT (WIND LOAD)
- ALUM. EXTRUSION (WIND LOAD)
- SUPPORT POINT (WIND LOAD + DEAD LOAD)
- SUPPORT POINT (WIND LOAD)

TI-CW-RGB07 TI-CW-RGB08 TI-CW-RGB09
 TI-CW-S07 TI-CW-S08 TI-CW-S09

B.D. REF :

請用A3紙打印

CLIENT : SHIMAO GROUP HOLDINGS LIMITED

ARCHITECT : WING YING & PARTNERS LIMITED

MAIN CONTRACTOR : 德興建築有限公司

STRUCTURAL ENGINEER : CMA CH WONG & ASSOCIATES LTD

FAÇADE CONSULTANT : MEINHARDT

NOTE: 1. ALL DIMENSIONS ARE IN METERS. 2. ALL ELEVATIONS ARE VIEWED FROM OUTSIDE. 3. ALL DIMENSIONS TO BE VERIFIED ON SITE BEFORE FABRICATION.

LEGEND: 1. DETAIL MARK NO. REFER SHEET NO. 2. F.F.L. - FINISHED FLOOR LEVEL. 3. S.F.L. - STRUCTURAL FLOOR LEVEL. 4. - REVERSED DETAIL.

Table with 2 columns: FLOOR LEVEL (S.F.L.), FLOOR LEVEL (F.F.L.). Rows include ROOF, 25/F, 20/F, 15/F, 10/F, 5/F, 0/F, 1/F, 2/F, 3/F, 4/F, 5/F, 6/F, 7/F, 8/F, 9/F, 10/F, 11/F, 12/F, 13/F, 14/F, 15/F, 16/F, 17/F, 18/F, 19/F, 20/F, 21/F, 22/F, 23/F, 24/F, 25/F.

PROJECT : PROPOSED RESIDENTIAL DEVELOPMENT AT NICKELL 6542 YUN PING ROAD KOWLOON

TITLE : PART ELEVATION FOR CURTAIN WALL AT TOWER 1

DATE : 18-MAR-21 SCALE : 1:80 (A1)

DRAWN BY : LHR CHECKED BY : MIDTI 美特銘有限公司

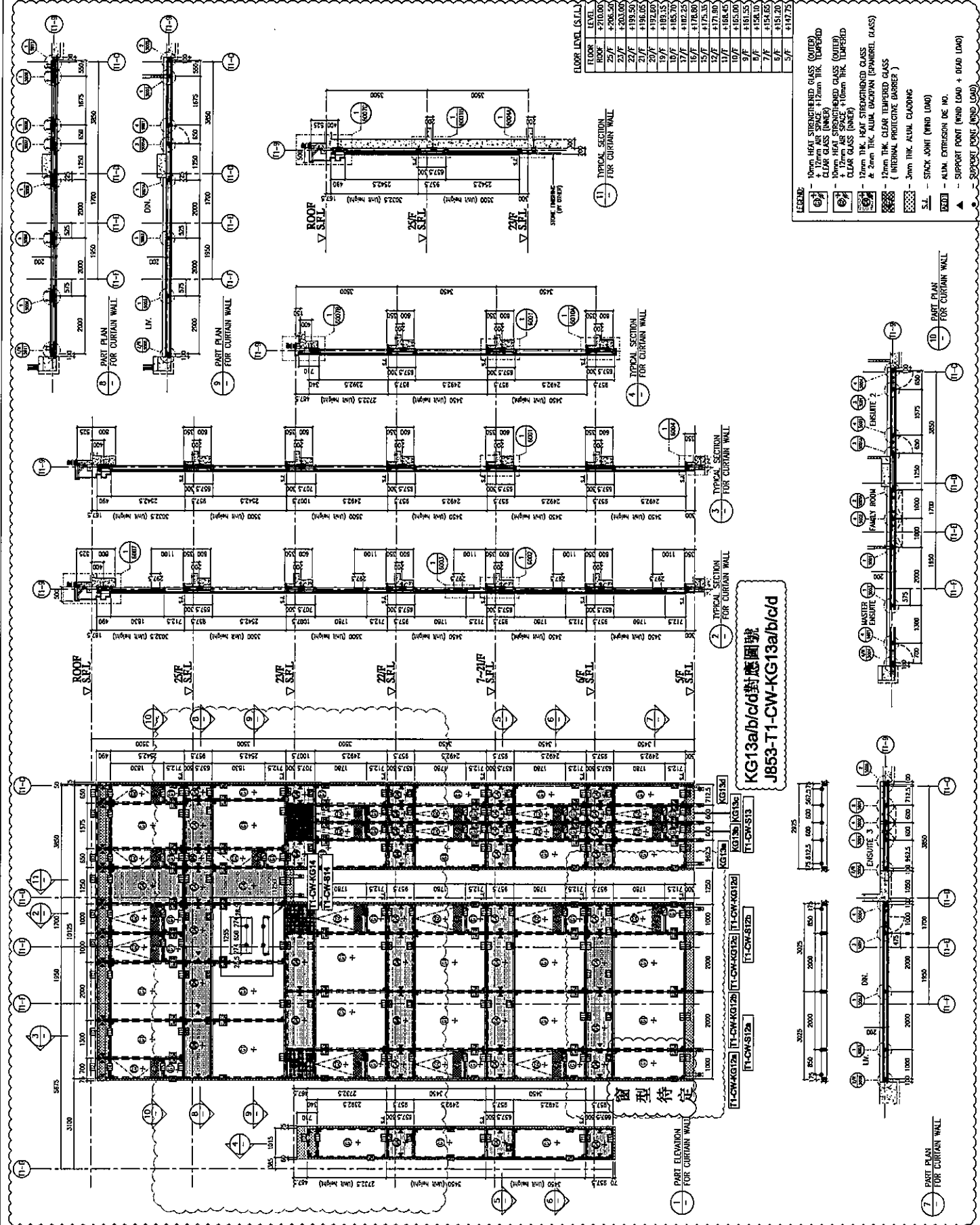

LEGEND: 10mm HEAT STRENGTHENED GLASS (OUTER) + 12mm AIR SPACE + 12mm THK. TEMPERED CLEAR GLASS (INNER) + 12mm AIR SPACE + 10mm THK. INSULATED CLEAR GLASS (INNER) + 2mm THK. HEAT STRENGTHENED GLASS & 2mm THK. ALUM. JACKPAN (SPANNEL GLASS) - 12mm THK. CLEAR TEMPERED GLASS (INTERNAL PROTECTIVE BARRIER) - 3mm THK. ALUM. CLADDING

S.S. - STACK JOINT (WIND LOADING) ALUM. EXTRUSION (WIND LOADING) SUPPORT POINT (WIND LOAD + DEAD LOAD) SUPPORT POINT (WIND LOAD)

KG13a/b/c/d對應圖號 J853-T1-CW-KG13a/b/c/d

窗型特定

S.D. REF :

請用A3紙打印

CLIENT : SHIMAO GROUP HOLDINGS LIMITED

ARCHITECTS : HONG TUNG & PARTNERS LIMITED



MAIN CONTRACTOR : 協興建築有限公司 HOP HING CONSTRUCTION CO. LTD

STRUCTURAL ENGINEER : CMA CH WONG & ASSOCIATES LTD 香港測量師工程師有限公司



NOTE: 1. ALL DIMENSIONS ARE IN METERS. 2. ALL ELEVATIONS ARE VIEWED FROM OUTSIDE. 3. ALL DIMENSIONS TO BE VERIFIED ON SITE BEFORE FABRICATION.

LEGEND: 1. F.F.L. — FINISHED FLOOR LEVEL 2. S.F.L. — STRUCTURAL FLOOR LEVEL 3. — REVERSED DETAIL

1. LOCAL WORK NO. 2. REFER SHEET NO.

FLOOR LEVEL (S.F.L.)	LEVEL
FLOOR	+270.00
ROOF	+276.50
25/F	+226.50
23/F	+203.00

PROJECT : PROPOSED RESIDENTIAL DEVELOPMENT AT MKCL L. 6542 YUK PING ROAD KOHLOON

TITLE : PART ELEVATION FOR CURTAIN WALL AT TOWER 1

DATE : 02-OCT-21 SCALE : 1:60 (A1)

DRAWN BY : LHR CHECKED BY :

MEI TONG HOLDINGS LIMITED (MIDI) 美特頓有限公司 Units 6-8, Sunny Industrial Centre, 1/F, 110, Chee Yee Hong Road, Kowloon. Tel: (852) 2508111-4, Fax: (852) 7722666

UNG NO. : J853-SD-CW-4106 REV. : A

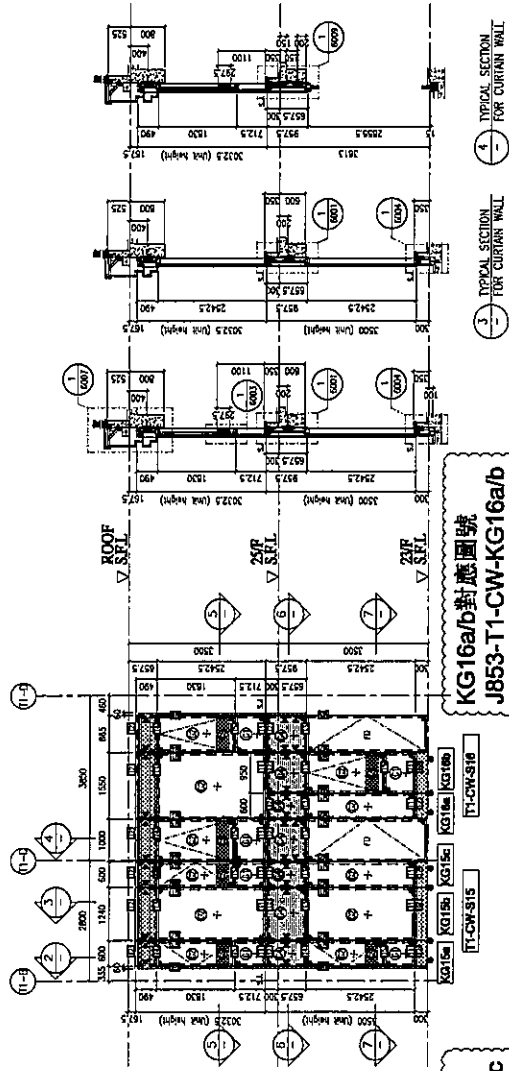

KG15a/b/c對應圖號 J853-T1-CW-KG15a/b/c

KG16a/b對應圖號 J853-T1-CW-KG16a/b

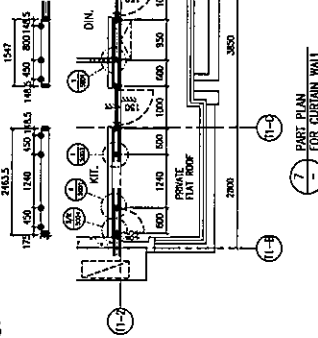

7 PART PLAN FOR CURTAIN WALL

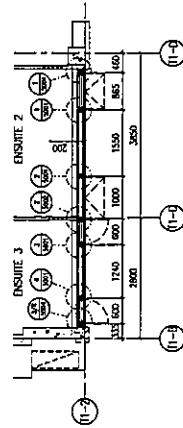

5 PART PLAN FOR CURTAIN WALL

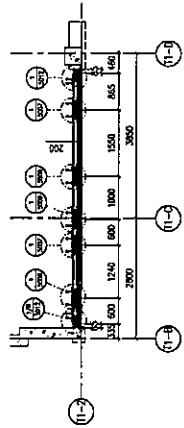

4 TYPICAL SECTION FOR CURTAIN WALL

3 TYPICAL SECTION FOR CURTAIN WALL

- LEGEND:
- 10mm HEAT STRENGTHENED GLASS (OUTER) + 12mm AIR SPACE + 12mm THK. TEMPERED CLEAR GLASS (INNER)
 - 12mm HEAT STRENGTHENED GLASS (OUTER) + 12mm AIR SPACE + 12mm THK. UNTEMPERED CLEAR GLASS (INNER)
 - 12mm THK. HEAT STRENGTHENED GLASS & 2mm THK. ALUM. BACKPAN (SPANDREL GLASS)
 - 1200mm THK. CLEAR TEMPERED GLASS (INTERNAL PROTECTIVE BARRIER)
 - 3mm THK. ALUM. CLOSING
 - S.S. — STACK JOINT (WIND LOAD)
 - ALUM. EXTRUSION DE. NO.
 - SUPPORT POINT (WIND LOAD + DECK LOAD)
 - SUPPORT POINT (WIND LOAD)

美特鋁質有限公司
MIDI Aluminium Fabricator Ltd.

工程號 J853 地盤 延坪道

數量: 1

封口片 (鋁片)
安裝示意圖見:
CW-810/02

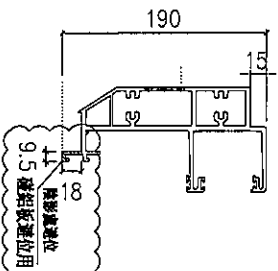
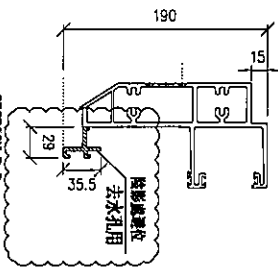
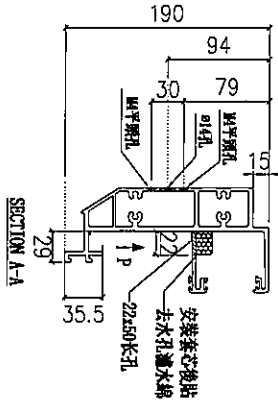
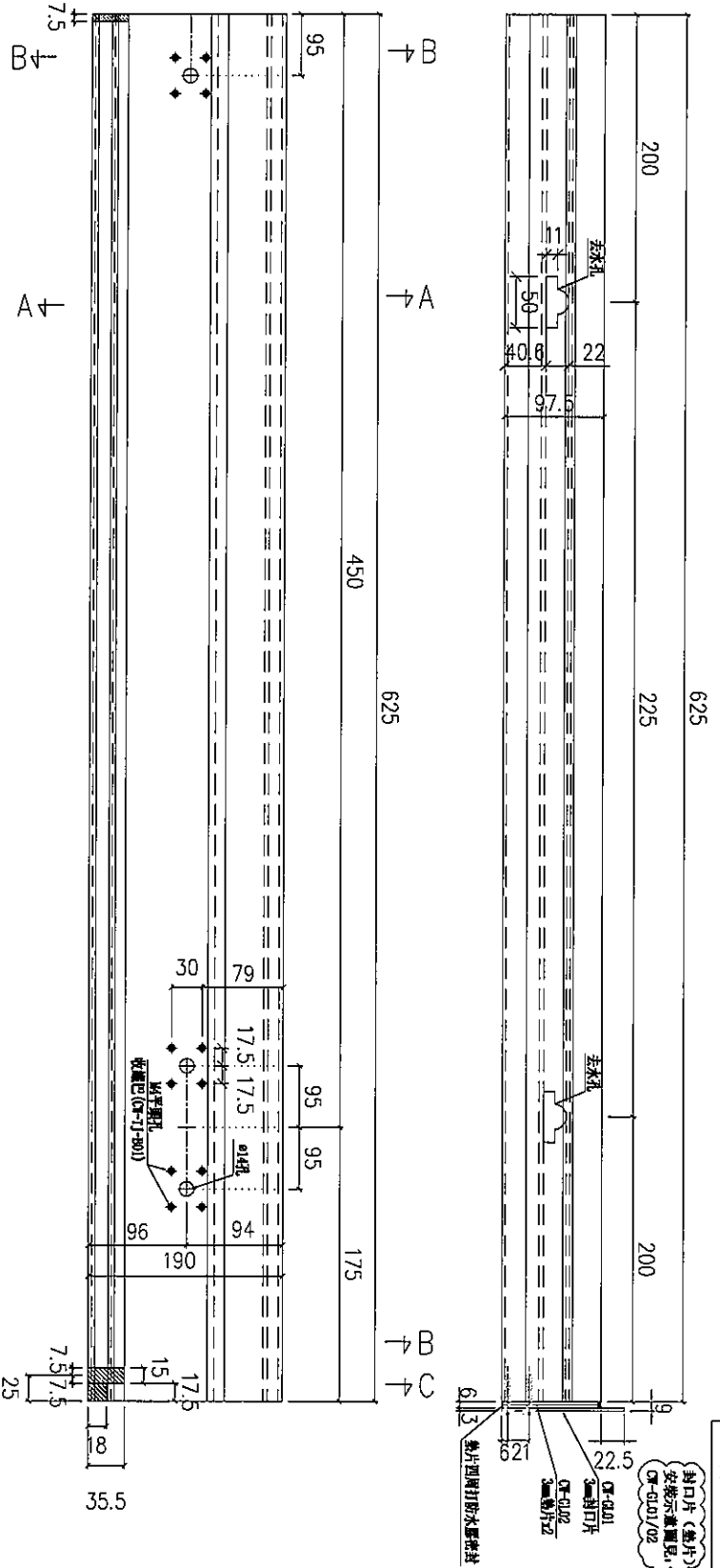

安裝示意圖

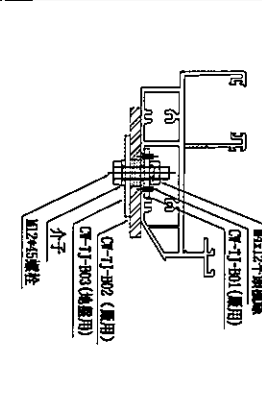

名稱	頂橫	制圖	陳敏聰	2022.03.15	修改	
材料	X85982	復核	謝永林	2022.03.21	日期	
顏色	JMQ213457(3 coatings)	批准			圖號	J853-T1-CW-S02b



美特鋁質有限公司
MIDI Aluminium Fabricator Ltd.

工程號 J853 地盤 延坪道

請用A3紙打印

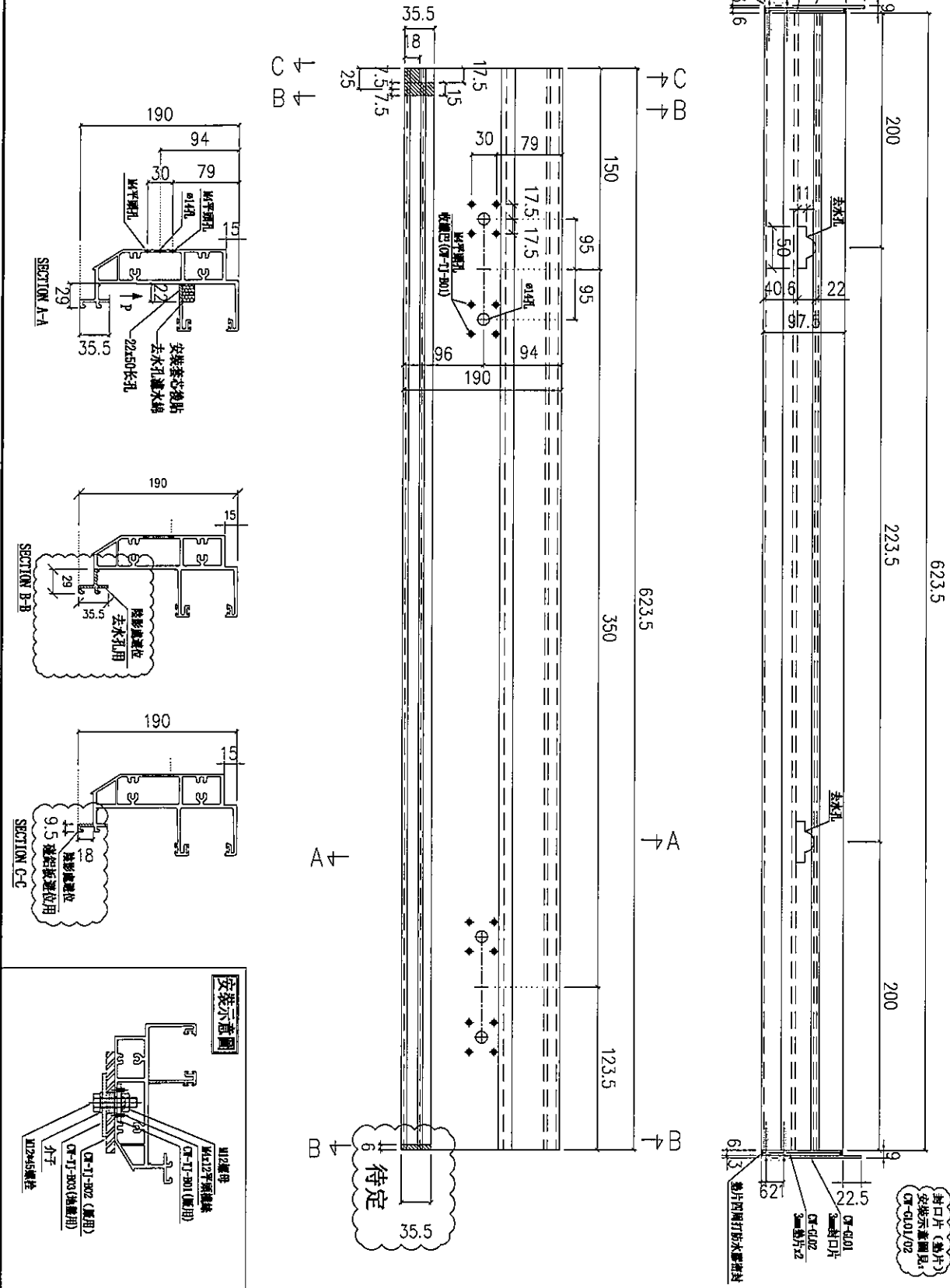

使用位置 J853-SD-CW-4101

數量: 1

名稱	頂橫	制圖	陳敏聰	2022.03.15	修改
材料	X85982	復核	謝永林	2022.03.21	日期
顏色	JMQ213457(3 coatings)	批准			圖號 J853-T1-CW-S03



美特鋁質有限公司
MIDI Aluminium Fabricator Ltd.

工程號 J853 地盤 延坪道

請用A3紙打印

使用位置J853-SD-CW-4101

數量: 1

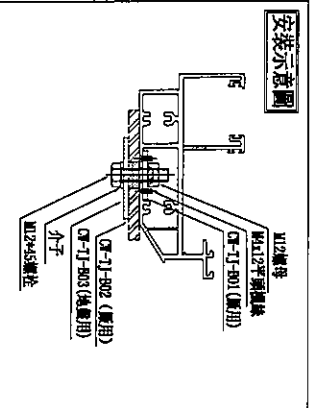
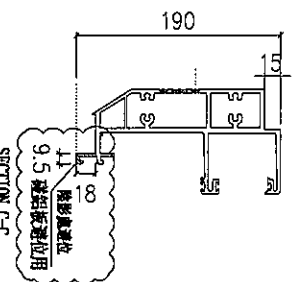
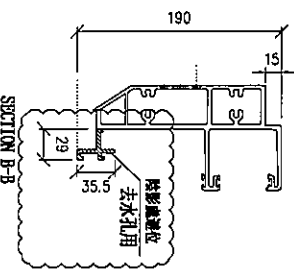
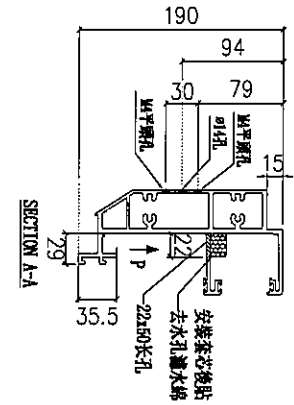
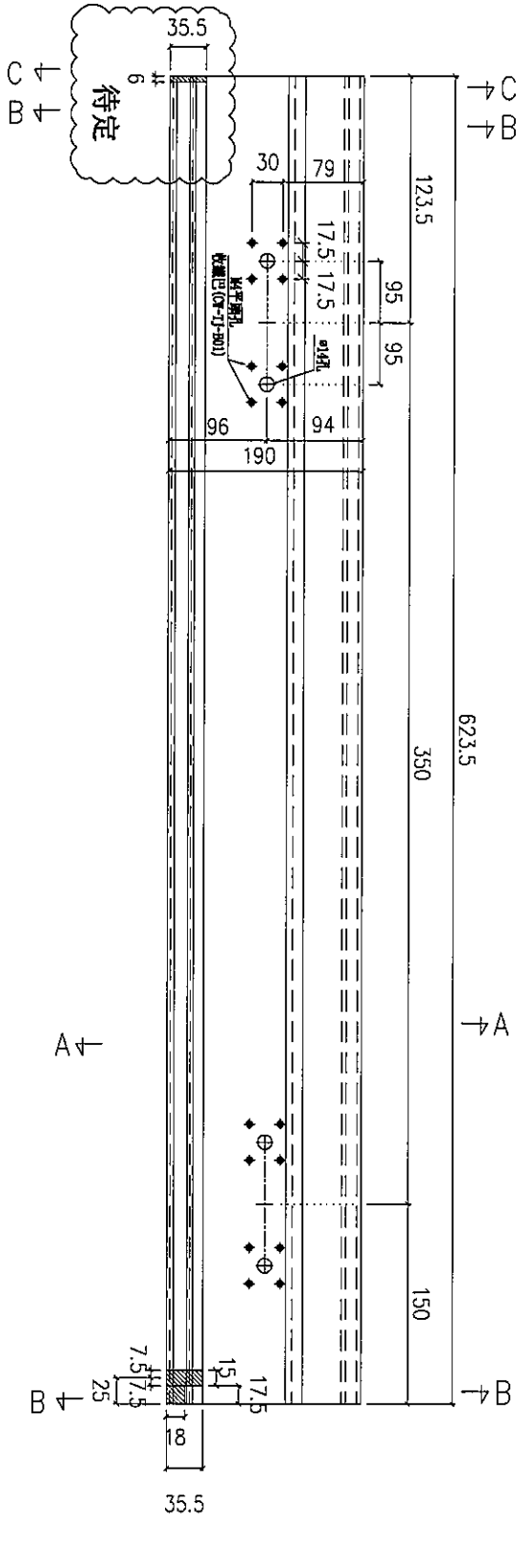
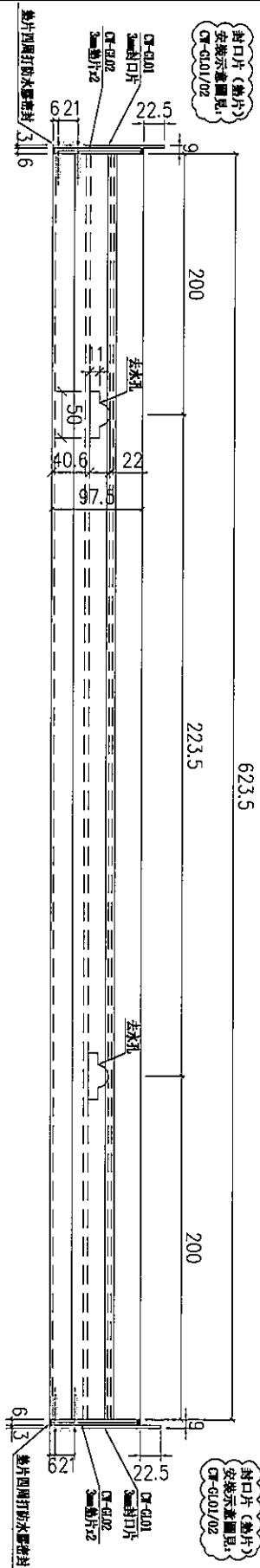

名稱	頂橫	制圖	陳敏聰	2022.03.15	修改
材料	X85982	復核	謝永林	2022.03.21	日期
顏色	JMQ213457(3 coatings)	批准			圖號 J853-T1-CW-S04



美特鋁質有限公司
MIDI Aluminium Fabricator Ltd.

工程號 J853 地盤 延坪道

請用A3紙打印

使用位置 J853-SD-CW-4101

數量: 1

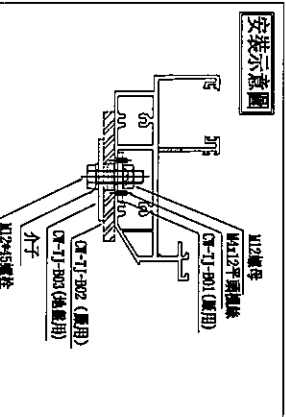
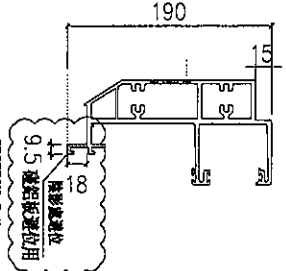
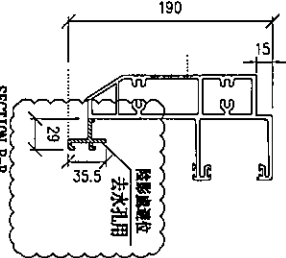
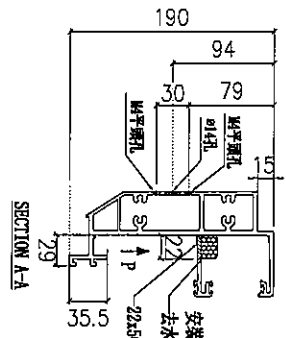
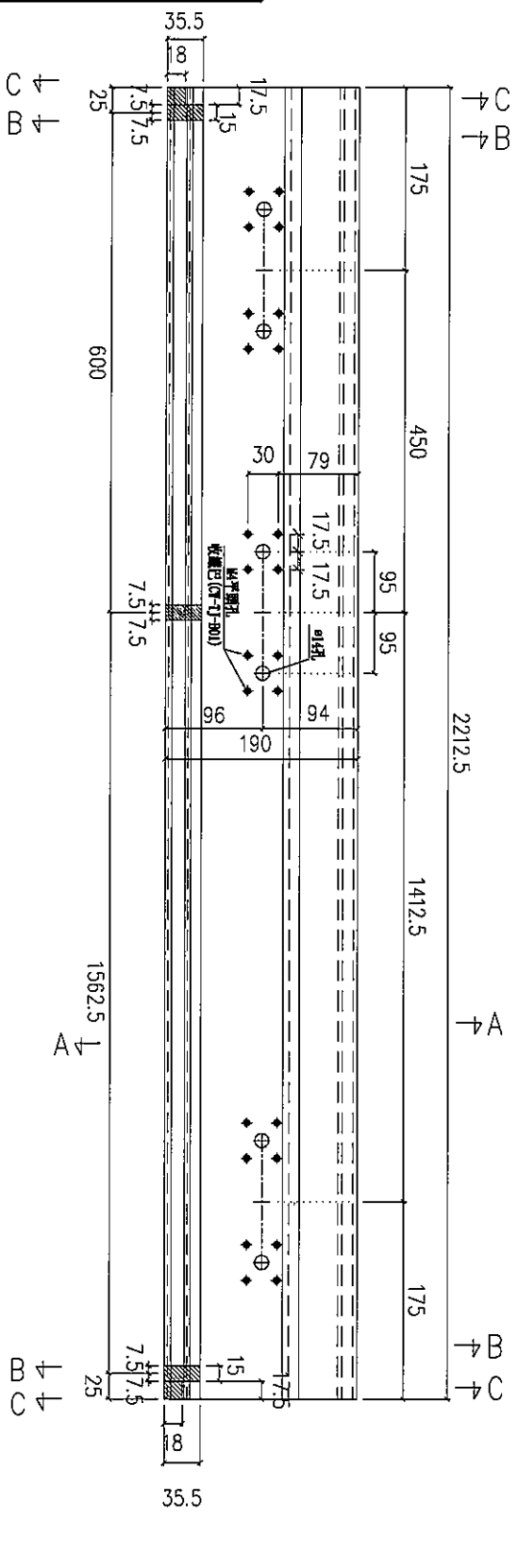
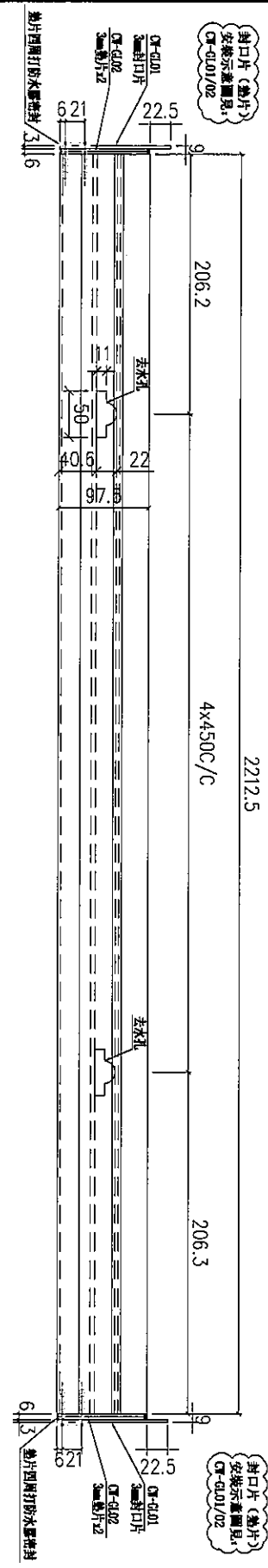

名稱	頂橫	制圖	陳敏聰	2022.03.15	修改	
材料	X85982	復核	謝永林	2022.03.21	日期	
顏色	JMQ213457(3 coatings)	批准			圖號	J853-T1-CW-S05



美特鋁質有限公司
MIDI Aluminium Fabricator Ltd.

工程號 J-853 地盤 延坪道

請用A3紙打印

封口片 (每片)
安裝示意圖見:
CF-010/02

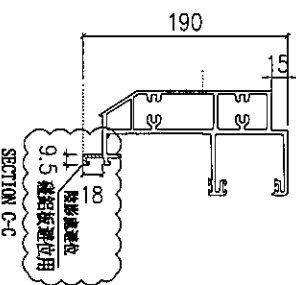
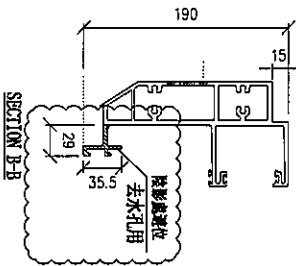
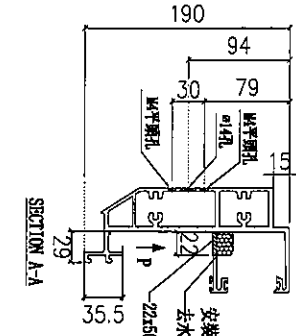

安裝示意圖

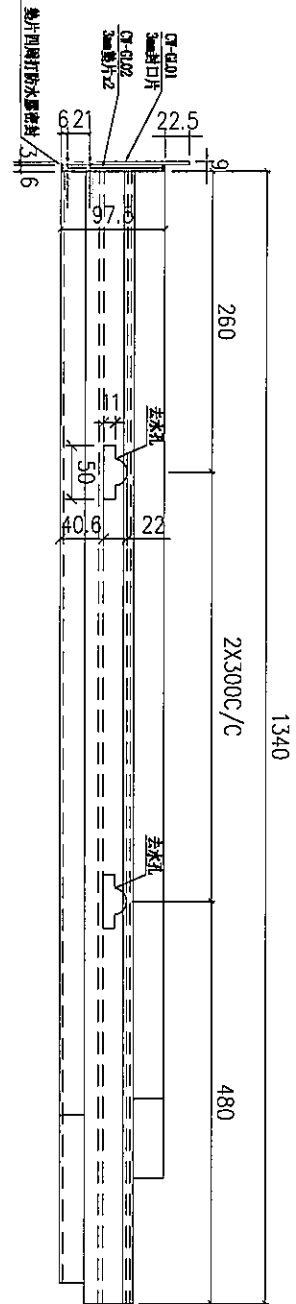
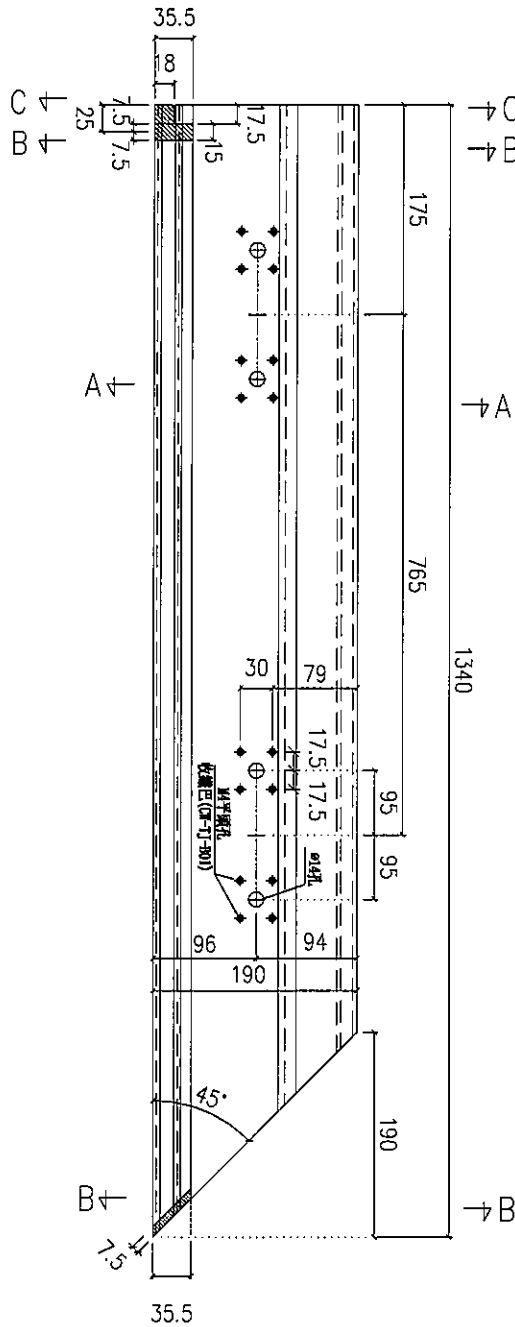
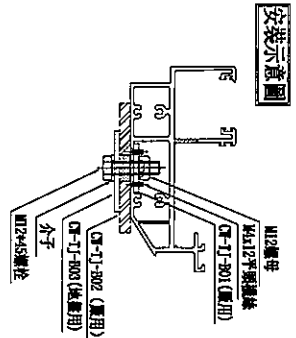

數量: 1

使用位置 J853-SD-CW-4103

名稱	頂橫	制圖	陳敏聰	2022.03.16	修改	
材料	X85982	復核	謝永林	2022.03.19	日期	
顏色	JMQ213457(3 coatings)	批准			圖號	J853-T1-CW-S07

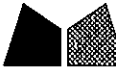

美特鋁質有限公司
MIDI Aluminium Fabricator Ltd.

工程號 J-853 地盤 延坪道

請用A3紙打印

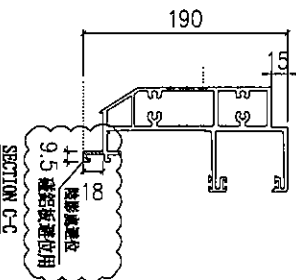
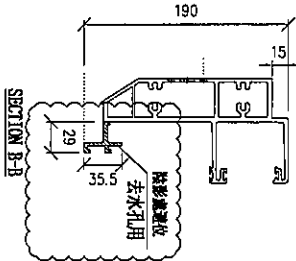
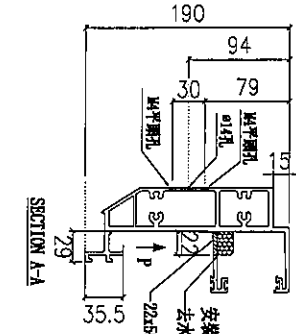

安裝示意圖

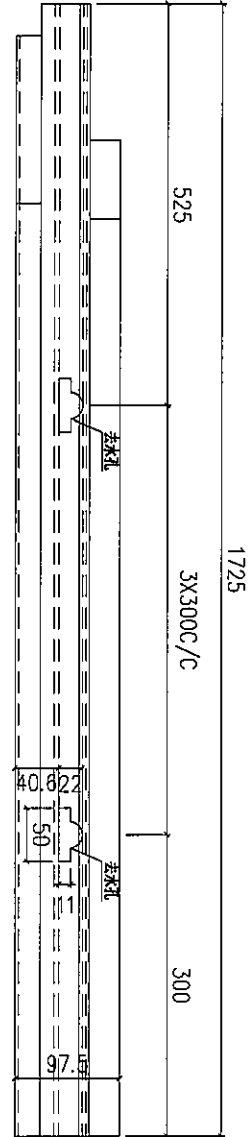
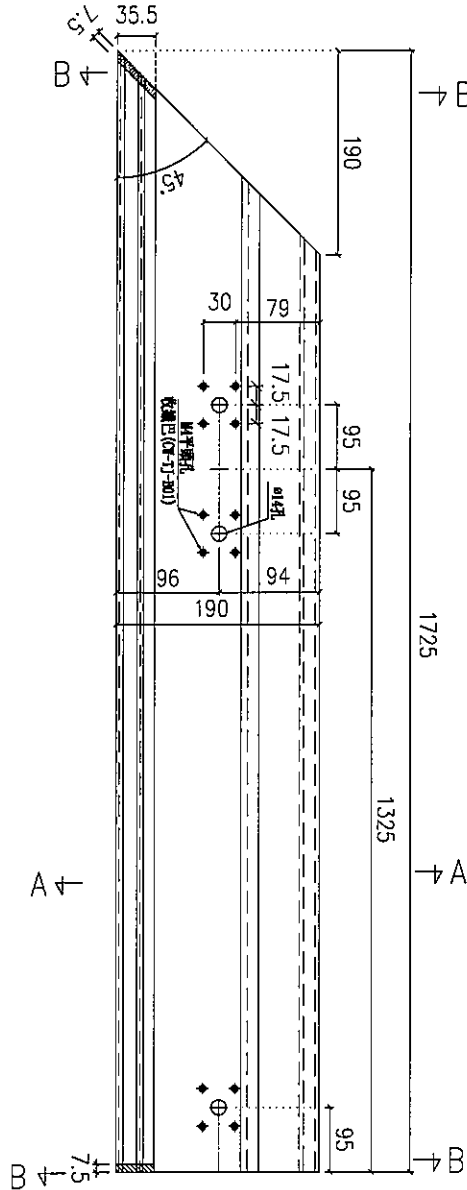
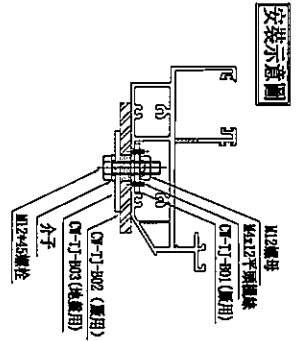

使用位置 J853-SD-CW-4103

數量: 1

名稱	頂橫	制圖	陳敏聰	2022.03.16	修改
材料	X85982	復核	謝永林	2022.03.19	日期
顏色	JMQ213457(3 coatings)	批准			圖號 J853-T1-CW-S08

美特鋁質有限公司
MIDI Aluminium Fabricator Ltd.

工程號 J853 地盤 延坪道

數量: 1

封口片 (黏片)
安裝不緊實請註
明 CW-4101/02

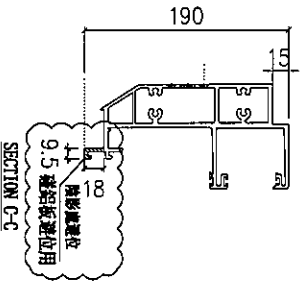
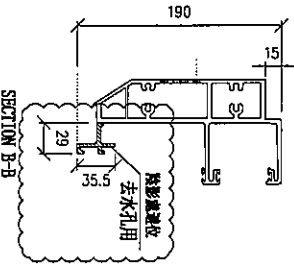
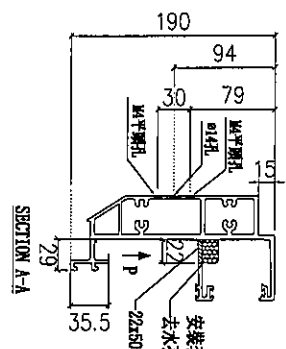
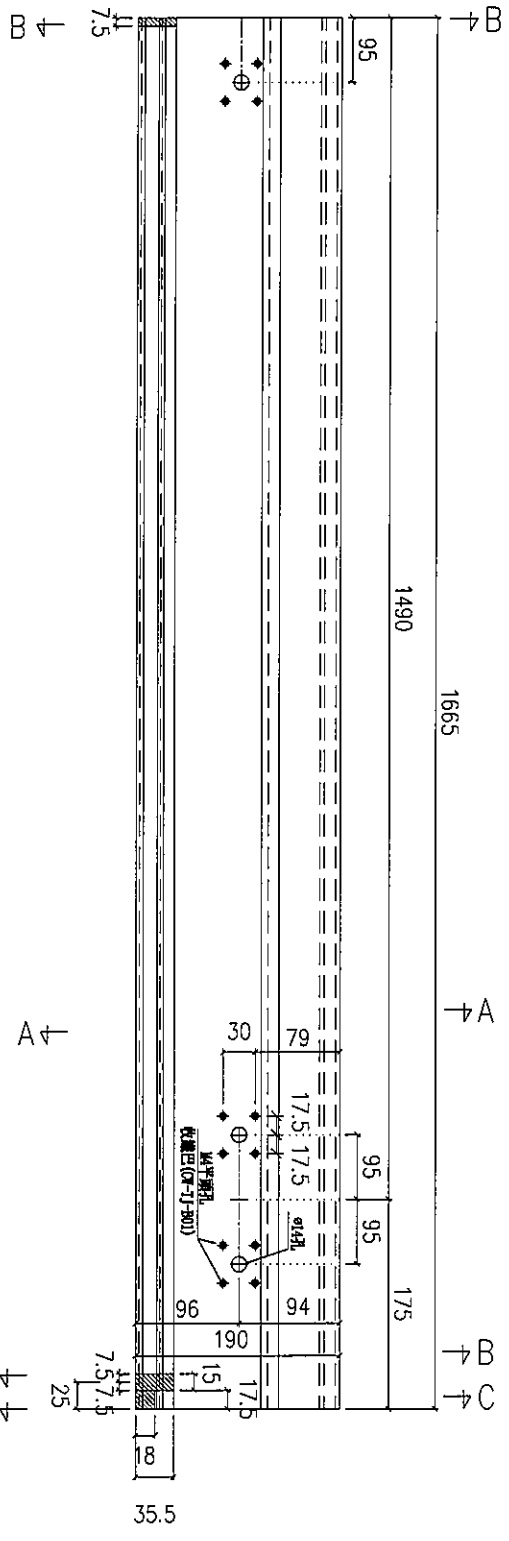
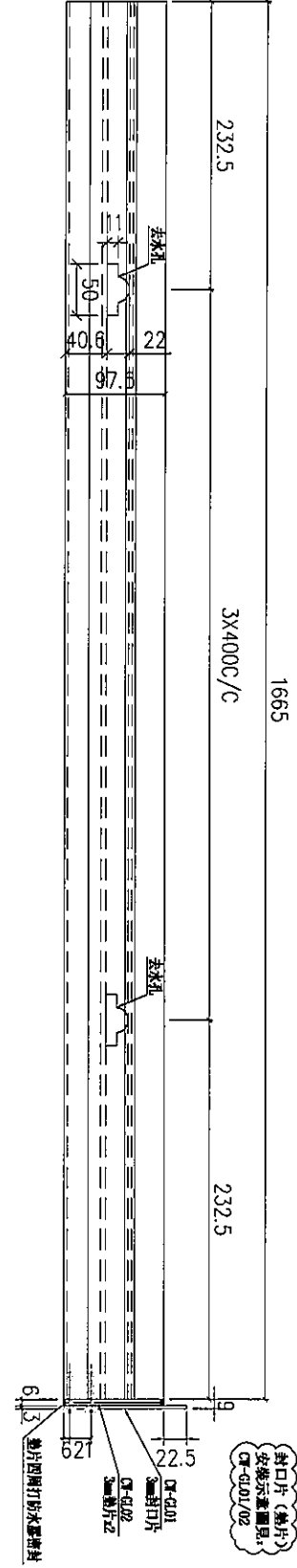

安裝示意圖

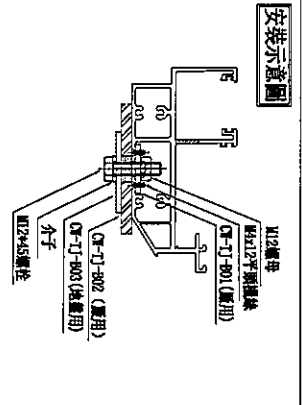

名稱	頂橫	制圖	陳敏聰	2022.03.15	修改
材料	X85982	復核	謝永林	2022.03.21	日期
顏色	JMQ213457(3 coatings)	批准			圖號 J853-T1-CW-S09

美特鋁質有限公司
MIDI Aluminium Fabricator Ltd.

工程號 J-853 地盤 延坪道

請用A3紙打印

封口片(墊片)
安裝示意圖見:
CF-G01/02

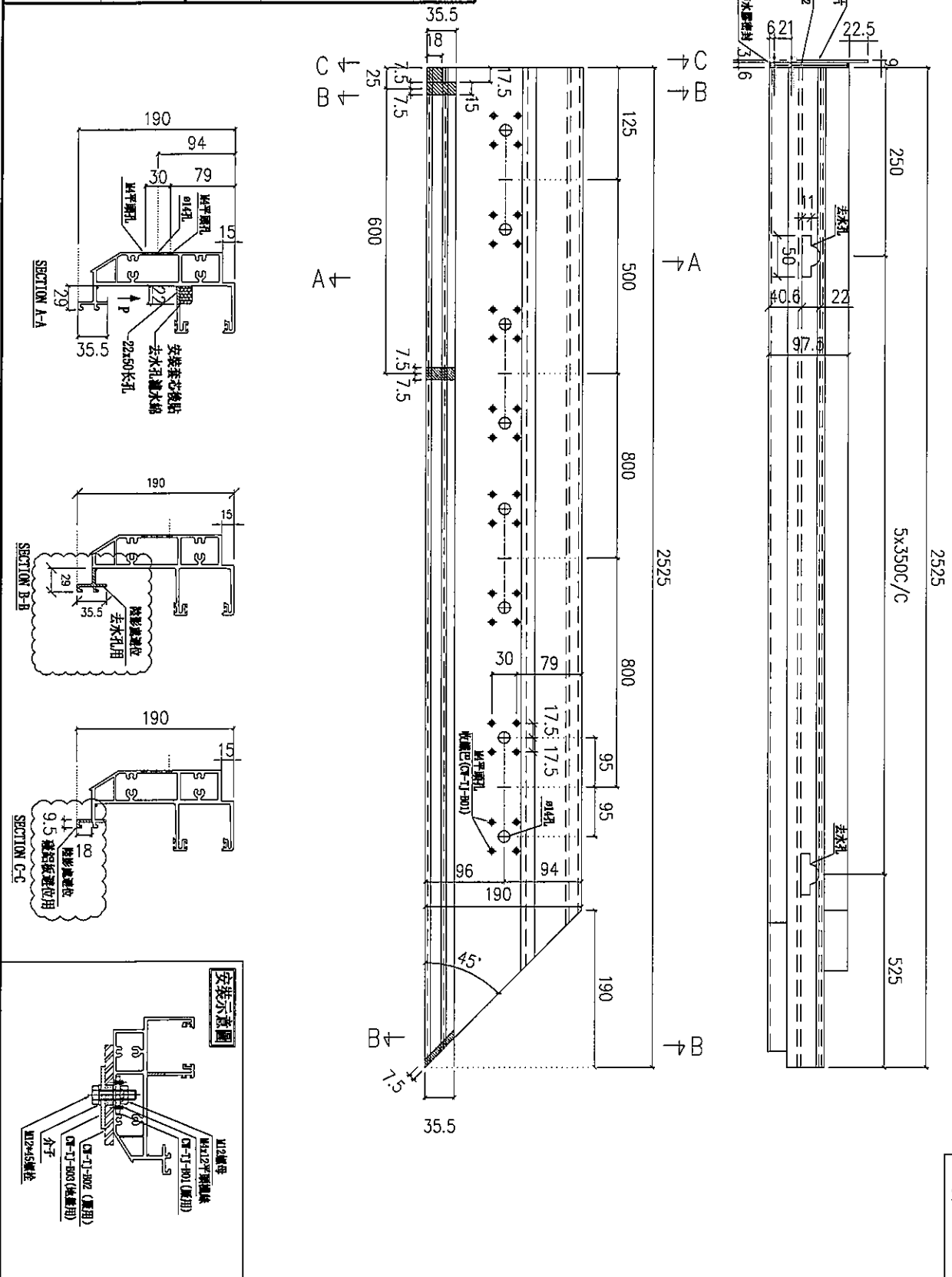

使用位置 J853-SD-CW-4103

數量: 1

名稱	頂橫	制圖	陳敏聰	2022.03.16	修改	
材料	X85982	復核	謝永林	2022.03.19	日期	
顏色	JMQ213457(3 coatings)	批准			圖號	J853-T1-CW-S10

美特鋁質有限公司
MIDI Aluminium Fabricator Ltd.

工程號 J853 地盤 延坪道

數量: 1

封口片 (黏片)
安裝示意圖見:
CW-0101/02

封口片 (黏片)
安裝示意圖見:
CW-0101/02

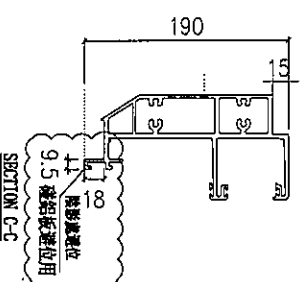
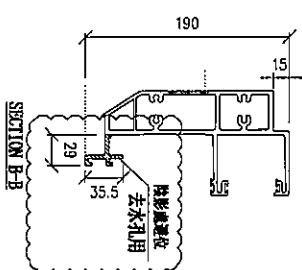
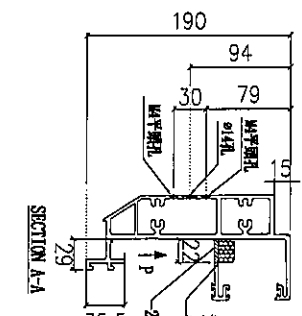
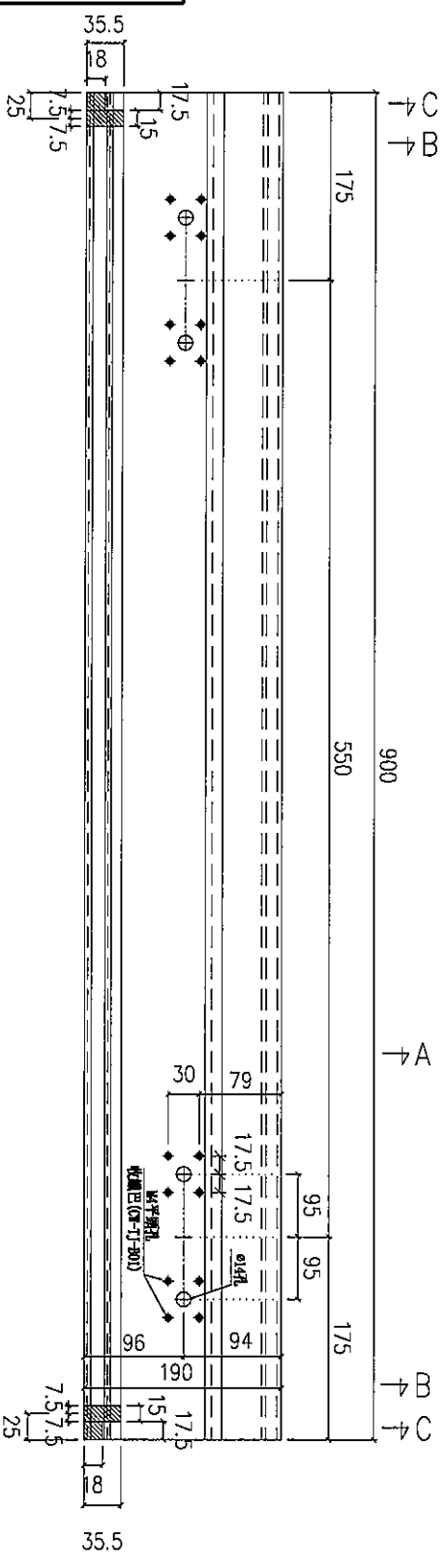
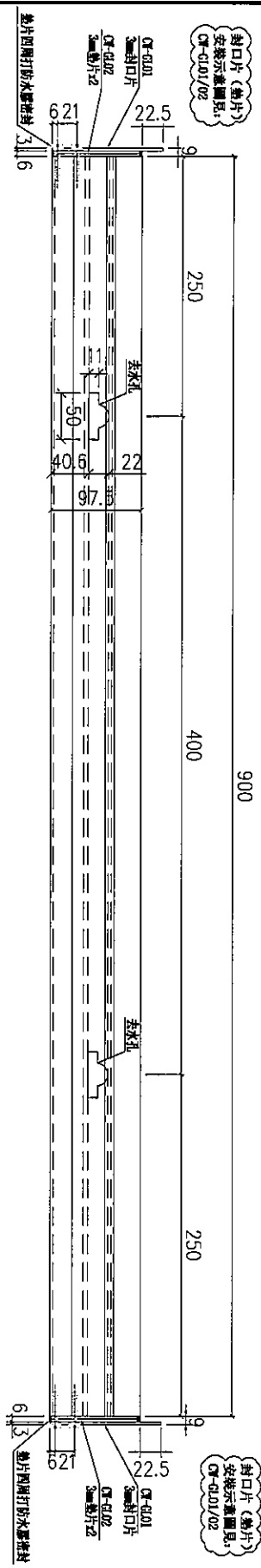

安裝示意圖

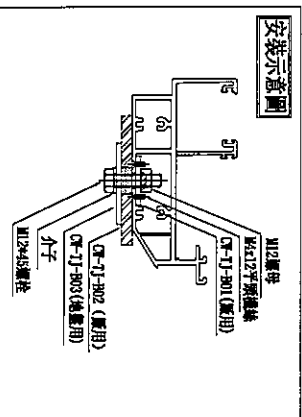

名稱	頂橫	制圖	陳敏聰	2022.03.15	修改
材料	X85982	復核	謝永林	2022.03.21	日期
顏色	JMQ213457(3 coatings)	批准			圖號 J853-T1-CW-S11



美特鋁質有限公司
MIDI Aluminium Fabricator Ltd.

工程號 J853 地盤 延坪道

請用A3紙打印

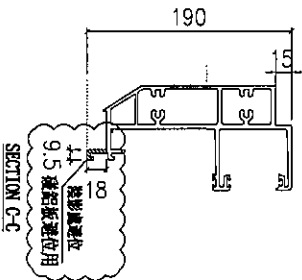
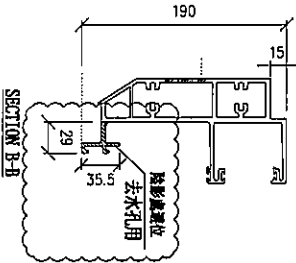
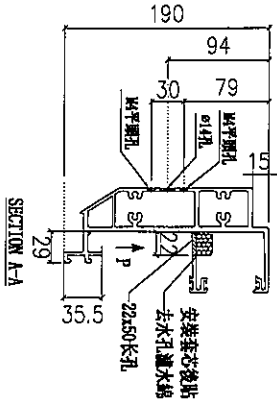
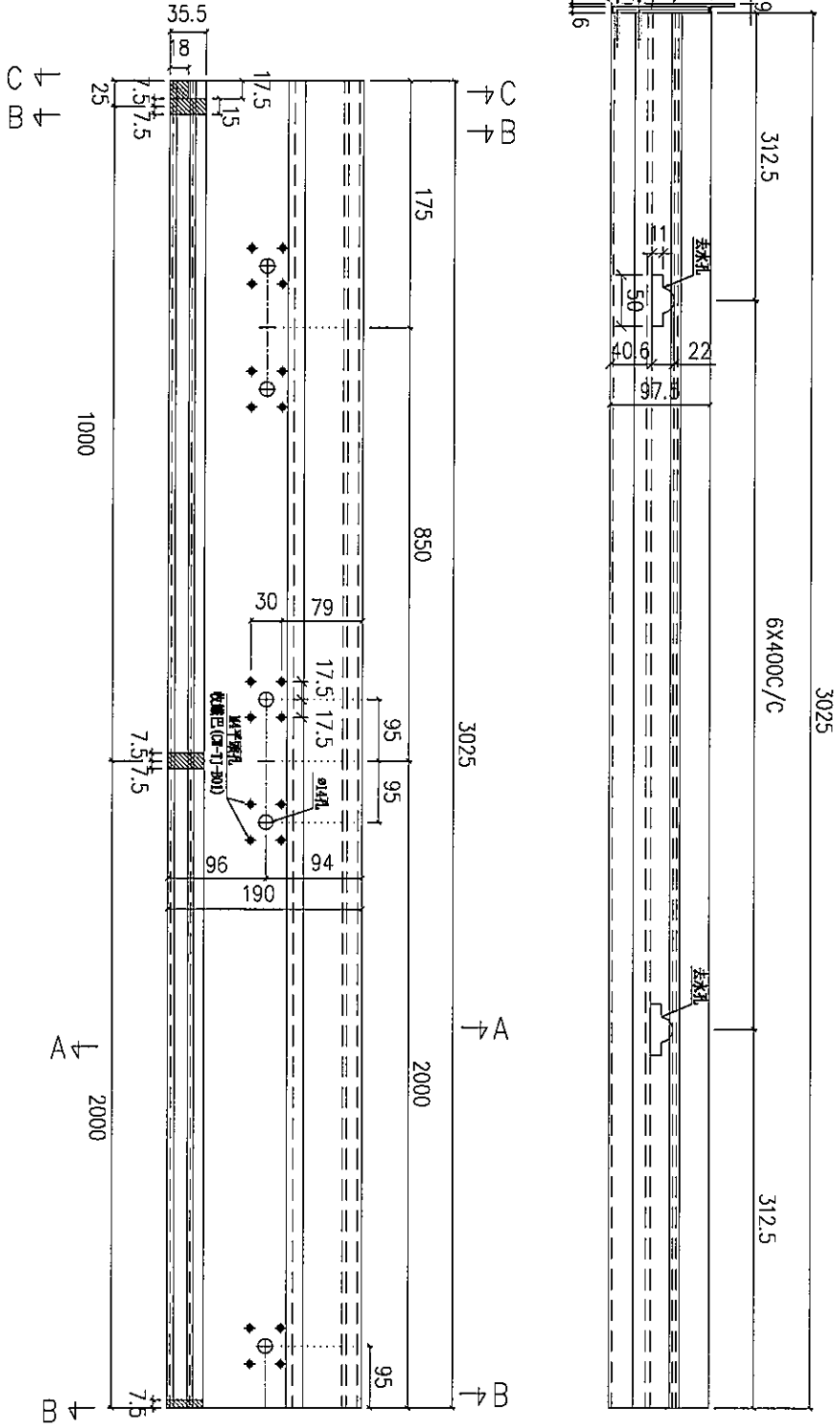
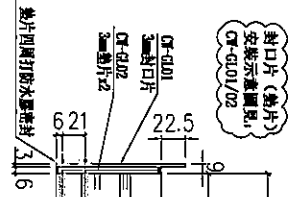

安裝示意圖

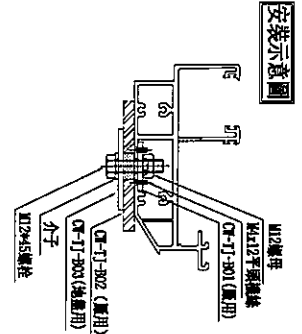

數量: 1

封口片 (封片) 安裝示意圖見: CW-0101/02

名稱	頂橫	制圖	陳敏聰	2022.03.15	修改
材料	X85982	復核	謝永林	2022.03.21	日期
顏色	JMQ213457(3 coatings)	批准			圖號 J853-T1-CW-S12a

使用位置 J853-SD-CW-4104

請用A3紙打印

使用位置J853-SD-CW-4104

數量: 1

美特鋁質有限公司
MIDI Aluminium Fabricator Ltd.

工程號	J853	地盤	延坪道
-----	------	----	-----

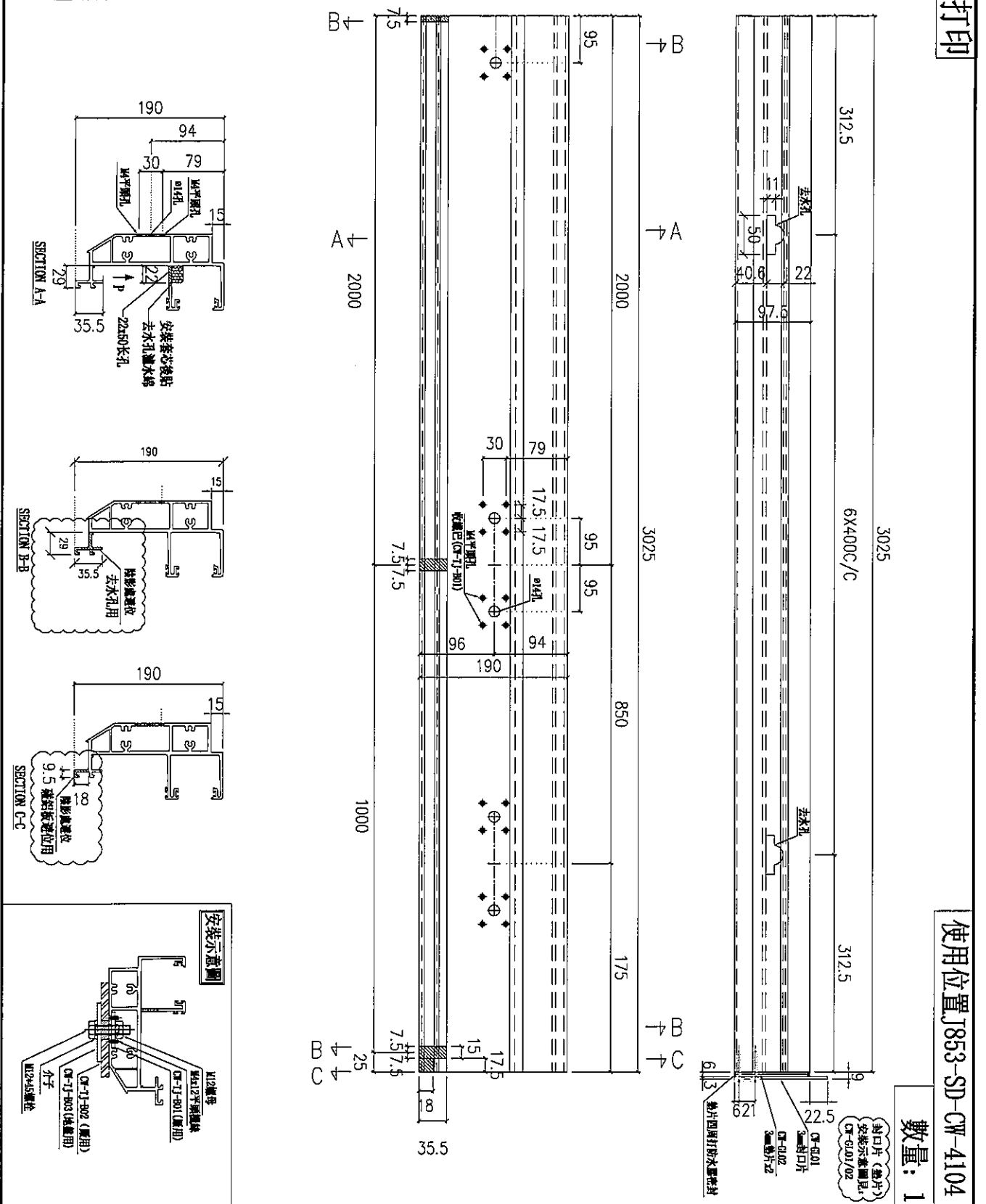

名稱	頂橫	制圖	陳敏聰	2022.03.15	修改	
材料	X85982	復核	謝永林	2022.03.21	日期	
顏色	JMQ213457(3 coatings)	批准			圖號	J853-T1-CW-S12b

美特鋁質有限公司
MIDI Aluminium Fabricator Ltd.

工程號 J853 地盤 延坪道

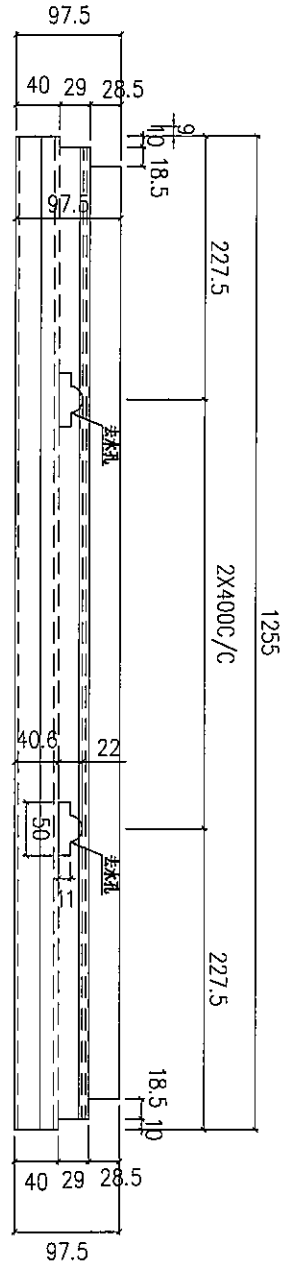
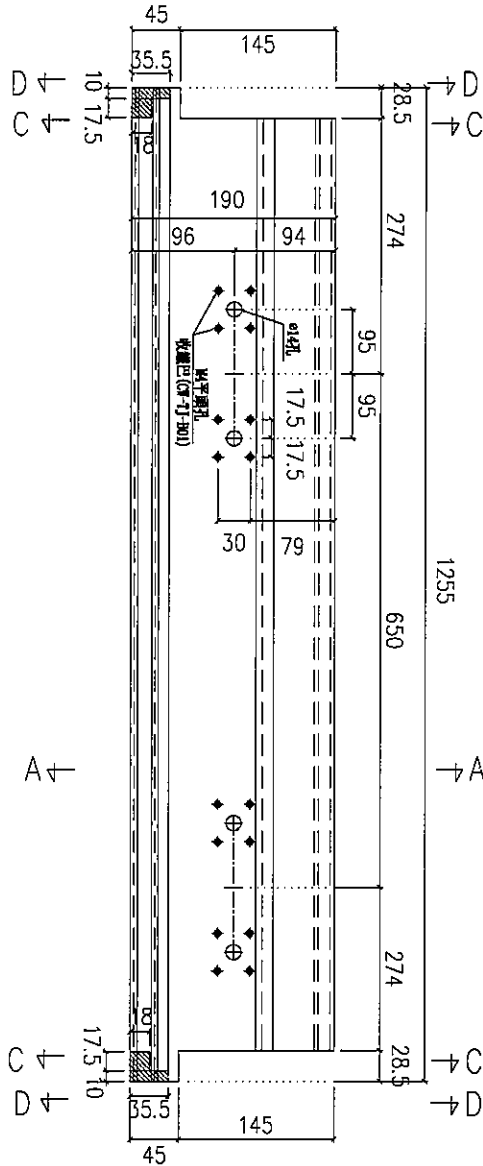
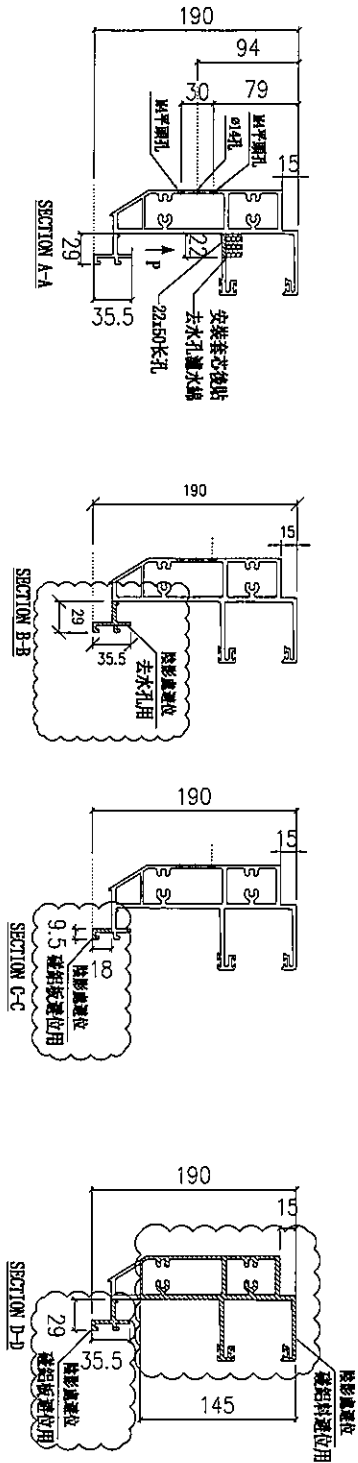

數量: 1

使用位置 J853-SD-CW-4104

名稱	頂橫	制圖	陳敏聰	2022.03.15	修改		
材料	X85982	復核	謝永林	2022.03.21	日期		
顏色	JMQ213457(3 coatings)	批准			圖號	J853-T1-CW-S14	

數量: 1

封口片 (黏片)
安裝示意圖見:
CW-D01/D2

封口片 (黏片)
安裝示意圖見:
CW-D01/D2

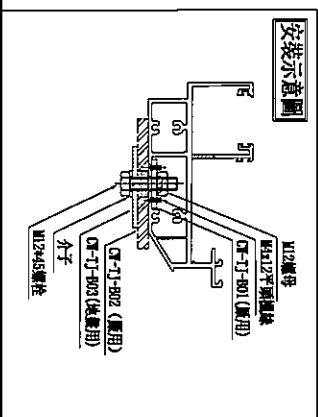
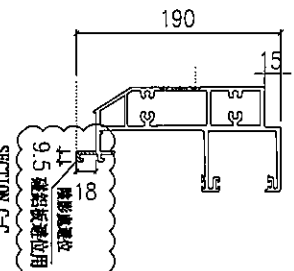
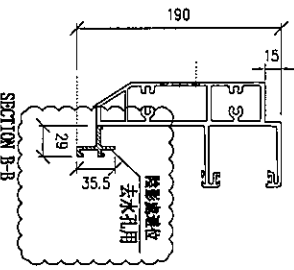
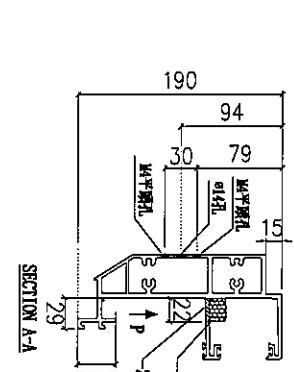
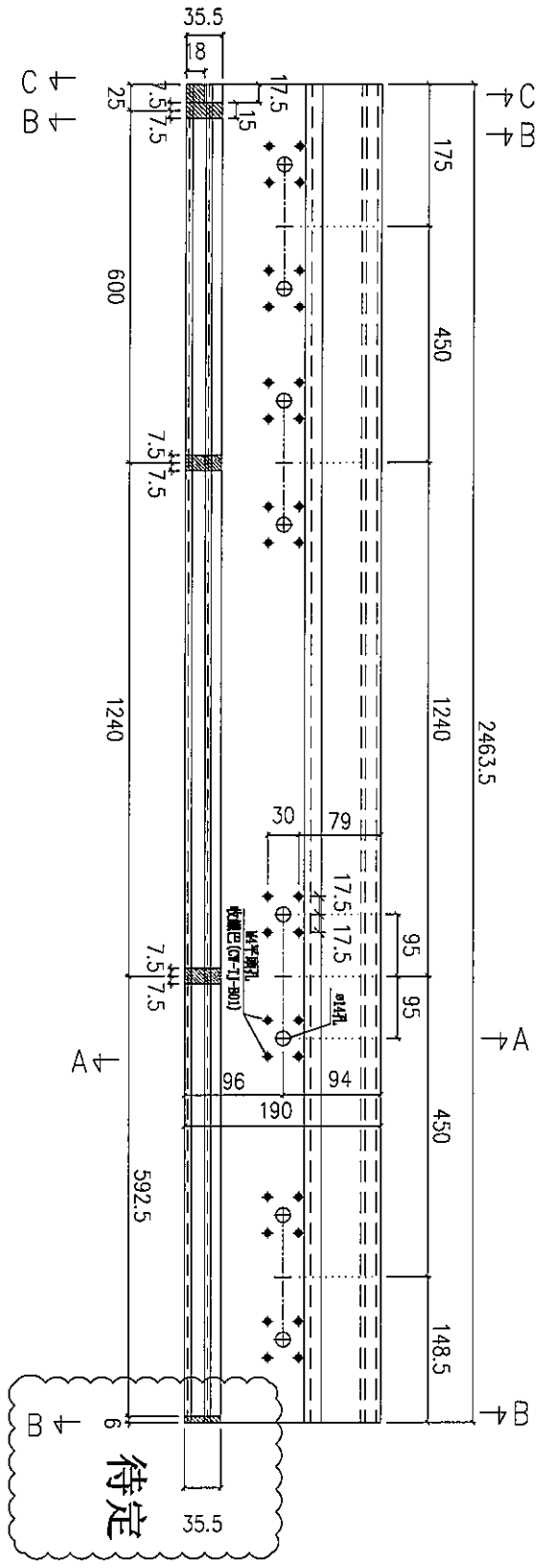
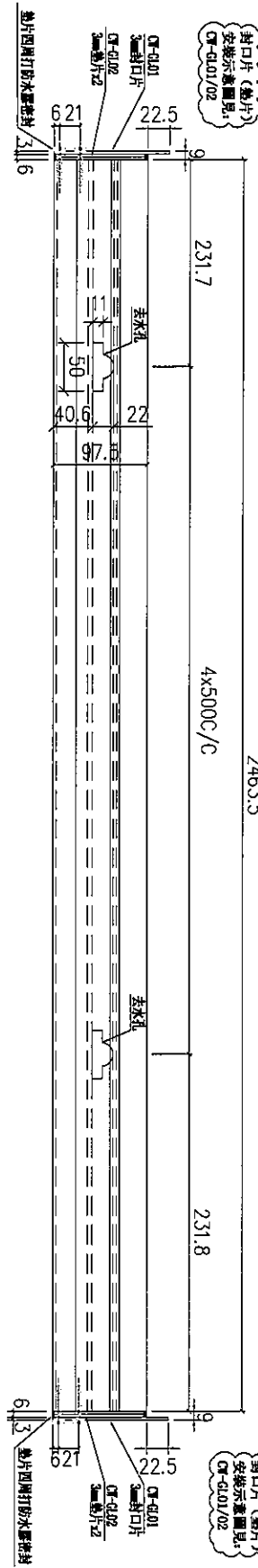

名稱	頂橫	制圖	陳敏聰	2022.03.15	修改
材料	X85982	復核	謝永林	2022.03.21	日期
顏色	JMQ213457(3 coatings)	批准			圖號
					J853-T1-CW-S15

美特鋁質有限公司
MIDI Aluminium Fabricator Ltd.

工程號 J853 地盤 延坪道

請用A3紙打印

使用位置 J853-SD-CW-4106

數量: 1

美特鋁質有限公司
MIDI Aluminium Fabricator Ltd.

工程號	J853	地盤	延坪道
-----	------	----	-----

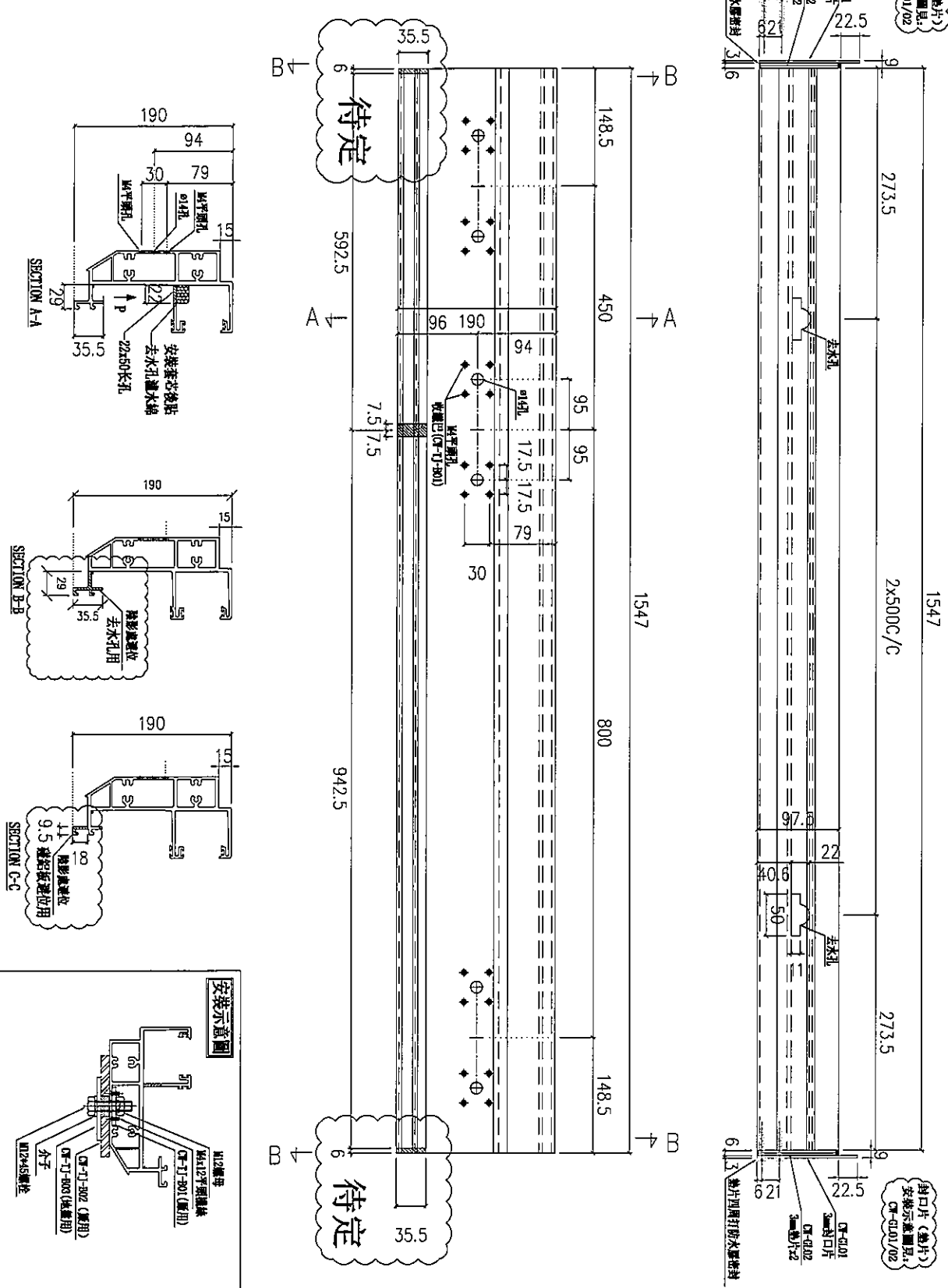

名稱	頂橫	制圖	陳敏聰	2022.03.15	修改
材料	X85982	復核	謝永林	2022.03.21	日期
顏色	JMQ213457(3 coatings)	批准			圖號 J853-T1-CW-S16

EG-DWG3

美特鋁質有限公司
 MIDI Aluminium Fabricator Ltd.

工程號	J853	地盤	延坪道
-----	------	----	-----

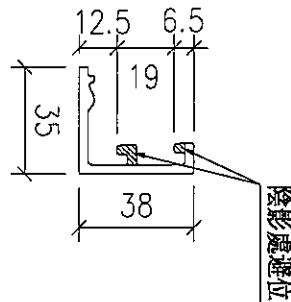
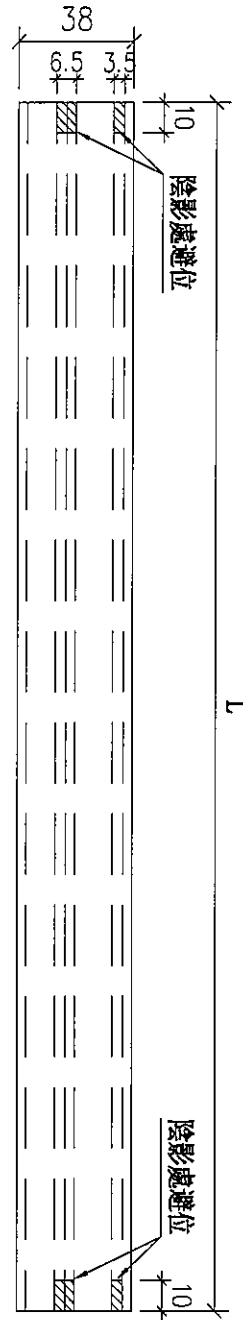

詳細數據請參考圖號
J853-T1-CW-KG01BM

名稱	玻璃扣蓋	制圖	陳敏聰	2022.03.16	修改		
材料	X85989	復核	謝永林	2022.03.21	日期		
顏色	JMQ213457(3 coatings)	批准			圖號	J853-T1-CW-KG01	

EG-DWG3

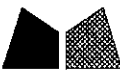
 美特鋁質有限公司 MIDI Aluminium Fabricator Ltd.							
工程號	J853	地盤	延坪道				
圖號	扣蓋長度 (L)	分格寬度	數量	使用位置			
J853-T1-CW-KG01a	1547.5	1562.5	1	J853-SD-CW-4101			
J853-T1-CW-KG01b	585	600	1	J853-SD-CW-4101			
J853-T1-CW-KG02a	585	600	1	J853-SD-CW-4101			
J853-T1-CW-KG02b	2097.5	2112.5	1	J853-SD-CW-4101			
J853-T1-CW-KG02c	585	600	1	J853-SD-CW-4101			
J853-T1-CW-KG03	585	600	1	J853-SD-CW-4101			
J853-T1-CW-KG04	585	600	1	J853-SD-CW-4101			
J853-T1-CW-KG05a	585	600	1	J853-SD-CW-4101			
J853-T1-CW-KG05b	1547.5	1562.5	1	J853-SD-CW-4101			
J853-T1-CW-KG06	1100	1115	1	J853-SD-CW-4102			
J853-T1-CW-KG09	1625	1640	1	J853-SD-CW-4103			
J853-T1-CW-KG10a	585	600	1	J853-SD-CW-4103			
J853-T1-CW-KG11	835	850	1	J853-SD-CW-4103			
J853-T1-CW-KG12a	985	1000	1	J853-SD-CW-4104			
J853-T1-CW-KG12b	1985	2000	1	J853-SD-CW-4104			
J853-T1-CW-KG12c	1985	2000	1	J853-SD-CW-4104			
J853-T1-CW-KG12d	985	1000	1	J853-SD-CW-4104			
J853-T1-CW-KG13a	947.5	962.5	1	J853-SD-CW-4104			
J853-T1-CW-KG13b	585	600	1	J853-SD-CW-4104			
J853-T1-CW-KG13c	585	600	1	J853-SD-CW-4104			
J853-T1-CW-KG13d	697.5	712.5	1	J853-SD-CW-4104			
J853-T1-CW-KG14	1235	1250		J853-SD-CW-4104			
J853-T1-CW-KG15a	585	600	1	J853-SD-CW-4106			
J853-T1-CW-KG15b	1225	1240	1	J853-SD-CW-4106			
J853-T1-CW-KG15c	585	600	1	J853-SD-CW-4106			
J853-T1-CW-KG16a	585	600	1	J853-SD-CW-4106			
J853-T1-CW-KG16b	935	950	1	J853-SD-CW-4106			
名稱	玻璃扣蓋數據表	制圖	陳敏聰	2022.03.16	修改		
材料	X85989	復核	謝永林	2022.03.21	日期		
顏色	JMQ213457(3 coatings)	批准			圖號	J853-T1-CW-KG01BM	

美特鋁質有限公司
MIDI Aluminium Fabricator Ltd.

工程號	J853	地盤	延坪道
-----	------	----	-----

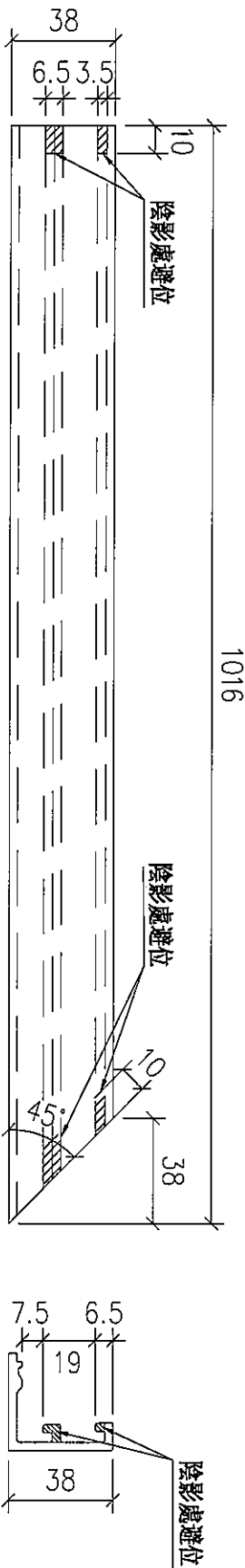

圖號	扣蓋長度 (L)	分格寬度	數量	使用位置
J853-T1-CW-KG07	1306	1315	1	J853-SD-CW-4103
J853-T1-CW-KG10b	1891	1900	1	J853-SD-CW-4103

名稱	玻璃扣蓋	制圖	陳敏聰	2022.03.16	修改		
材料	X85989	復核	謝永林	2022.03.21	日期		
顏色	JMQ213457(3 coatings)	批准			圖號	J853-T1-CW-KG07	

EG-DWG3

美特鋁質有限公司
 MIDI Aluminium Fabricator Ltd.

工程號 J853 地盤 延坪道

圖號	扣蓋長度 (L)	分格寬度	數量	使用位置
J853-T1-CW-KG08	1716	1725	1	J853-SD-CW-4103

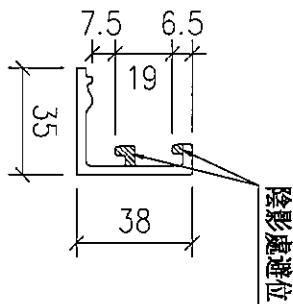
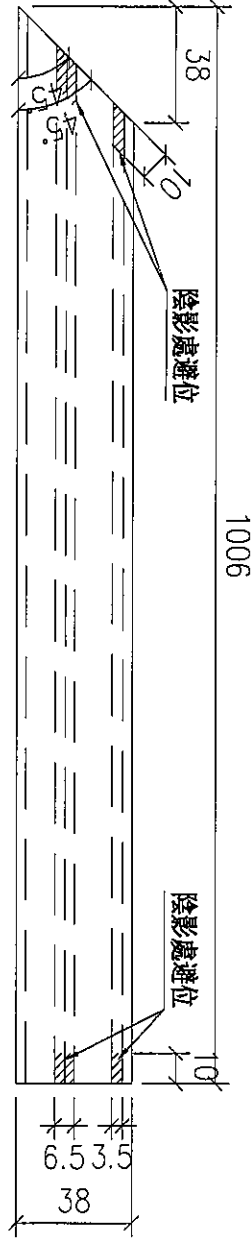

名稱	玻璃扣蓋	制圖	陳敏聰	2022.03.16	修改	
材料	X85989	復核	謝永林	2022.03.21	日期	
顏色	JMQ213457(3 coatings)	批准			圖號	J853-T1-CW-KG08

EG-DWG3

 美特鋁質有限公司 MIDI Aluminium Fabricator Ltd.					
工程號	J853	地盤	延坪道		
圖號	扣蓋長度 (L)	分格寬度	數量	使用位置	
J853-T2-CW-KG01	1185	1200	1	J853-SD-CW-4201	
J853-T2-CW-KG02	1185	1200	1	J853-SD-CW-4201	
J853-T2-CW-KG03a	585	600	1	J853-SD-CW-4201	
J853-T2-CW-KG03b	685	700	1	J853-SD-CW-4201	
J853-T2-CW-KG04a	1185	1200	1	J853-SD-CW-4202	
J853-T2-CW-KG04b	572.5	587.5	1	J853-SD-CW-4202	
J853-T2-CW-KG04c	585	600	1	J853-SD-CW-4202	
J853-T2-CW-KG04d	697.5	712.5	1	J853-SD-CW-4202	
J853-T2-CW-KG05	1172.5	1187.5	1	J853-SD-CW-4202	
J853-T2-CW-KG08	1185	1200	1	J853-SD-CW-4203	
J853-T2-CW-KG09a	897.5	912.5	1	J853-SD-CW-4204	
J853-T2-CW-KG09b	485	500	1	J853-SD-CW-4204	
J853-T2-CW-KG09c	847.5	862.5	1	J853-SD-CW-4204	
J853-T2-CW-KG09d	585	600	1	J853-SD-CW-4204	
J853-T2-CW-KG10a	702.5	717.5	1	J853-SD-CW-4204A	
J853-T2-CW-KG10b	935	950	1	J853-SD-CW-4204A	
J853-T2-CW-KG10c	1237.5	1252.5	1	J853-SD-CW-4204A	
J853-T2-CW-KG11a	1237.5	1252.5	1	J853-SD-CW-4204A	
J853-T2-CW-KG11b	935	950	1	J853-SD-CW-4204A	
J853-T2-CW-KG11c	702.5	717.5	1	J853-SD-CW-4204A	
J853-T2-CW-KG12a	585	600	1	J853-SD-CW-4205	
J853-T2-CW-KG12b	997.5	1012.5	1	J853-SD-CW-4205	
J853-T2-CW-KG12c	485	500	1	J853-SD-CW-4205	
J853-T2-CW-KG12d	897.5	912.5	1	J853-SD-CW-4205	
J853-T2-CW-KG13a	635	650	1	J853-SD-CW-4206	
J853-T2-CW-KG13b	922.5	937.5	1	J853-SD-CW-4206	
J853-T2-CW-KG13c	635	650	1	J853-SD-CW-4206	
J853-T2-CW-KG13d	1947.5	1962.5	1	J853-SD-CW-4206	
名稱	玻璃扣蓋數據表	制圖	陳敏聰	2022.03.15	修改
材料	X85989	復核	謝永林	2022.03.19	日期
顏色	JMQ213457(3 coatings)	批准			圖號 J853-T2-CW-KG01BM

D.D. REF :

請用A3紙打印

CLIENT : SHIMAO GROUP HOLDINGS LIMITED

ARCHITECT : WONG TUNG & PARTNERS LIMITED



MAIN CONTRACTOR : 協興建築有限公司 SHIP HING CONSTRUCTION CO. LTD

STRUCTURAL ENGINEER : C.M. WONG & ASSOCIATES LTD 黃志強建築工程師有限公司

FRAME CONSULTANT : MEINHARDT



NOTE: 1. ALL DIMENSIONS ARE IN MM. 2. ALL ELEVATIONS ARE VIEWED FROM OUTSIDE. 3. ALL DIMENSIONS TO BE VERIFIED ON SITE BEFORE FABRICATION.

LEGEND:

- 1. RETAIN MARK NO. 2. RETER SHEET NO. 1. FF.FL. - FINISHED FLOOR LEVEL. 2. S.F.L. - STRUCTURAL FLOOR LEVEL. 3. - - INVERTED DETAIL.

APPROVED DRAWING TO ARCH. CONTRACT NO. 09000

PROJECT : PROPOSED RESIDENTIAL DEVELOPMENT AT N.K.L.L. DS42 7/F, 8/F, 9/F, 10/F, 11/F, 12/F, 13/F, 14/F, 15/F, 16/F, 17/F, 18/F, 19/F, 20/F, 21/F, 22/F, 23/F, 24/F, 25/F, 26/F, 27/F, 28/F, 29/F, 30/F, 31/F, 32/F, 33/F, 34/F, 35/F, 36/F, 37/F, 38/F, 39/F, 40/F, 41/F, 42/F, 43/F, 44/F, 45/F, 46/F, 47/F, 48/F, 49/F, 50/F, 51/F, 52/F, 53/F, 54/F, 55/F, 56/F, 57/F, 58/F, 59/F, 60/F, 61/F, 62/F, 63/F, 64/F, 65/F, 66/F, 67/F, 68/F, 69/F, 70/F, 71/F, 72/F, 73/F, 74/F, 75/F, 76/F, 77/F, 78/F, 79/F, 80/F, 81/F, 82/F, 83/F, 84/F, 85/F, 86/F, 87/F, 88/F, 89/F, 90/F, 91/F, 92/F, 93/F, 94/F, 95/F, 96/F, 97/F, 98/F, 99/F, 100/F

TITLE : PART ELEVATION FOR CURTAIN WALL AT TOWER 2

DATE : 20-MAR-21 SCALE : 1:50 (A1) DRAWN BY : LHR CHECKED BY :

MECH. NO. : J-053 PROJECT : PROPOSED RESIDENTIAL DEVELOPMENT AT N.K.L.L. DS42 7/F, 8/F, 9/F, 10/F, 11/F, 12/F, 13/F, 14/F, 15/F, 16/F, 17/F, 18/F, 19/F, 20/F, 21/F, 22/F, 23/F, 24/F, 25/F, 26/F, 27/F, 28/F, 29/F, 30/F, 31/F, 32/F, 33/F, 34/F, 35/F, 36/F, 37/F, 38/F, 39/F, 40/F, 41/F, 42/F, 43/F, 44/F, 45/F, 46/F, 47/F, 48/F, 49/F, 50/F, 51/F, 52/F, 53/F, 54/F, 55/F, 56/F, 57/F, 58/F, 59/F, 60/F, 61/F, 62/F, 63/F, 64/F, 65/F, 66/F, 67/F, 68/F, 69/F, 70/F, 71/F, 72/F, 73/F, 74/F, 75/F, 76/F, 77/F, 78/F, 79/F, 80/F, 81/F, 82/F, 83/F, 84/F, 85/F, 86/F, 87/F, 88/F, 89/F, 90/F, 91/F, 92/F, 93/F, 94/F, 95/F, 96/F, 97/F, 98/F, 99/F, 100/F

REV. : A

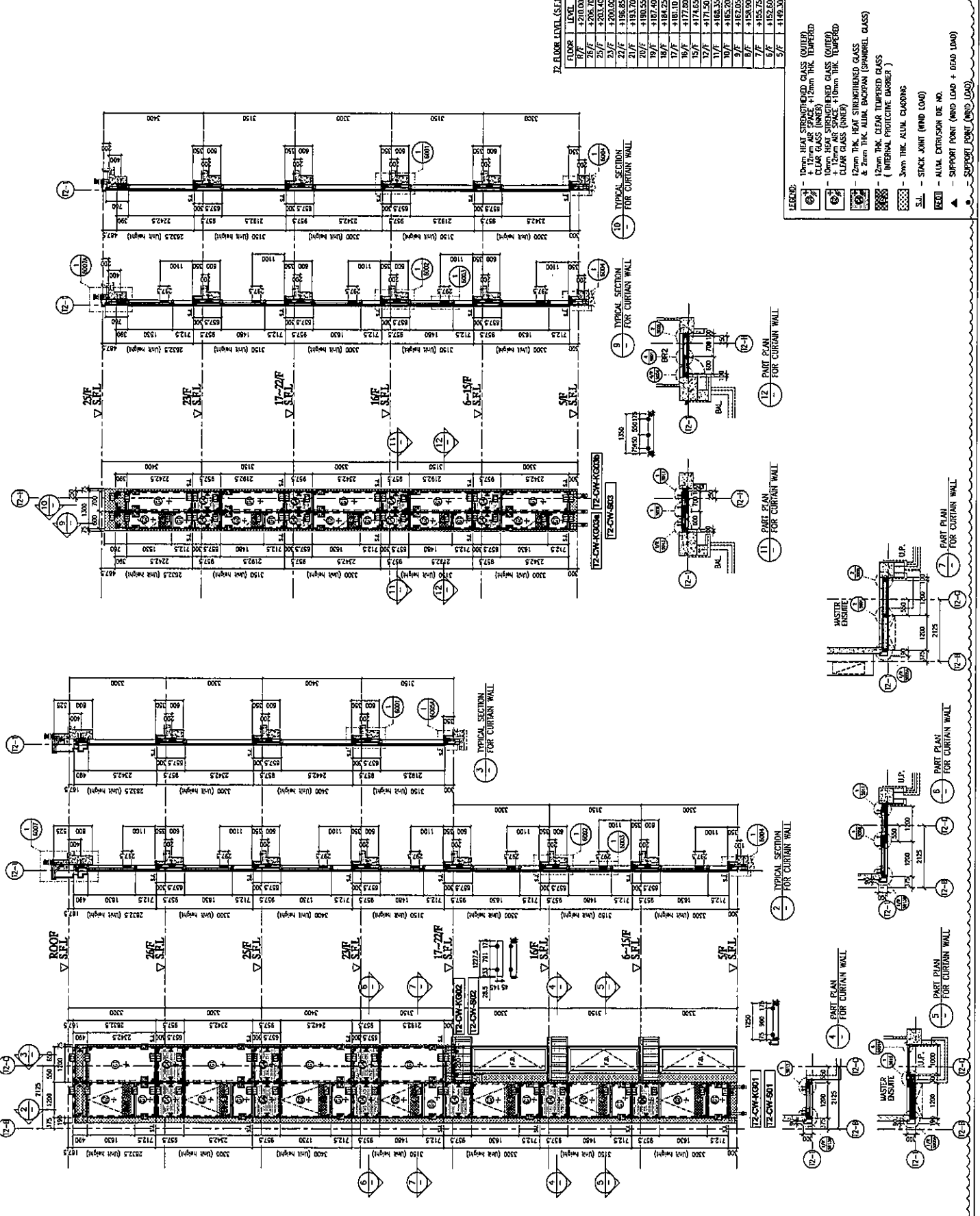

- LEGEND: 10mm HEAT STRENGTHENED GLASS (OUTER) + 12mm AIR SPACE + 12mm THK TEMPERED CLEAR GLASS (INNER) 10mm HEAT STRENGTHENED GLASS (OUTER) + 12mm AIR SPACE + 10mm THK TEMPERED CLEAR GLASS (INNER) 12mm THK HEAT STRENGTHENED GLASS + 2mm THK ALUM. BACKUP (SPANNEL GLASS) 3mm THK ALUM. CHAIRING S.L. - STACK JOINT (WIND LOAD) 1200 - ALUM. EXTENSION BE. NO. - SUPPORT POINT (WIND LOAD + DEAD LOAD) - SUPPORT POINT (WIND LOAD)

B.O. REF :

請用A3紙打印

CLIENT : SHIMAO GROUP HOLDINGS LIMITED

ARCHITECT : WONG TUNG & PARTNERS LIMITED



MAIN CONTRACTOR : 協興建築有限公司 HYP HING CONSTRUCTION CO LTD

STRUCTURAL DESIGNER : CMA C H WONG & ASSOCIATES LTD 黃志明建築工程師有限公司

FAÇADE CONSULTANT : MEINHARDT



NOTE : 1. ALL DIMENSIONS ARE IN MM. 2. ALL ELEVATIONS ARE VIEWED FROM OUTSIDE. 3. ALL DIMENSIONS TO BE CHECKED ON SITE BEFORE FABRICATION.

LEGEND :

- ① ACTUAL MARK NO.
- ② REFER SHEET NO.
- ③ F.F.L. - FINISHED FLOOR LEVEL.
- ④ S.F.L. - STRUCTURAL FLOOR LEVEL.
- ⑤ - REVERSED DETAIL.

1	DATE OF SHEET	ISSUED
2	DATE OF SHEET	REVISED

REV. NO. : J-853

PROJECT : PROPOSED RESIDENTIAL DEVELOPMENT AT N.L.L. 0942 101 PHUC HOA ROAD HO CHI MINH CITY

TITLE : PART ELEVATION FOR CURTAIN WALL AT TOWER 2

DWG. NO. : 26-MAR-21 SCALE : 1:60 (A1)

DRAWN BY : LHR CHECKED BY :

美特銘有限公司 MIDIDI ASSOCIATES ENGINEERS LTD. 1/F, 6-9, Sunny Industrial Centre, 1/F, 610 Chee Yee Road, Kampong Chhnang, Phnom Penh, Cambodia TEL: (855) 23727886

REV. : A

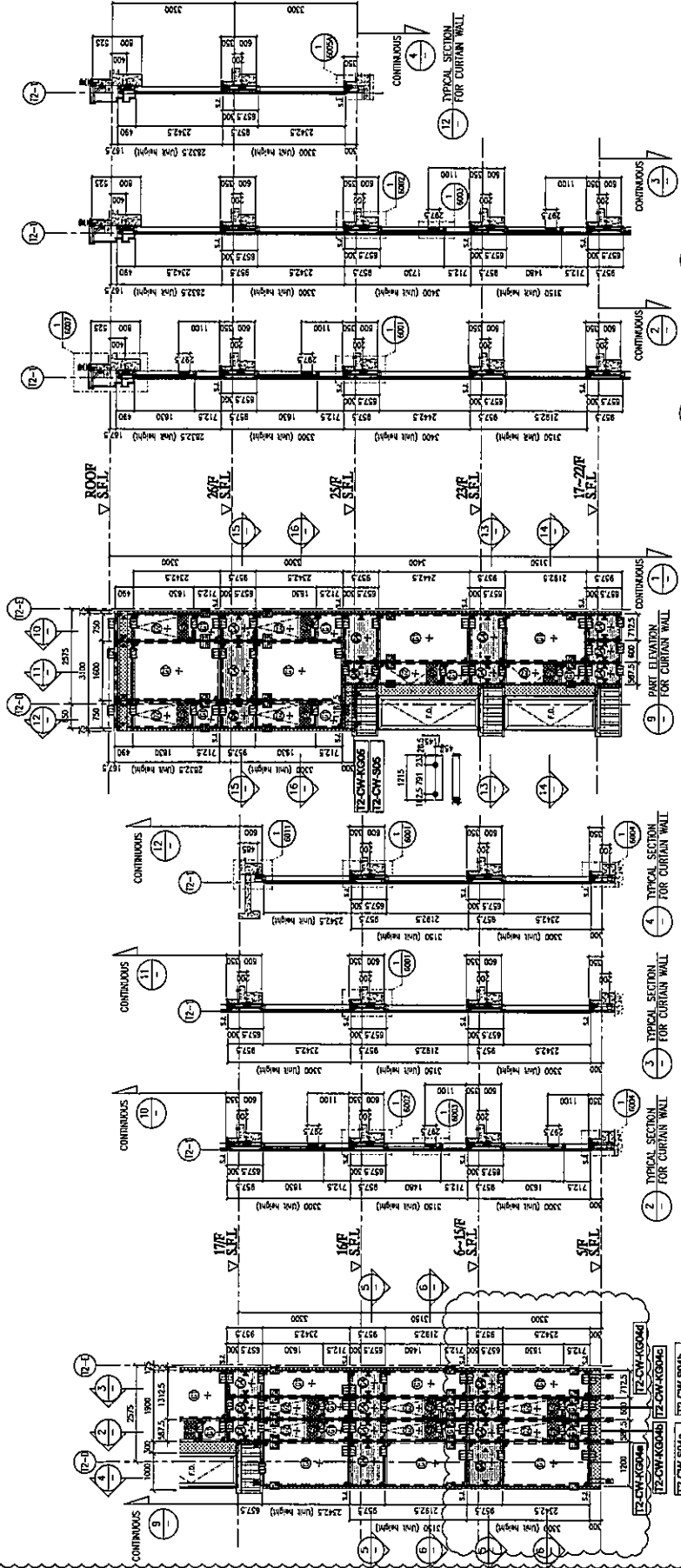

17 FLOOR LEVEL (S.F.L.)

FLOOR	LEVEL
17/F	+210.00
26/F	+206.70
25/F	+203.00
23/F	+200.00
22/F	+195.85
21/F	+193.70
20/F	+190.35
19/F	+187.40
18/F	+184.25
17/F	+181.10
16/F	+177.95
15/F	+174.80
14/F	+171.65
13/F	+168.50
12/F	+165.35
11/F	+162.20
10/F	+159.05
9/F	+155.90
8/F	+152.75
7/F	+149.60
5/F	+143.50

- LEGEND :
- ① 10mm HEAT STRENGTHENED GLASS (INNER)
 - ② 12mm AIR SPACE
 - ③ 12mm THK. TEMPERED CLEAR GLASS (INNER)
 - ④ 12mm AIR SPACE
 - ⑤ 12mm THK. TEMPERED CLEAR GLASS (INNER)
 - ⑥ 12mm THK. HEAT STRENGTHENED GLASS
 - ⑦ 12mm THK. CLEAR TEMPERED GLASS (INTERNAL PROTECTIVE BARREER)
 - ⑧ 3mm THK. ALUM. CLADDING
 - S.L. - STACK JOINT (WIND LOAD)
 - ALUM. EXTRUSION DE. NO.
 - SUPPORT POINT (WIND LOAD + 0500 LOAD)
 - SUPPORT POINT (WIND LOAD)

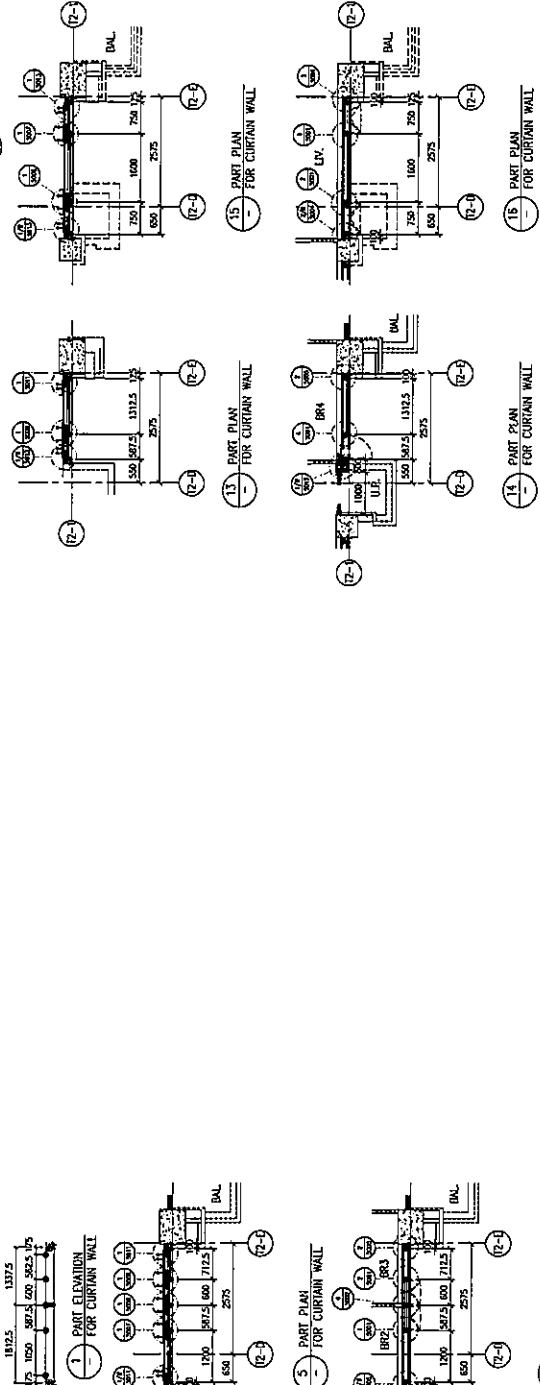

B.L. REF :

請用A3紙打印

CLIENT : SHIMAO GROUP HOLDINGS LIMITED

ARCHITECT : SHIMAO GROUP HOLDINGS LIMITED

STRUCTURAL CONTRACTOR : 德美建築有限公司
TOMMY HO & PARTNERS ARCHITECTS

STRUCTURAL ENGINEER : 德美建築有限公司
TOMMY HO & PARTNERS ARCHITECTS

FRAME CONSULTANT : MENHARDT

NOTE:

1. ALL DIMENSIONS ARE IN MM.
2. ALL ELEVATIONS ARE VIEWED FROM OUTSIDE.
3. ALL DIMENSIONS TO BE VERIFIED ON SITE.
4. ALL DIMENSIONS TO BE VERIFIED ON SITE.

LEGEND:

① - DETAIL MARK NO.

② - RETR. SHEET NO.

③ - F.F.L. --- FINISHED FLOOR LEVEL.

④ - S.F.L. --- STRUCTURAL FLOOR LEVEL.

⑤ - H. --- HANDED DEMOL.

PROJECT : PROPOSED RESIDENTIAL DEVELOPMENT AT 116-118 YIN PING ROAD, KOWLOON

JOB NO. : J-053

DATE : 26-MAR-21

SCALE : 1:60 (A1)

CHECKED BY : [Signature]

DATE : 26-MAR-21

SCALE : 1:60 (A1)

DATE : 26-MAR-21

SCALE : 1:60 (A1)

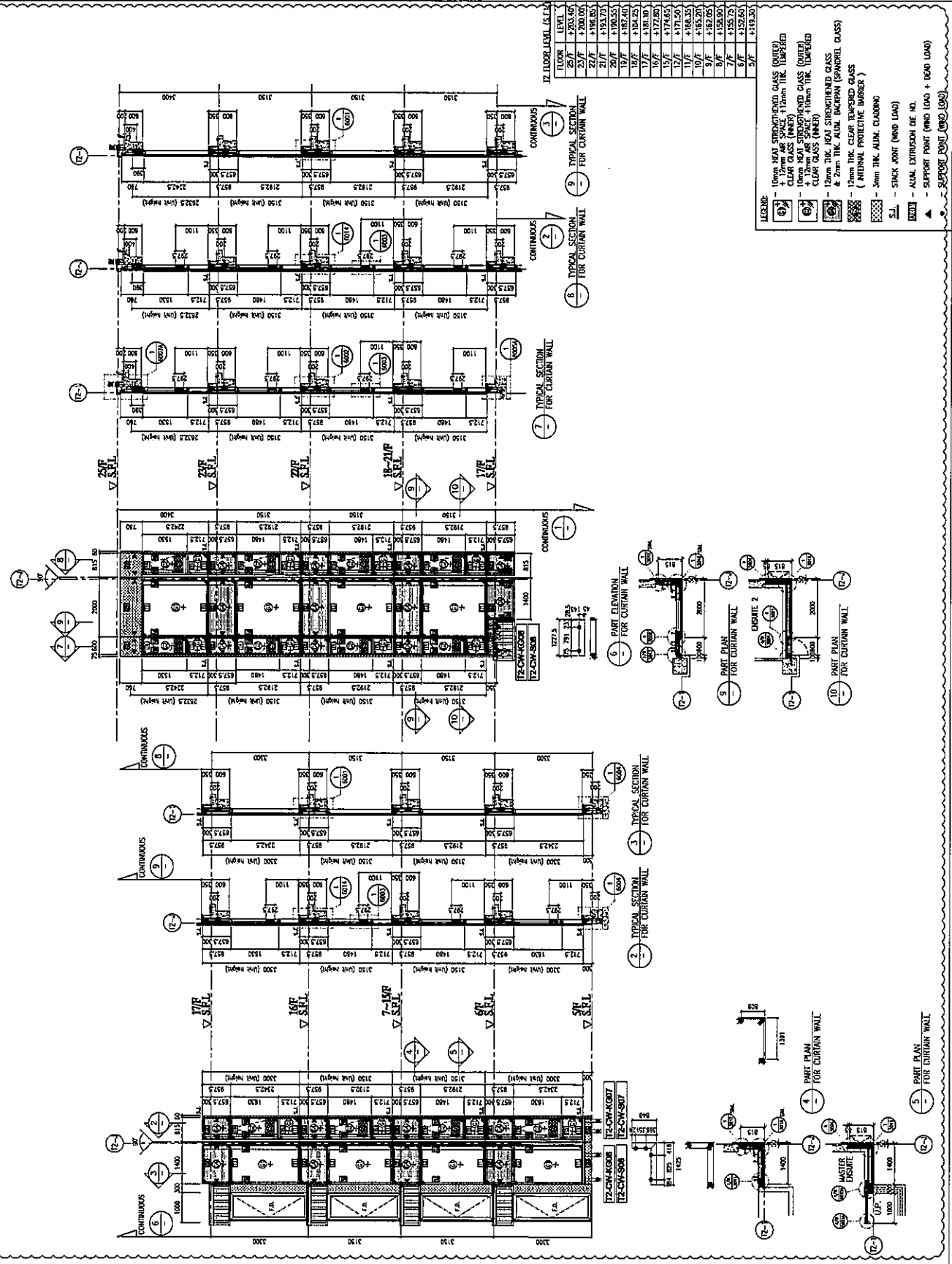

BD. REF :

請用A3紙打印

CLIENT :

SHIMAO GROUP HOLDINGS LIMITED

ARCHITECT : WONG TUNG & PARTNERS LIMITED



MAIN CONTRACTOR :

德興建築有限公司 HYP HING CONSTRUCTION CO. LTD

STRUCTURAL ENGINEER :

C M WONG & ASSOCIATES LTD 黃志明建築工程師有限公司

FAÇADE CONSULTANT :

MEINHARDT

NOTE: 1. ALL DIMENSIONS ARE IN MM. 2. ALL ELEVATIONS ARE VIEWED FROM OUTSIDE. 3. ALL DIMENSIONS TO BE WORKED ON SITE BEFORE FABRICATION.

LEGEND:

- 1. FILL --- FINISHED FLOOR LEVEL. 2. S.L. --- STRUCTURAL FLOOR LEVEL. 3. (R) --- REVERSED DETAIL.

FLOOR LEVEL (S.L.)

Table with 2 columns: FLOOR LEVEL, S.L. Values range from 2100.00 to 419.30.

LEGEND:

- 10mm HEAT STRENGTHENED GLASS (OUTER) + 12mm AIR SPACE + 12mm THK. TEMPERED CLEAR GLASS (INNER) ...

- S.L. --- STACK JOINT (WIND LOAD) ALUM. EXPOSURE (WIND LOAD) ...

DATE: 26-MAR-21 SCALE: 1:50 (A1) DRAWN BY: LHR CHECKED BY: ...

MEINHARDT 美特銳有限公司 Unit 6-B, Sunny Industrial Centre, 1/F ...

JOB NO.: J-853 PROJECT: PROPOSED RESIDENTIAL DEVELOPMENT AT N.K.L.L. 5542 ...

TITLE: PART ELEVATION FOR CURTAIN WALL AT TOWER 2

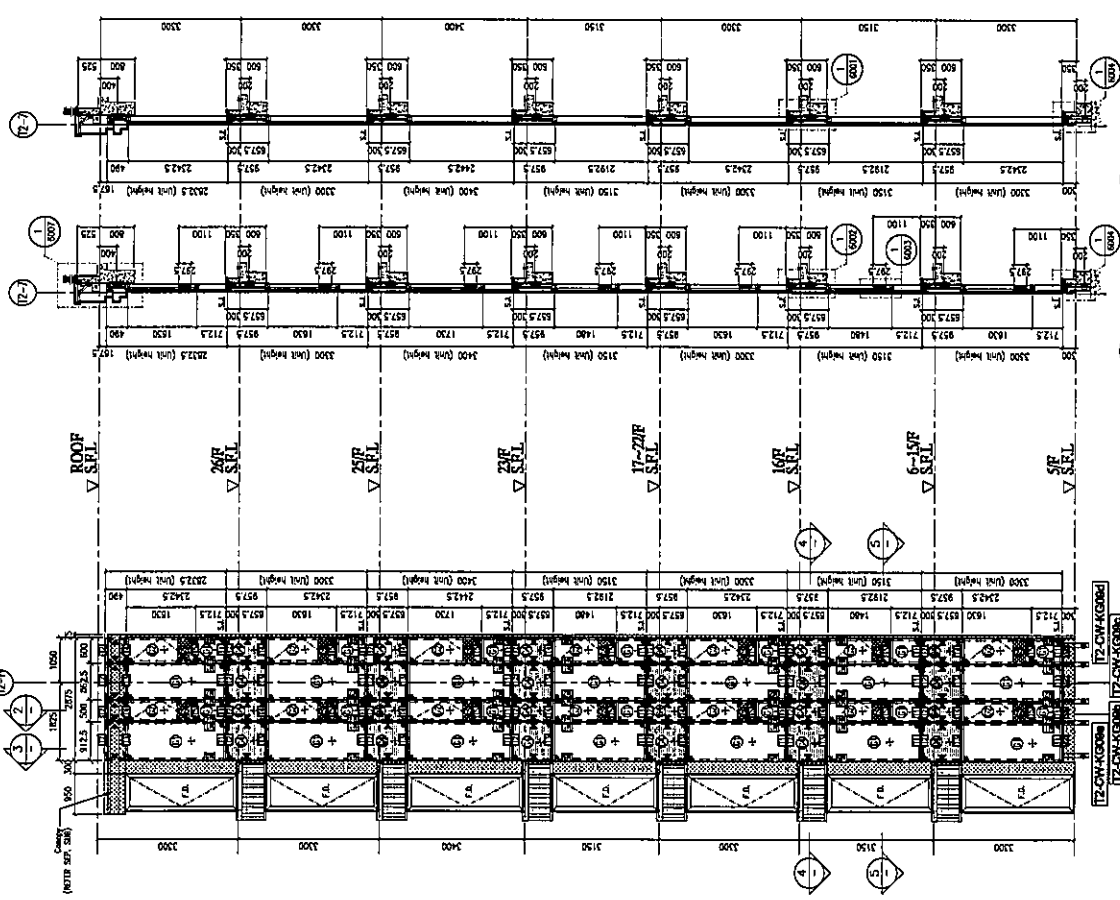

1 TYPICAL SECTION FOR CURTAIN WALL

2 TYPICAL SECTION FOR CURTAIN WALL

3 PART ELEVATION FOR CURTAIN WALL

4 PART ELEVATION FOR CURTAIN WALL

5 PART PLAN FOR CURTAIN WALL

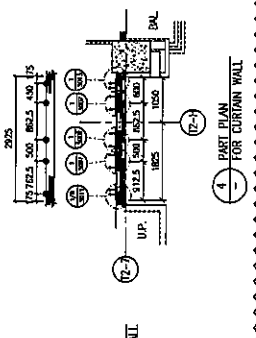
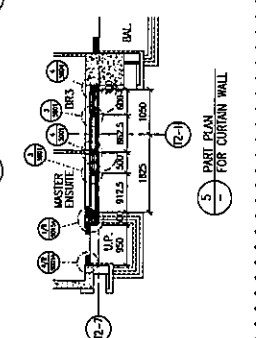

REV: A

B.D. REF :

請用A3紙打印

CLIENT : SHIMAO GROUP HOLDINGS LIMITED

ARCHITECT : YONG TUNG & PARTNERS LIMITED

MAIN CONTRACTOR : 協興建築有限公司
HP HING CONSTRUCTION CO. LTD

STRUCTURAL ENGINEER : C H WONG & ASSOCIATES LTD
黃志輝建築工程師有限公司

FAÇADE CONSULTANT : MEINHARDT

NOTE :

1. ALL DIMENSIONS ARE IN MM.
2. ALL ELEVATIONS ARE VIEWED FROM OUTSIDE.
3. ALL DIMENSIONS TO BE VERIFIED ON SITE BEFORE FABRICATION.

LEGEND :

- 1. CIRCULAR MARK NO. REFER SHEET NO.
- 2. F.F.L. -- FINISHED FLOOR LEVEL.
- 3. S.F.L. -- STRUCTURAL FLOOR LEVEL.
- 4. -- REVERSED OCIAL

FLOOR	LEVEL
ROOF	+210.00
26/F	+206.70
25/F	+203.40
24/F	+200.00
23/F	+196.65
22/F	+193.30
21/F	+189.95
20/F	+186.60
19/F	+183.25
18/F	+179.90
17/F	+176.55
16/F	+173.20
15/F	+169.85
14/F	+166.50
13/F	+163.15
12/F	+159.80
11/F	+156.45
10/F	+153.10
9/F	+149.75
8/F	+146.40
7/F	+143.05
6/F	+139.70
5/F	+136.35

JOB NO. : J-853

PROJECT : PROPOSED RESIDENTIAL DEVELOPMENT AT N.K.L.L. 6542
YIN PING ROAD
KOWLOON

TITLE : PART ELEVATION FOR CURTAIN WALL AT TOWER 2

DATE : 22-OCT-21 SCALE : 1:60 (A1)

DRAWN BY : LHR CHECKED BY :

美特銳有限公司
MIDI INTERNATIONAL VENTURES LTD.
Unit 8-9, Sunny Industrial Centre, 1/T
142, 143 & 144 Wing Lok Street, Mong Kok, Kowloon
TEL: (852) 27271866
FAX: (852) 27271866

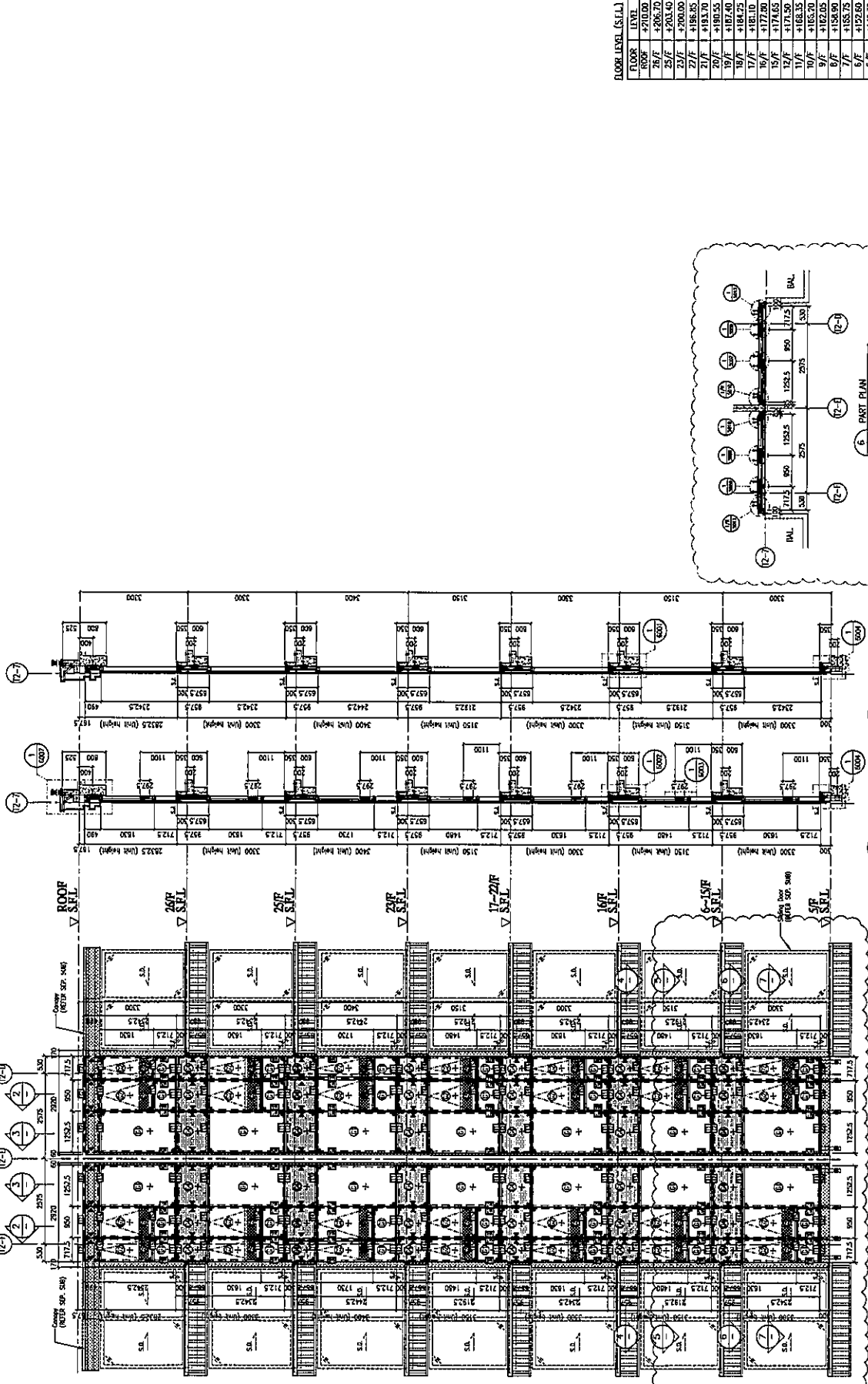

LEGEND :

- 10mm HEAT STRENGTHENED GLASS (OUTER) + 17mm AIR SPACE + 12mm THK. TEMPERED CLEAR GLASS (INNER)
- 12mm HEAT STRENGTHENED GLASS (OUTER) + 12mm AIR SPACE + 10mm THK. TEMPERED CLEAR GLASS (INNER)
- 12mm THK. HEAT STRENGTHENED GLASS & 2mm THK. ALUM. INSULATION (SPANDREL GLASS) (INTERNAL PROTECTIVE BARRIER)
- 3mm THK. ALUM. CLADDING
- S.S. -- STACK JOINT (WIND LOAD)
- ALUM. EXTRUSION BE. HO.
- SUPPORT POINT (WIND LOAD + DEAD LOAD)
- SUPPORT POINT (WIND LOAD)

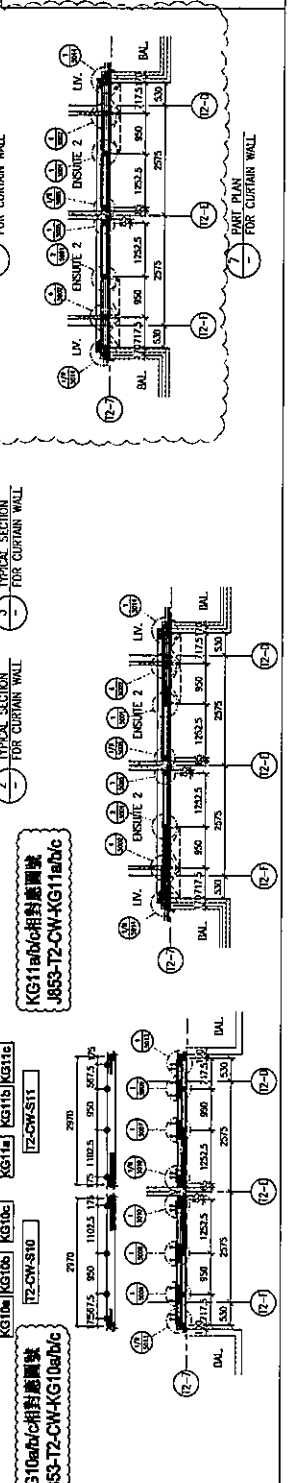

B.D. REF :

請用A3紙打印

CLIENT : SHIMAO GROUP HOLDINGS LIMITED

ARCHITECT : WONG TUNG & PARTNERS LIMITED

MAIN CONTRACTOR : 美特銳有限公司
MIDI AP HING CONSTRUCTION CO LTD

STRUCTURAL ENGINEER : CH WONG & ASSOCIATES LTD
齊志勇建築工程師有限公司

FAÇADE CONSULTANT : MEINHARDT

MODE :
1. ALL DIMENSIONS ARE IN MM.
2. ALL ELEVATIONS ARE VIEWED FROM OUTSIDE.
3. ALL DIMENSIONS TO BE VERIFIED ON SITE BEFORE FABRICATION.

LEGEND:
① DETAIL MARK NO.
② REFER SHEET NO.

1. F.F.L. — FINISHED FLOOR LEVEL.
2. S.F.L. — STRUCTURAL FLOOR LEVEL.
3. — REVERSED DETAIL.

JOB NO. : J-853

PROJECT : PROPOSED RESIDENTIAL DEVELOPMENT AT N.K.L.L. 6542
YIN PING ROAD
KOWLOON.

TITLE : PART ELEVATION FOR CURTAIN WALL AT TOWER 2

DATE : 26-MAR-23 SCALE : 1:50 (A1)

DRAWN BY : LHR CHECKED BY :

美特銳有限公司
MIDI AP HING CONSTRUCTION CO. LTD
Units 6-8, Sunny Industrial Centre, 1/F
142, HING YIP STREET, KOWLOON
TEL: (852) 27272668
FAX: (852) 27272668

DRG NO. : MS3-SID-09-4205 REF. : A

FLOOR LEVEL	LEVEL
ROOF	+210.00
20/F	+206.75
19/F	+203.50
18/F	+200.25
17/F	+197.00
16/F	+193.75
15/F	+190.50
14/F	+187.25
13/F	+184.00
12/F	+180.75
11/F	+177.50
10/F	+174.25
9/F	+171.00
8/F	+167.75
7/F	+164.50
6/F	+161.25
5/F	+158.00

LEGEND:
 ① 10mm HEAT STRENGTHENED GLASS (OUTER)
 + 12mm AIR SPACE (INNER)
 + 12mm HEAT STRENGTHENED GLASS (OUTER)
 + 12mm AIR SPACE (INNER)
 + 12mm HEAT STRENGTHENED GLASS (OUTER)
 + 12mm AIR SPACE (INNER)
 + 12mm HEAT STRENGTHENED GLASS (OUTER)
 + 2mm THK. ALUM. BACKUP (SPANDREL GLASS)
 + 12mm THK. CLEAR TEMPERED GLASS (INTERNAL PROTECTIVE BARRIER)
 + 3mm THK. ALUM. CLADDING

S.L. — STACK JOINT (WIND LOAD)
 B.C. — ALUM. EXTRUSION (WIND LOAD)
 ▲ — SUPPORT POINT (WIND LOAD + DEAD LOAD)
 ● — SUPPORT POINT (WIND LOAD)

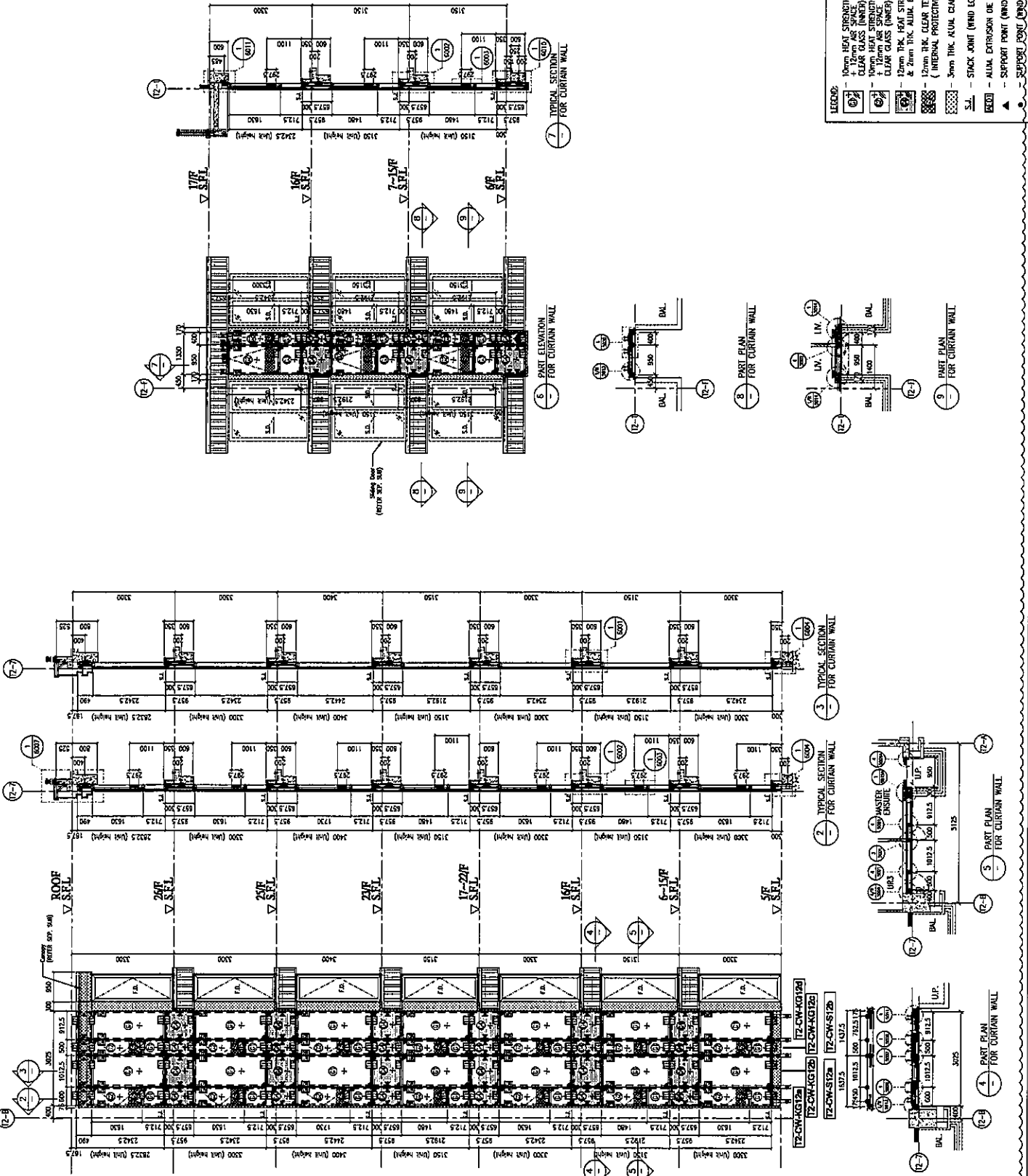

B.D. REF :

請用A3紙打印

CLIENT : SHIMAO GROUP HOLDINGS LIMITED

ARCHITECT : HOANG THING & PARTNERS LIMITED



MAIN CONTRACTOR : 德昌建築有限公司 HING CONSTRUCTION CO. LTD

STRUCTURAL ENGINEER :

CH WONG & ASSOCIATES LTD 齊志明建築工程顧問有限公司

FAÇADE CONSULTANT :



NOTE: 1. ALL DIMENSIONS ARE IN MM. 2. ALL DIMENSIONS ARE VIEWED FROM OUTSIDE. 3. ALL DIMENSIONS TO BE VERIFIED ON SITE BEFORE FABRICATION.

LEGEND:

- 1. DETAIL MARK NO. 2. REFER SHEET NO. 1. F.F.L. - FINISHED FLOOR LEVEL. 2. S.F.L. - STRUCTURAL FLOOR LEVEL. 3. (R) - REVERSED DETAIL.

Table with 2 columns: FLOOR LEVEL (S.F.L.), FLOOR LEVEL. Rows: ROOF 270.00, 26/F 2208.70, 25/F 2203.40

PROJECT : PROPOSED RESIDENTIAL DEVELOPMENT AT N.K.L.L. 6542 YUN PING ROAD KOWLOON. TITLE : PART ELEVATION FOR CURTAIN WALL AT TOWER 2. DATE : 05-OCT-21. SCALE : 1:60 (A1). DOWN BY : LHR. CHECKED BY : 美特銘有限公司 MIDY Architecture Associates Ltd. 11th & 5, Sunny Industrial Centre, 1/F. Unit C, 1st Floor, Kowloon. TEL: 34258211-4. Fax: (852)27272666. DWG NO. : JMS3-SD-CW-4206. REV. : A

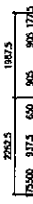
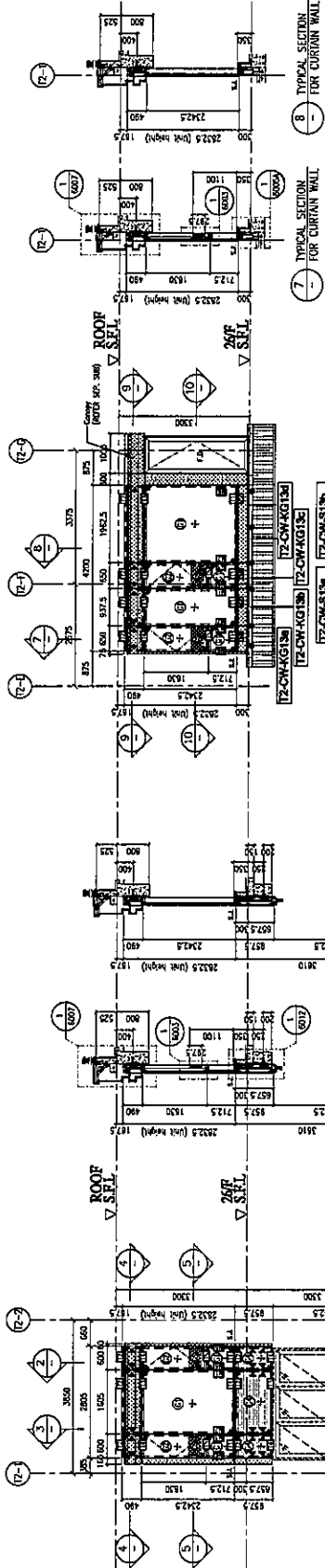

PART ELEVATION FOR CURTAIN WALL

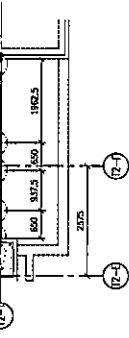

PART PLAN FOR CURTAIN WALL

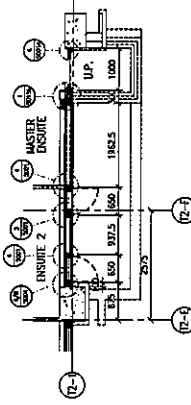

PART PLAN FOR CURTAIN WALL

- LEGEND: 10mm HEAT STRENGTHENED GLASS (OUTER) + 12mm AIR SPACE + 12mm THK. TEMPERED CLEAR GLASS (INNER). 10mm HEAT STRENGTHENED GLASS (OUTER) + 12mm AIR SPACE + 10mm THK. TEMPERED CLEAR GLASS (INNER). 12mm THK. HEAT STRENGTHENED GLASS & 2mm THK. ALUM. BACKPAN (SPANDREL GLASS). 12mm THK. CLEAR TEMPERED GLASS (INTERNAL PROTECTIVE BARRIER). 3mm THK. ALUM. CLADDING. S.L. - STACK JOINT (WIND LOAD). (R) - ALUM. EXTRUSION DE. NO. ▲ - SUPPORT POINT (WIND LOAD + DEAD LOAD) ● - SUPPORT POINT (WIND LOAD)

EG-DWG3

美特鋁質有限公司
 MIDI Aluminium Fabricator Ltd.

工程號	J853	地盤	延坪道
-----	------	----	-----

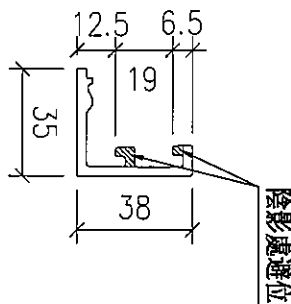
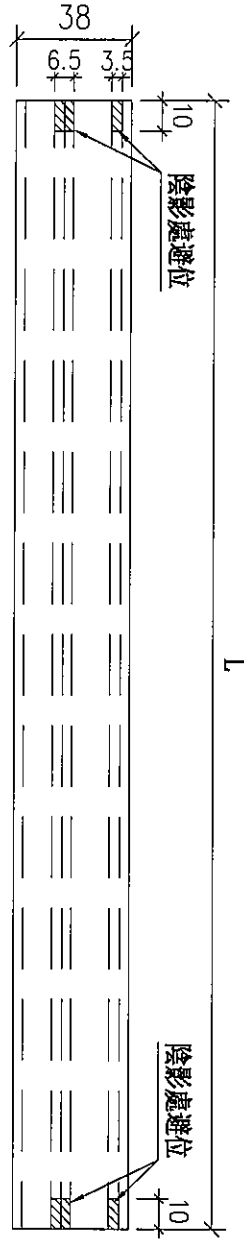

詳細數據請參考圖號
J853-T2-CW-KG01BM

名稱	玻璃扣蓋	制圖	陳敏聰	2022.03.15	修改		
材料	X85989	復核	謝永林	2022.03.19	日期		
顏色	JMQ213457(3 cootinas)	批准			圖號	J853-T2-CW-KG01	



美特鋁質有限公司
MIDI Aluminium Fabricator Ltd.

工程號 J853 地盤 延坪道

請用A3紙打印

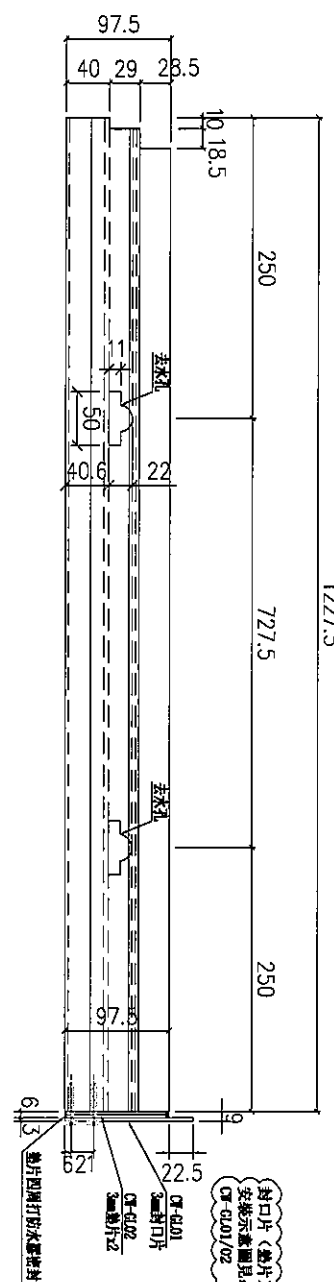
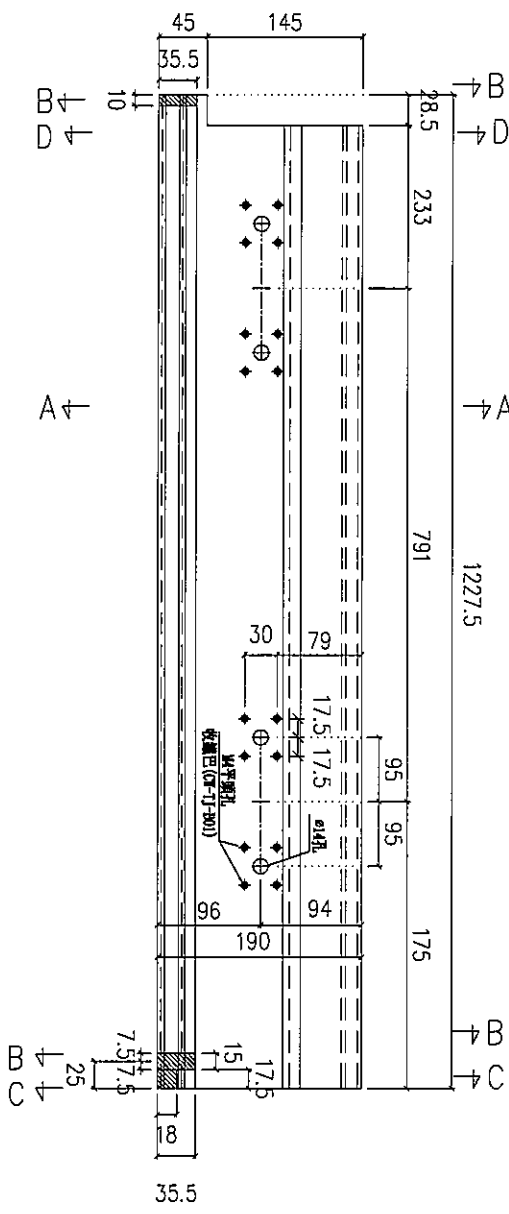
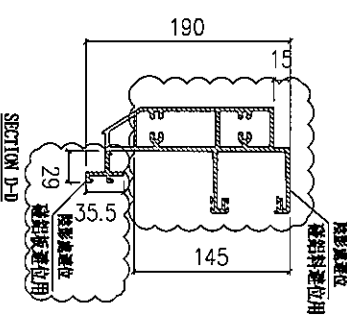
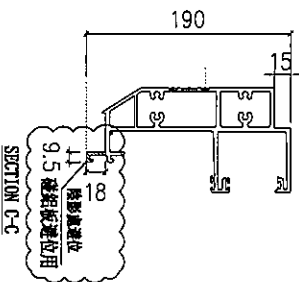
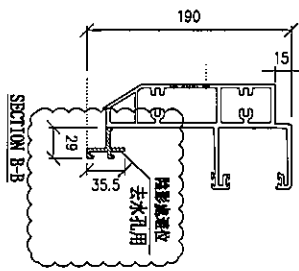
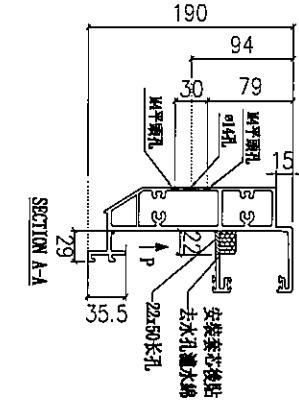

數量: 1

使用位置 J853-SD-CW-4201

名稱	頂橫	制圖	陳敏聰	2022.03.16	修改
材料	X85982	復核	謝永林	2022.03.19	日期
顏色	JMQ213457(3 coatings)	批准			圖號 J853-T2-CW-S02

美特鋁質有限公司
MIDI Aluminium Fabricator Ltd.

工程號 J-853 地盤 延坪道

請用A3紙打印

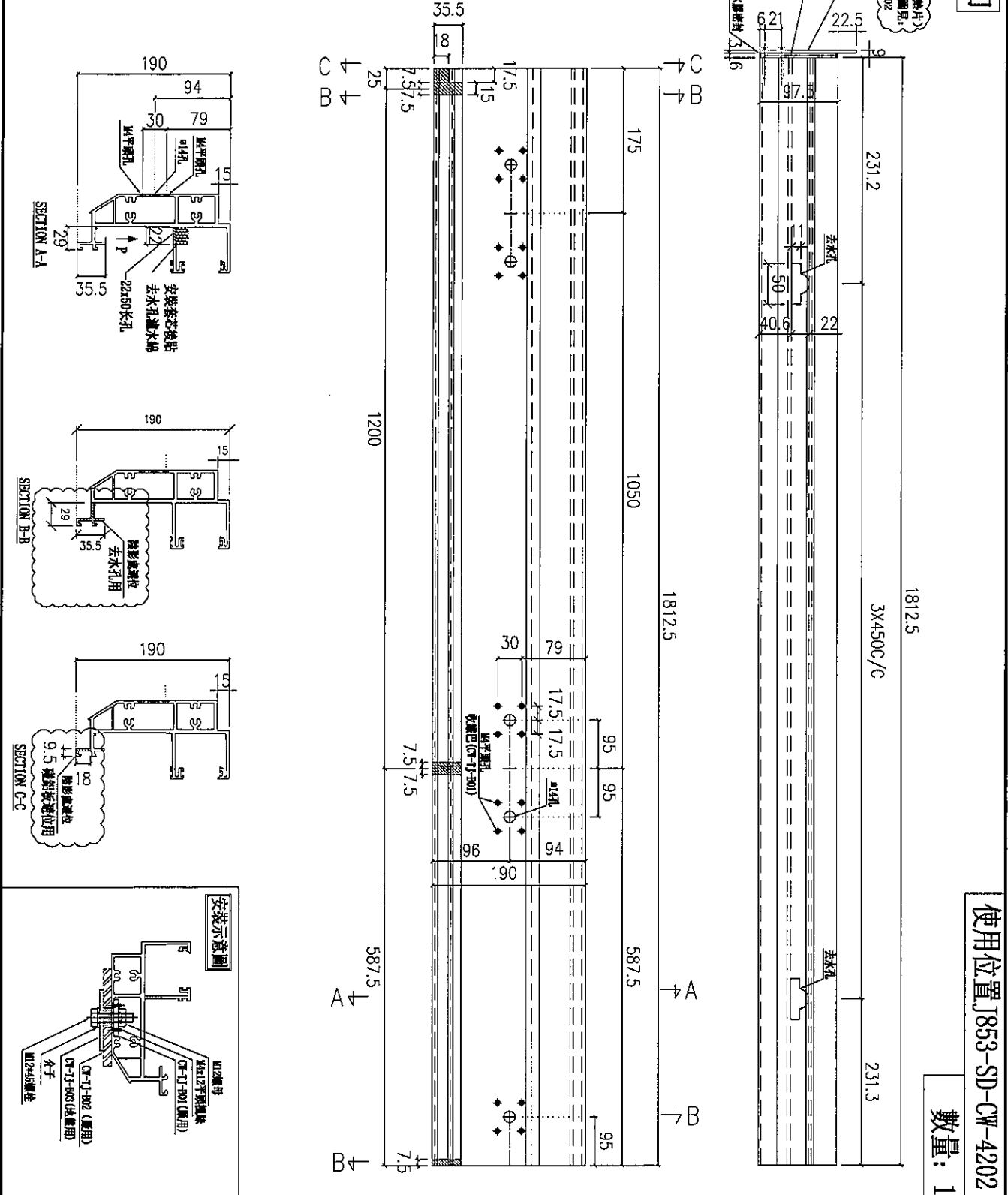

數量: 1

使用位置 J853-SD-CW-4202

名稱	頂橫	制圖	陳敏聰	2022.03.16	修改
材料	X85982	復核	謝永林	2022.03.19	日期
顏色	JMQ213457(3 coatings)	批准			圖號 J853-T2-CW-S04a

請用A3紙打印

使用位置 J853-SD-CW-4203

數量: 1

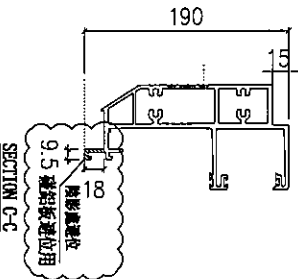
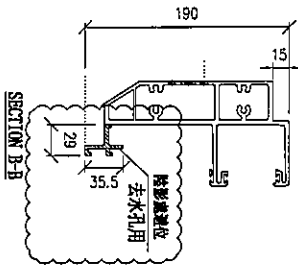
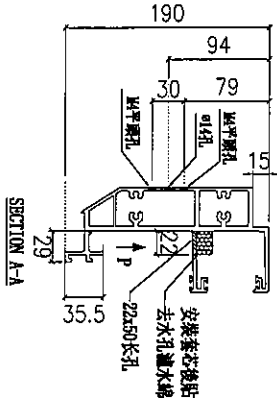
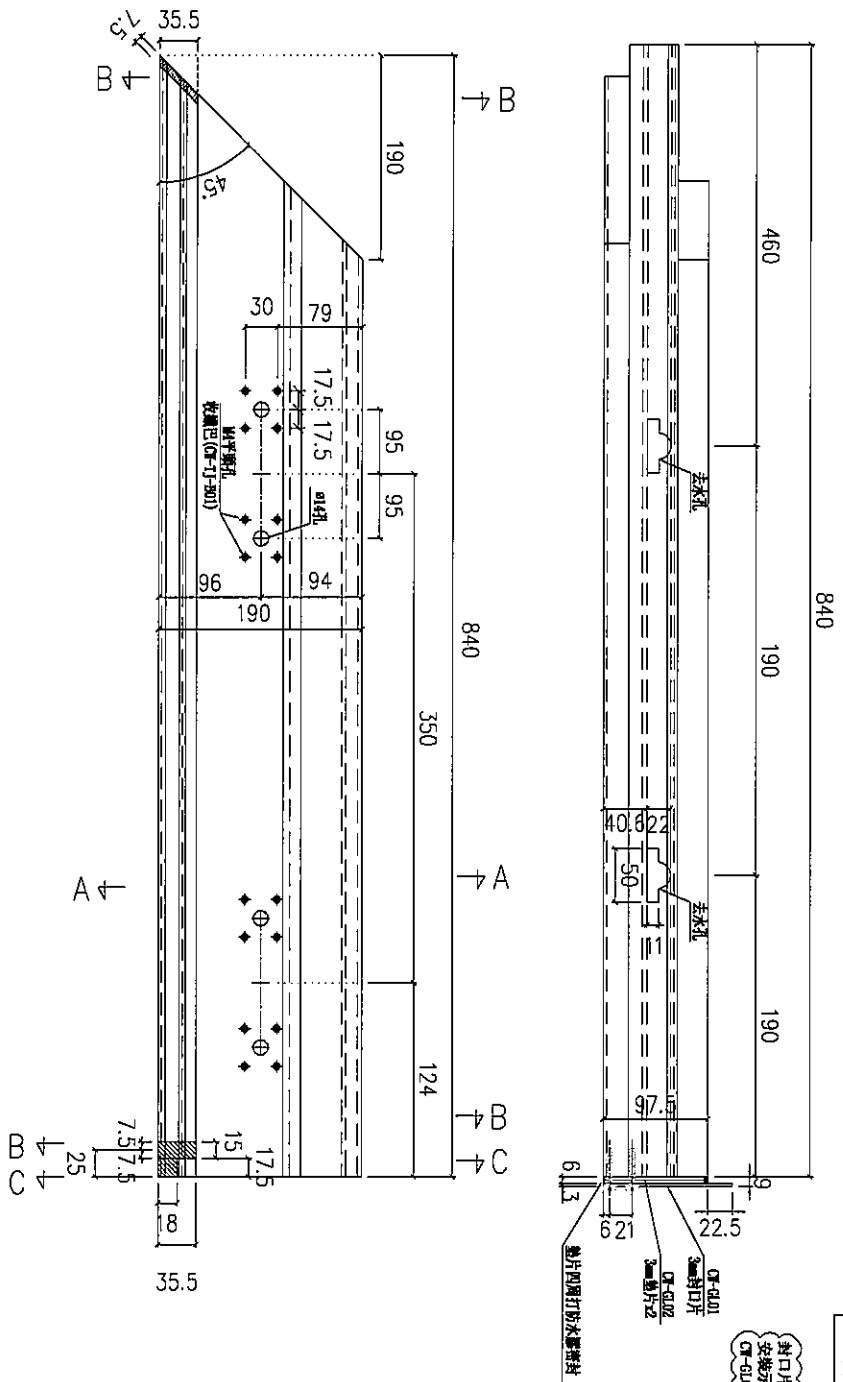

安裝示意圖

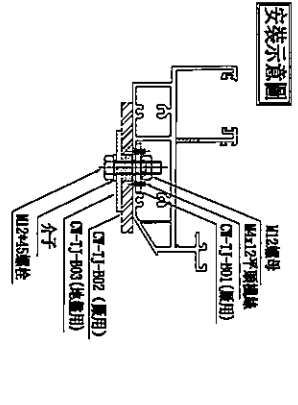

名稱	頂橫	制圖	陳敏聰	2022.03.16	修改	
材料	X85982	復核	謝永林	2022.03.19	日期	
顏色	JMQ213457(3 coatings)	批准			圖號	J853-T2-CW-S07

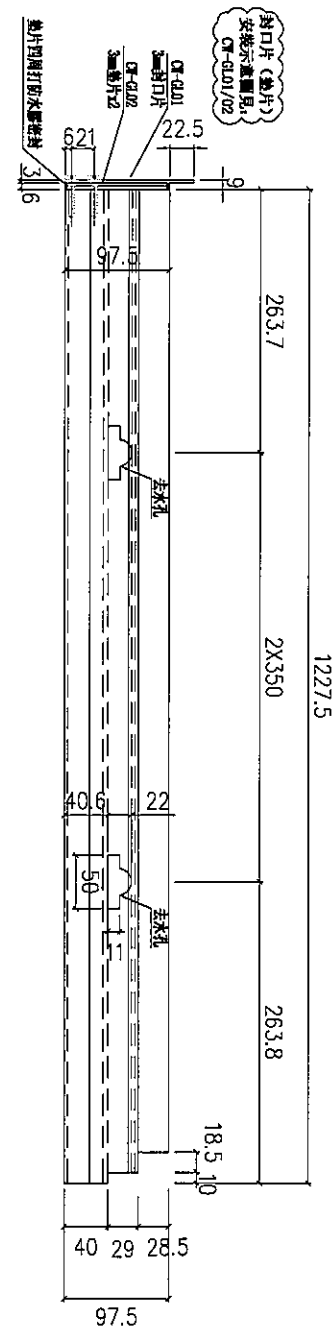
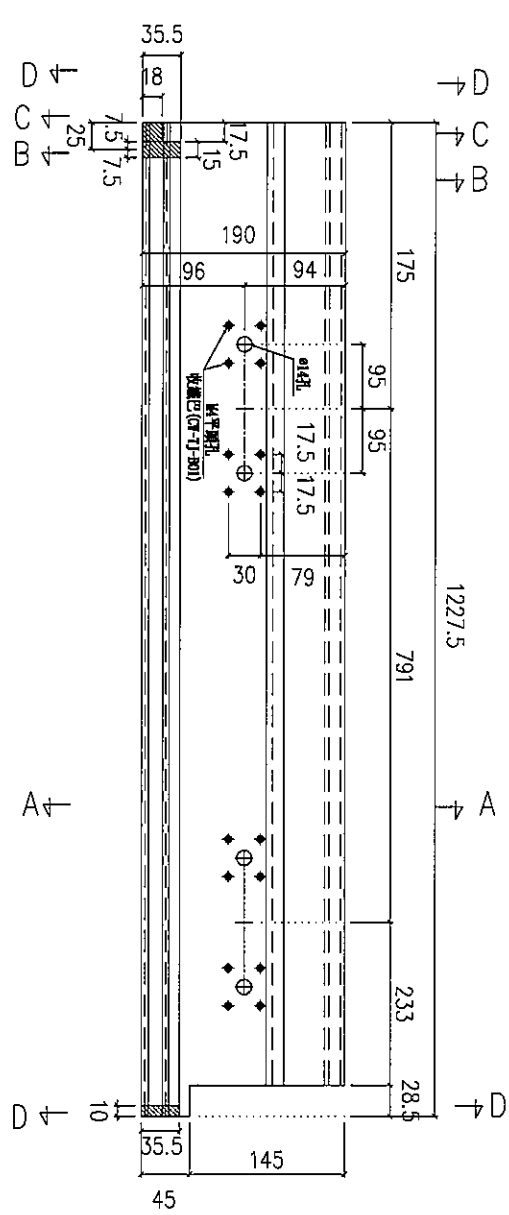
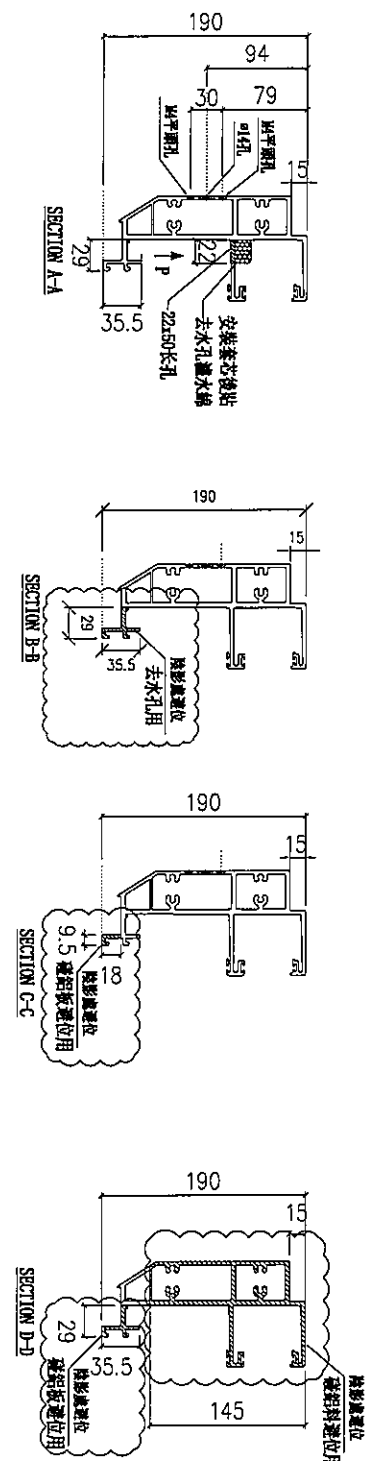

數量: 1

使用位置: J853-SD-CW-4203

名稱	頂橫	制圖	陳敏聰	2022.03.16	修改
材料	X85982	復核	謝永林	2022.03.19	日期
顏色	JMQ213457(3 coatings)	批准			圖號
					J853-T2-CW-S08

請用A3紙打印

使用位置 J853-SD-CW-4204

數量: 1

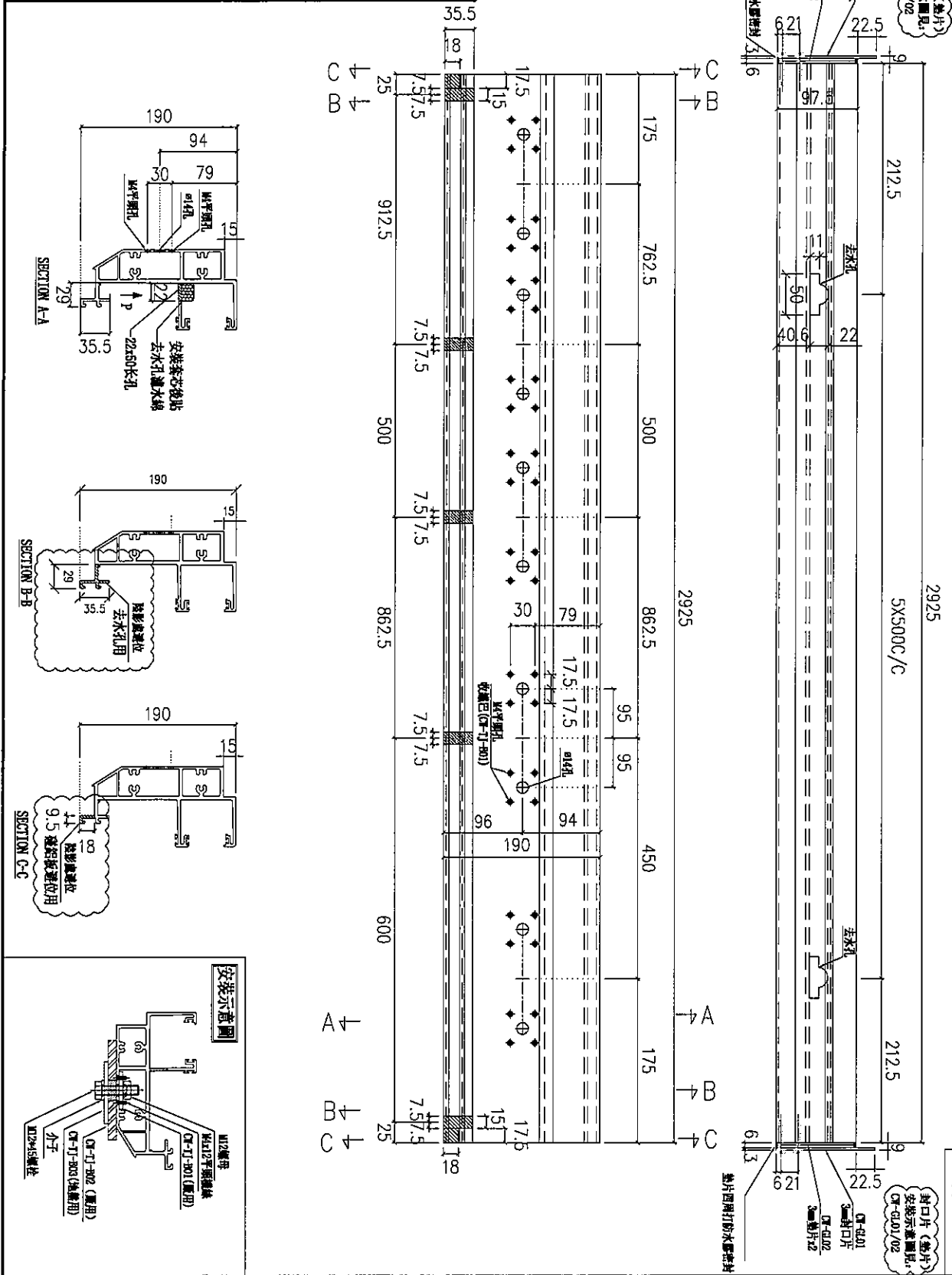

名稱	頂橫	制圖	陳敏聰	2022.03.16	修改
材料	X85982	復核	謝永林	2022.03.19	日期
顏色	JMQ213457(3 coatings)	批准			圖號
					J853-T2-CW-S09



美特鋁質有限公司
MIDI Aluminium Fabricator Ltd.

工程號 J-853 地盤 延坪道

請用A3紙打印

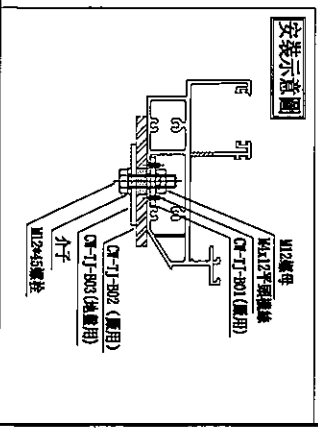
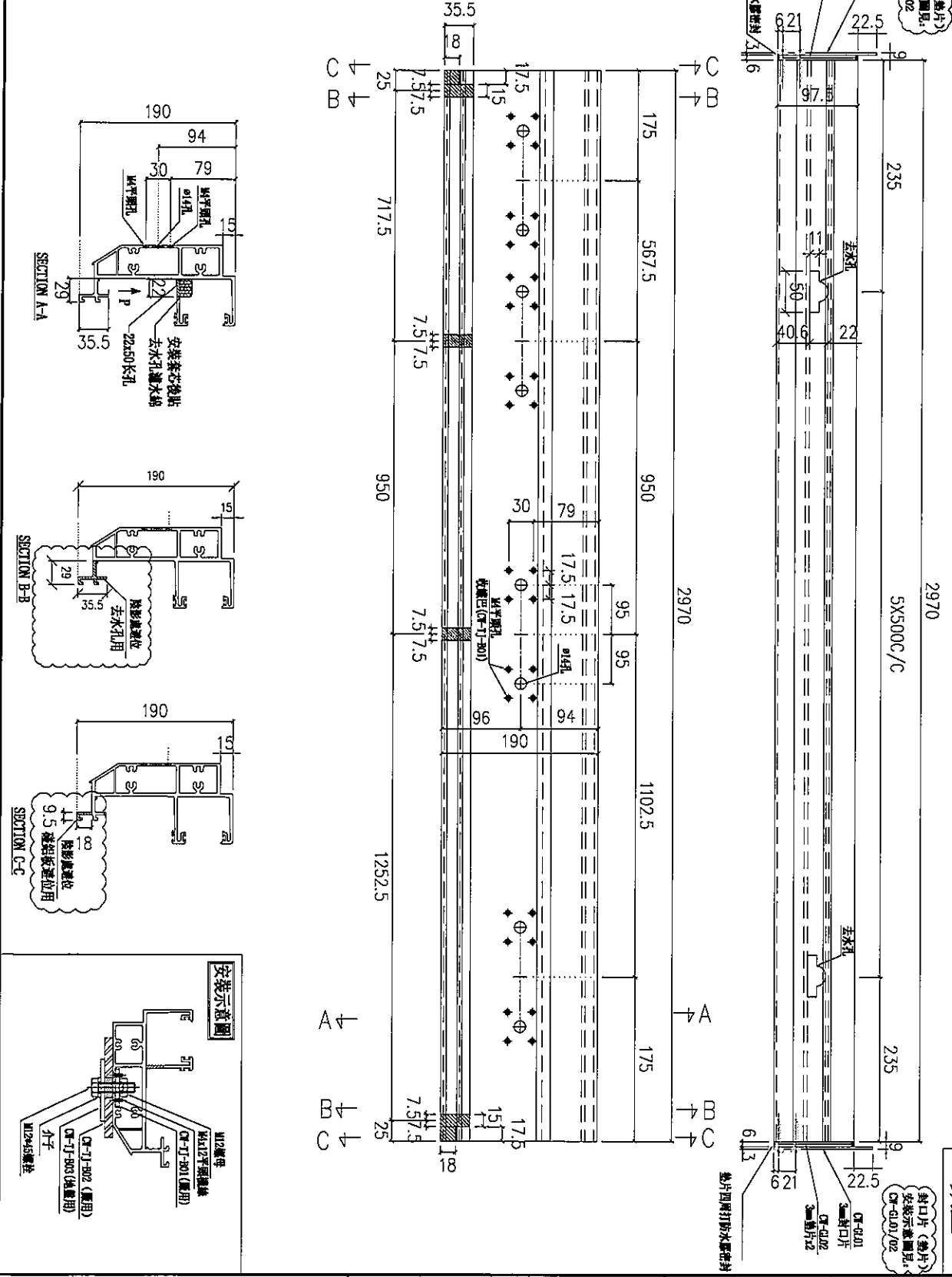

名稱	頂橫	制圖	陳敏聰	2022.03.16	修改
材料	X85982	復核	謝永林	2022.03.19	日期
顏色	JMQ213457(3 coatings)	批准			圖號 J853-T2-CW-S10



美特鋁質有限公司
MIDI Aluminium Fabricator Ltd.

工程號 J-853 地盤 延坪道

請用A3紙打印

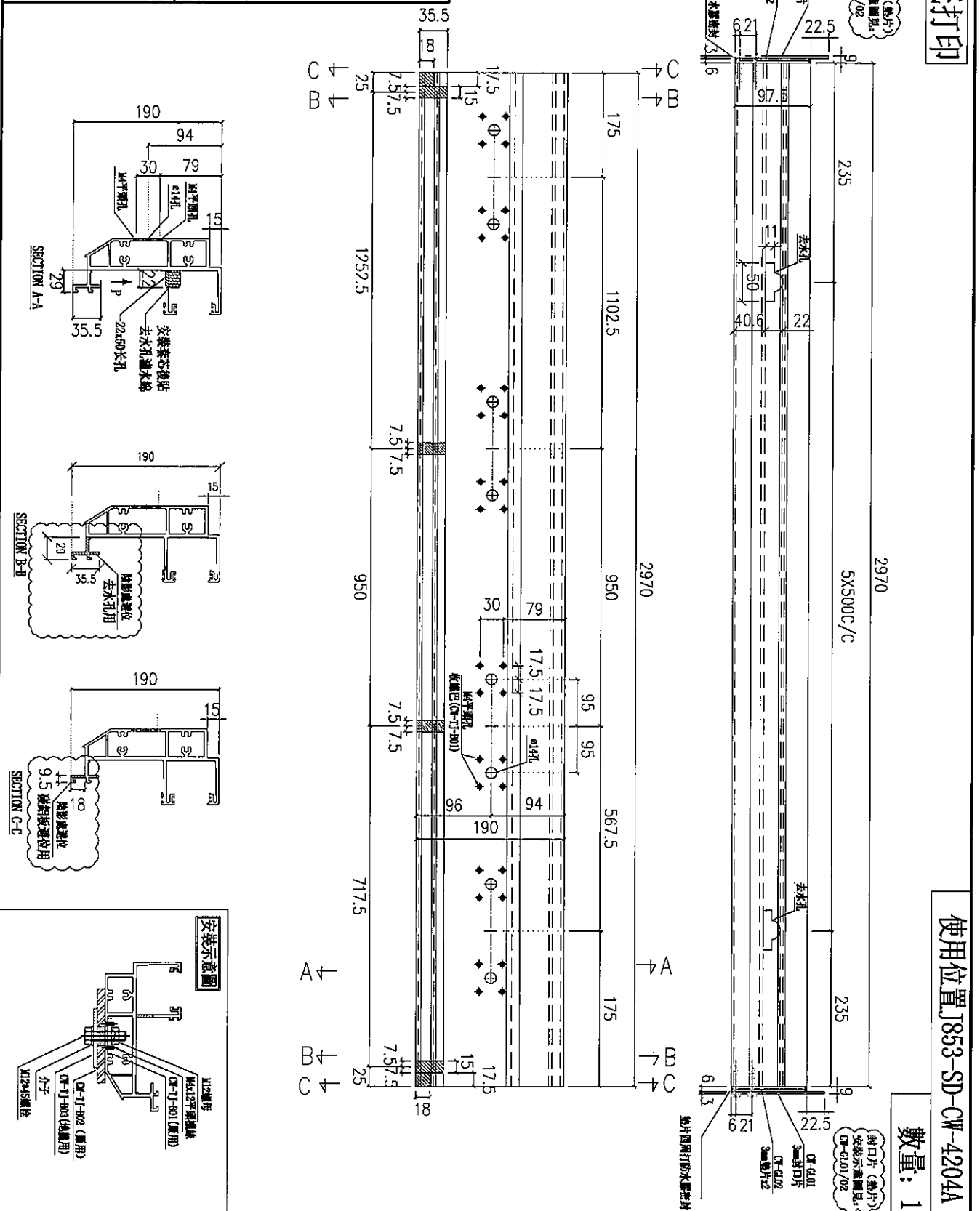

名稱	頂橫	制圖	陳敏聰	2022.03.16	修改
材料	X85982	復核	謝永林	2022.03.19	日期
顏色	JMQ213457 (3 coatings)	批准			圖號
					J853-T2-CW-S11



美特鋁質有限公司
MIDI Aluminium Fabricator Ltd.

工程號 J-853 地盤 延坪道

請用A3紙打印

使用位置 J853-SD-CW-4205

數量: 1

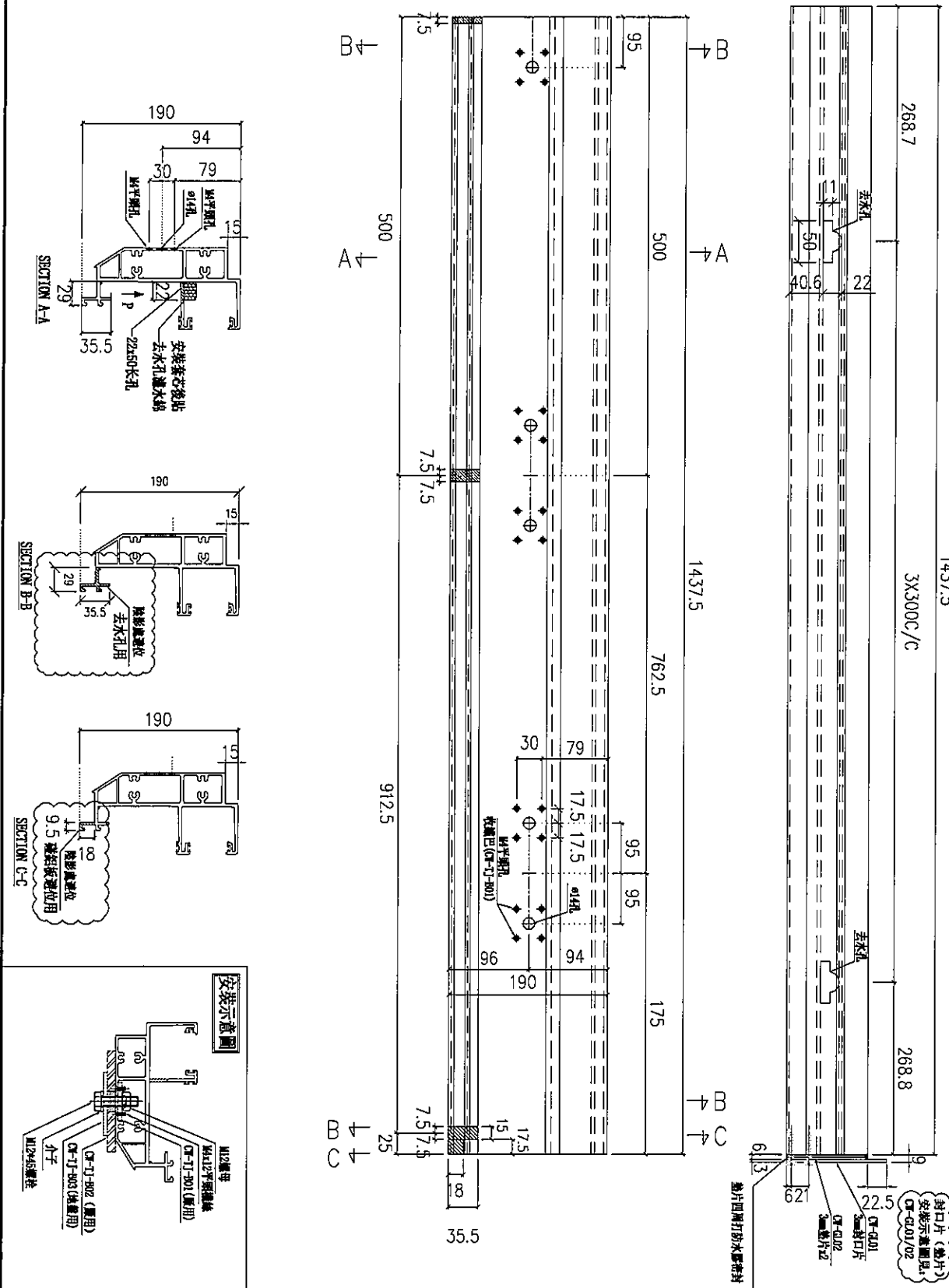

名稱	頂橫	制圖	陳敏聰	2022.03.16	修改	
材料	X85982	復核	謝永林	2022.03.19	日期	
顏色	JMQ213457(3 coatings)	批准			圖號	J853-T2-CW-S12b



請用A3紙打印

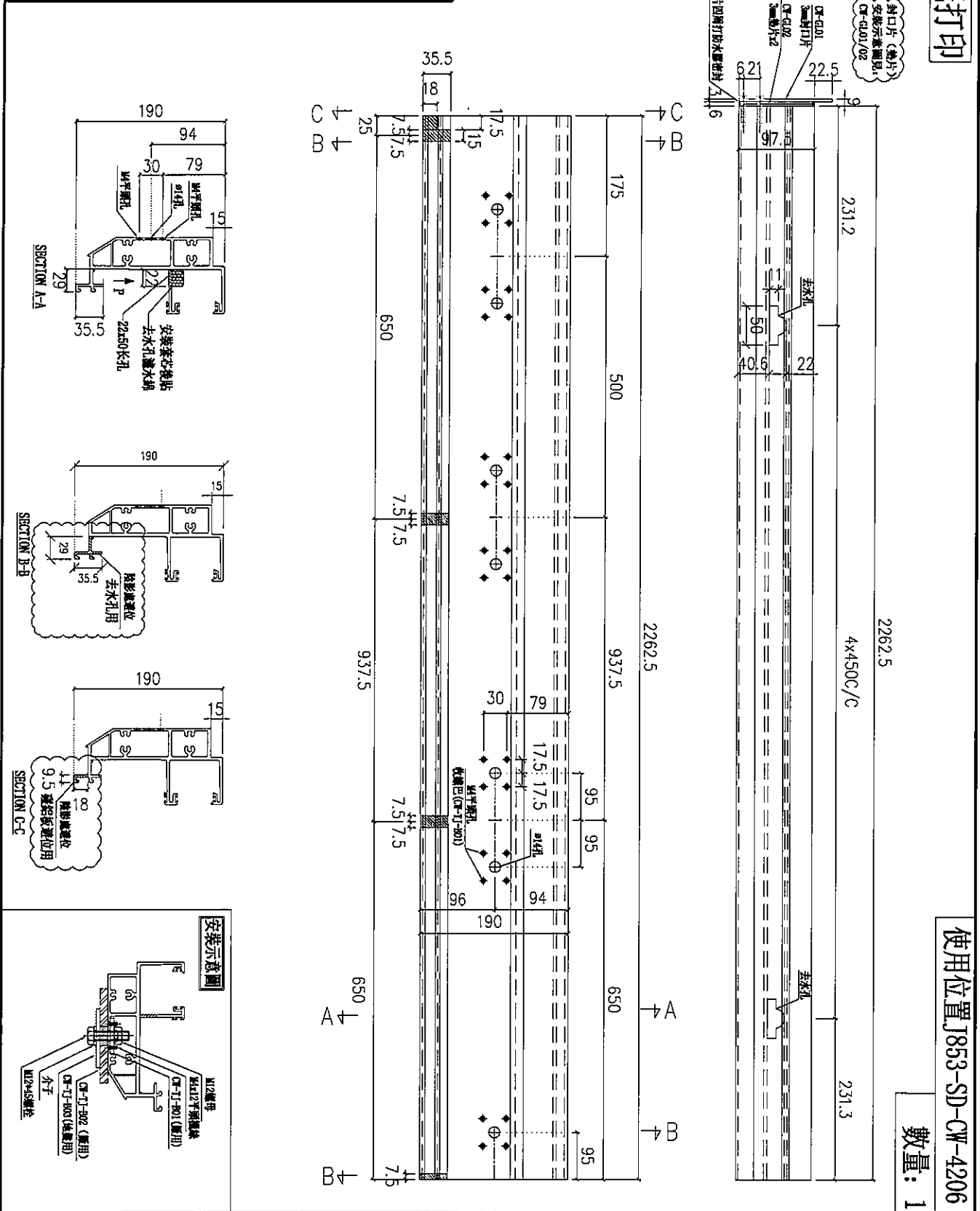

使用位置 J853-SD-CW-4206
數量: 1

名稱	頂橫	制圖	陳敬聰	2022.03.16	修改
材料	X85982	復核	謝永林	2022.03.19	日期
顏色	JMQ213457(3 coatings)	批准			圖號 J853-T2-CW-S13a



美特鋁質有限公司
MIDI Aluminium Fabricator Ltd.

工程號 J-853 地盤 延坪道

請用A3紙打印

使用位置 J853-SD-CW-4209

數量: 1

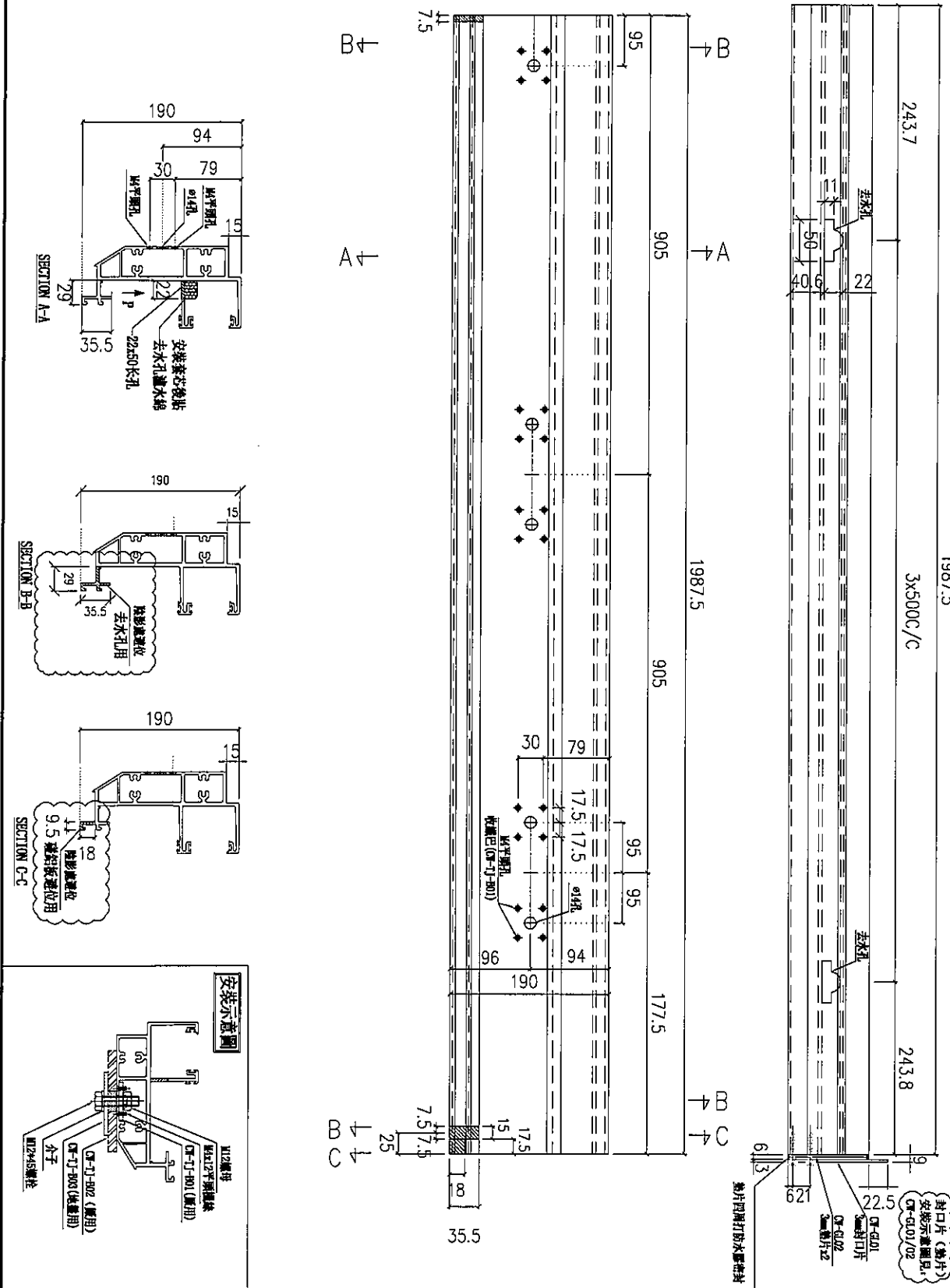

名稱	頂橫	制圖	陳敏聰	2022.03.16	修改		
材料	X85982	復核	謝永林	2022.03.19	日期		
顏色	JMQ213457(3 coatings)	批准			圖號	J853-T2-CW-S13b	

美特鋁質有限公司
MIDI Aluminium Fabricator Ltd.

工程號 J853 地盤 延坪道

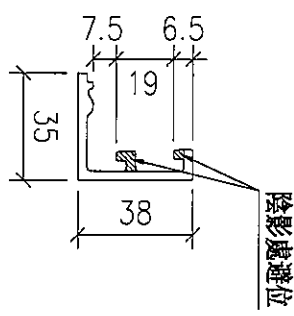
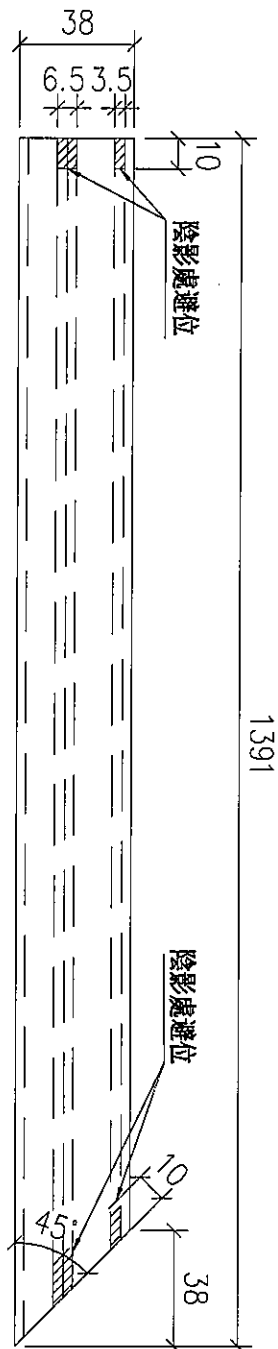

圖號	扣蓋長度 (L)	分格寬度	數量	使用位置
J853-T2-CW-KG06	1391	1400	1	J853-SD-CW-4203

名稱	玻璃扣蓋	制圖	陳敏聰	2022.03.15	修改	
材料	X85989	復核	謝永林	2022.03.19	日期	
顏色	JMQ213457(3 coatings)	批准			圖號	J853-T2-CW-KG06

美特鋁質有限公司
MIDI Aluminium Fabricator Ltd.

工程號 J853 地盤 延坪道

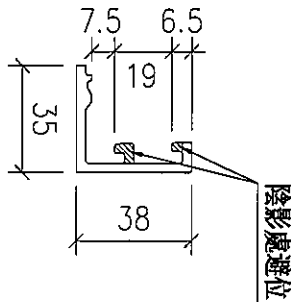

圖號	J853-T2-CW-KG07	扣蓋長度 (L)	806	分格寬度	815	數量	1	使用位置	J853-SD-CW-4203
----	-----------------	----------	-----	------	-----	----	---	------	-----------------

名稱	玻璃扣蓋	制圖	陳敏聰	2022.03.15	修改				
材料	X85989	復核	謝永林	2022.03.19	日期				
顏色	JMQ213457(3 coatinas)	批准			圖號	J853-T2-CW-KG07			

B.D. REF :

請用A3紙打印

SHIMAO GROUP HOLDINGS LIMITED
 ARCHITECT : WING TUNG & PARTNERS LIMITED
WT
 MAIN CONTRACTOR : 協興建築有限公司
HP HING CONSTRUCTION CO. LTD
 STRUCTURAL ENGINEER :
CMA C.M.WONG & ASSOCIATES LTD
 黃志輝建築工程師有限公司
 FACADE CONSULTANT :
MEINHARDT

NOTE:
 1. ALL DIMENSIONS ARE IN mm.
 2. ALL ELEVATIONS ARE VIEWED FROM OUTSIDE.
 3. ALL DIMENSIONS TO BE VERIFIED ON SITE BEFORE FABRICATION.

LEGEND:
 1. 1.1. F.F.L. - FINISHED FLOOR LEVEL.
 1.2. S.F.L. - STRUCTURAL FLOOR LEVEL.
 1.3. 2. - REVERSED DETAIL.

REVISION:
 1. 1.1. REVISION NO.
 1.2. 2. - REFER SHEET NO.

NO.	DATE	REVISION
1	09-10-2017	ISSUED SUBJECT TO MAIN CONTRACT
2		
3		

JMB NO. : J-853
 PROJECT : PROPOSED RESIDENTIAL DEVELOPMENT AT H.K.L.L. 6542 YUN PING ROAD, KOWLOON

TITLE : PART ELEVATION FOR CURTAIN WALL AT TOWER 3

DATE : 26-MAR-21 SCALE : 1:60 (A1)
 DRAWN BY : LHR CHECKED BY :
美特銘有限公司
 MIDEL
 11/F, Sunny Industrial Centre, 117
 142,340,311-4, TEL: (852) 27727866
 ENG. NO. : 0653-30-CW-4301 REV. : -

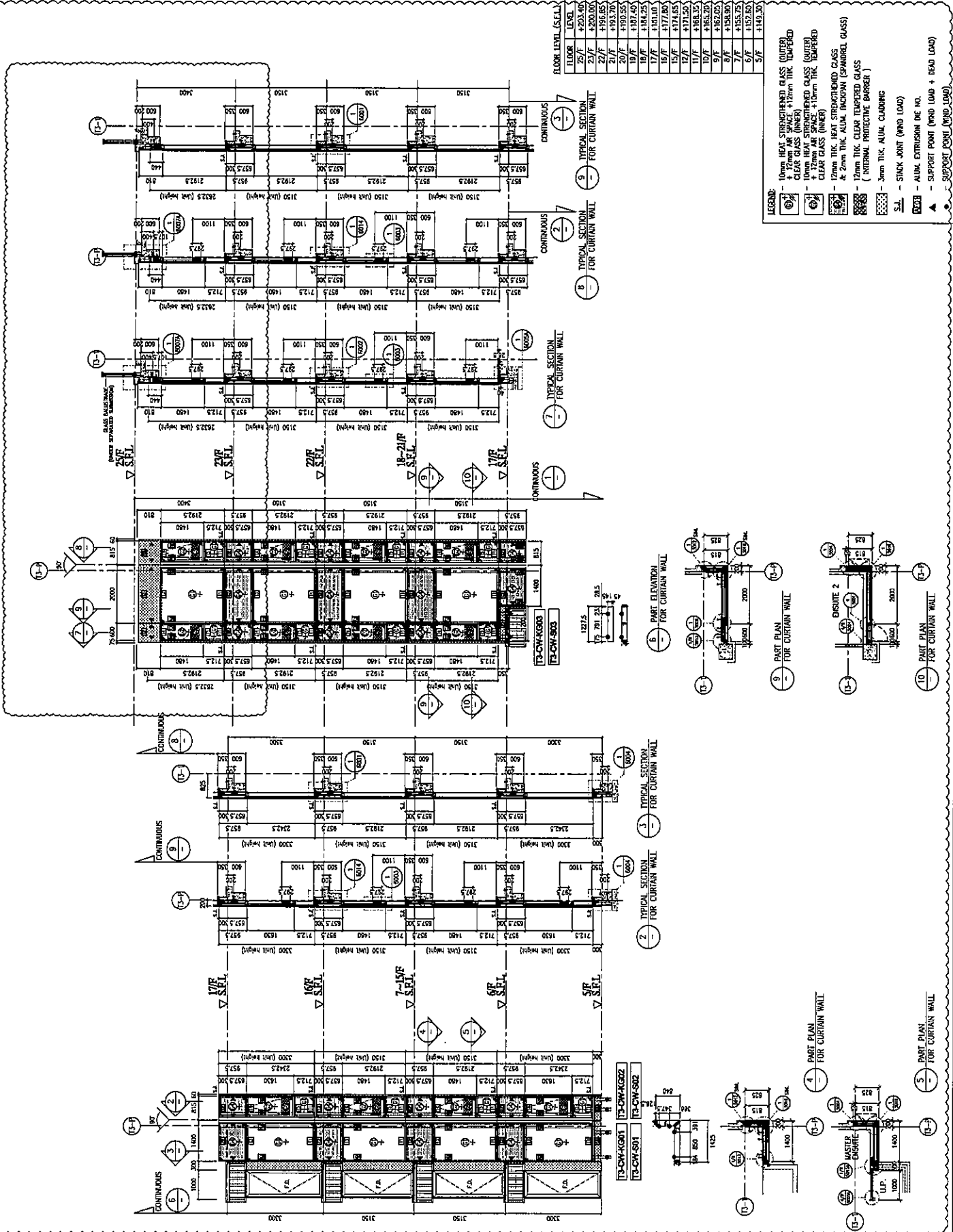

B.D. REF :

請用A3紙打印

CLIENT : SHIMAO GROUP HOLDINGS LIMITED

ARCHITECT : WING YING & PARTNERS LIMITED



MAIN CONTRACTOR : 協興建築有限公司

STRUCTURAL ENGINEER : CMA

C.M. WONG & ASSOCIATES LTD

FAÇADE CONSULTANT : MEINHARDT



NOTE: 1. ALL DIMENSIONS ARE IN METERS. 2. ALL ELEVATIONS ARE VIEWED FROM OUTSIDE. 3. ALL DIMENSIONS TO BE VERIFIED ON SITE BEFORE FABRICATION.

LEGEND: 1. DETAIL WORK NO. 2. REFER SHEET NO.

1. F.F.L. - FINISHED FLOOR LEVEL. 2. S.F.L. - STRUCTURAL FLOOR LEVEL. 3. - REVERSED DETAIL.

4	09-10-2018	REVISION SUBJECT TO WORK COMPLETION	REVISED
JOB NO. :		J-853	

PROJECT : PROPOSED RESIDENTIAL DEVELOPMENT AT N.C.L.L. 6542 YUN FING ROAD, KOWLOON.

TITLE : PART ELEVATION FOR CURTAIN WALL AT TOWER 3

DATE : 26-MAR-21 SCALE : 1:60 (A1)

DRAWN BY : UHR CHECKED BY :



MIDI ARCHITECTURE FIRM LTD. Units 8-9, Sunny Industrial Centre, 1/F, 422-525BELL-1, Tsing Yi, New Territories, HONG KONG. TEL: (852) 27272666

DWG NO. : 9553-S0-CW-0302 REV. : A

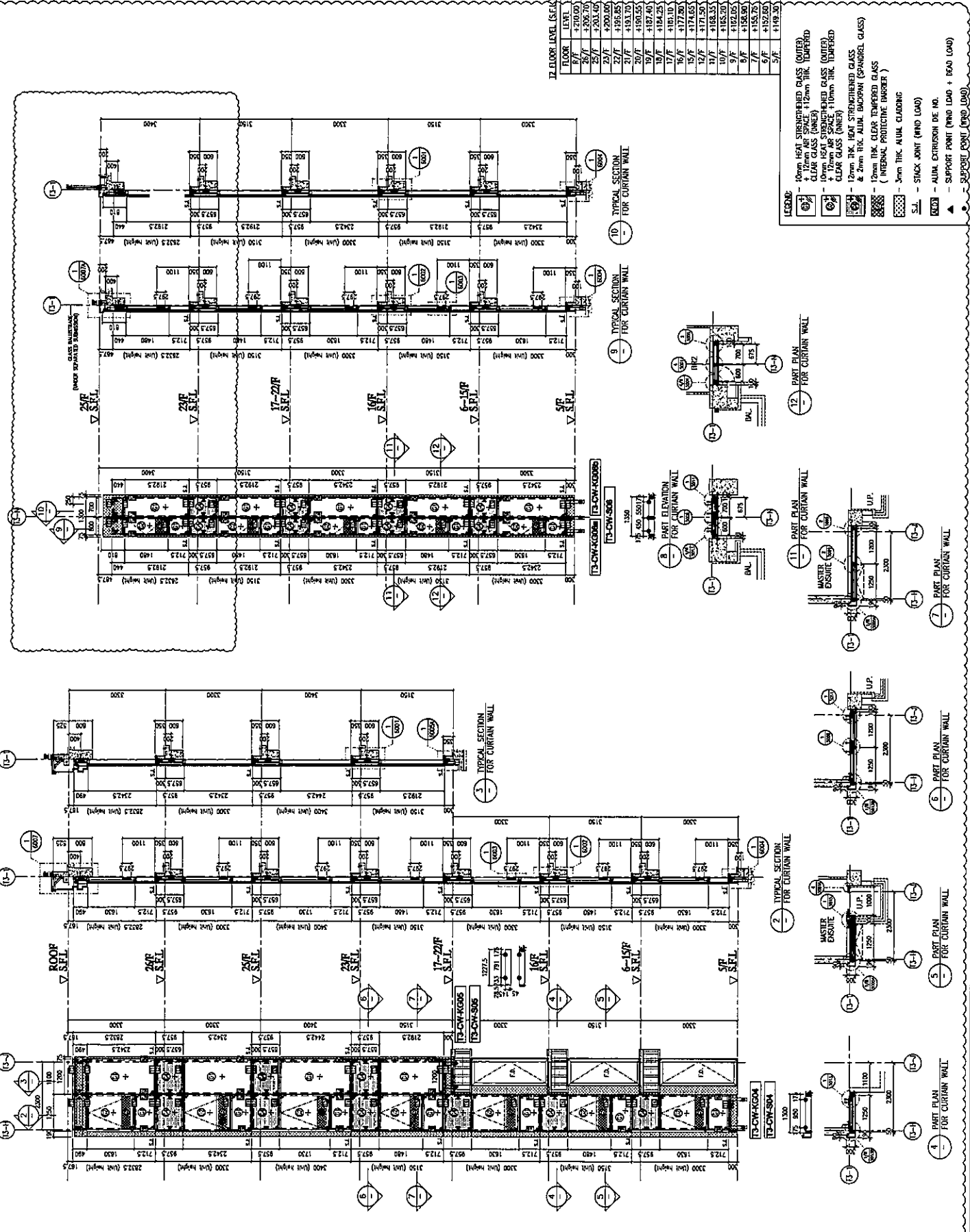

FLOOR LEVEL (S.F.L.)

FLOOR	LEVEL
R/F	+210.000
26/F	+206.710
25/F	+203.420
24/F	+200.130
23/F	+196.840
22/F	+193.550
21/F	+190.260
20/F	+186.970
19/F	+183.680
18/F	+180.390
17/F	+177.100
16/F	+173.810
15/F	+170.520
14/F	+167.230
13/F	+163.940
12/F	+160.650
11/F	+157.360
10/F	+154.070
9/F	+150.780
8/F	+147.490
7/F	+144.200
6/F	+140.910
5/F	+137.620
4/F	+134.330

- LEGEND:
- 10mm HEAT STRENGTHENED GLASS (OUTER) + 12mm AIR SPACE + 12mm THK. TEMPERED CLEAR GLASS (INNER)
 - 12mm HEAT STRENGTHENED GLASS (OUTER) + 12mm AIR SPACE + 10mm THK. TEMPERED CLEAR GLASS (INNER)
 - 12mm THK. HEAT STRENGTHENED GLASS & 2mm THK. ALUM. BACKFIN (SPANDREL GLASS)
 - 12mm THK. CLEAR TEMPERED GLASS (INTERNAL PROTECTIVE BARRIER)
 - 3mm THK. ALUM. GLAZING
 - S.S. - STACK JOINT (WIND LOAD)
 - ALUM. EXTENSION DE. NO.
 - SUPPORT POINT (WIND LOAD + HEAD LOAD)
 - SUPPORT POINT (WIND LOAD)

0.A. REF :

請用A3紙打印

CLIENT : SHIMAO GROUP HOLDINGS LIMITED

ARCHITECT : HONG LING & PARTNERS LIMITED



MAIN CONTRACTOR : 美特銳有限公司 SHIMAO CONSTRUCTION CO. LTD

STRUCTURAL ENGINEER :

CMA C H WONG & ASSOCIATES LTD 黃嘉明建築工程師有限公司

FAÇADE CONSULTANT :



NOTE: 1. ALL DIMENSIONS ARE IN MM. 2. ALL ELEVATIONS ARE VIEWED FROM OUTSIDE. 3. ALL DIMENSIONS TO BE VERIFIED ON SITE BEFORE FABRICATION.

LEGEND:

- 1. TOTAL MARK NO. 2. REFER SHEET NO. 3. F.F.L. --- FINISHED FLOOR LEVEL. 4. S.F.L. --- STRUCTURAL FLOOR LEVEL. 5. --- REVERSED DETAIL.

Table with columns: No., Description, Remarks. Row 1: 1. 20-25-MAR-21. Row 2: 2. J-853. Row 3: 3. J-853. Row 4: 4. 20-25-MAR-21. Row 5: 5. 20-25-MAR-21.

JOB NO. : J-853

PROJECT : PROPOSED RESIDENTIAL DEVELOPMENT AT N.K.L.L. 6542

YIN PING ROAD KOWLOON

TITLE : PART ELEVATION FOR CURTAIN WALL AT TOWER 3

DATE : 26-MAR-21 SCALE : 1:80 (A1)

DRAWN BY : UHR CHECKED BY :

Logo and name of Mei Te Rui (美特銳有限公司) and MIDI Management & Maintenance Co., Ltd. with contact information.

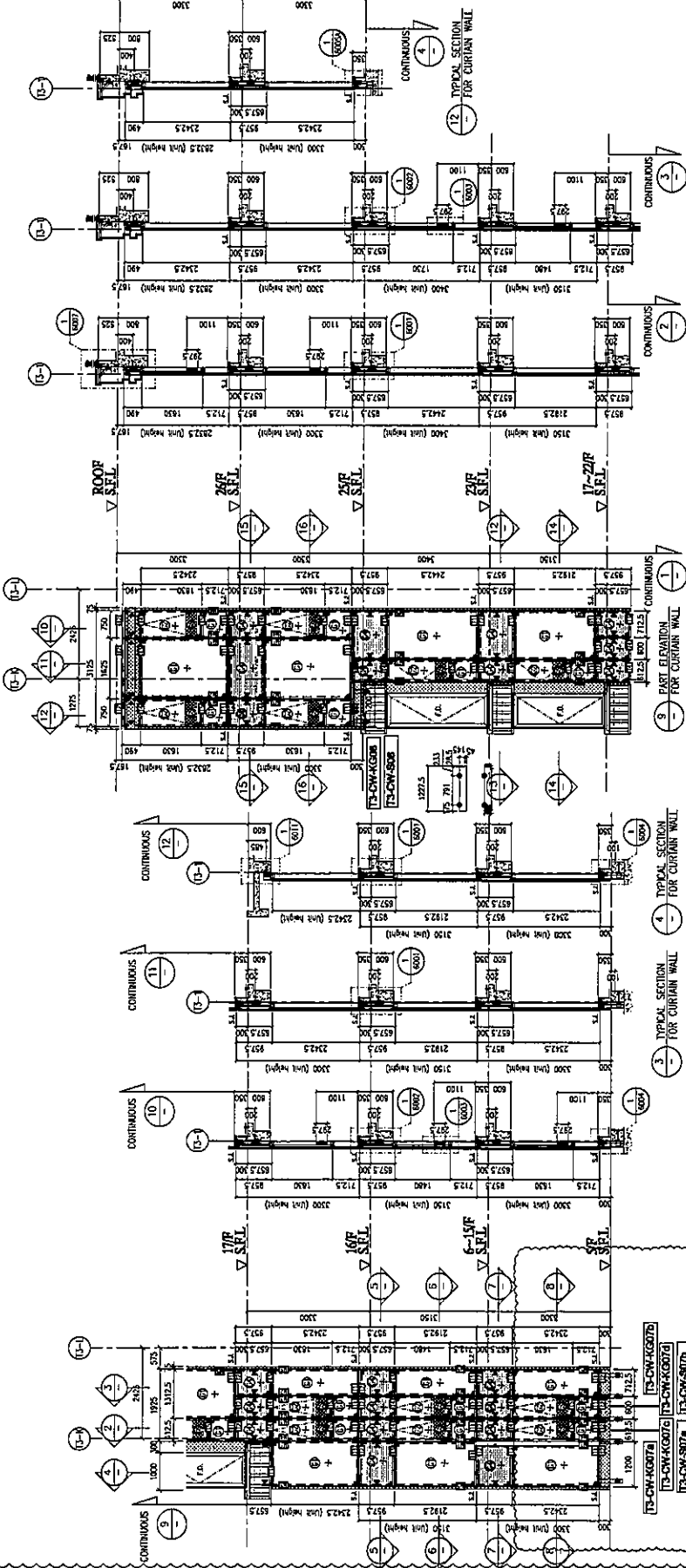

12 FLOOR LEVEL (S.F.L.) table with columns: FLOOR LEVEL, 6/F, 7/F, 8/F, 9/F, 10/F, 11/F, 12/F. Values include 420.00, 426.70, 433.40, 440.10, 446.80, 453.50, 460.20.

- LEGEND: 1. 10mm HEAT STRENGTHENED GLASS (OUTER) + 17mm AIR SPACE + 12mm THK. TEMPERED CLEAR GLASS (INNER) ENDED GLASS (OUTER) + 12mm AIR SPACE + 12mm THK. TEMPERED CLEAR GLASS (INNER). 2. 12mm THK. HEAT STRENGTHENED GLASS & 2mm THK. ALUM. INSIPANI (SPANDREL GLASS). 3. 12mm THK. CLEAR TEMPERED GLASS (INTERNAL PROTECTIVE BARRIER). 4. 3mm THK. ALUM. GLAZING. 5. S.F.L. --- STACK JOINT (WIND LOAD). 6. --- ALUM. EXTRUSION DE. 10. 7. --- SUPPORT POINT (WIND LOAD + DEAD LOAD). 8. --- SUPPORT POINT (WIND LOAD).

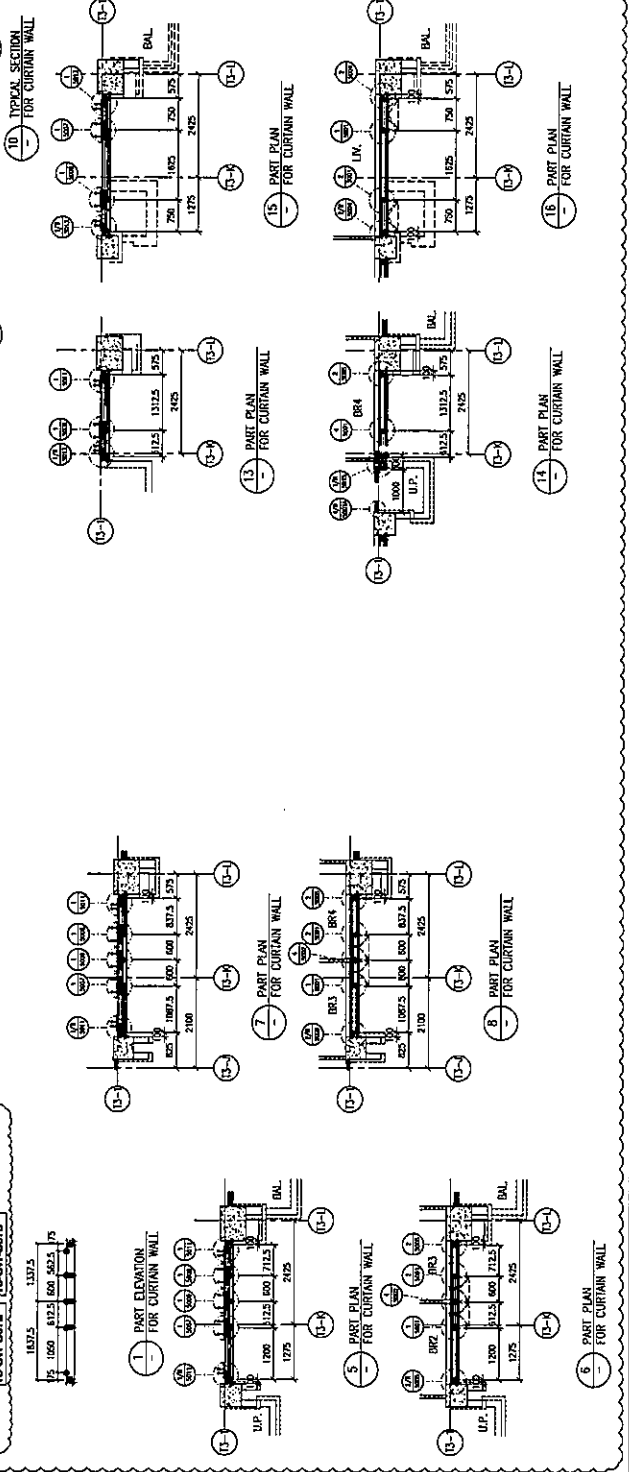

B.D. REF :

請用A3紙打印

CLIENT : SHIMAO GROUP HOLDINGS LIMITED

ARCHITECT : WONG TUNG & PARTNERS LIMITED

MAIN CONTRACTOR : 協興建築有限公司
HP-HING CONSTRUCTION CO LTD

STRUCTURAL ENGINEER : C M WONG & ASSOCIATES LTD
香港明達建築工程顧問有限公司

FAÇADE CONSULTANT : MEINHARDT

NOTE :
1. ALL DIMENSIONS ARE IN MM.
2. ALL ELEVATIONS ARE VIEWED FROM OUTSIDE.
3. ALL DIMENSIONS TO BE VERIFIED ON SITE BEFORE FABRICATION.

LEGEND :
1. DETAIL WORK NO.
2. REFER SHEET NO.

1. F.F.L. -- FINISHED FLOOR LEVEL
2. S.F.L. -- STRUCTURAL FLOOR LEVEL
3. (R) -- REVERSED BEAL

FLOOR LEVEL	LEVEL
ROOF	+210.000
28/F	+206.700
25/F	+203.400
22/F	+200.100
21/F	+198.850
20/F	+197.600
19/F	+187.400
17/F	+184.200
16/F	+183.000
15/F	+174.400
12/F	+171.500
11/F	+168.300
10/F	+165.200
8/F	+158.900
7/F	+152.600
5/F	+149.300

PROJCT : PROPOSED RESIDENTIAL DEVELOPMENT AT 141-143, YUN PING ROAD, KOWLOON

APP NO. : J-853

TITLE : PART ELEVATION FOR CURTAIN WALL AT TOWER 3

DATE : 26-MAR-21 SCALE : 1:80 (A1)

DRAWN BY : LHR CHECKED BY :

美特銘實業有限公司
MIDI ARCHITECTURE ASSOCIATES LTD.
Units 6-8, Sunny Industrial Centre, 1/F
150 Loo Yee Tung Road, Kowloon
TEL: 23288111-1 Fax: 23272186

DWG NO. : JHS3-SD-DW-4304 REV. : A

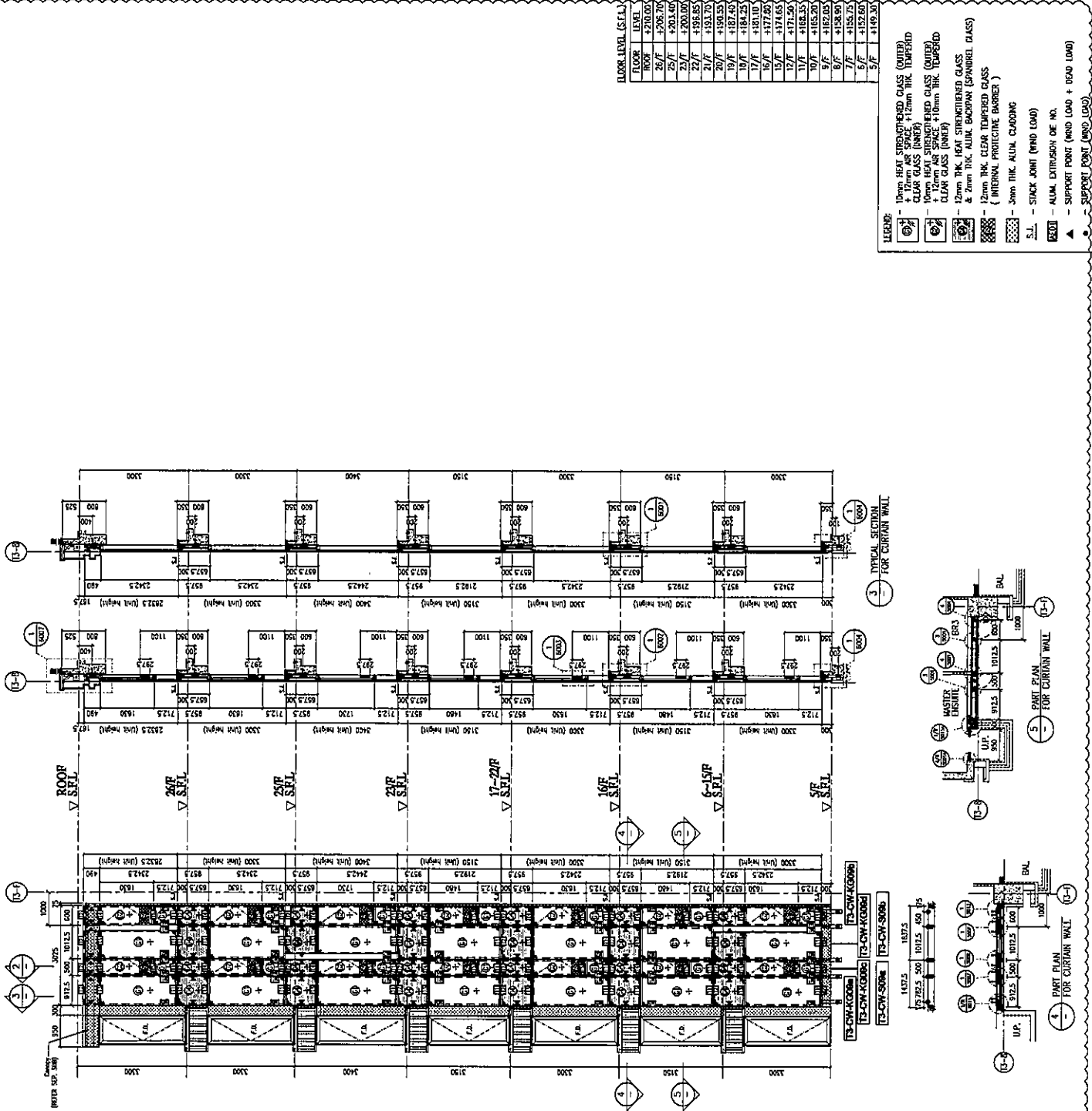

LEGEND:

- 12mm HEAT STRENGTHENED GLASS (OUTER) + 12mm AIR SPACE + 12mm THK. TEMPERED CLEAR GLASS (INNER)
- 12mm HEAT STRENGTHENED GLASS (OUTER) + 12mm AIR SPACE + 10mm THK. TEMPERED CLEAR GLASS (INNER)
- 12mm THK. HEAT STRENGTHENED GLASS & 2mm THK. ALUM. BACKPAN (SPANDREL GLASS)
- 12mm THK. CLEAR TEMPERED GLASS (INTERNAL PROTECTIVE BARRIER)
- 3mm THK. ALUM. CLADDING
- S.L. - STACK JOINT (WIND LOAD)
- ALUM. EXTRUSION DE NO.
- SUPPORT POINT (WIND LOAD + DEAD LOAD)
- SUPPORT POINT (WIND LOAD)

CLIENT :
SHIMAO GROUP HOLDINGS LIMITED

ARCHITECT :
YONG TUNG & PARTNERS LIMITED

MAIN CONTRACTOR :
**裕興建築有限公司
HP HING CONSTRUCTION CO LTD**

STRUCTURAL ENGINEER :
CMA CM WONG & ASSOCIATES LTD
黃志明建築工程顧問有限公司

FAÇADE CONSULTANT :
MEINHARDT

NOTE :
1. ALL DIMENSIONS ARE IN mm.
2. ALL DIMENSIONS ARE MEASD FROM OUTSIDE.
3. ALL DIMENSIONS TO BE VERIFIED ON SITE BEFORE FABRICATION.

LEGEND :
① RETAIL MARK NO.
② REFER SHEET NO.
③ F.F.L. — FINISHED FLOOR LEVEL
④ S.F.L. — STRUCTURAL FLOOR LEVEL
⑤ — REFERRED DETAIL

FLOOR LEVEL (S.F.L.)	FLOOR LEVEL
ROOF	+210.00
26/F	+206.70
25/F	+203.40
24/F	+200.10
23/F	+196.80
22/F	+193.50
21/F	+190.20
20/F	+186.90
19/F	+183.60
18/F	+180.30
17/F	+177.00
16/F	+173.70
15/F	+170.40
14/F	+167.10
13/F	+163.80
12/F	+160.50
11/F	+157.20
10/F	+153.90
9/F	+150.60
8/F	+147.30
7/F	+144.00
6/F	+140.70
5/F	+137.40

PROJECT :
PROPOSED RESIDENTIAL DEVELOPMENT AT 114-116, 65-42 YIP PING ROAD, KOWLOON

DATE : 23-OCT-21

SCALE : 1:60 (A1)

DRAWN BY : LHR

CHECKED BY : [Signature]

TITLE :
PART ELEVATION FOR CURTAIN WALL AT TOWER 3

PROJECT NO. : 1853-T3-CW-KG10b/c

REV. : A

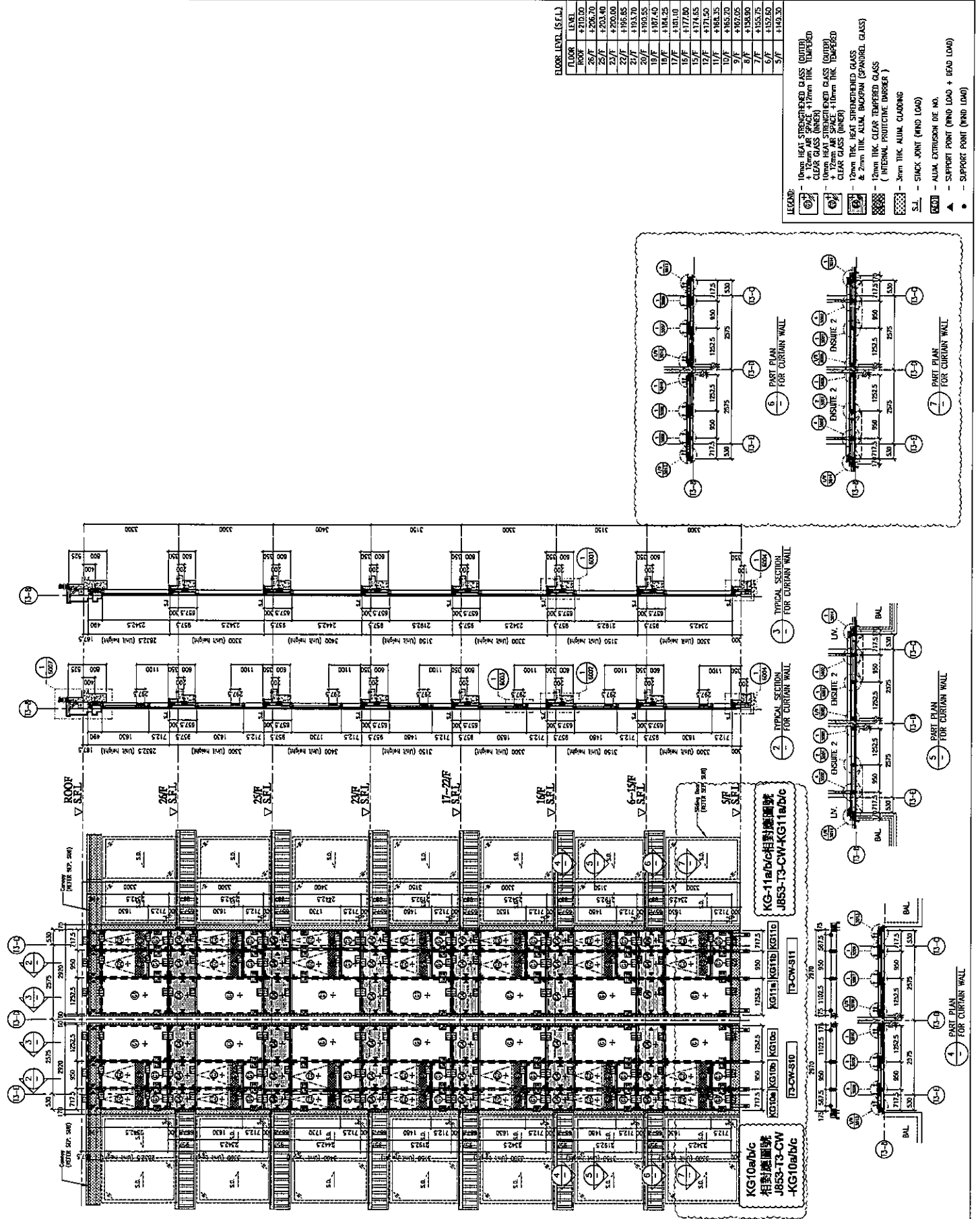

FLOOR LEVEL (S.F.L.)

FLOOR LEVEL	FLOOR LEVEL
ROOF	+210.00
26/F	+206.70
25/F	+203.40
24/F	+200.10
23/F	+196.80
22/F	+193.50
21/F	+190.20
20/F	+186.90
19/F	+183.60
18/F	+180.30
17/F	+177.00
16/F	+173.70
15/F	+170.40
14/F	+167.10
13/F	+163.80
12/F	+160.50
11/F	+157.20
10/F	+153.90
9/F	+150.60
8/F	+147.30
7/F	+144.00
6/F	+140.70
5/F	+137.40

LEGEND:

- ① 10mm HEAT STRENGTHENED GLASS (OUTER) + 12mm AIR SPACE + 12mm THK. LAMINATED CLEAR GLASS (INNER)
- ② 12mm THK. ALUM. BACKUP (SPANDREL GLASS)
- ③ 12mm THK. HEAT STRENGTHENED GLASS + 2mm THK. ALUM. BACKUP (SPANDREL GLASS) (INTERNAL PROTECTIVE BARRIER)
- ④ 3mm THK. ALUM. CLADDING
- S.L. — STACK JOINT (WIND LOAD)
- ALUM. EXTRUSION (WIND LOAD)
- SUPPORT POINT (WIND LOAD + DEAD LOAD)
- SUPPORT POINT (WIND LOAD)

B.D. REF :

請用A3紙打印

CLIENT : **SHIMAO GROUP HOLDINGS LIMITED**

ARCHITECT : **WONG TUNG & PARTNERS LIMITED**

MAIN CONTRACTOR : **協興建築有限公司 HP HING CONSTRUCTION CO LTD**

STRUCTURAL ENGINEER : **C M WONG & ASSOCIATES LTD**

FAHORE CONSULTANT : **MEINHARDT**

NOTE :

1. ALL DIMENSIONS ARE IN METRE.
2. ALL ELEVATIONS ARE VIEWED FROM OUTSIDE.
3. ALL DIMENSIONS TO BE VERIFIED ON SITE BEFORE FABRICATION.

LEGEND :

① - METAL WORK NO.

② - REFER SHEET NO.

③ - F.F.L. - FINISHED FLOOR LEVEL

④ - S.F.L. - STRUCTURAL FLOOR LEVEL

⑤ - REFERRED DETAIL

PROJECT : PROPOSED RESIDENTIAL DEVELOPMENT AT NO. 6542 YIM PING ROAD, KOWLOON

TITLE : PART ELEVATION FOR CURTAIN WALL AT TOWER 3

DATE : 05-OCT-21

SCALE : 1:60 (A1)

DRAWN BY : LHR

CHECKED BY :

PROJECT MANAGER : **美特鋁業有限公司**

Address : E-9, Sunny Industrial Centre, 1/F, 910 Chi Lok Yung Road, Kowloon

TEL: (852) 27772866

PWG NO. : JBS3-SO-CW-4305

REV. : A

FLOOR LEVEL	LEVEL
ROOF	+210.00
25/F	+206.70
25/F	+203.40
25/F	+200.00
25/F	+196.65
25/F	+193.30
25/F	+190.00
19/F	+184.40
19/F	+181.00
15/F	+177.45
12/F	+171.85
11/F	+168.35
10/F	+165.20
8/F	+158.90
7/F	+155.75
6/F	+152.60
5/F	+149.30

LEGEND :

- ① - 10mm HEAT STRENGTHENED GLASS (OUTER) + 12mm AIR SPACE + 12mm THK. TEMPERED CLEAR GLASS (INNER)
- ② - 10mm HEAT STRENGTHENED GLASS (OUTER) + 12mm AIR SPACE + 12mm THK. TEMPERED CLEAR GLASS (INNER)
- ③ - 12mm THK. HEAT STRENGTHENED GLASS & 2mm THK. ALUM. BACKPAN (SPANDREL GLASS)
- ④ - 12mm THK. CLEAR TEMPERED GLASS (INTERNAL PROTECTIVE BARRIER)
- ⑤ - 3mm THK. ALUM. CLADDING
- S.L. - STACK JOINT (WIND LOAD)
- AL. - ALUMA EXTRUSION (WIND LOAD)
- ▲ - SUPPORT POINT (WIND LOAD + DEAD LOAD)
- - SUPPORT POINT (WIND LOAD)

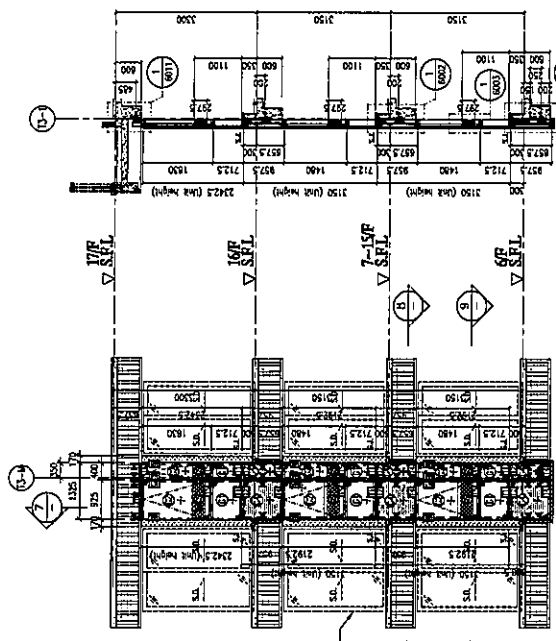

7 - TYPICAL SECTION FOR CURTAIN WALL

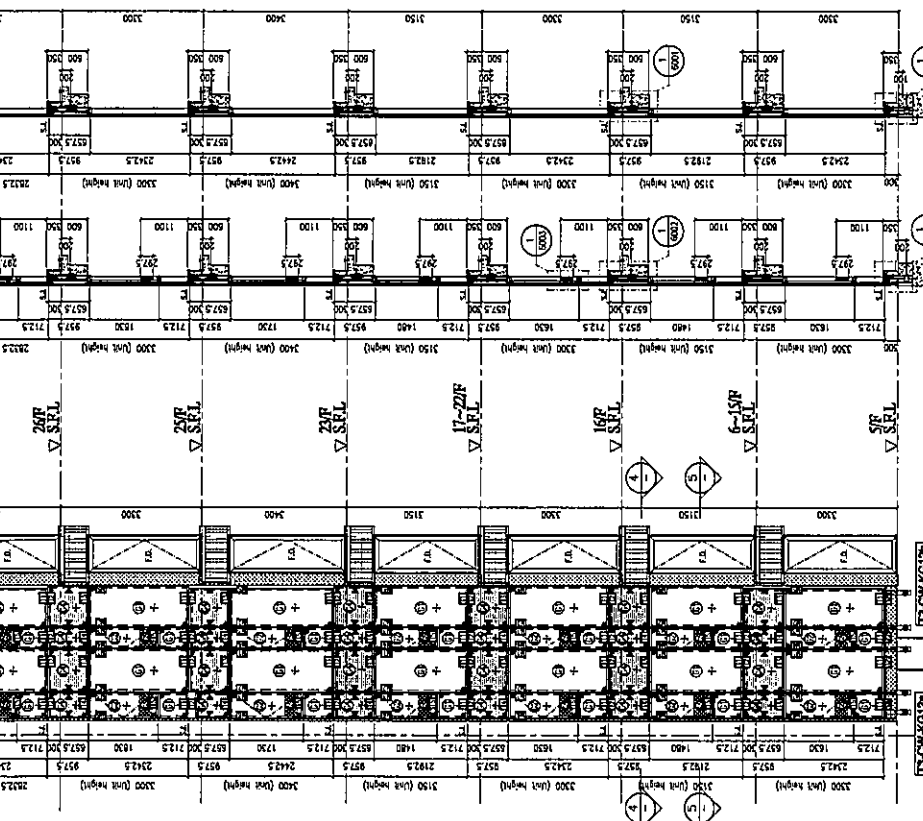

3 - TYPICAL SECTION FOR CURTAIN WALL

6 - PART ELEVATION FOR CURTAIN WALL

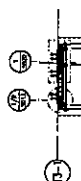

8 - PART PLAN FOR CURTAIN WALL

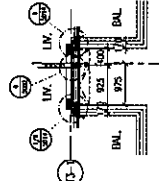

9 - PART PLAN FOR CURTAIN WALL

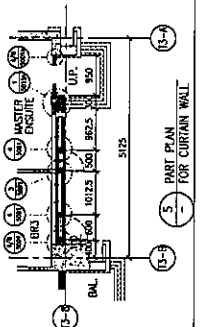

10 - PART PLAN FOR CURTAIN WALL

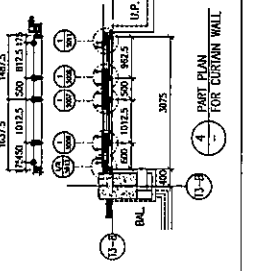

11 - PART PLAN FOR CURTAIN WALL

CLIENT : SHIMAO GROUP HOLDINGS LIMITED
 ARCHITECT : WONG TUNG & PARTNERS LIMITED
 MAIN CONTRACTOR : 協興建築有限公司
 STRUCTURAL ENGINEER : C.M. WONG & ASSOCIATES LTD
 FACADE CONSULTANT : MEINHARDT

NOTE:
 1. ALL DIMENSIONS ARE IN MM.
 2. ALL ELEVATIONS ARE VIEWED FROM OUTSIDE.
 3. ALL DIMENSIONS TO BE VERIFIED ON SITE BEFORE FABRICATION.

LEGEND:
 (A) - RETAIL MARK NO.
 (B) - REFER SHEET NO.
 1. F.F.L. -- FINISHED FLOOR LEVEL
 2. S.F.L. -- STRUCTURAL FLOOR LEVEL
 3. (A) -- REVERSED DETAIL

NO.	DATE	REVISION

JOB NO. : J-853
 PROJECT : PROPOSED RESIDENTIAL DEVELOPMENT AT A.L.L.U. 8542 YIN FING ROAD KOWLOON
 TITLE : PART ELEVATION FOR CURTAIN WALL AT TOWER 3
 DRAWN BY : LHR
 CHECKED BY :
 DATE : 05-OCT-21
 SCALE : 1:80 (A1)
 美特鋁質有限公司
 MIDITE Aluminium Fabrication Ltd.
 Units E-F, Sunny Industrial Centre, YF
 1/F, 2/F, 3/F, 4/F, 5/F, 6/F, 7/F, 8/F, 9/F, 10/F
 142, 144, 146, 148, 150, 152, 154, 156, 158, 160, 162, 164, 166, 168, 170, 172, 174, 176, 178, 180, 182, 184, 186, 188, 190, 192, 194, 196, 198, 200, 202, 204, 206, 208, 210, 212, 214, 216, 218, 220, 222, 224, 226, 228, 230, 232, 234, 236, 238, 240, 242, 244, 246, 248, 250, 252, 254, 256, 258, 260, 262, 264, 266, 268, 270, 272, 274, 276, 278, 280, 282, 284, 286, 288, 290, 292, 294, 296, 298, 300, 302, 304, 306, 308, 310, 312, 314, 316, 318, 320, 322, 324, 326, 328, 330, 332, 334, 336, 338, 340, 342, 344, 346, 348, 350, 352, 354, 356, 358, 360, 362, 364, 366, 368, 370, 372, 374, 376, 378, 380, 382, 384, 386, 388, 390, 392, 394, 396, 398, 400, 402, 404, 406, 408, 410, 412, 414, 416, 418, 420, 422, 424, 426, 428, 430, 432, 434, 436, 438, 440, 442, 444, 446, 448, 450, 452, 454, 456, 458, 460, 462, 464, 466, 468, 470, 472, 474, 476, 478, 480, 482, 484, 486, 488, 490, 492, 494, 496, 498, 500, 502, 504, 506, 508, 510, 512, 514, 516, 518, 520, 522, 524, 526, 528, 530, 532, 534, 536, 538, 540, 542, 544, 546, 548, 550, 552, 554, 556, 558, 560, 562, 564, 566, 568, 570, 572, 574, 576, 578, 580, 582, 584, 586, 588, 590, 592, 594, 596, 598, 600, 602, 604, 606, 608, 610, 612, 614, 616, 618, 620, 622, 624, 626, 628, 630, 632, 634, 636, 638, 640, 642, 644, 646, 648, 650, 652, 654, 656, 658, 660, 662, 664, 666, 668, 670, 672, 674, 676, 678, 680, 682, 684, 686, 688, 690, 692, 694, 696, 698, 700, 702, 704, 706, 708, 710, 712, 714, 716, 718, 720, 722, 724, 726, 728, 730, 732, 734, 736, 738, 740, 742, 744, 746, 748, 750, 752, 754, 756, 758, 760, 762, 764, 766, 768, 770, 772, 774, 776, 778, 780, 782, 784, 786, 788, 790, 792, 794, 796, 798, 800, 802, 804, 806, 808, 810, 812, 814, 816, 818, 820, 822, 824, 826, 828, 830, 832, 834, 836, 838, 840, 842, 844, 846, 848, 850, 852, 854, 856, 858, 860, 862, 864, 866, 868, 870, 872, 874, 876, 878, 880, 882, 884, 886, 888, 890, 892, 894, 896, 898, 900, 902, 904, 906, 908, 910, 912, 914, 916, 918, 920, 922, 924, 926, 928, 930, 932, 934, 936, 938, 940, 942, 944, 946, 948, 950, 952, 954, 956, 958, 960, 962, 964, 966, 968, 970, 972, 974, 976, 978, 980, 982, 984, 986, 988, 990, 992, 994, 996, 998, 1000
 LINE NO. : 1053-S0-CW-C306 REV. : A

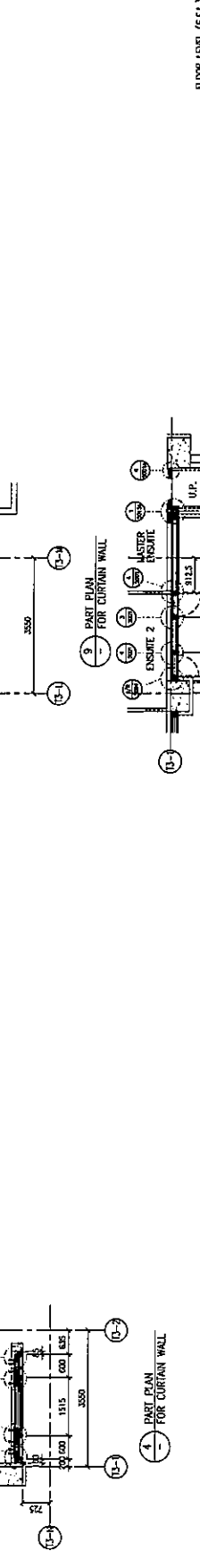
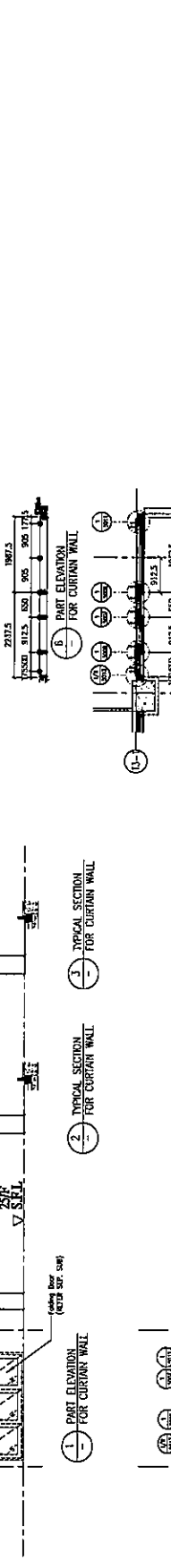
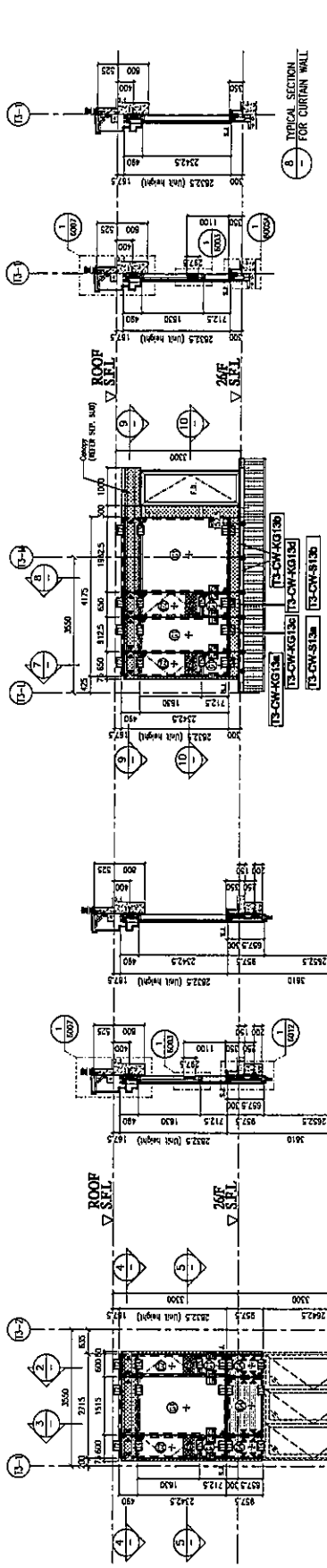

FLOOR LEVEL (S.F.L.)

FLOOR LEVEL	LEVEL
FLOOR	+205.00
ROOF	+205.70
26/F	+206.70
25/F	+203.40

- LEGEND:
- ① - 10mm HEAT STRENGTHENED GLASS (OUTER) + 12mm AIR SPACE + 17mm THK. TEMPERED CLEAR GLASS (INNER)
 - ② - 10mm HEAT STRENGTHENED GLASS (OUTER) + 12mm AIR SPACE + 17mm THK. TEMPERED CLEAR GLASS (INNER)
 - ③ - 12mm THK. HEAT STRENGTHENED GLASS & 2mm THK. ALUM. BACKFIN (SPANDREL GLASS)
 - ④ - 12mm THK. CLEAR TEMPERED GLASS (INTERNAL PROTECTIVE BARRIER)
 - ⑤ - 3mm THK. ALUM. CLADDING
 - S.L. - STACK JOINT (WIND LOAD)
 - ▲ - ALUM. EXTRUSION (WIND LOAD)
 - - SUPPORT POINT (WIND LOAD + DEAD LOAD)

EG-DWG3

美特鋁質有限公司
MIDI Aluminium Fabricator Ltd.

工程號 J-853 地盤 延坪道

請用A3紙打印

封口片 (鋁片)
安裝示意圖見:
CW-4301/02

使用位置 J853-SD-CW-4301

數量: 1

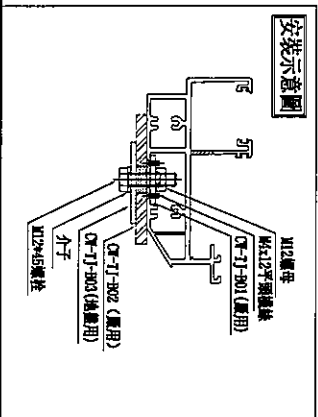
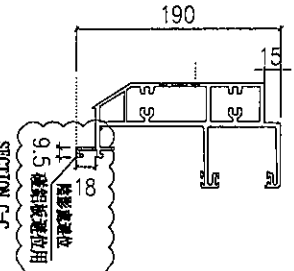
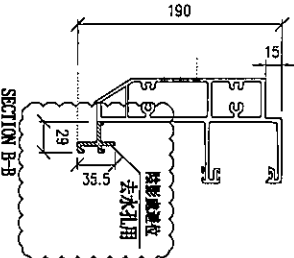
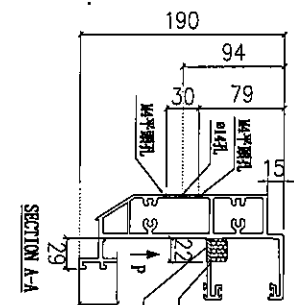
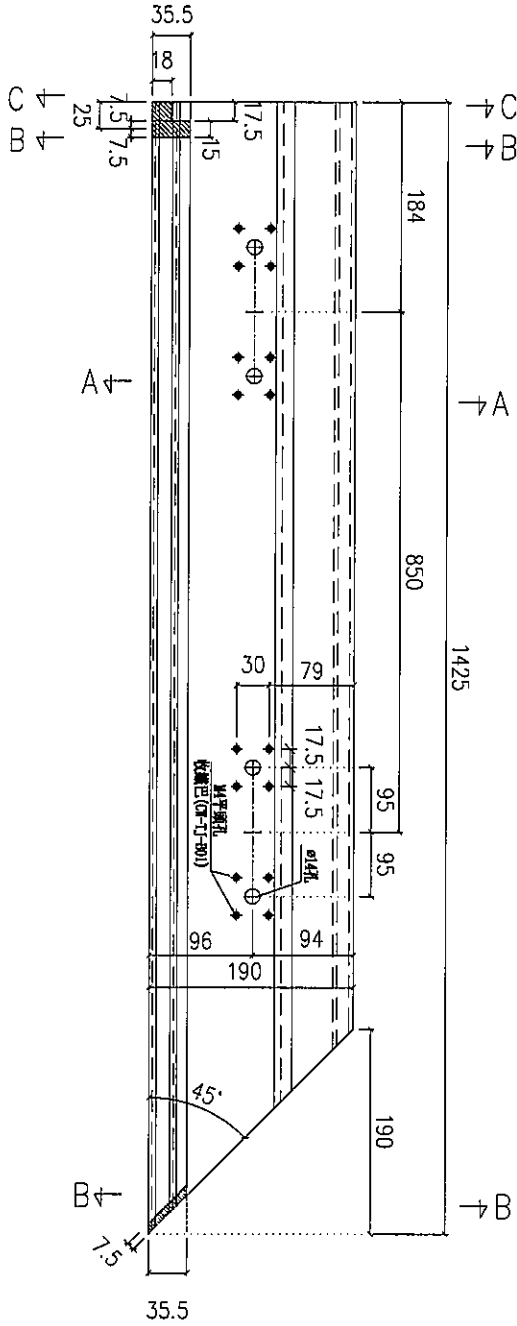
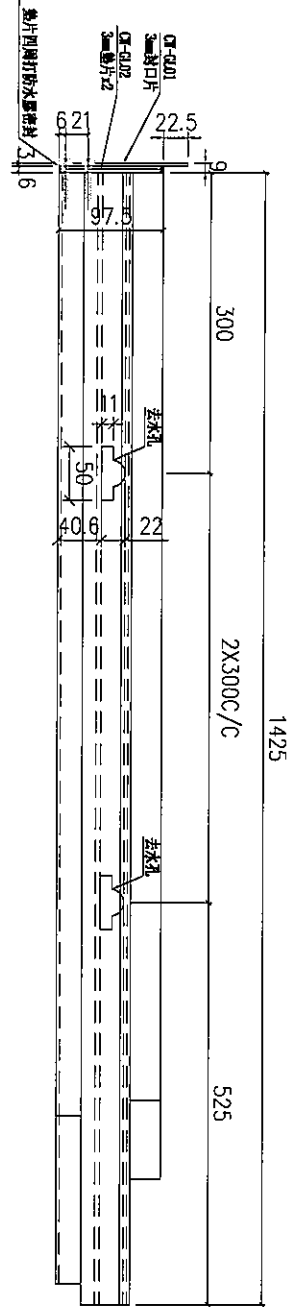

名稱	頂橫	制圖	陳敏聰	2022.03.11	修改	
材料	X85982	復核	謝永林	2022.03.17	日期	
顏色	JMQ213457(3 coatings)	批准			圖號	J853-T3-CW-S01



請用A3紙打印

使用位置 J853-SD-CW-4301

數量: 1

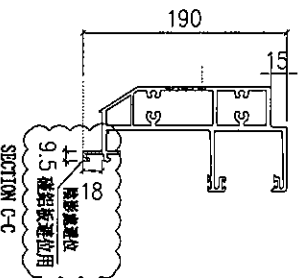
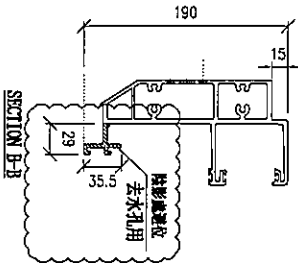
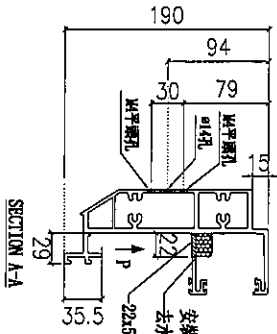
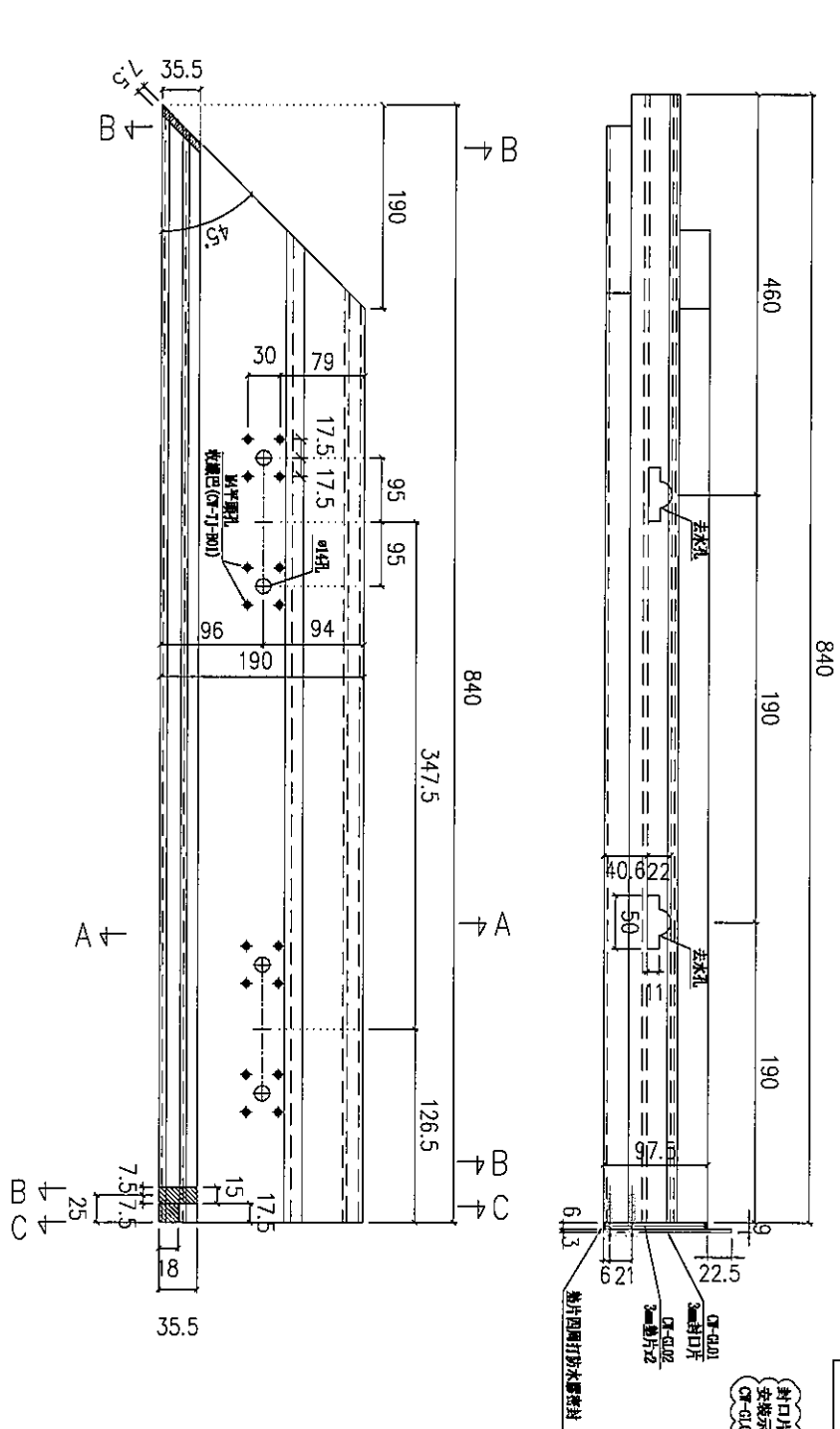

安裝示意圖

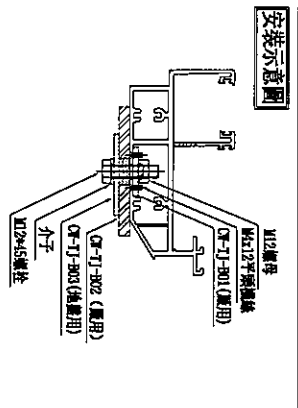

名稱	頂橫	制圖	陳敏聰	2022.03.11	修改
材料	X85982	復核	謝永林	2022.03.17	日期
顏色	JMQ213457(3 coatings)	批准			圖號 J853-T3-CW-S02

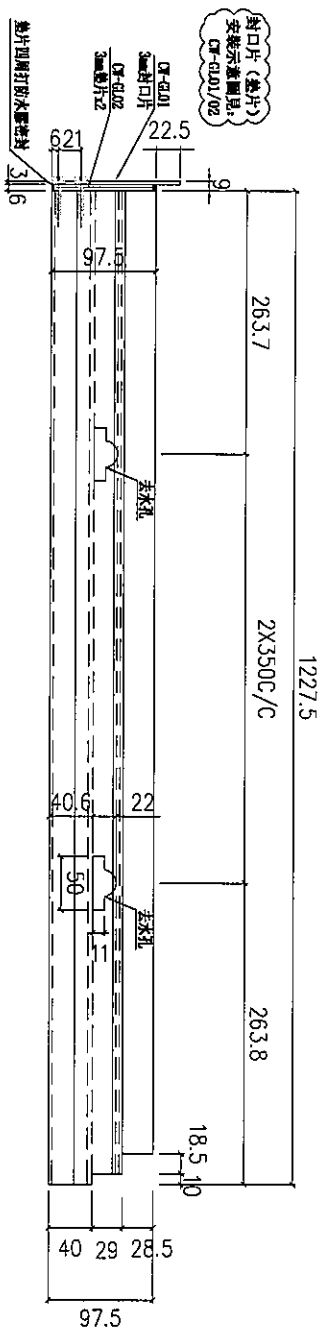
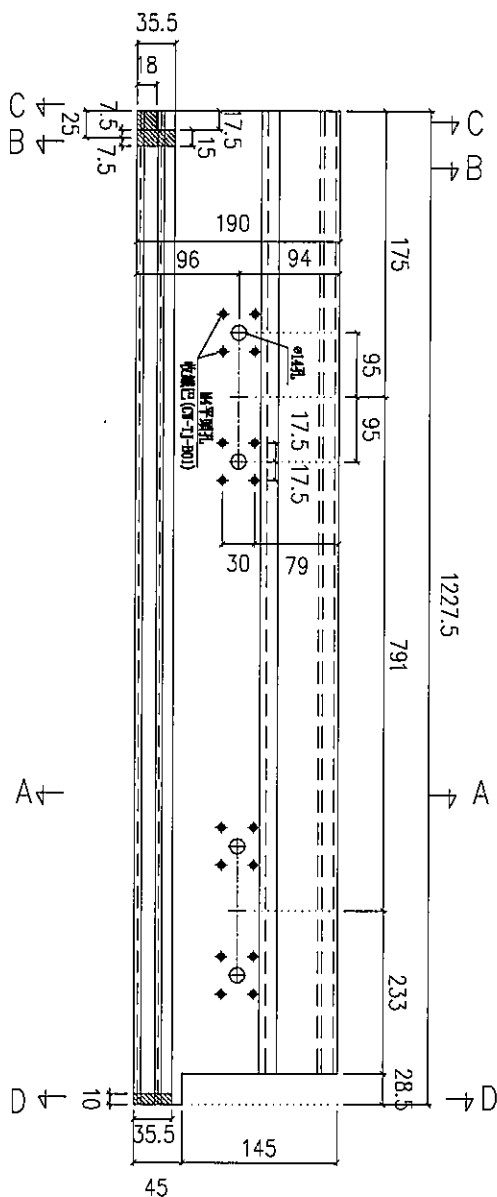
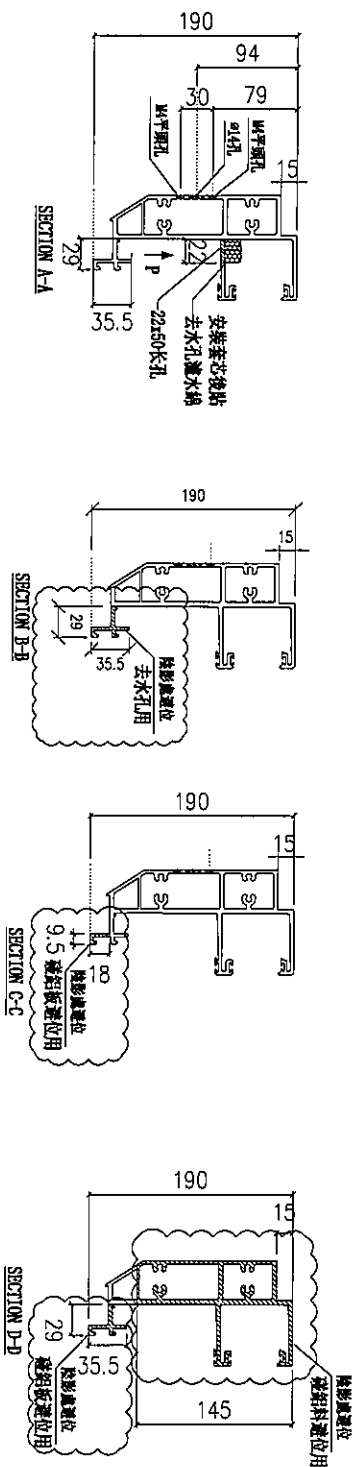

數量: 1

使用位置: J853-SD-CW-4301

名稱	頂橫	制圖	陳敏聰	2022.03.11	修改	
材料	X85982	復核	謝永林	2022.03.17	日期	
顏色	JMQ213457(3 coatings)	批准			圖號	J853-T3-CW-S03

請用A3紙打印

使用位置 J853-SD-CW-4302

數量: 1

封口片 (鋁片)
安裝示意圖見:
CW-0101/02

封口片 (鋁片)
安裝示意圖見:
CW-0101/02

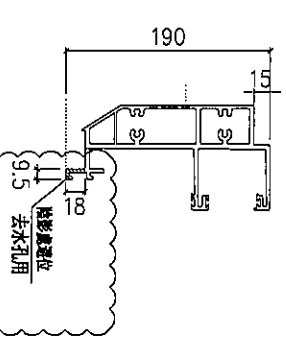
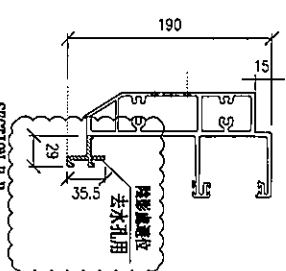
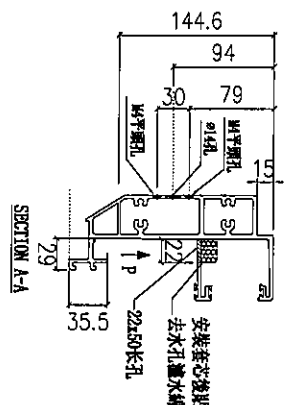
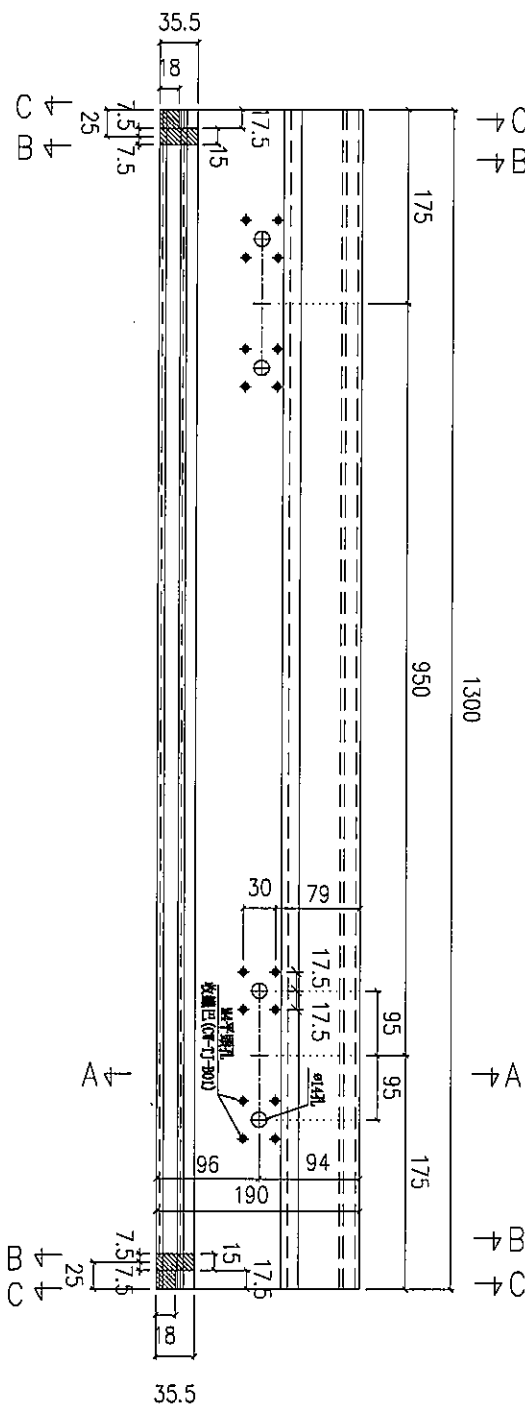
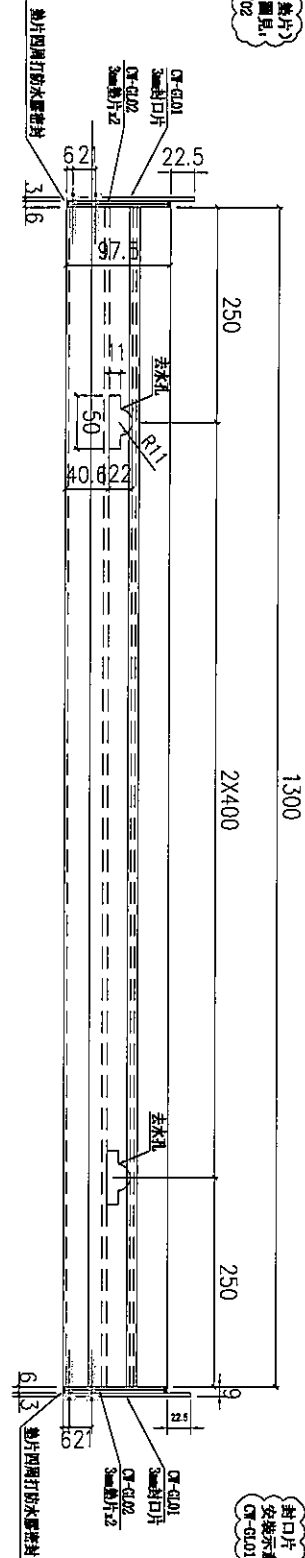

安裝示意圖

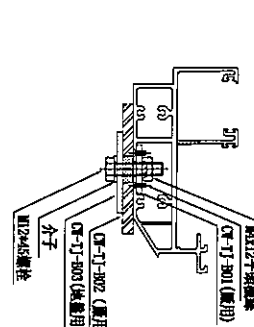

名稱	頂橫	制圖	陳敏聰	2022.03.11	修改
材料	X85982	復核	謝永林	2022.03.17	日期
顏色	JMQ213457(3 coatings)	批准			圖號 J853-T3-CW-S04



美特鋁質有限公司
MIDI Aluminium Fabricator Ltd.

工程號 J853 地盤 延坪道

請用A3紙打印

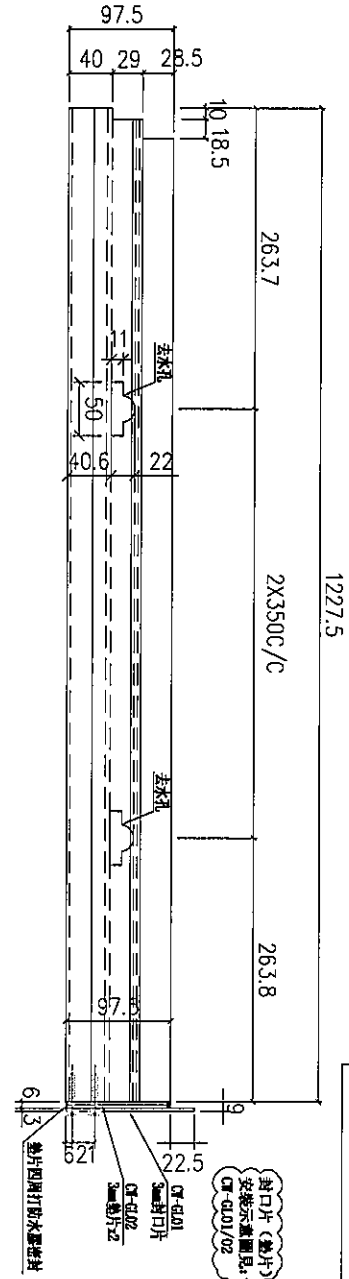
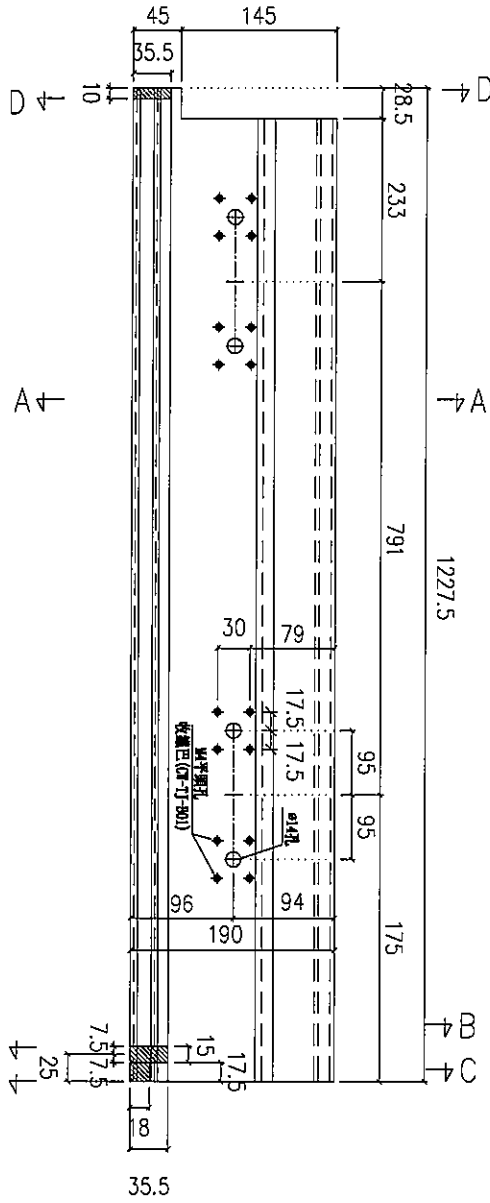
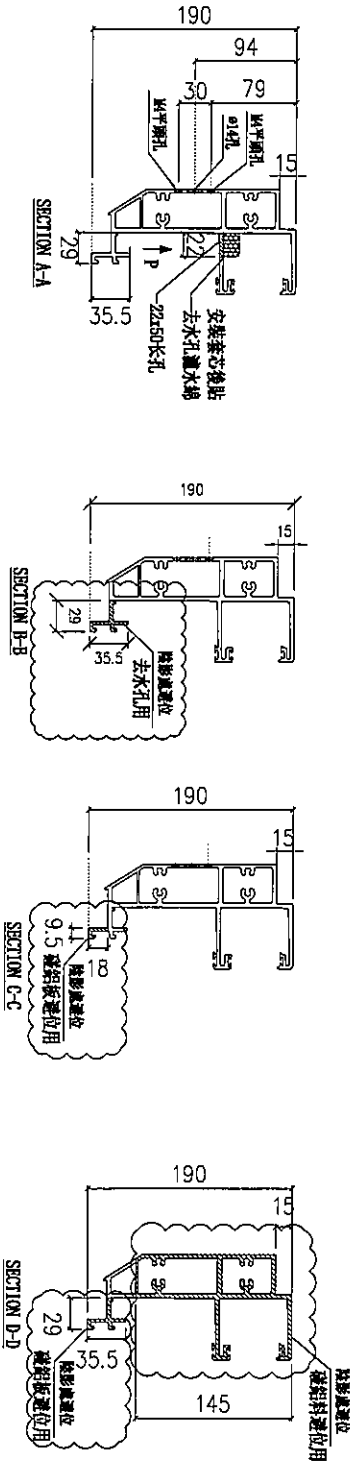

使用位置 J853-SD-CW-4302

數量: 1

名稱	頂橫	制圖	陳敏聰	2022.03.11	修改	
材料	X85982	復核	謝永林	2022.03.17	日期	
顏色	JMQ213457(3 coatings)	批准			圖號	J853-T3-CW-S05

請用A3紙打印

使用位置 J853-SD-CW-4302

數量: 1

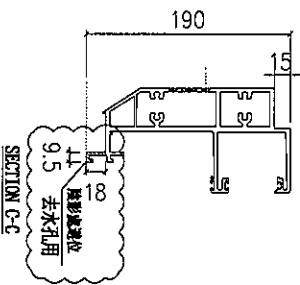
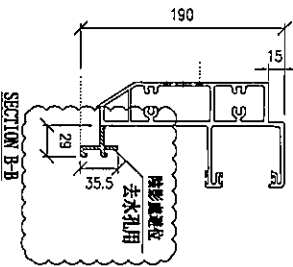
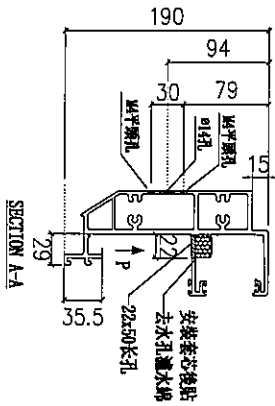
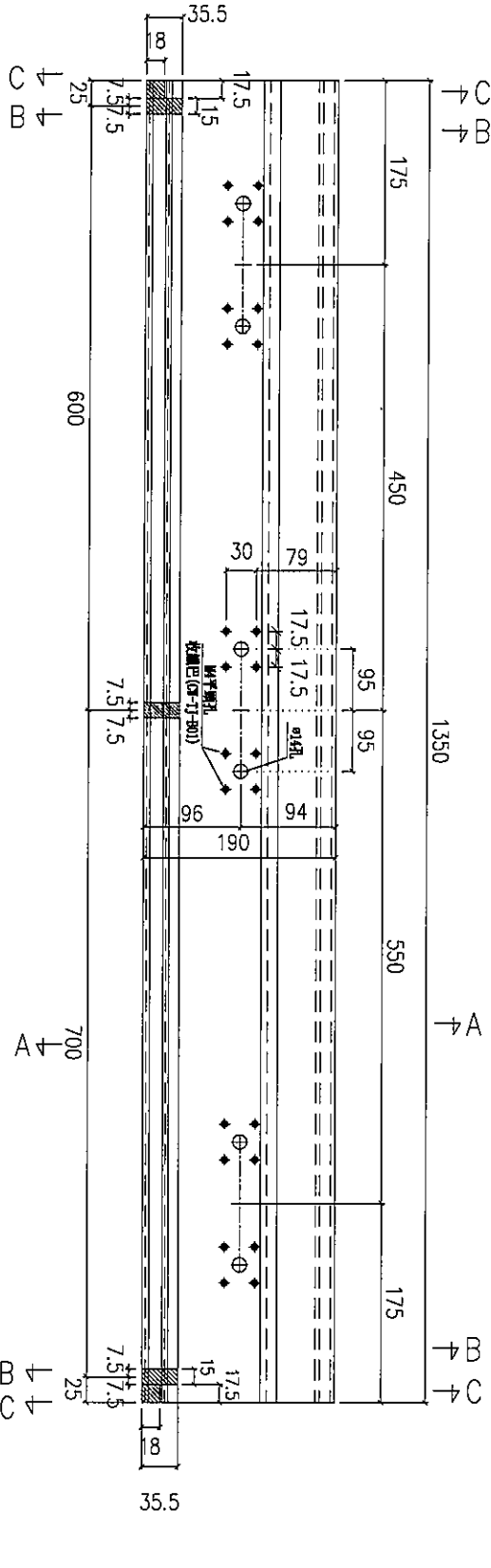
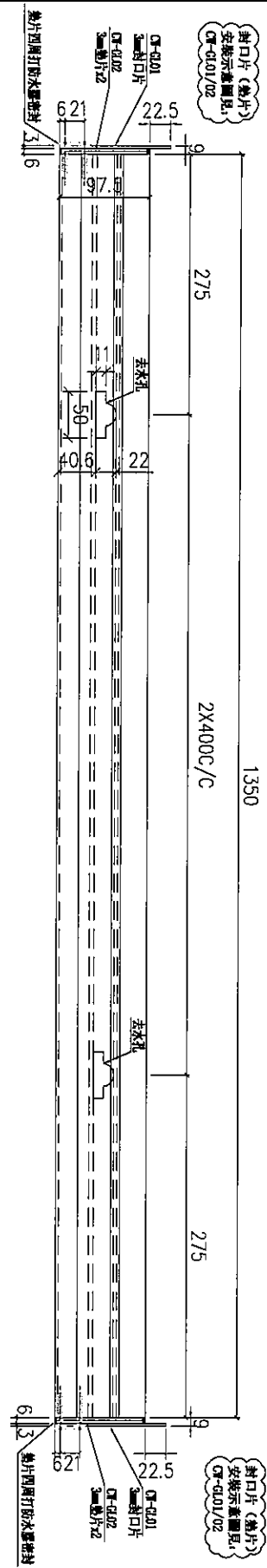

安裝示意圖

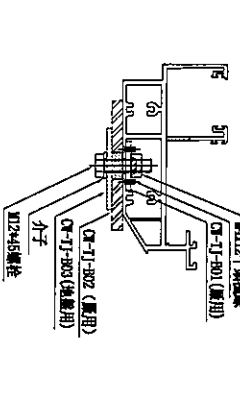

名稱	頂橫	制圖	陳敬聰	2022.03.11	修改
材料	X85982	復核	謝永林	2022.03.17	日期
顏色	JMQ213457(3 coatings)	批准			圖號 J853-T3-CW-S06

請用A3紙打印

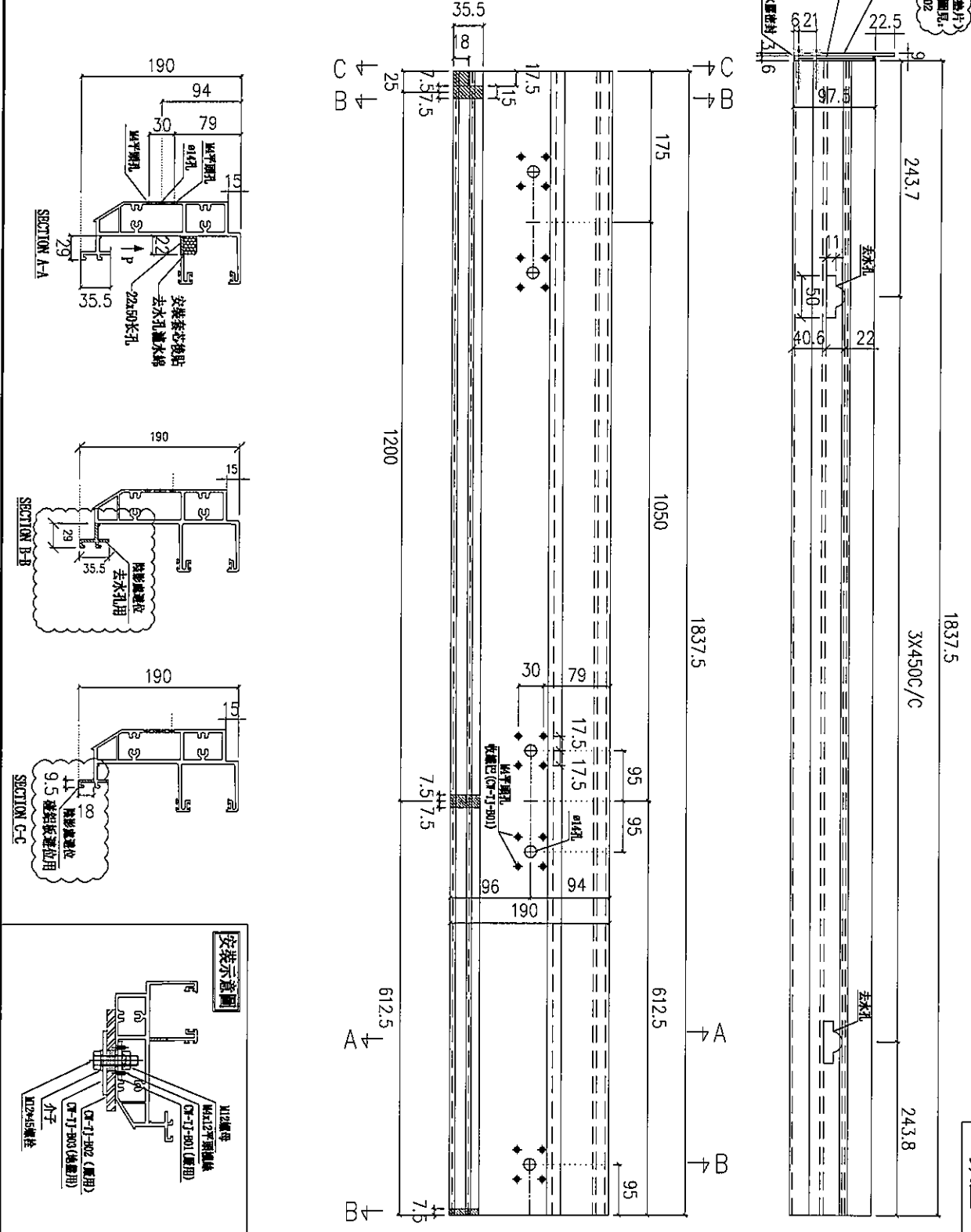

數量: 1

使用位置 J853-SD-CW-4303

名稱	頂橫	制圖	陳敏聰	2022.03.11	修改
材料	X85982	復核	謝永林	2022.03.17	日期
顏色	JMQ213457(3 coatings)	批准			圖號 J853-T3-CW-S07a



美特鋁質有限公司
MIDI Aluminium Fabricator Ltd.

工程號 J-853 地盤 延坪道

請用A3紙打印

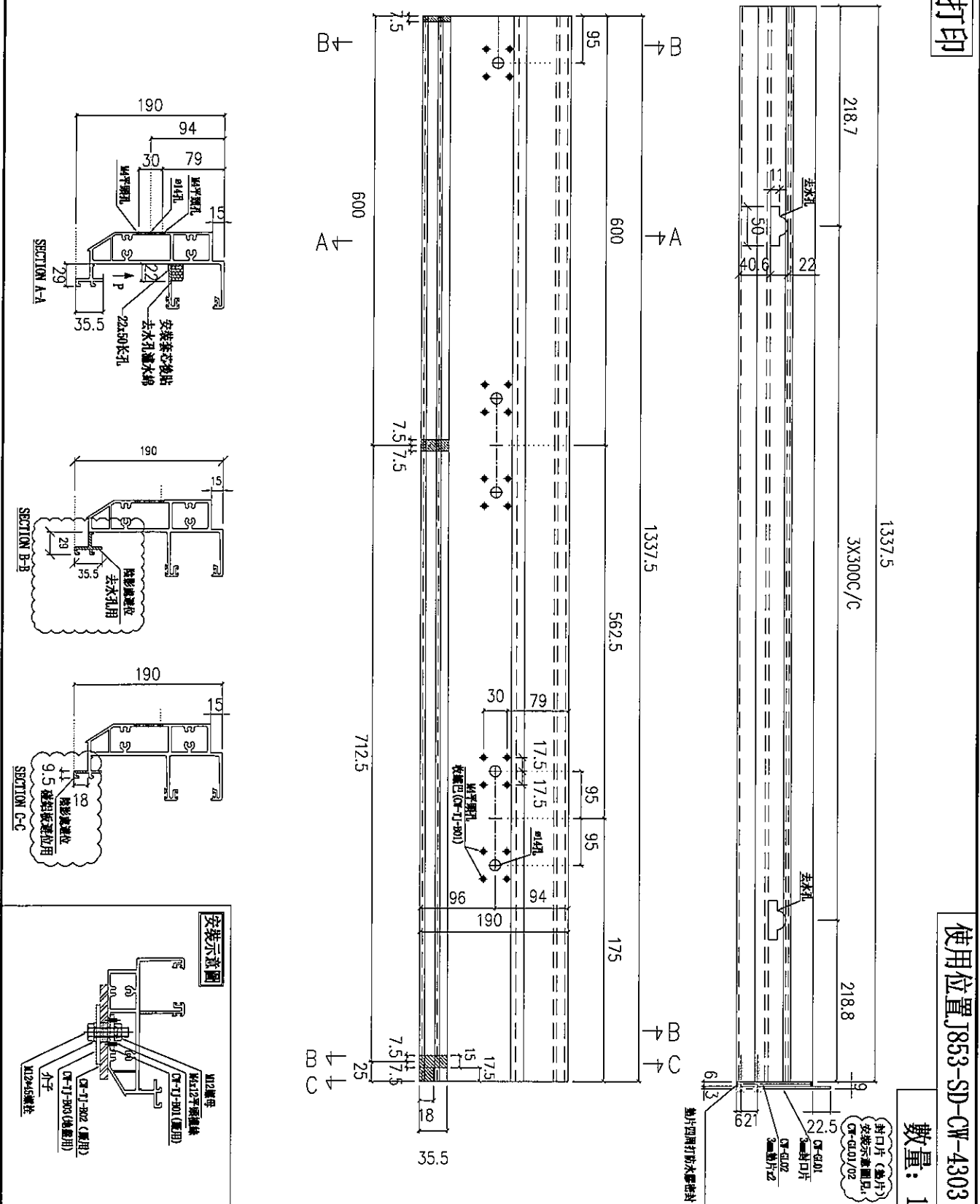

使用位置 J853-SD-CW-4303
數量: 1

名稱	頂橫	制圖	陳敏聰	2022.03.11	修改
材料	X85982	復核	謝永林	2022.03.17	日期
顏色	JMQ213457(3 coatings)	批准			圖號 J853-T3-CW-S07b

美特鋁質有限公司
MIDI Aluminium Fabricator Ltd.

工程號 J853 地盤 延坪道

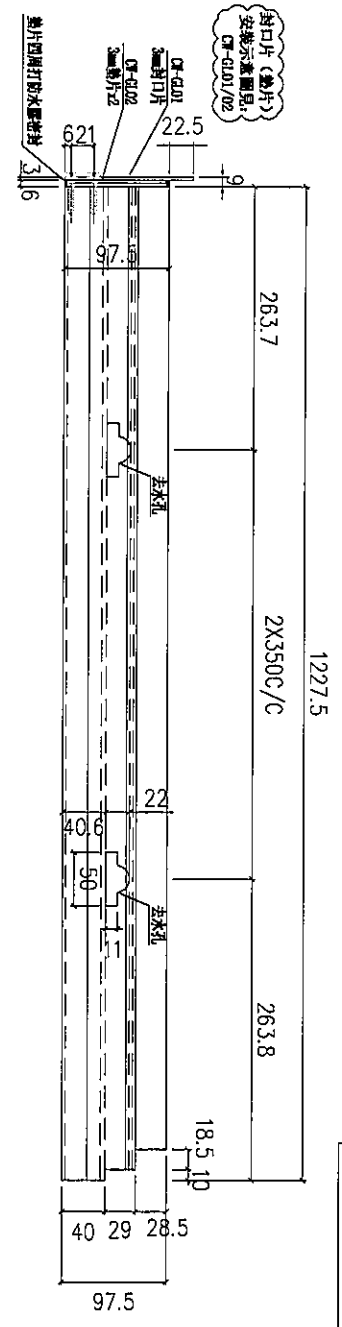
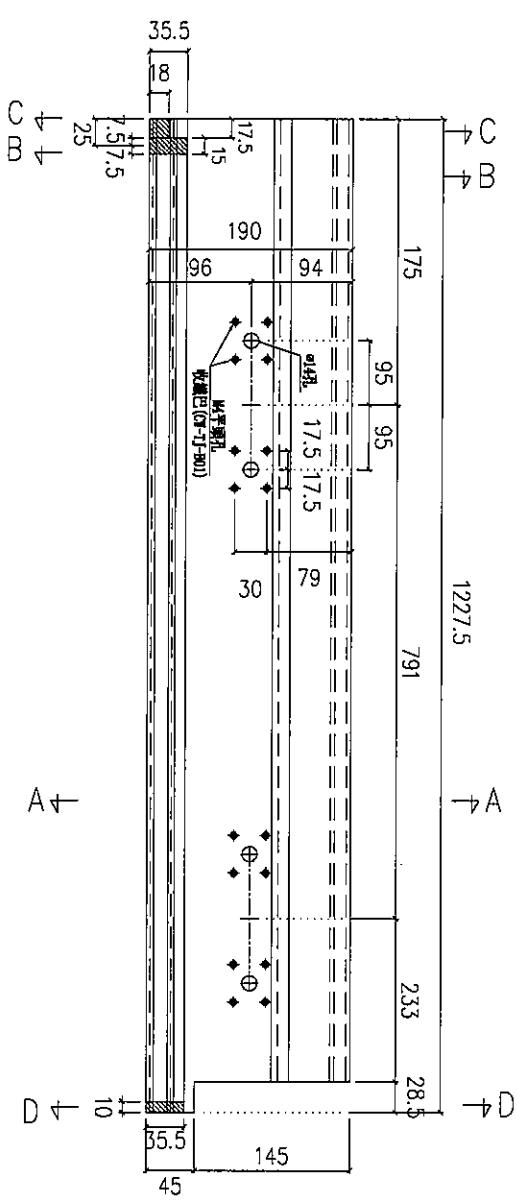
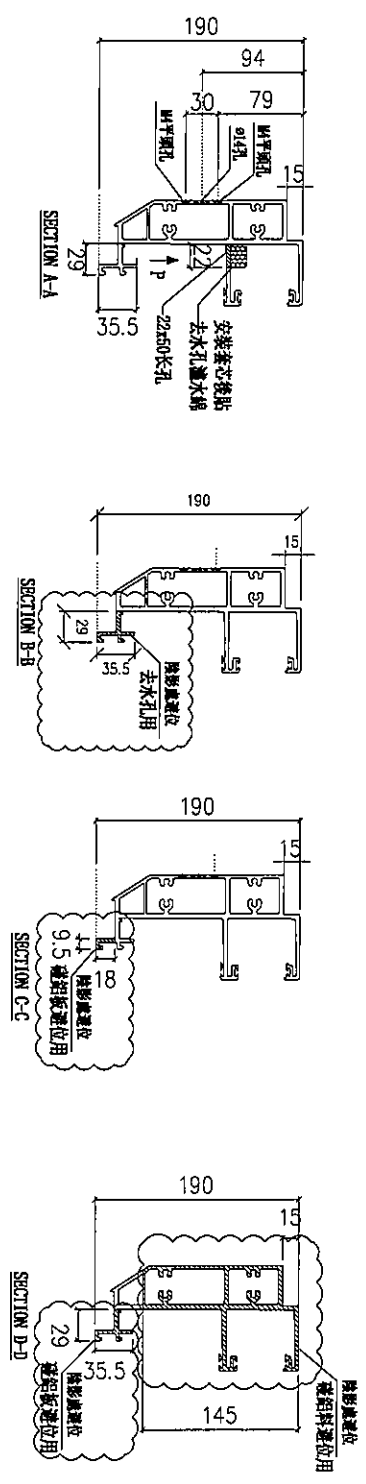

數量: 1

使用位置: J853-SD-CW-4303

名稱	頂橫	制圖	陳敏聰	2022.03.11	修改	
材料	X85982	復核	謝永林	2022.03.17	日期	
顏色	JMQ213457(3 coatings)	批准			圖號	J853-T3-CW-S08



美特鋁質有限公司
MIDI Aluminium Fabricator Ltd.

工程號 J-853 地盤 延坪道

請用A3紙打印

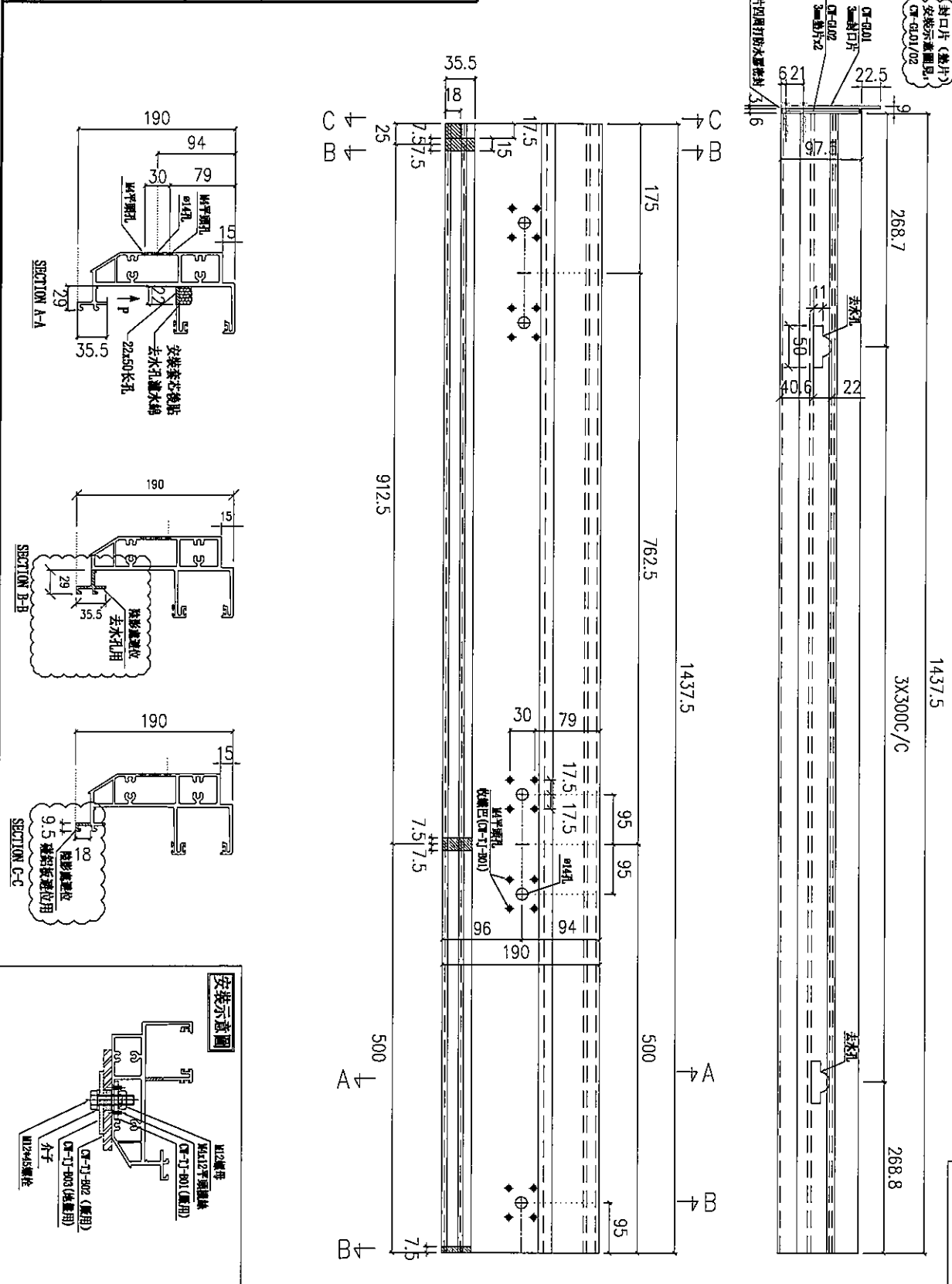

名稱	頂橫	制圖	陳敏聰	2022.03.11	修改
材料	X85982	復核	謝永林	2022.03.17	日期
顏色	JMQ213457(3 coatings)	批准			圖號 J853-T3-CW-S09a



美特鋁質有限公司
MIDI Aluminium Fabricator Ltd.

工程號 J853 地盤 延坪道

請用A3紙打印

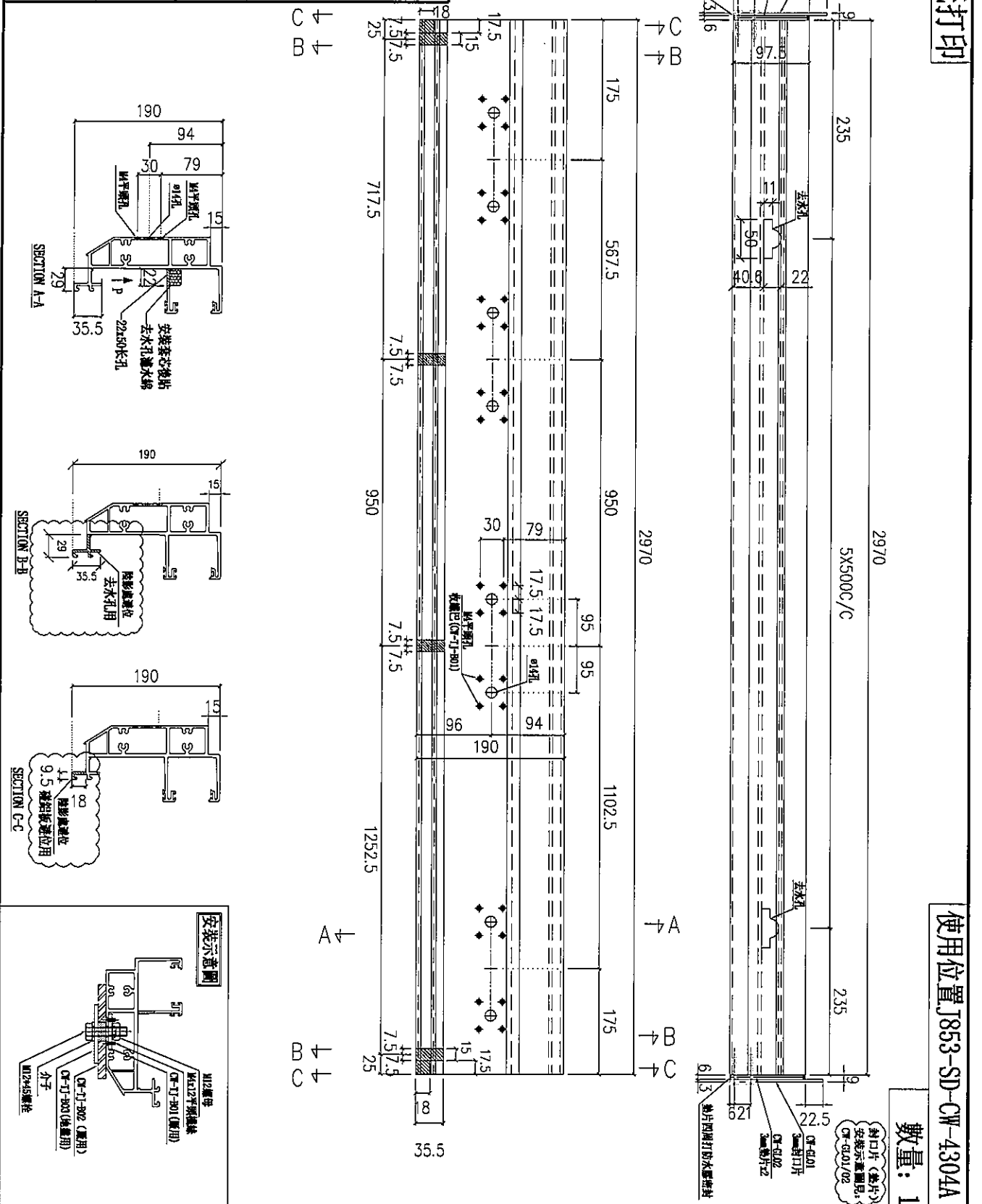

使用位置 J853-SD-CW-4304A
數量: 1

名稱	頂橫	制圖	陳敏聰	2022.03.11	修改
材料	X85982	復核	謝永林	2022.03.17	日期
顏色	JMQ213457(3 coatings)	批准			圖號 J853-T3-CW-S10

請用A3紙打印

使用位置: J853-SD-CW-4304A

數量: 1

美特鋁質有限公司
MIDI Aluminium Fabricator Ltd.

工程號	J853	地盤	延坪道
-----	------	----	-----

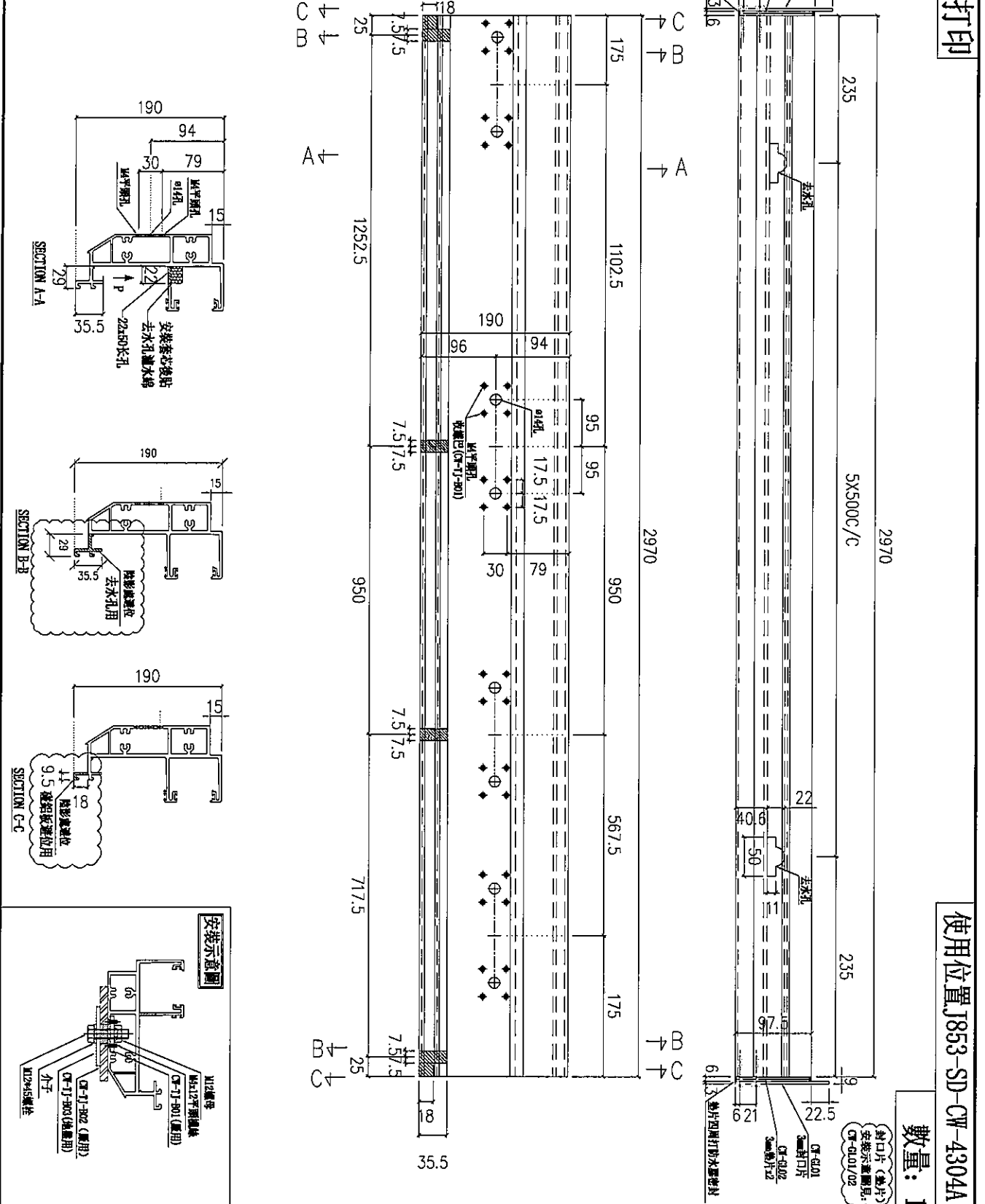

名稱	頂橫	制圖	陳敏聰	2022.03.11	修改
材料	X85982	復核	謝永林	2022.03.17	日期
顏色	JMQ213457(3 coatings)	批准			圖號
					J853-T3-CW-S11



美特鋁質有限公司
MIDI Aluminium Fabricator Ltd.

工程號 J-853 地盤 延坪道

請用A3紙打印

使用位置 J853-SD-CW-4305

數量: 1

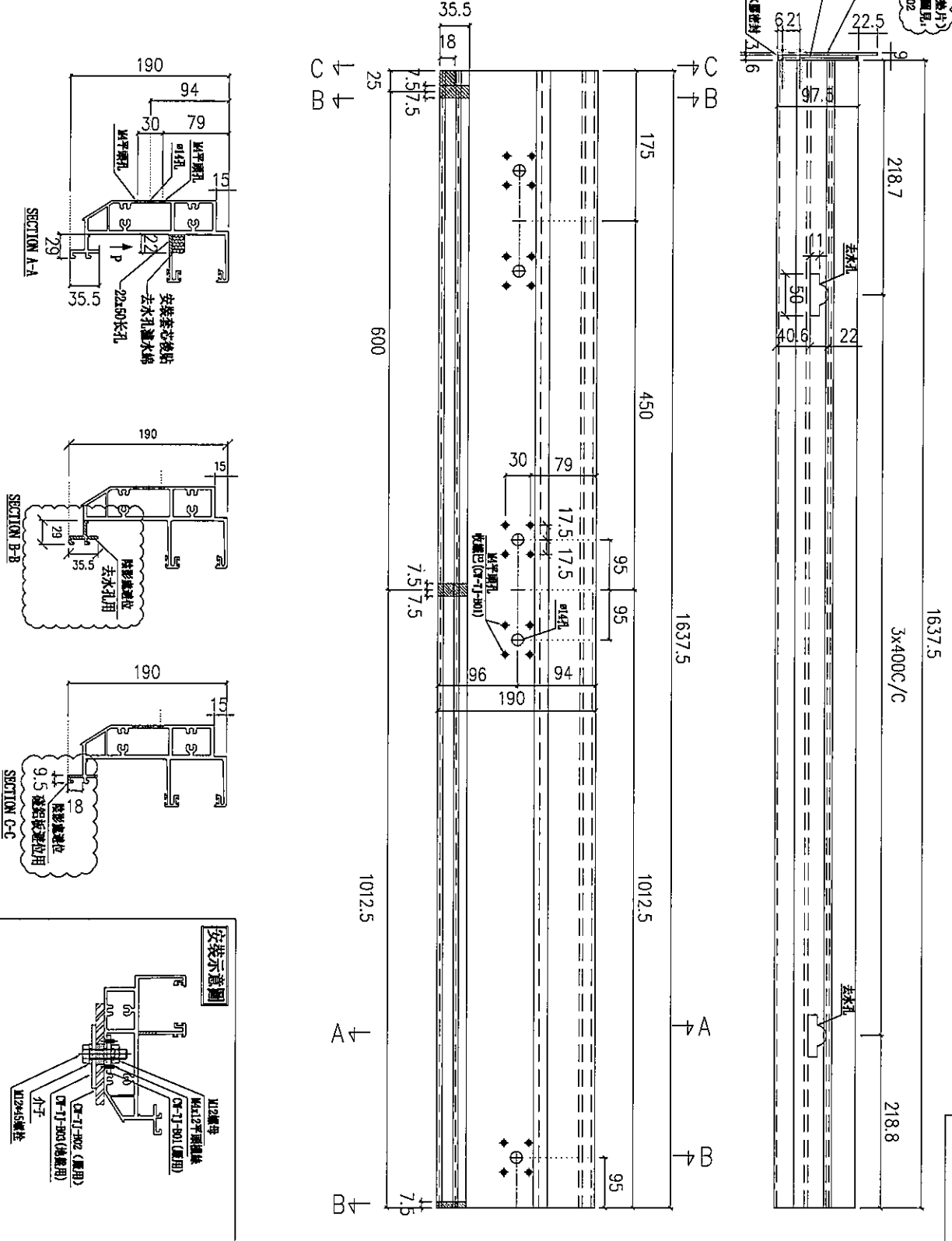

名稱	頂橫	制圖	陳敏聰	2022.03.11	修改	
材料	X85982	復核	謝永林	2022.03.17	日期	
顏色	JMQ213457(3 coatings)	批准			圖號	J853-T3-CW-S12a

請用A3紙打印

使用位置 J853-SD-CW-4305

數量: 1

美特鋁質有限公司
MIDI Aluminium Fabricator Ltd.

工程號 J-853 地盤 延坪道

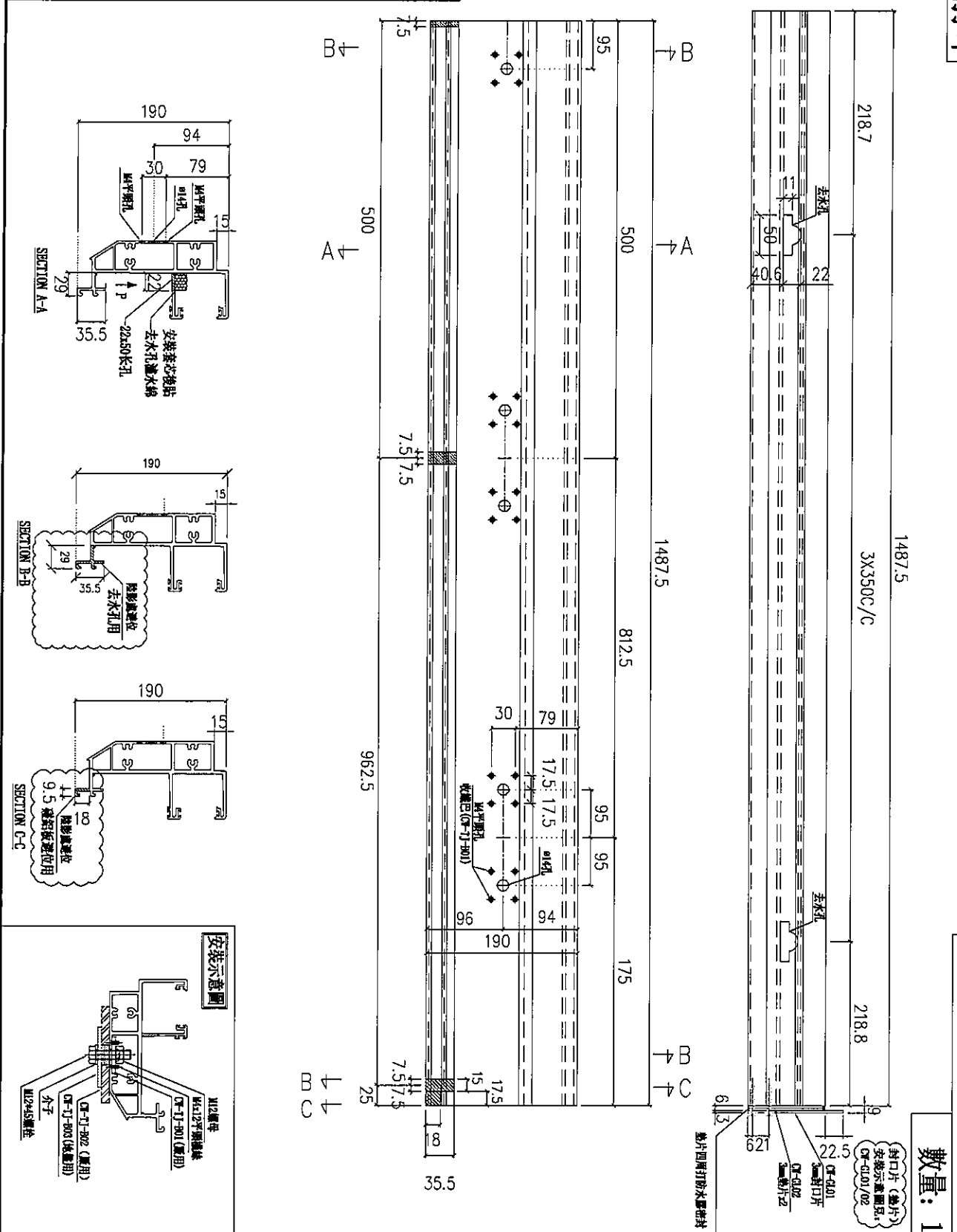

名稱	頂橫	制圖	陳敏聰	2022.03.11	修改
材料	X85982	復核	謝永林	2022.03.17	日期
顏色	JMQ213457(3 coatings)	批准			圖號 J853-T3-CW-S12b

EG-DWG3

美特鋁質有限公司
MIDI Aluminium Fabricator Ltd.

工程號 J853 地盤 延坪道

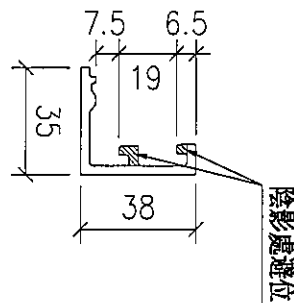

圖號	J853-T3-CW-KG01	扣蓋長度 (L)	1391	分格寬度	1400	數量	1	使用位置	J853-SD-CW-4301
----	-----------------	----------	------	------	------	----	---	------	-----------------

名稱	玻璃扣蓋	制圖	陳敏聰	2022.03.9	修改			
材料	X85989	復核	謝永林	2022.03.17	日期			
顏色	JMQ213457(3 coatings)	批准			圖號	J853-T3-CW-KG01		

EG-DWG3

 美特鋁質有限公司 MIDI Aluminium Fabricator Ltd.					
工程號	J853	地盤	延坪道		
圖號	扣蓋長度 (L)	分格寬度	數量	使用位置	
J853-T3-CW-KG03	1185	1200	1	J853-SD-CW-4301	
J853-T3-CW-KG04	1235	1250	1	J853-SD-CW-4302	
J853-T3-CW-KG05	1185	1200	1	J853-SD-CW-4302	
J853-T3-CW-KG06a	585	600	1	J853-SD-CW-4302	
J853-T3-CW-KG06b	685	700	1	J853-SD-CW-4302	
J853-T3-CW-KG07a	1185	1200	1	J853-SD-CW-4303	
J853-T3-CW-KG07b	597.5	612.5	1	J853-SD-CW-4303	
J853-T3-CW-KG07c	585	600	1	J853-SD-CW-4303	
J853-T3-CW-KG07d	697.5	712.5	1	J853-SD-CW-4303	
J853-T3-CW-KG08	1185	1200	1	J853-SD-CW-4303	
J853-T3-CW-KG09a	897.5	912.5	1	J853-SD-CW-4304	
J853-T3-CW-KG09b	485	500	1	J853-SD-CW-4304	
J853-T3-CW-KG09c	997.5	1012.5	1	J853-SD-CW-4304	
J853-T3-CW-KG09d	585	600	1	J853-SD-CW-4304	
J853-T3-CW-KG10a	702.5	717.5	1	J853-SD-CW-4304A	
J853-T3-CW-KG10b	935	950	1	J853-SD-CW-4304A	
J853-T3-CW-KG10c	1237.5	1252.5	1	J853-SD-CW-4304A	
J853-T3-CW-KG11a	1237.5	1252.5	1	J853-SD-CW-4304A	
J853-T3-CW-KG11b	935	950	1	J853-SD-CW-4304A	
J853-T3-CW-KG11c	702.5	717.5	1	J853-SD-CW-4304A	
J853-T3-CW-KG12a	585	600	1	J853-SD-CW-4305	
J853-T3-CW-KG12b	997.5	1012.5	1	J853-SD-CW-4305	
J853-T3-CW-KG12c	485	500	1	J853-SD-CW-4305	
J853-T3-CW-KG12d	947.5	962.5	1	J853-SD-CW-4305	
J853-T3-CW-KG13a	635	650	1	J853-SD-CW-4306	
J853-T3-CW-KG13b	897.5	912.5	1	J853-SD-CW-4306	
J853-T3-CW-KG13c	635	650	1	J853-SD-CW-4306	
J853-T3-CW-KG13d	1947.5	1962.5	1	J853-SD-CW-4306	
名稱	玻璃扣蓋數據表	制圖	陳敏聰	2022.03.9	修改
材料	X85989	復核	謝永林	2022.03.17	日期
顏色	JMQ213457(3 coatings)	批准			圖號 J853-T3-CW-KG03BM

EG-DWG3

美特鋁質有限公司
MIDI Aluminium Fabricator Ltd.

工程號 J853 地盤 延坪道

圖號	扣蓋長度 (L)	分格寬度	數量	使用位置
J853-T3-CW-KG02	806	815	1	J853-SD-CW-4301

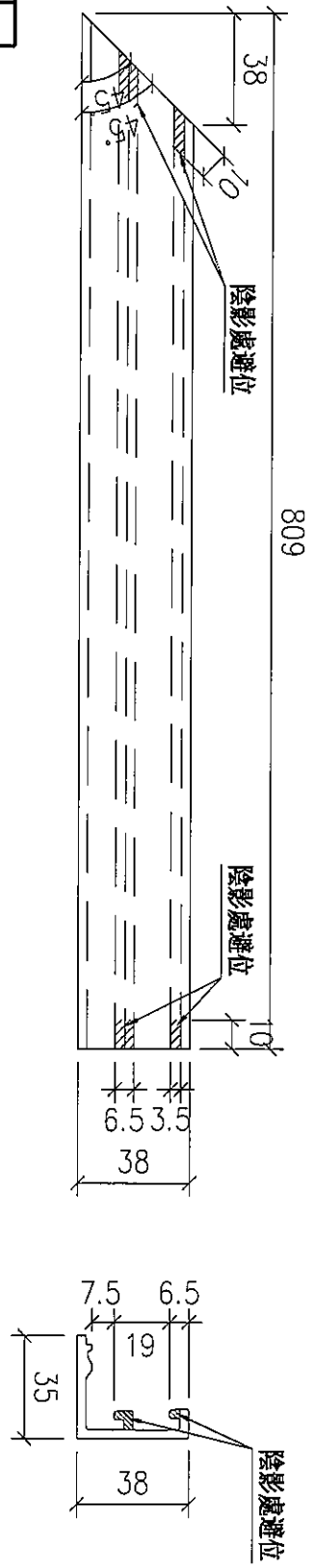

名稱	玻璃扣蓋	制圖	陳敏聰	2022.03.9	修改		
材料	X85989	復核	謝永林	2022.03.17	日期		
顏色	JMQ213457(3 coatings)	批准			圖號	J853-T3-CW-KG02	

EG-DWG3

美特鋁質有限公司
 MIDI Aluminium Fabricator Ltd.

工程號 J853 | 地盤 延坪道

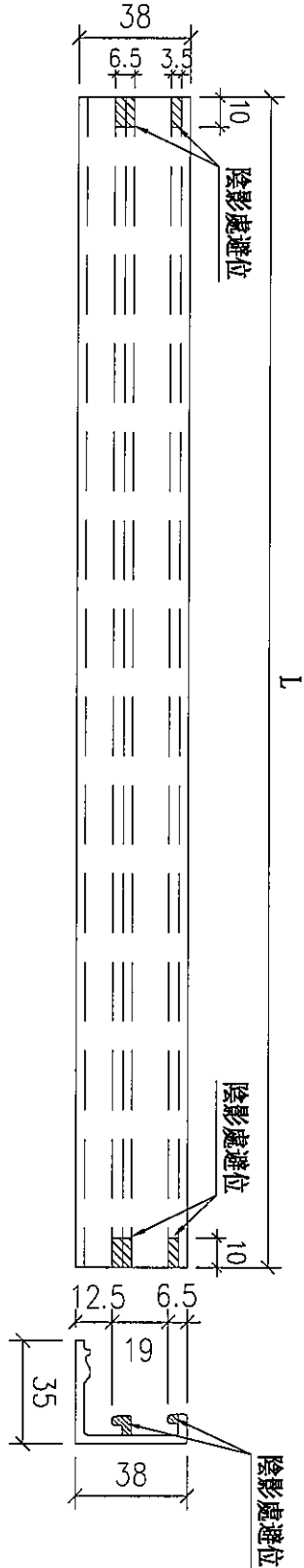

詳細數據請參考圖號
J853-T3-CW-KG03BM

名稱	玻璃扣蓋	制圖	陳敏聰	2022.03.9	修改		
材料	X85989	復核	謝永林	2022.03.17	日期		
顏色	JMQ213457(3 coatings)	批准			圖號	J853-T3-CW-KG03	

EG-DWG3

 美特鋁質有限公司 MIDI Aluminium Fabricator Ltd.							
工程號	J853	地盤	延坪道				
圖號	扣蓋長度 (L)	分格寬度	數量	使用位置			
J853-T6-CW-KG01a	585	600	1	J853-SD-CW-4601			
J853-T6-CW-KG01b	1110	1125	1	J853-SD-CW-4601			
J853-T6-CW-KG02a	1060	1075	1	J853-SD-CW-4601			
J853-T6-CW-KG02b	635	650	1	J853-SD-CW-4601			
J853-T6-CW-KG03a	627.5	642.5	1	J853-SD-CW-4602			
J853-T6-CW-KG03b	1035	1050	1	J853-SD-CW-4602			
J853-T6-CW-KG03c	1412.5	1427.5	1	J853-SD-CW-4602			
J853-T6-CW-KG04a	1412.5	1427.5	1	J853-SD-CW-4602			
J853-T6-CW-KG04b	1035	1050	1	J853-SD-CW-4602			
J853-T6-CW-KG04c	627.5	642.5	1	J853-SD-CW-4602			
J853-T6-CW-KG05a	635	650	1	J853-SD-CW-4602A			
J853-T6-CW-KG05b	1197.5	1212.5	1	J853-SD-CW-4602A			
J853-T6-CW-KG05c	585	600	1	J853-SD-CW-4602A			
J853-T6-CW-KG05d	1122.5	1137.5	1	J853-SD-CW-4602A			
J853-T6-CW-KG06	1185	1200	1	J853-SD-CW-4606			
J853-T6-CW-KG07a	1172.5	1187.5	1	J853-SD-CW-4606			
J853-T6-CW-KG07b	585	600	1	J853-SD-CW-4606			
J853-T6-CW-KG07c	585	600	1	J853-SD-CW-4606			
J853-T6-CW-KG07d	1197.5	1212.5	1	J853-SD-CW-4606			
J853-T6-CW-KG08	1185	1200	1	J853-SD-CW-4607			
J853-T6-CW-KG09a	710	725	1	J853-SD-CW-4607			
J853-T6-CW-KG09b	585	600	1	J853-SD-CW-4607			
名稱	玻璃扣蓋數據表	制圖	陳敏聰	2022.03.16	修改		
材料	X85989	復核	謝永林	2022.03.21	日期		
顏色	JMQ213457(3 coatings)	批准			圖號	J853-T6-CW-KG01BM	

BD. REF :

請用A3紙打印

SHIMAO GROUP HOLDINGS LIMITED
 ARCHITECT : WONG TUNG & PARTNERS LIMITED
WTP
 MAIN CONTRACTOR : 協興建築有限公司
HIP HING CONSTRUCTION CO LTD
 STRUCTURAL ENGINEER : C M WONG & ASSOCIATES LTD
 黃漢明建築工程師有限公司
 FACADE CONSULTANT : **MEINHARDT**

NOTE :
 1. ALL DIMENSIONS ARE IN MM.
 2. ALL ELEVATIONS ARE VIEWED FROM OUTSIDE.
 3. ALL DIMENSIONS TO BE VERIFIED ON SITE BEFORE FABRICATION.

LEGEND :
 (1) - DATE MARK NO.
 (2) - REFER SHEET NO.
 (3) - F.F.L. - FINISHED FLOOR LEVEL
 (4) - S.F.L. - STRUCTURAL FLOOR LEVEL
 (5) - R.F.L. - REVERSED DETAIL

FLOOR	LEVEL (S.F.L.)
ROOF	+470.00
26/F	+426.75
25/F	+403.45
24/F	+390.00
23/F	+376.55
22/F	+363.20
21/F	+349.75
20/F	+336.40
19/F	+323.05
18/F	+309.70
17/F	+296.35
16/F	+283.00
15/F	+269.65
14/F	+256.30
13/F	+242.95
12/F	+229.60
11/F	+216.25
10/F	+202.90
9/F	+189.55
8/F	+176.20
7/F	+162.85
6/F	+149.50
5/F	+136.15

PROJECT : PROPOSED RESIDENTIAL DEVELOPMENT AT BLK L1, 65-62 YIN PING ROAD, KOWLOON
 DRAWN BY : LHR CHECKED BY :
 DATE : 12-APR-21 SCALE : 1:50 (A1)
 SHEET NO. : J-053
 DWG NO. : JRS3-5D-CW-4601 REV. : A

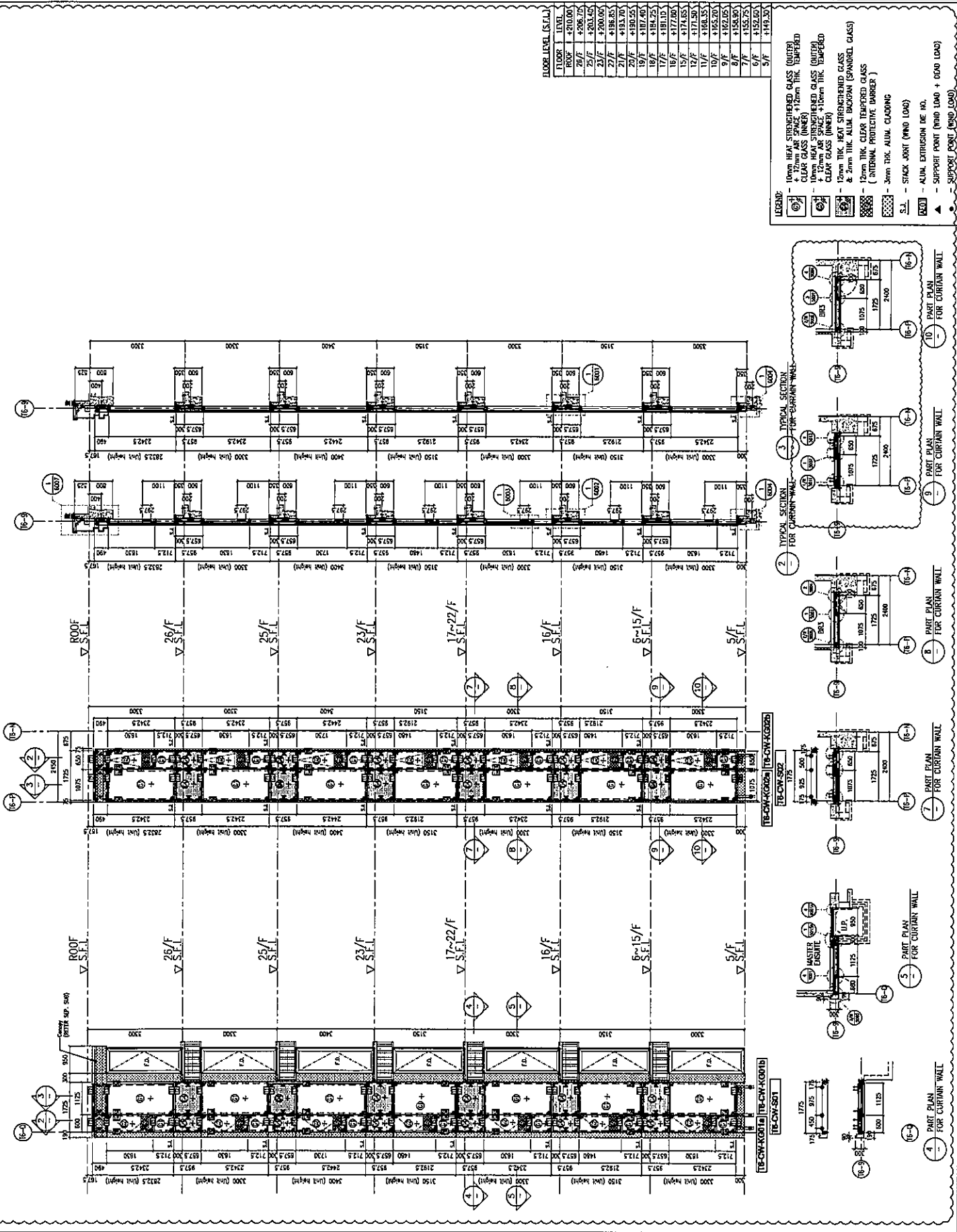

請用A3紙打印

B.I. REF :

SHIMAO GROUP HOLDINGS LIMITED

CLIENT :

ARCHITECT : **WONG TUNG & PARTNERS LIMITED**

MAIN CONTRACTOR : **協興建築有限公司 HIP HING CONSTRUCTION CO LTD**

STRUCTURAL ENGINEER : **CMA C M WONG & ASSOCIATES LTD 黃志明建築工程師有限公司**

PACKAGE CONSULTANT : **MEINHARDT**

NOTE :

1. ALL DIMENSIONS ARE IN MM.
2. ALL ELEVATIONS ARE VIEWED FROM OUTSIDE.
3. ALL DIMENSIONS TO BE VERIFIED ON SITE BEFORE FABRICATION.

LEGEND :

① - REAL MARK NO. REFER SHEET NO.

② - F.F.L. - FINISHED FLOOR LEVEL.

③ - S.F.L. - STRUCTURAL FLOOR LEVEL.

④ - REVERSED DETAIL.

⑤ - REVISION SUBJECT TO MAIN CONTRACTOR'S APPROVAL.

JOB NO. : J-853

PROJECT : PROPOSED RESIDENTIAL DEVELOPMENT AT M.L.L.L. 6542 YIM PING ROAD, KOWLOON

TITLE : PART ELEVATION FOR CURTAIN WALL AT TOWER 6 & 7

DATE : 12-APR-21 SCALE : 1:60 (A1)

DRAWN BY : LHR CHECKED BY :

MEINHARDT 美特銘實業有限公司
 MIDD ASSOCIATION ASSOCIATE LTD.
 Suite 6-4, Survey Industrial Centre, 1/F
 182-200/201-1, Tin Shui Wai, Tuen Mun
 182-200/201-1, Tin Shui Wai, Tuen Mun

FIG. NO. : J853-S0-CW-4602 REV. : A

FLOOR LEVEL (S.F.L.)	LEVEL
ROOF	+210.00
26/F	+206.70
25/F	+203.40
24/F	+200.00
23/F	+196.65
22/F	+193.20
21/F	+189.85
20/F	+186.50
19/F	+183.15
18/F	+179.80
17/F	+176.45
16/F	+173.10
15/F	+169.75
14/F	+166.40
13/F	+163.05
12/F	+159.70
11/F	+156.35
10/F	+153.00
9/F	+149.65
8/F	+146.30
7/F	+142.95
6/F	+139.60
5/F	+136.25

- LEGEND :
- ① 10mm HEAT STRENGTHENED GLASS (OUTER) + 12mm AIR SPACE + 12mm THK. UNLEADED CLEAR GLASS (INNER)
 - ② 10mm HEAT STRENGTHENED GLASS (OUTER) + 12mm AIR SPACE + 10mm THK. UNLEADED CLEAR GLASS (INNER)
 - ③ 12mm THK. HEAT STRENGTHENED GLASS & 2mm THK. ALUM. BACKPAN (SPANNING GLASS)
 - ④ 12mm THK. CLEAR TEMPERED GLASS (INTERNAL PROTECTIVE BARBER)
 - ⑤ 3mm THK. ALUM. CLADDING
 - S.L. - STACK JOINT (WIND LOAD)
 - ⑥ ALUM. EXTENSION BE. NO.
 - ⑦ SUPPORT POINT (WIND LOAD + DEAD LOAD)
 - ⑧ SUPPORT POINT (WIND LOAD)

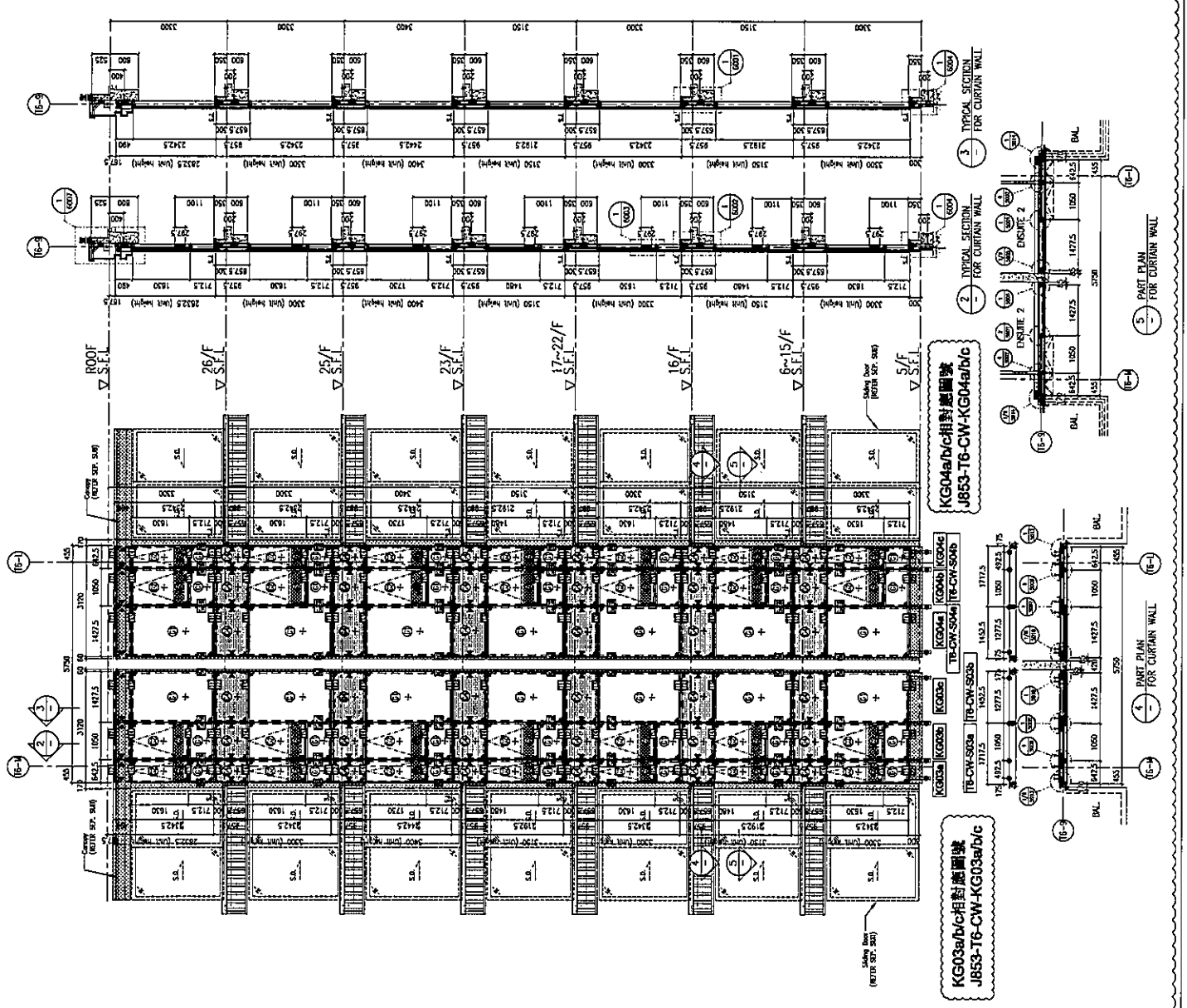

請用A3紙打印

SHIMAO GROUP HOLDINGS LIMITED
 ARCHITECT: WONG TUNG & PARTNERS LIMITED

MAIN CONTRACTOR: 協興建築有限公司
 HP HING CONSTRUCTION CO LTD

STRUCTURAL ENGINEER: C M HONG & ASSOCIATES LTD
 香港測量師工程師有限公司

FAÇADE CONSULTANT: MEINHARDT

NOTE:
 1. ALL DIMENSIONS ARE IN MM.
 2. ALL ELEVATIONS ARE VIEWED FROM OUTSIDE.
 3. ALL DIMENSIONS TO BE VERIFIED ON SITE BEFORE FABRICATION.

LEGEND:
 (A) - DECK MARK NO.
 (B) - RETER SHEET NO.

1. F.F.L. - FINISHED FLOOR LEVEL
 2. S.F.L. - STRUCTURAL FLOOR LEVEL
 3. (R) - REVERSED DEVAL

PROJECT: PROPOSED RESIDENTIAL DEVELOPMENT AT 11, ALL 65-62 YIK PING ROAD, KOWLOON

TITLE: PART ELEVATION FOR CURTAIN WALL AT TOWER 6 & 7

DATE: 24-OCT-21 SCALE: 1:60 (A1)

DRAWN BY: LHR CHECKED BY:

美特銘有限公司
 MIDDI Architecture Associates Ltd.
 110 Cheung Yee Road, Tsimshatsui, Kowloon
 TEL: (852) 27777666
 FING. NO.: 3853-SJ-CW-4602A REV.: A

FLOOR LEVEL (S.F.L.)	LEVEL
ROOF	+270.00
26/F	+266.70
25/F	+263.40
23/F	+260.10
22/F	+256.80
21/F	+253.50
20/F	+250.20
19/F	+246.90
18/F	+243.60
17/F	+240.30
16/F	+237.00
15/F	+233.70
14/F	+230.40
13/F	+227.10
12/F	+223.80
11/F	+220.50
10/F	+217.20
9/F	+213.90
8/F	+210.60
7/F	+207.30
6/F	+204.00
5/F	+200.70

- LEGEND:
- 10mm HEAT STRENGTHENED GLASS (OUTER)
 - 12mm CLEAR GLASS (INNER)
 - 12mm HEAT STRENGTHENED GLASS (OUTER)
 - 12mm CLEAR GLASS (INNER)
 - 12mm HEAT STRENGTHENED GLASS (OUTER) & 2mm THK ALUM. BACKUP (SPANDREL GLASS)
 - 12mm HEAT STRENGTHENED GLASS (OUTER) & 2mm THK ALUM. BACKUP (SPANDREL GLASS) (INTERNAL PROTECTIVE BARBER)
 - 3mm THK ALUM. CLADDING
 - S.L. - STACK JOINT (WIND LOAD)
 - ALUM. EXTENSION DE. NO.
 - SUPPORT POINT (WIND LOAD + DEAD LOAD)
 - SUPPORT POINT (WIND LOAD)

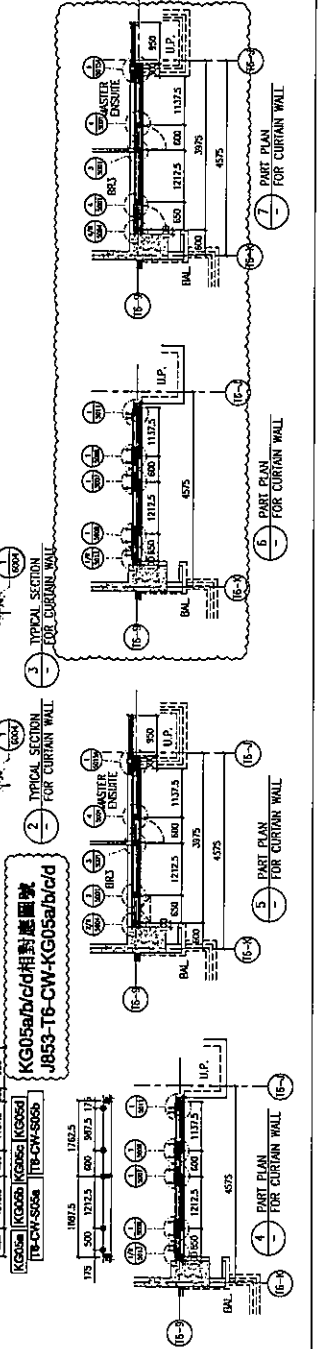
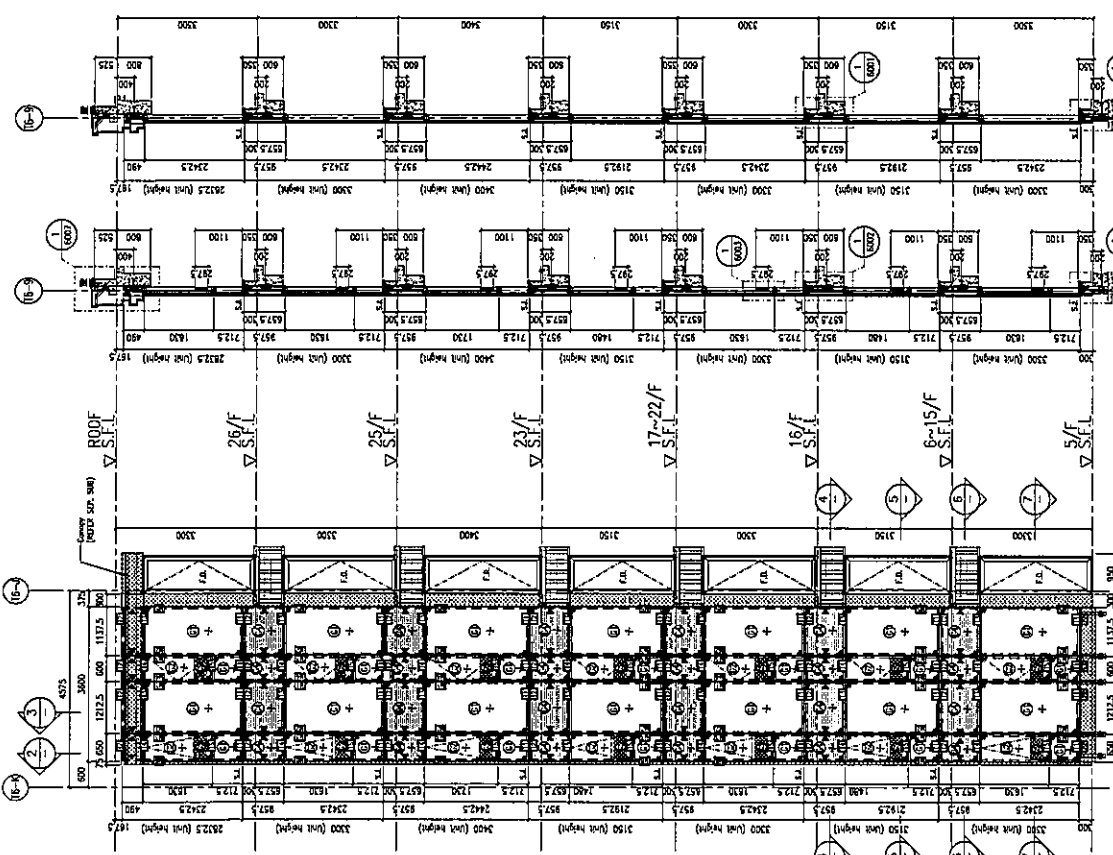

圖號: [KG05ab/c/d] 相對圖號: [J853-T6-CW-KG05ab/c/d]

圖號: [TG-CW-S906] [TG-CW-S908]

B.O. REF :

請用A3紙打印

SHIMAO GROUP HOLDINGS LIMITED
 新加坡新加坡有限公司
 SHIMAO GROUP HOLDINGS LIMITED

HP HING CONSTRUCTION CO LTD
 新加坡新加坡有限公司
 HP HING CONSTRUCTION CO LTD

CMW CM WONG & ASSOCIATES LTD
 新加坡新加坡有限公司
 CMW CM WONG & ASSOCIATES LTD

MEINHARDT
 新加坡新加坡有限公司
 MEINHARDT

NOTE:
 1. ALL DIMENSIONS ARE IN MM.
 2. ALL ELEVATIONS ARE VIEWED FROM OUTSIDE.
 3. ALL DIMENSIONS TO BE VERIFIED ON SITE BEFORE FABRICATION.

LEGEND:
 (S) - RETAIN MARK NO.
 (R) - REFER SHEET NO.
 1. F.F.L. - FINISHED FLOOR LEVEL.
 2. S.F.L. - STRUCTURAL FLOOR LEVEL.
 3. (R) - REVERSED DENOTE.

PROJECT: PROPOSED RESIDENTIAL DEVELOPMENT AT N.K.L.L. 6542, 7th FLOOR, 7th FLOOR, KUALA LUMPUR.

DATE: 13-APR-21
SCALE: 1:60 (A1)
DRAWN BY: LHR
CHECKED BY: [Signature]
DATE: 13-APR-21
SCALE: 1:60 (A1)
DRAWN BY: LHR
CHECKED BY: [Signature]

PROJECT: PROPOSED RESIDENTIAL DEVELOPMENT AT N.K.L.L. 6542, 7th FLOOR, 7th FLOOR, KUALA LUMPUR.

DATE: 13-APR-21
SCALE: 1:60 (A1)
DRAWN BY: LHR
CHECKED BY: [Signature]

PROJECT: PROPOSED RESIDENTIAL DEVELOPMENT AT N.K.L.L. 6542, 7th FLOOR, 7th FLOOR, KUALA LUMPUR.

DATE: 13-APR-21
SCALE: 1:60 (A1)
DRAWN BY: LHR
CHECKED BY: [Signature]

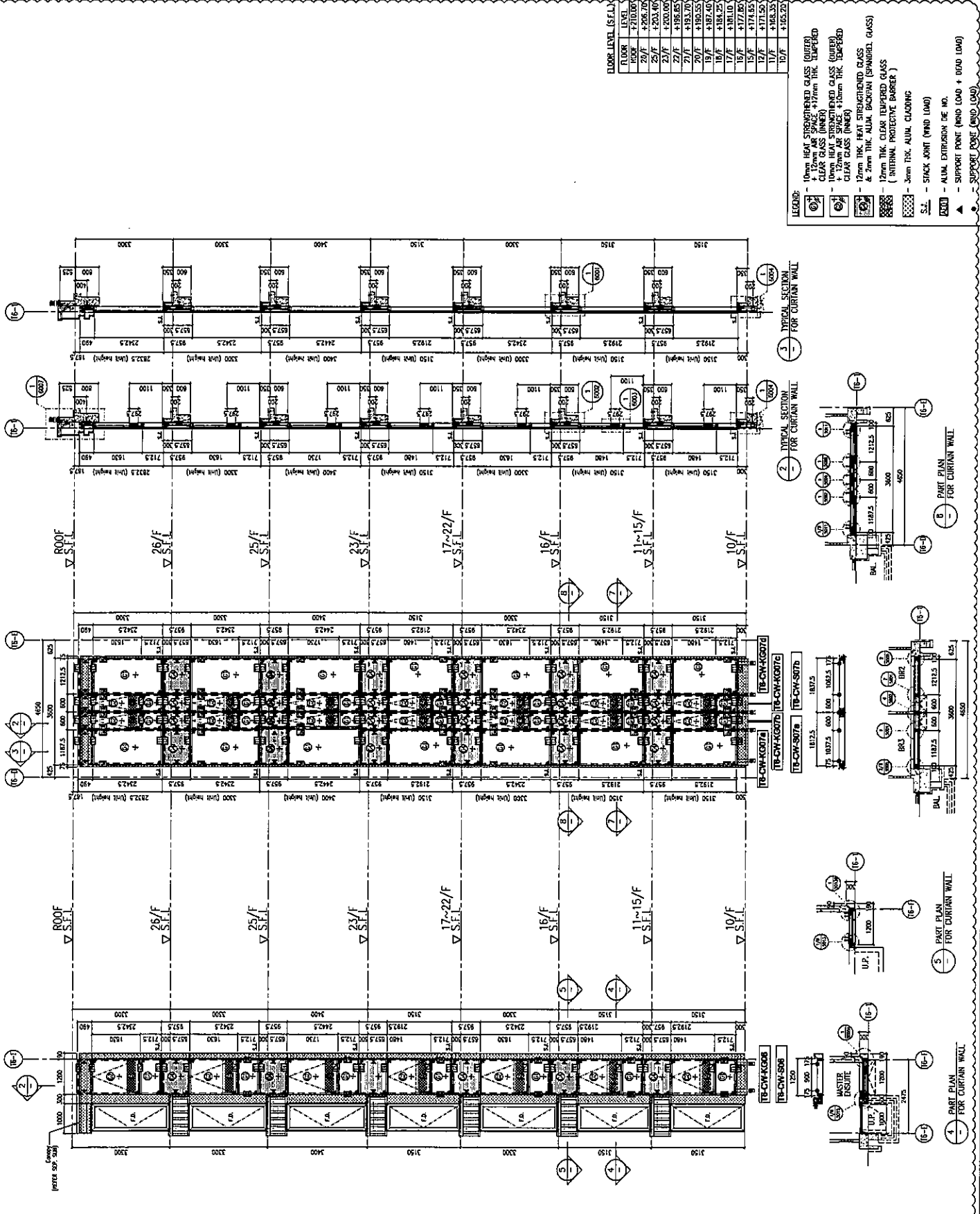

B.D. REF :

請用A3紙打印

CLIENT : SHIMAD GROUP HOLDINGS LIMITED

ARCHITECT : WONG TUNG & PARTNERS LIMITED



MAIN CONTRACTOR : 協興建築有限公司 HOP HING CONSTRUCTION CO. LTD

STRUCTURAL ENGINEER : C.M.A. C.M. WONG & ASSOCIATES LTD 黃志輝建築工程師有限公司

FRAME CONSULTANT : MEINHARDT

NOTE: 1. ALL DIMENSIONS ARE IN DIM. 2. ALL DIMENSIONS ARE VIEWED FROM OUTSIDE. 3. ALL DIMENSIONS TO BE VERIFIED ON SITE BEFORE FABRICATION.

LEGEND: 1. NETAL MARK NO. 2. REFER SHEET NO.

LEGEND: 1. F.F.L. — FINISHED FLOOR LEVEL. 2. S.F.L. — STRUCTURAL FLOOR LEVEL. 3. (R) — REVERSED DETAIL.

PROJECT : PROPOSED RESIDENTIAL DEVELOPMENT AT 11, L.L. 65-42 YIN PING ROAD KOWLOON

TITLE : PART ELEVATION FOR CURTAIN WALL AT TOWER 6 & 7

DATE : 13-APR-21 SCALE : 1:60 (A1)

DRAWN BY : LHR CHECKED BY : 美特鋁業有限公司 MIDAL Aluminium Fabrication Ltd. 110 Cheong Yee Road, Kowloon HONGKONG TEL: (852) 27277666 PWC NO. : J053-50-CW-4607 REV. : A

FLOOR LEVEL (S.F.L.)	LEVEL
26/F	+210.00
25/F	+200.00
24/F	+200.00
23/F	+190.00
22/F	+180.00
21/F	+180.00
20/F	+180.00
19/F	+180.00
18/F	+180.00
17/F	+180.00
16/F	+177.20
15/F	+177.20
14/F	+177.20
13/F	+177.20
12/F	+177.20
11/F	+177.20
10/F	+165.20

- LEGEND:
- 10mm HEAT STRENGTHENED GLASS (INNER) + 12mm AIR SPACE + 12mm THK. TEMPERED CLEAR GLASS (INNER)
 - 10mm HEAT STRENGTHENED GLASS (OUTER) + 12mm AIR SPACE + 10mm THK. TEMPERED CLEAR GLASS (INNER)
 - 12mm THK. HEAT STRENGTHENED GLASS & 2mm THK. ALUM. BACKING (SPANNER GLASS)
 - 12mm THK. CLEAR TEMPERED GLASS (INTERNAL PROTECTIVE BARBER)
 - 3mm THK. ALUM. CLADDING
 - S.J. — STACK JOINT (WIND LOAD)
 - ALUM. EXTENSION BE. HO.
 - SUPPORT POINT (WIND LOAD + 0.04D LOAD)
 - SUPPORT ROBE (WIND LOAD)

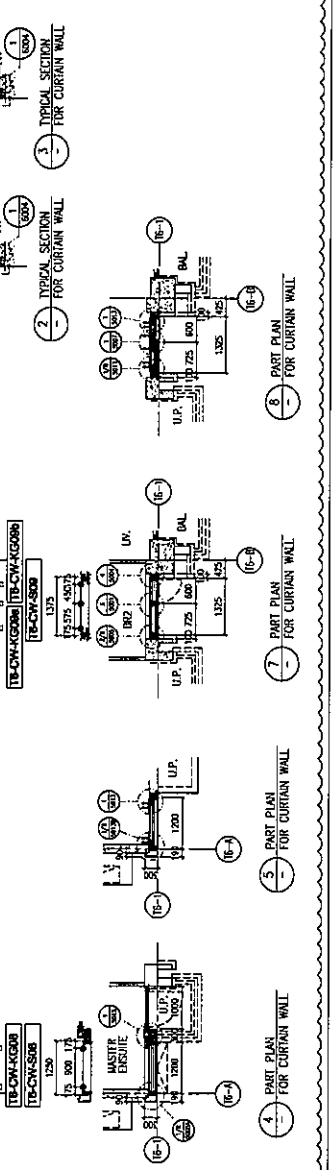
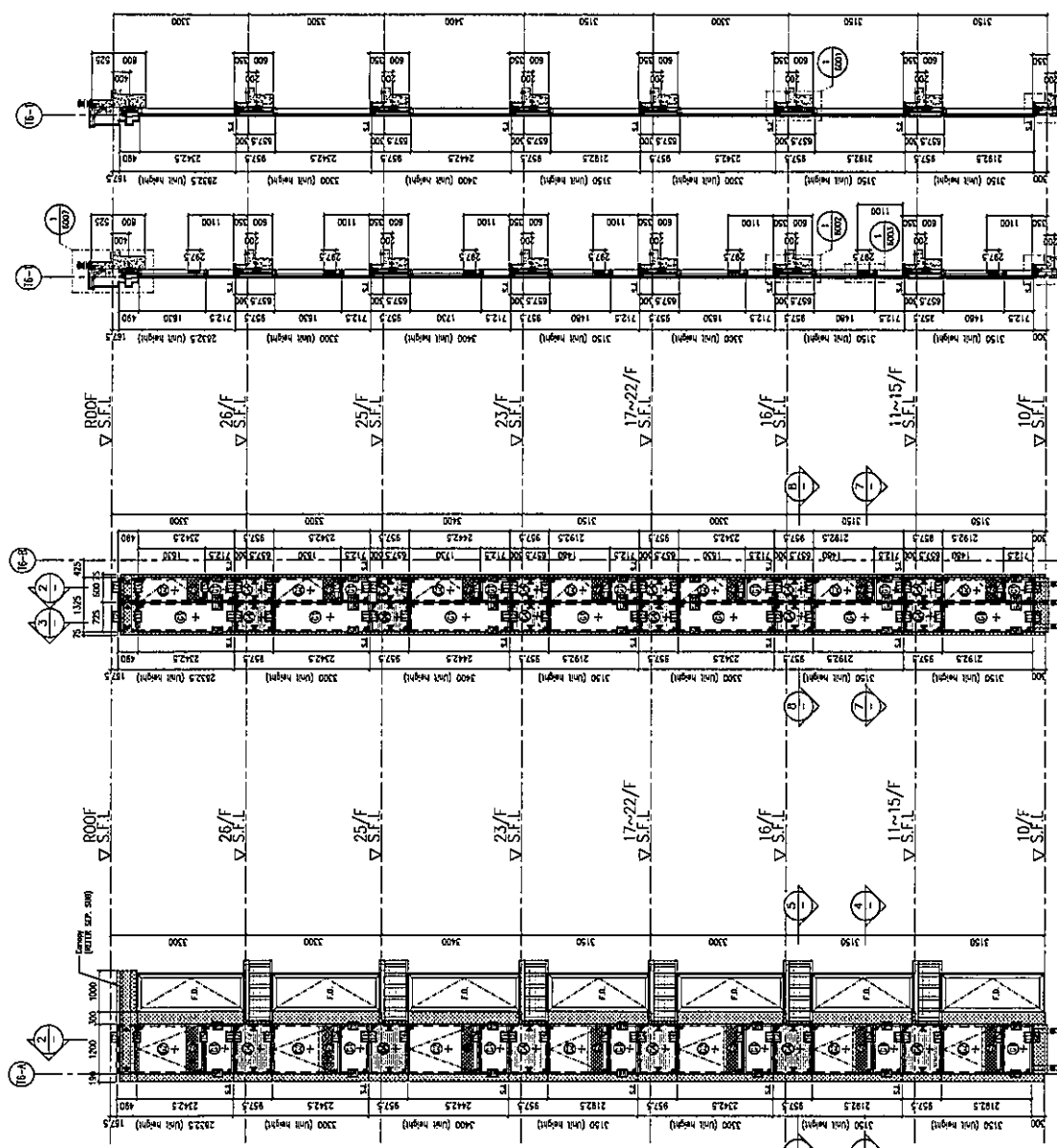



美特鋁質有限公司
MIDI Aluminium Fabricator Ltd.

工程號 J853 地盤 延坪道

請用A3紙打印

使用位置 J853-SD-CW-4601

數量: 1

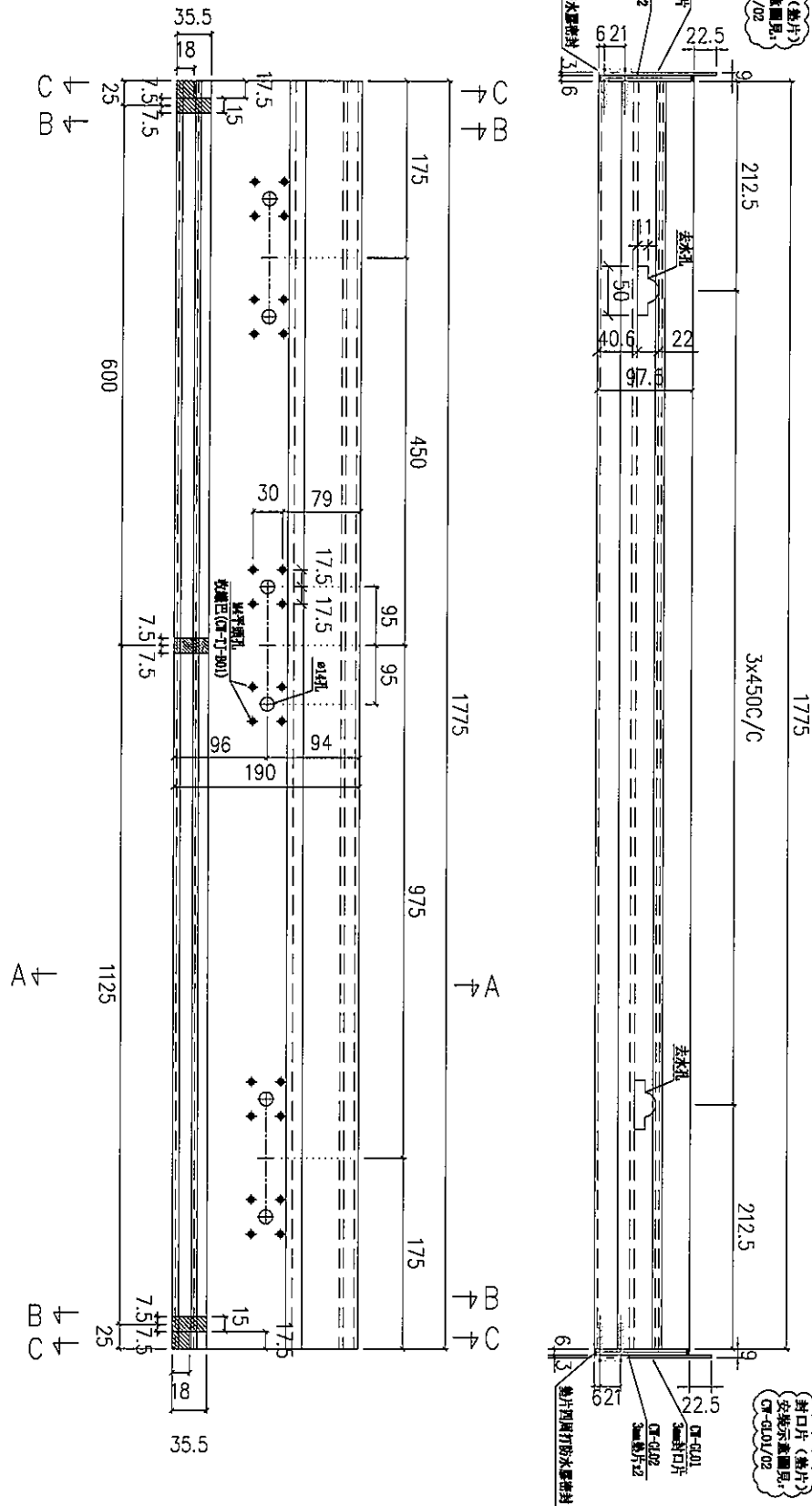

名稱	頂橫	制圖	陳敏聰	2022.03.11	修改
材料	X85982	復核	謝永林	2022.03.21	日期
顏色	JMQ213457(3 coatings)	批准			圖號 J853-T6-CW-S01

請用A3紙打印

使用位置 J853-SD-CW-4601

數量: 1

封口片 (黏片)
安裝示意圖見:
CW-G01/02

封口片 (黏片)
安裝示意圖見:
CW-G01/02

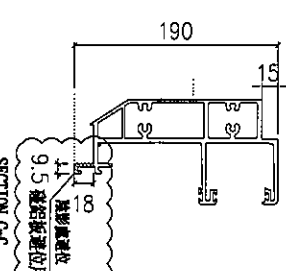
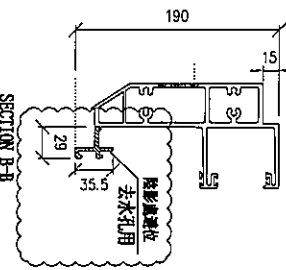
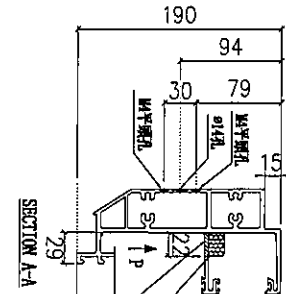
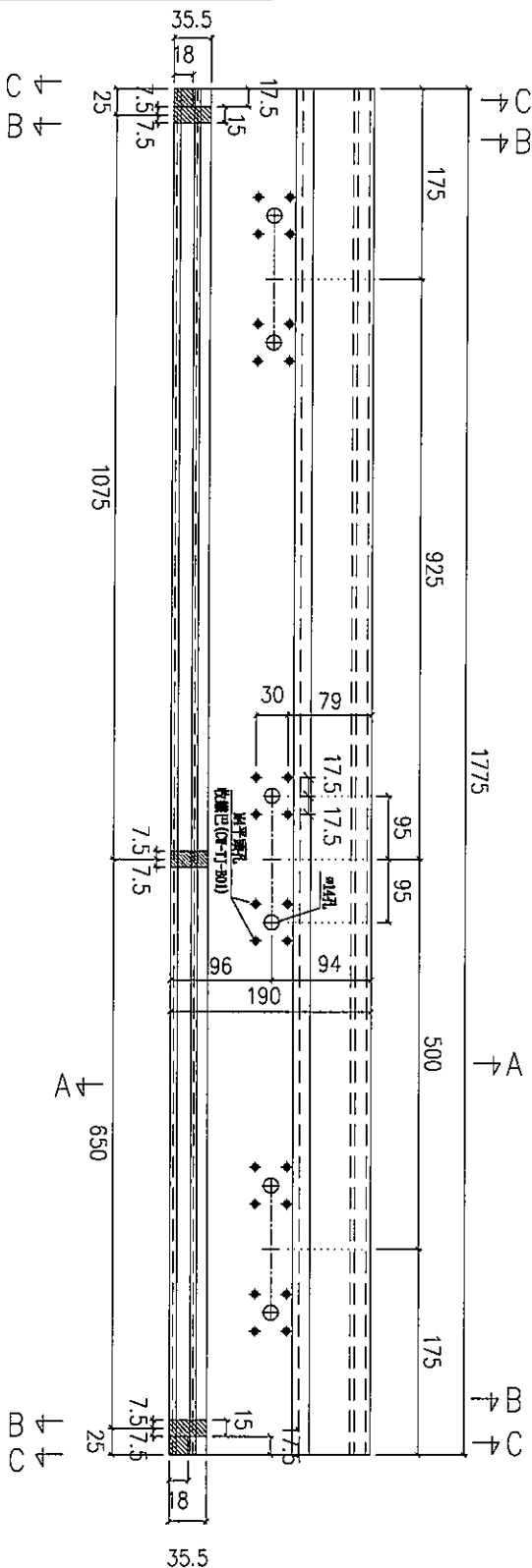
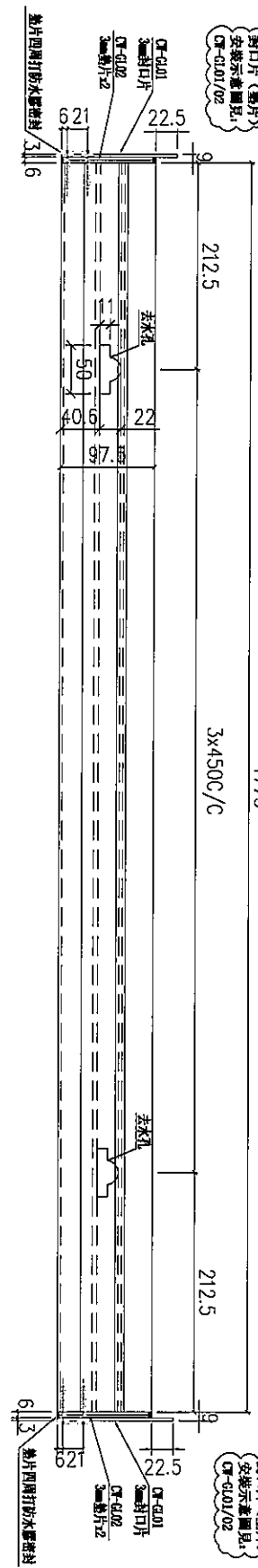

安裝示意圖

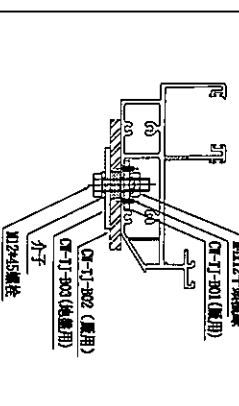

名稱	頂橫	制圖	陳敏聰	2022.03.11	修改
材料	X85982	復核	謝永林	2022.03.21	日期
顏色	JMQ213457(3 coatings)	批准			圖號 J853-T6-CW-S02

美特鋁質有限公司
MIDI Aluminium Fabricator Ltd.

工程號 J853 地盤 延坪道

請用A3紙打印

使用位置 J853-SD-CW-4602

數量: 1

封口片 (裝片)
安裝示意圖見
DW-610/02

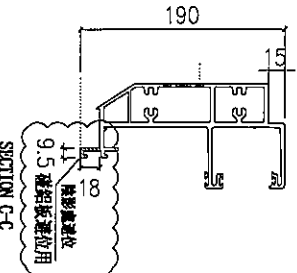
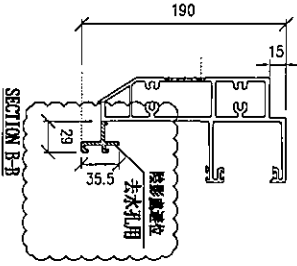
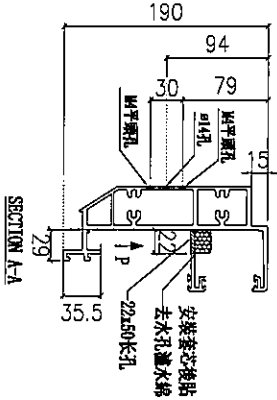
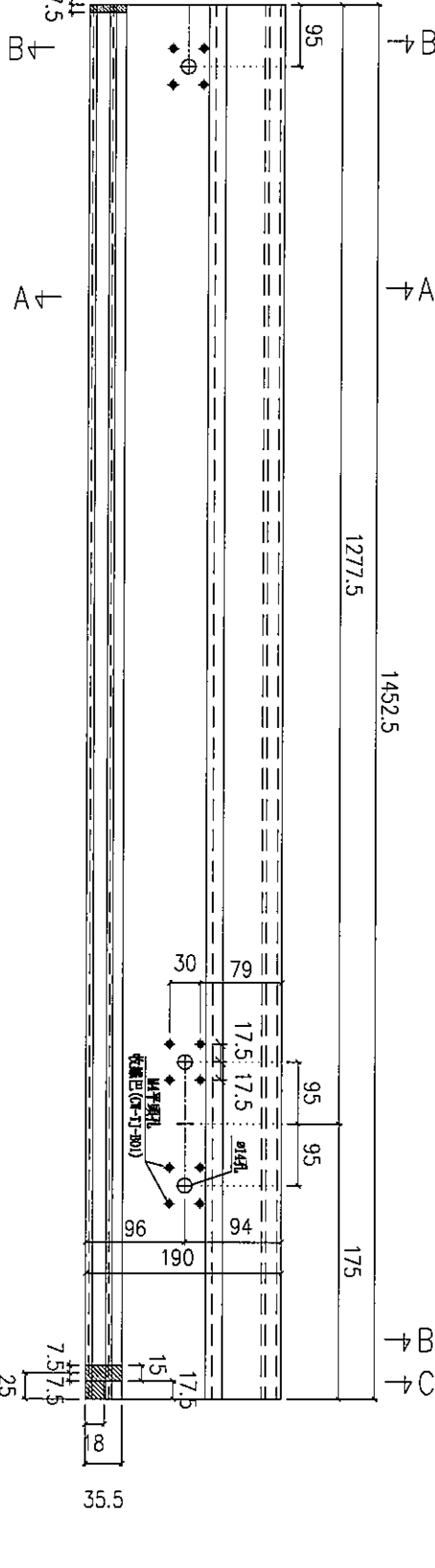
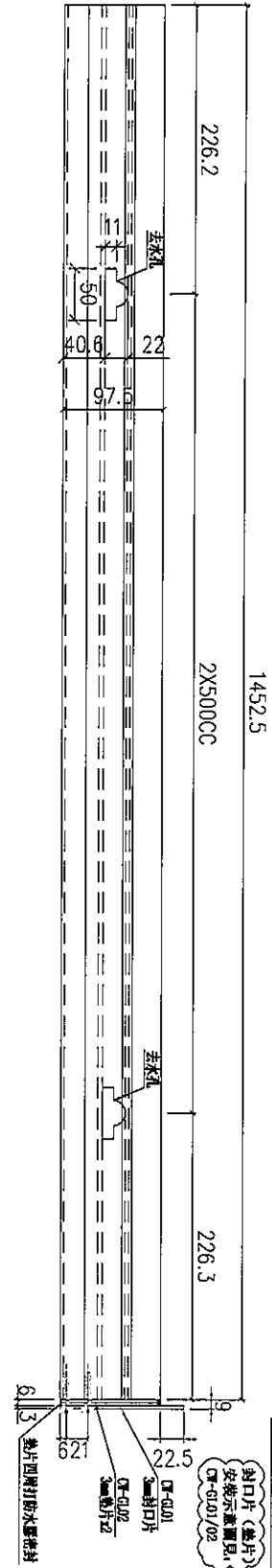

安裝示意圖

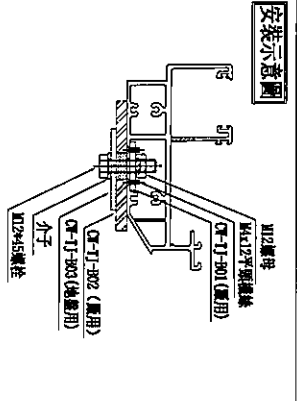

美特鋁質有限公司
MIDI Aluminium Fabricator Ltd.

工程號 J853 地盤 延坪道

名稱	頂橫	制圖	陳敏聰	2022.03.11	修改		
材料	X85982	復核	謝永林	2022.03.21	日期		
顏色	JMQ213457(3 coatings)	批准			圖號	J853-T6-CW-S03b	

美特鋁質有限公司
MIDI Aluminium Fabricator Ltd.

工程號	J853	地盤	延坪道
-----	------	----	-----

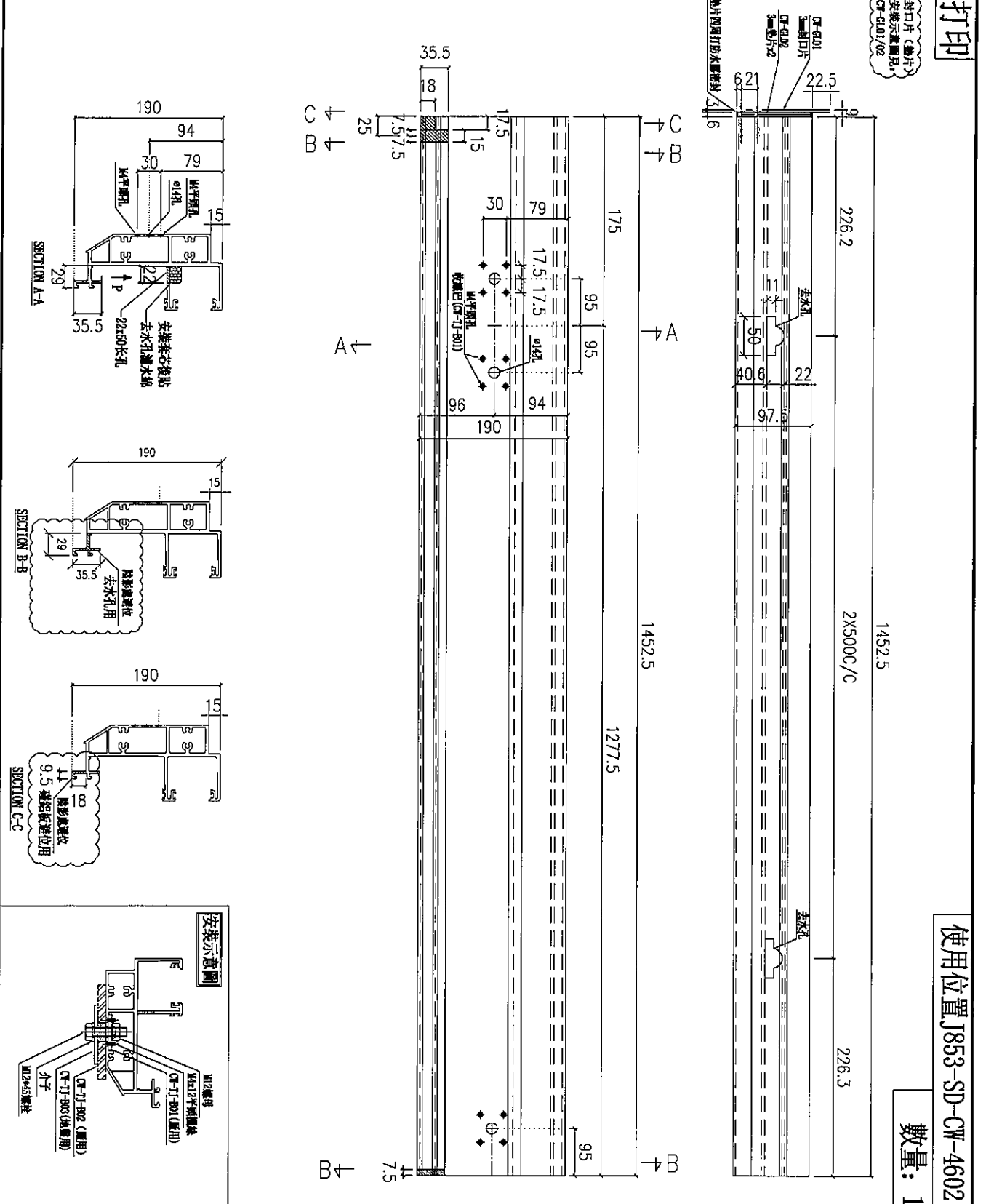

名稱	頂橫	制圖	陳敏聰	2022.03.11	修改
材料	X85982	復核	謝永林	2022.03.21	日期
顏色	JMQ213457(3 coatings)	批准			圖號
					J853-T6-CW-S04a

數量: 1

封口片 (墊片)
安裝示意圖見
CW-6101/02

美特鋁質有限公司
MIDI Aluminium Fabricator Ltd.

工程號 J853 地盤 延坪道

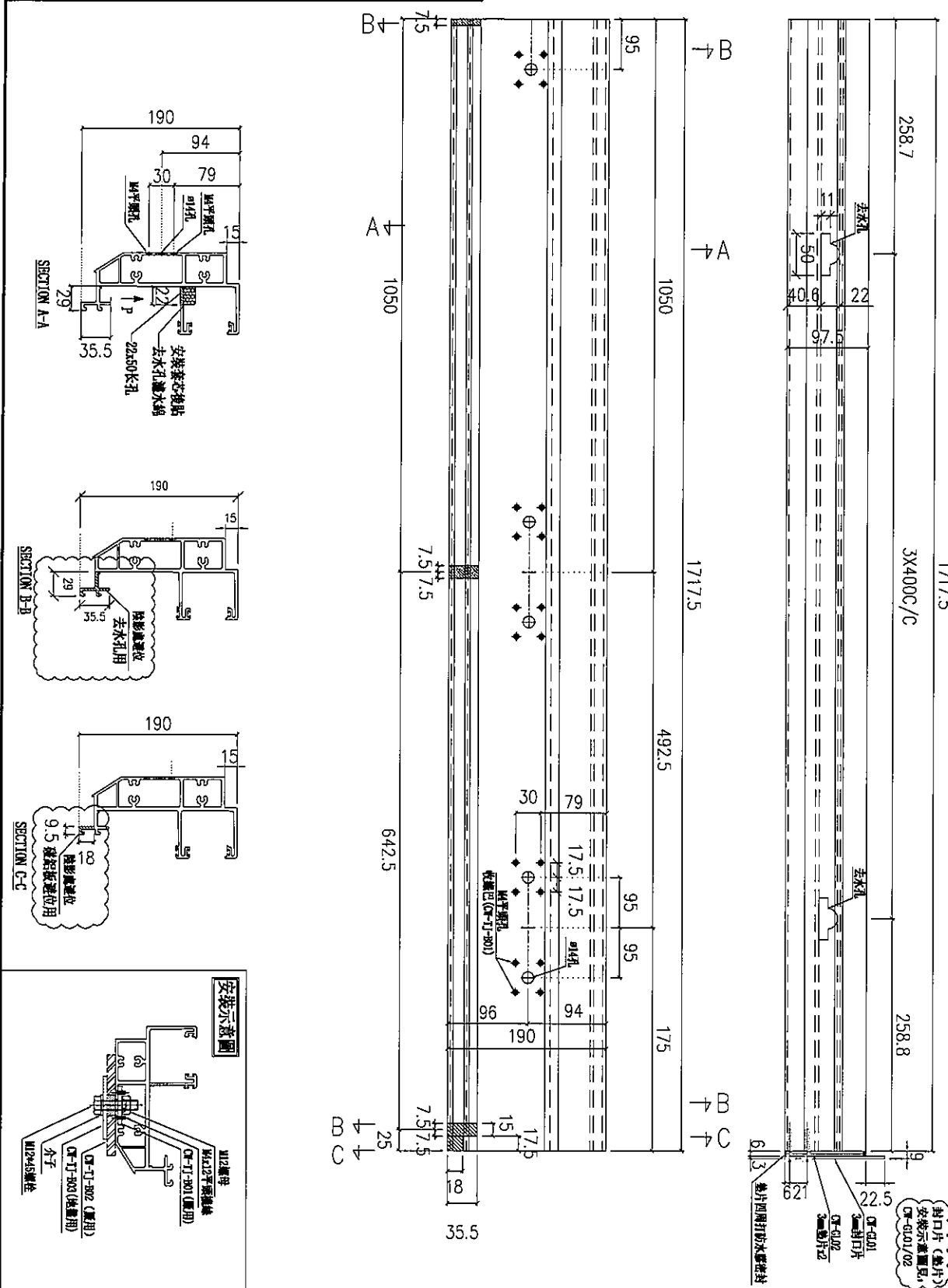

名稱	頂橫	制圖	陳敏聰	2022.03.11	修改
材料	X85982	復核	謝永林	2022.03.21	日期
顏色	JMQ213457(3 coatings)	批准			圖號 J853-T6-CW-S04b

請用A3紙打印

使用位置: J853-SD-CW-4602A

數量: 1

封口片 (裝片)
安裝示意圖見
DW-6101/02

美特鋁質有限公司
MIDI Aluminium Fabricator Ltd.

工程號: J853 地盤: 延坪道

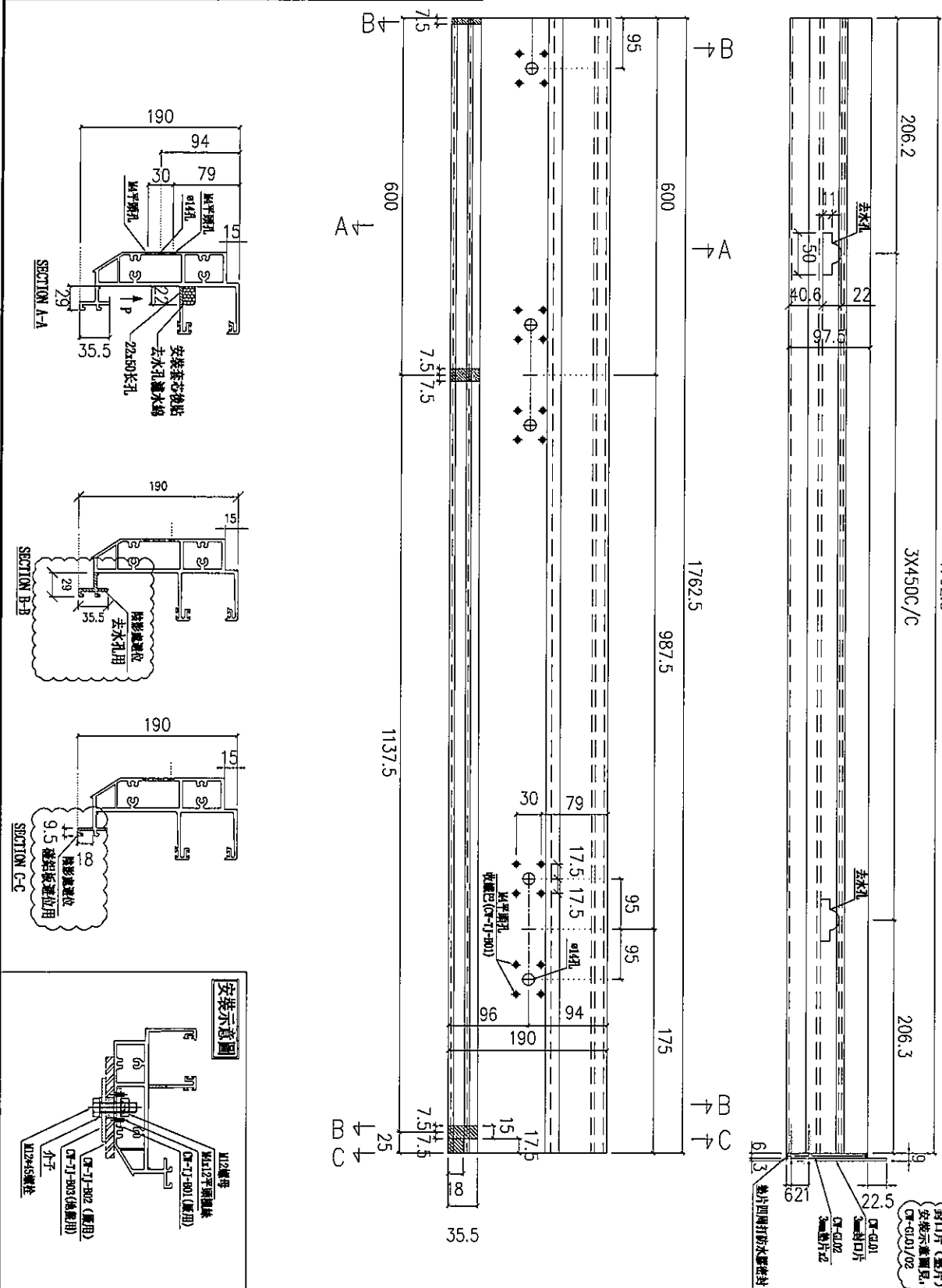

名稱	頂橫	制圖	陳敏聰	2022.03.11	修改
材料	X85982	復核	謝永林	2022.03.21	日期
顏色	JMQ213457(3 coatings)	批准			圖號
					J853-T6-CW-S05b

請用A3紙打印

使用位置 J853-SD-CW-4606

數量: 1

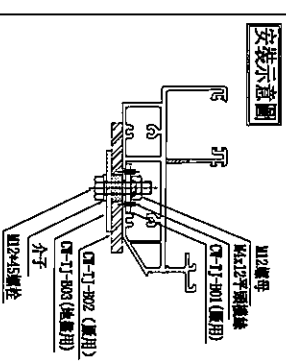
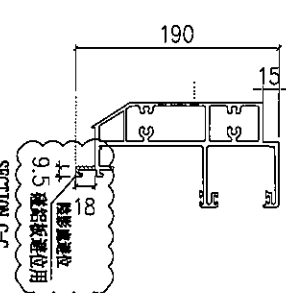
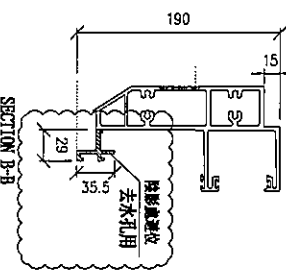
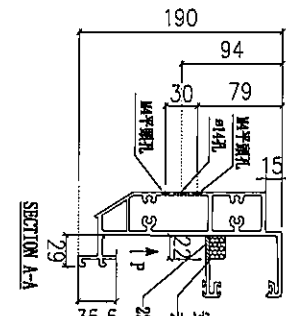
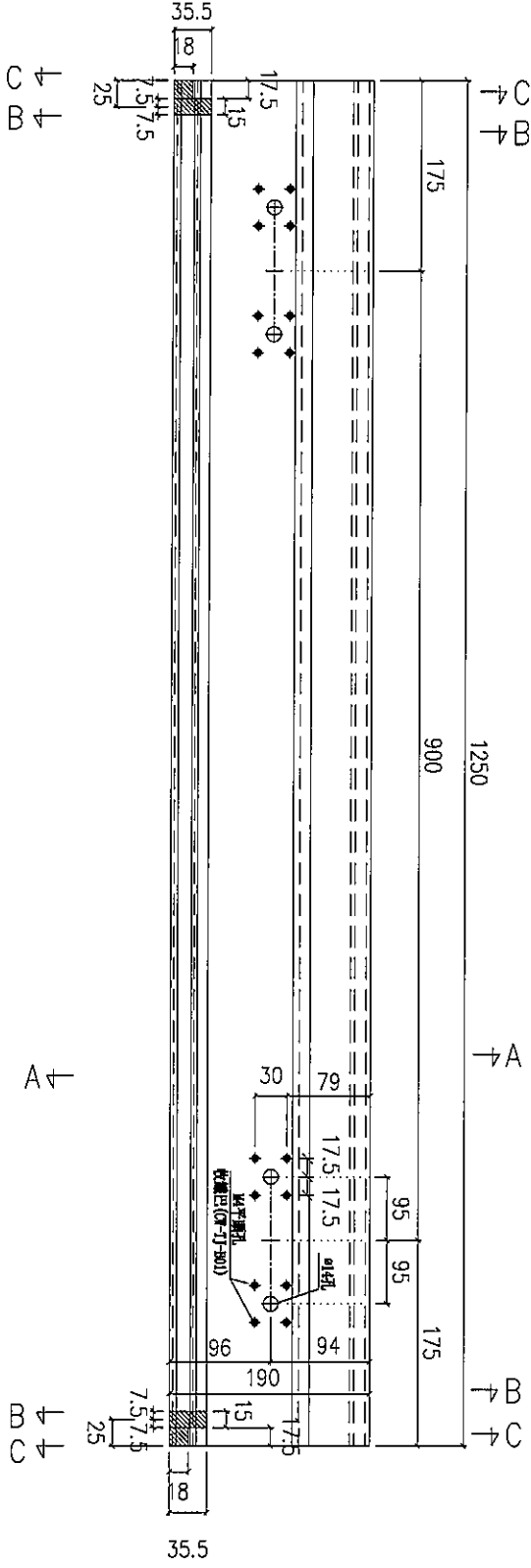
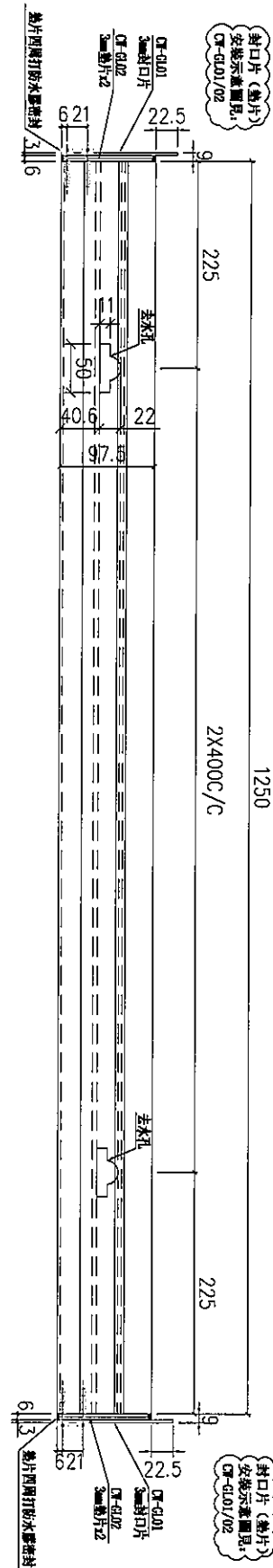

名稱	頂橫	制圖	陳敏聰	2022.03.11	修改	
材料	X85982	復核	謝永林	2022.03.21	日期	
顏色	JMQ213457(3 coatings)	批准			圖號	J853-T6-CW-S06

請用A3紙打印

使用位置 J853-SD-CW-4606

數量: 1

封口片 (總片)
安裝位置圖見:
CW-C101/02

美特鋁質有限公司
MIDI Aluminium Fabricator Ltd.

工程號 J853 地盤 延坪道

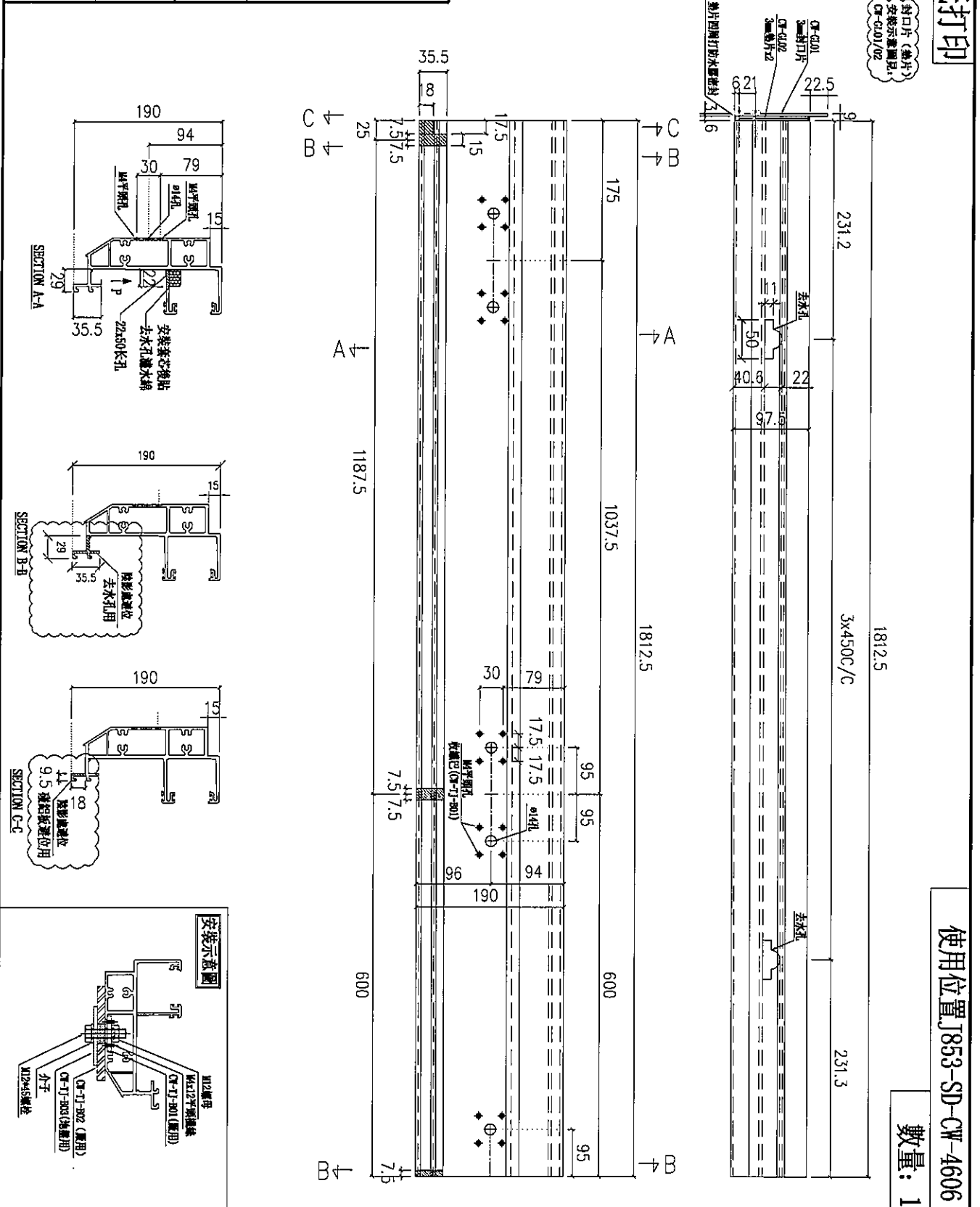

名稱	頂橫	制圖	陳敏聰	2022.03.11	修改	
材料	X85982	復核	謝永林	2022.03.21	日期	
顏色	JMQ213457(3 coatings)	批准			圖號	J853-T6-CW-S07a

請用A3紙打印

使用位置 J853-SD-CW-4606

數量: 1

封口袋 (封片)
安裝示意圖見
CW-010/02

美特鋁質有限公司
MIDI Aluminium Fabricator Ltd.

工程號	J853	地盤	延坪道
-----	------	----	-----

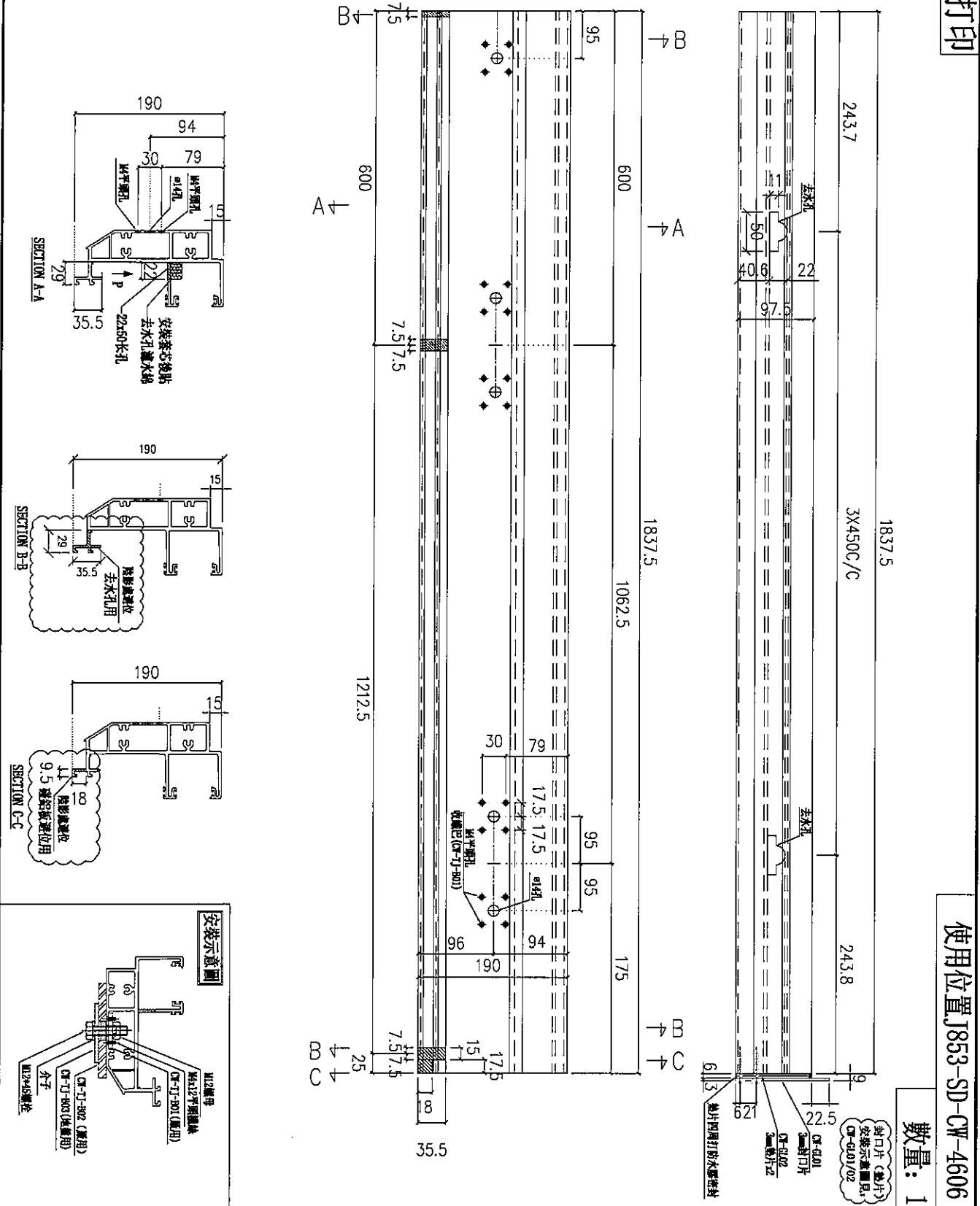

名稱	頂橫	制圖	陳敏聰	2022.03.11	修改
材料	X85982	復核	謝永林	2022.03.21	日期
顏色	JMQ213457(3 coatings)	批准			圖號
					J853-T6-CW-S07b

美特鋁質有限公司
MIDI Aluminium Fabricator Ltd.

工程號 J853 地盤 延坪道

請用A3紙打印

使用位置J853-SD-CW-4607

數量: 1

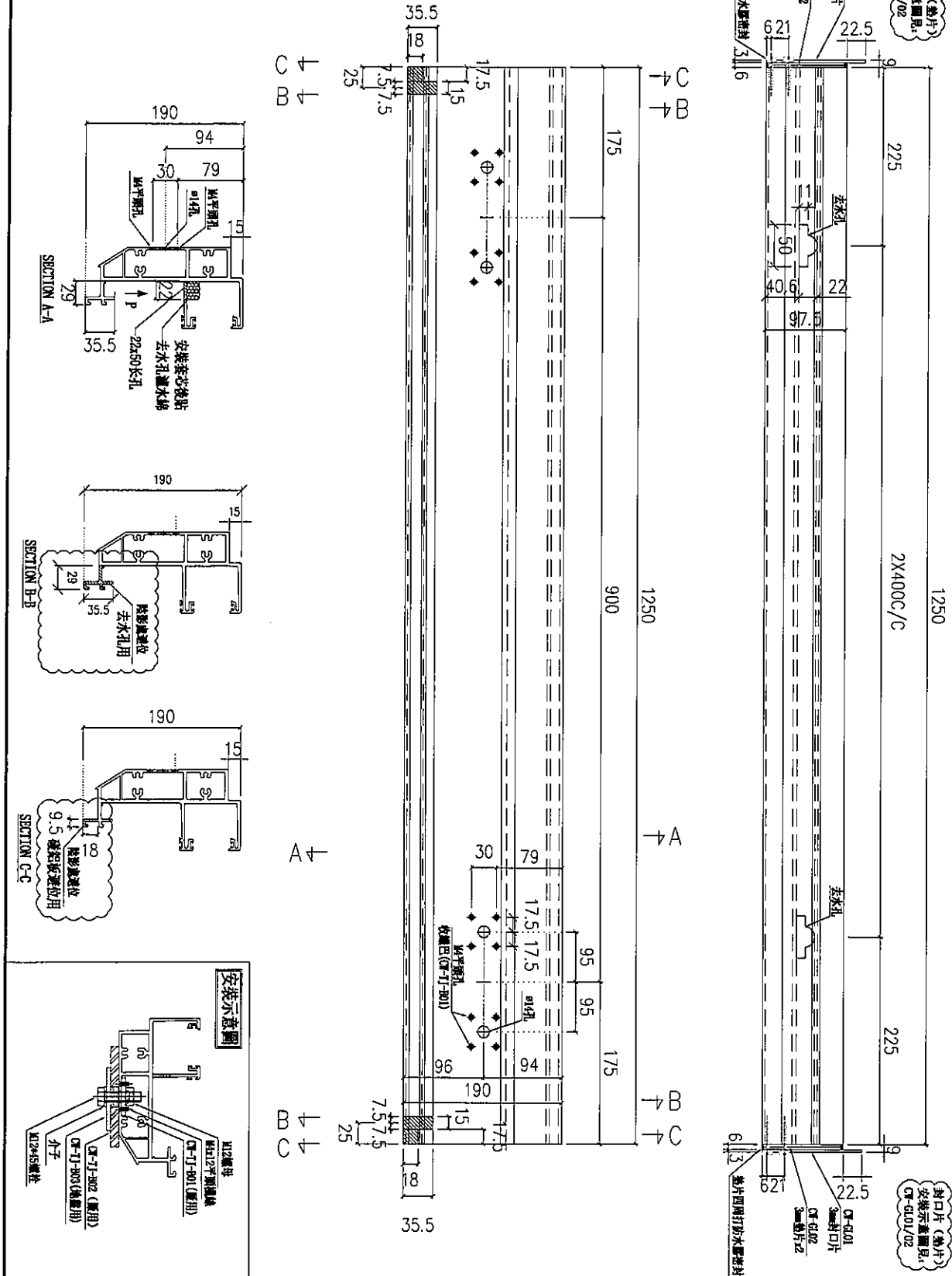

名稱	頂橫	制圖	陳敏聰	2022.03.11	修改	
材料	X85982	復核	謝永林	2022.03.21	日期	
顏色	JMQ213457(3 coatings)	批准			圖號	J853-T6-CW-S08

請用A3紙打印

使用位置 J853-SD-CW-4607

數量: 1

美特鋁質有限公司
MIDI Aluminium Fabricator Ltd.

工程號 J853 地盤 延坪道

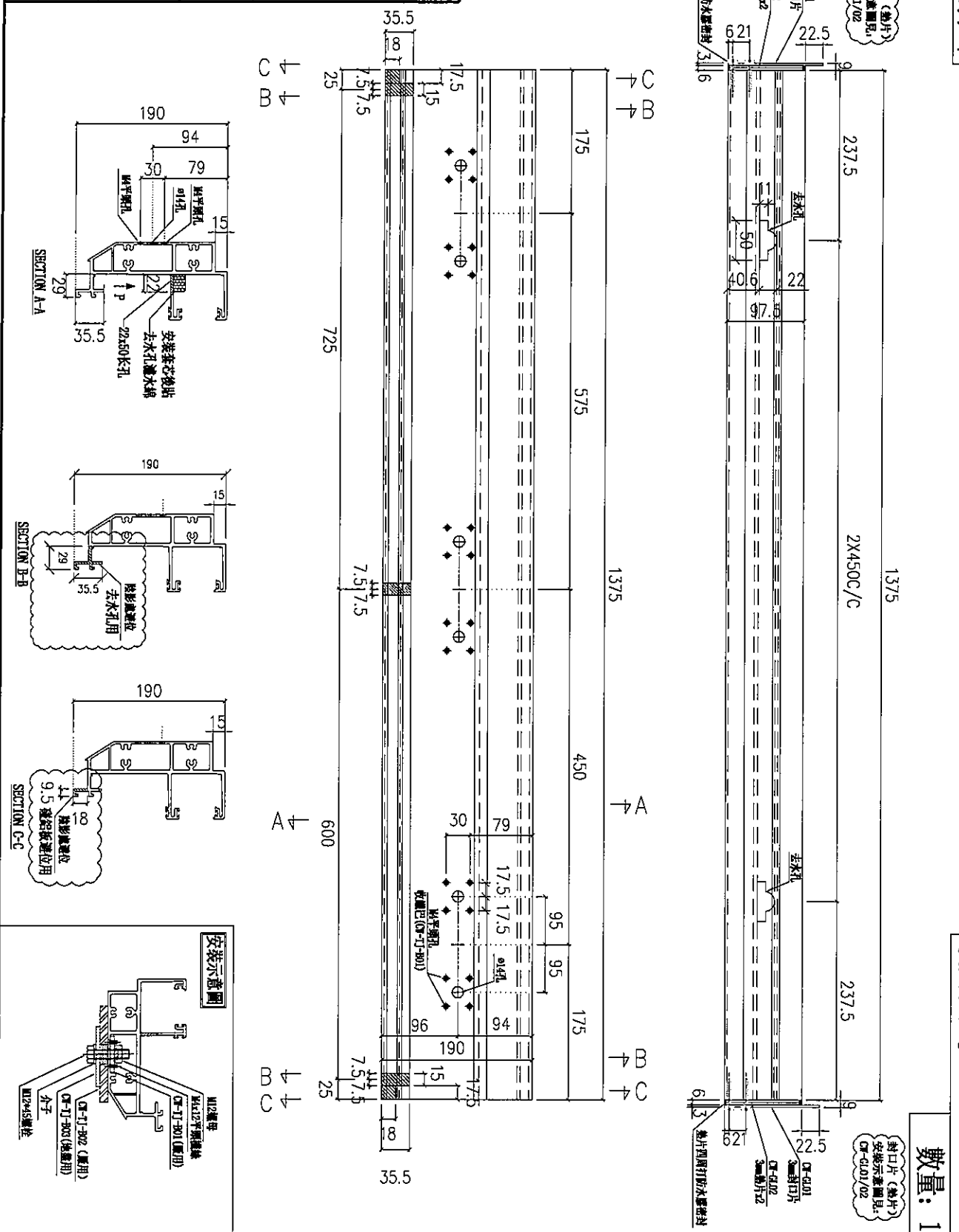

名稱	頂橫	制圖	陳敏聰	2022.03.11	修改
材料	X85982	復核	謝永林	2022.03.21	日期
顏色	JMQ213457(3 coatings)	批准			圖號 J853-T6-CW-S09

EG-DWG3

美特鋁質有限公司
 MIDI Aluminium Fabricator Ltd.

工程號	J853	地盤	延坪道
-----	------	----	-----

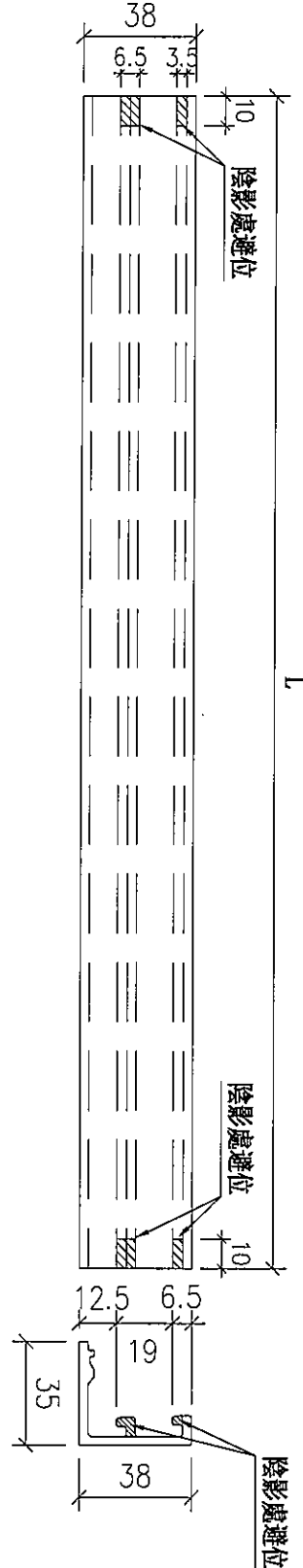

詳細數據請參考圖號
J853-T6-CW-KG01BM

名稱	玻璃扣蓋	制圖	陳敏聰	2022.03.16	修改		
材料	X85989	復核	謝永林	2022.03.21	日期		
顏色	JMQ213457(3 coatings)	批准			圖號	J853-T6-CW-KG01	

數量: 1

封口片 (墊片)
安裝示意圖見
CW-G01/02

美特鋁質有限公司
MIDI Aluminium Fabricator Ltd.

工程號	J853	地盤	延坪道
-----	------	----	-----

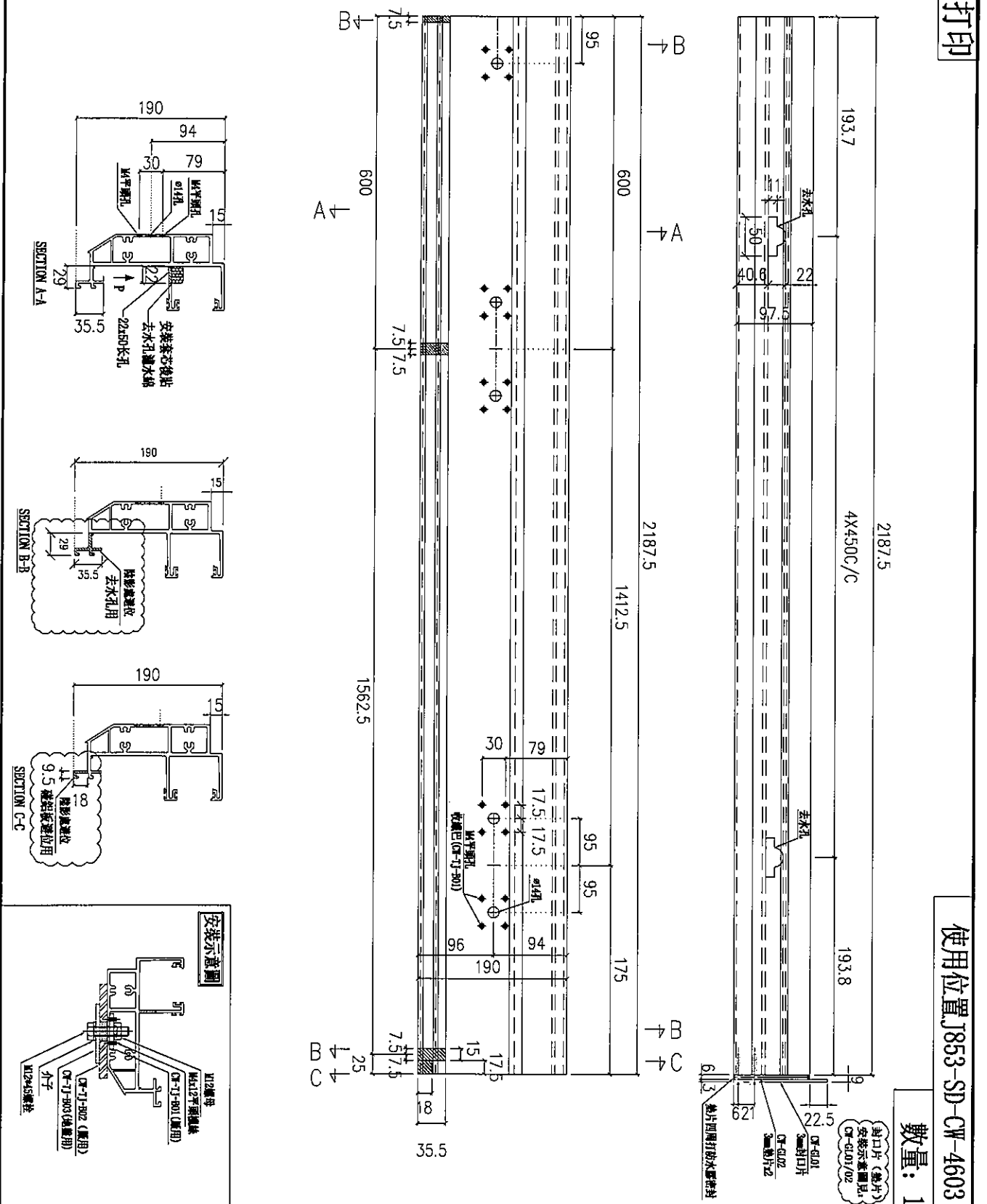

名稱	頂橫	制圖	陳敏聰	2022.03.11	修改
材料	X85982	復核	謝永林	2022.03.21	日期
顏色	JMQ213457(3 coatings)	批准			圖號
					J853-T7-CW-S02b

請用A3紙打印

封口片 (鋁片)
安裝示意圖見:
CW-T101/02

使用位置 J853-SD-CW-4604

數量: 1

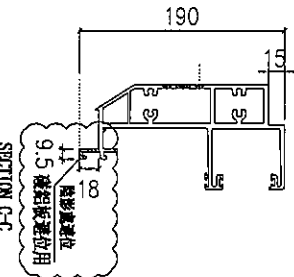
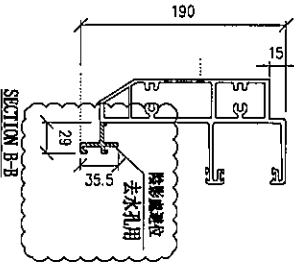
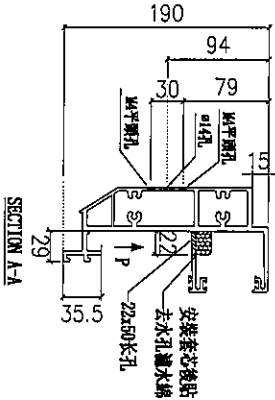
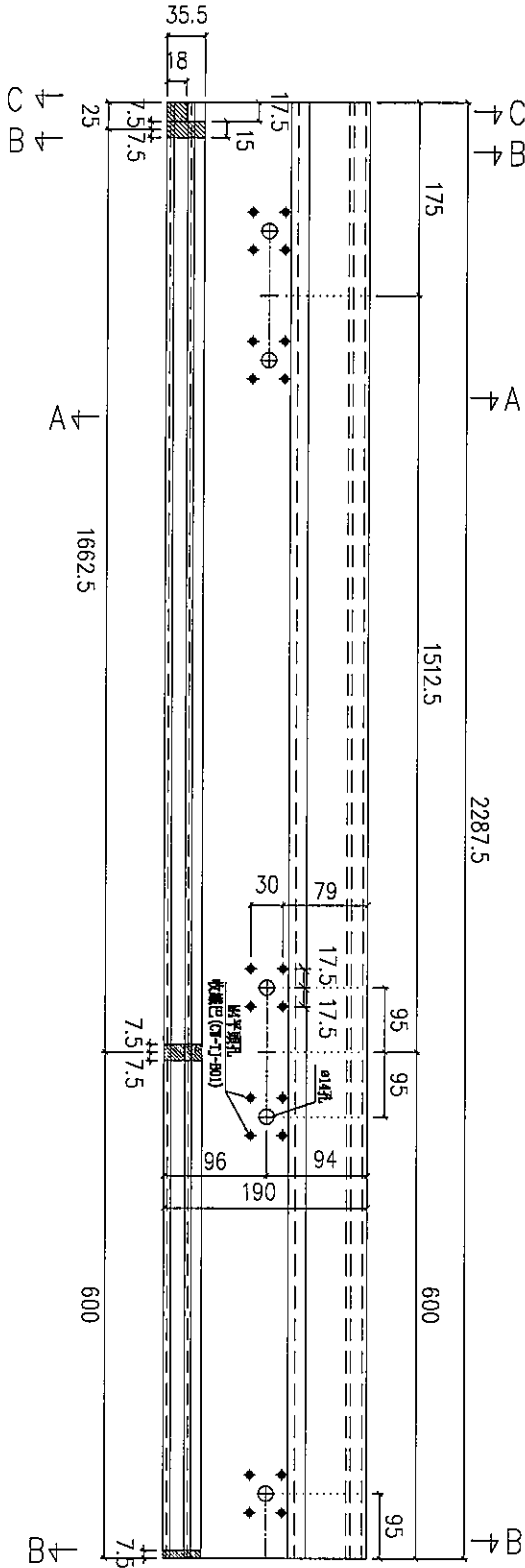
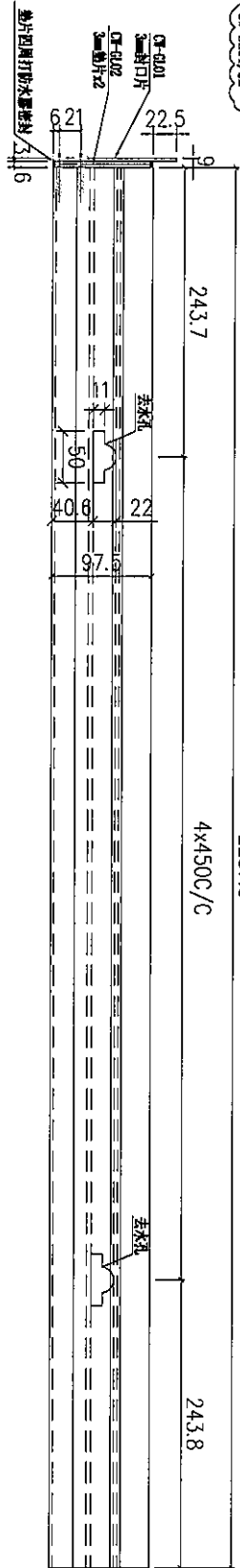

安裝示意圖

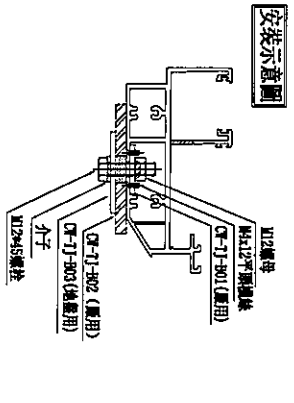

名稱	頂橫	制圖	陳敏聰	2022.03.11	修改
材料	X85982	復核	謝永林	2022.03.21	日期
顏色	JMQ213457(3 coatings)	批准			圖號 J853-T7-CW-S04a

數量: 1

封口片 (墊片)
安裝示意圖見:
CW-601/02

美特鋁質有限公司
MIDI Aluminium Fabricator Ltd.

工程號	J853	地盤	延坪道
-----	------	----	-----

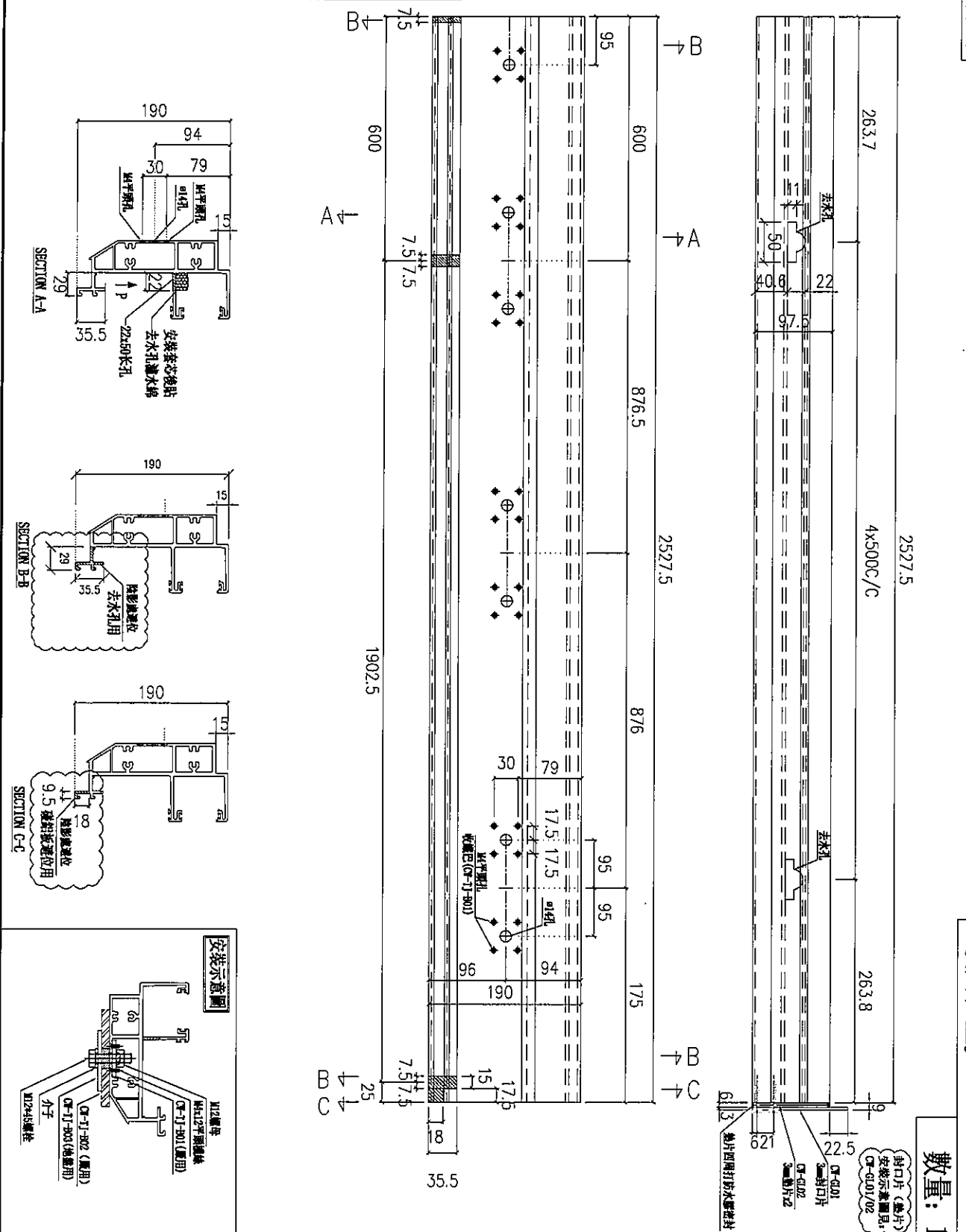

名稱	頂橫	制圖	陳敏聰	2022.03.11	修改
材料	X85982	復核	謝永林	2022.03.21	日期
顏色	JMQ213457(3 coatings)	批准			圖號 J853-T7-CW-S04b

請用A3紙打印

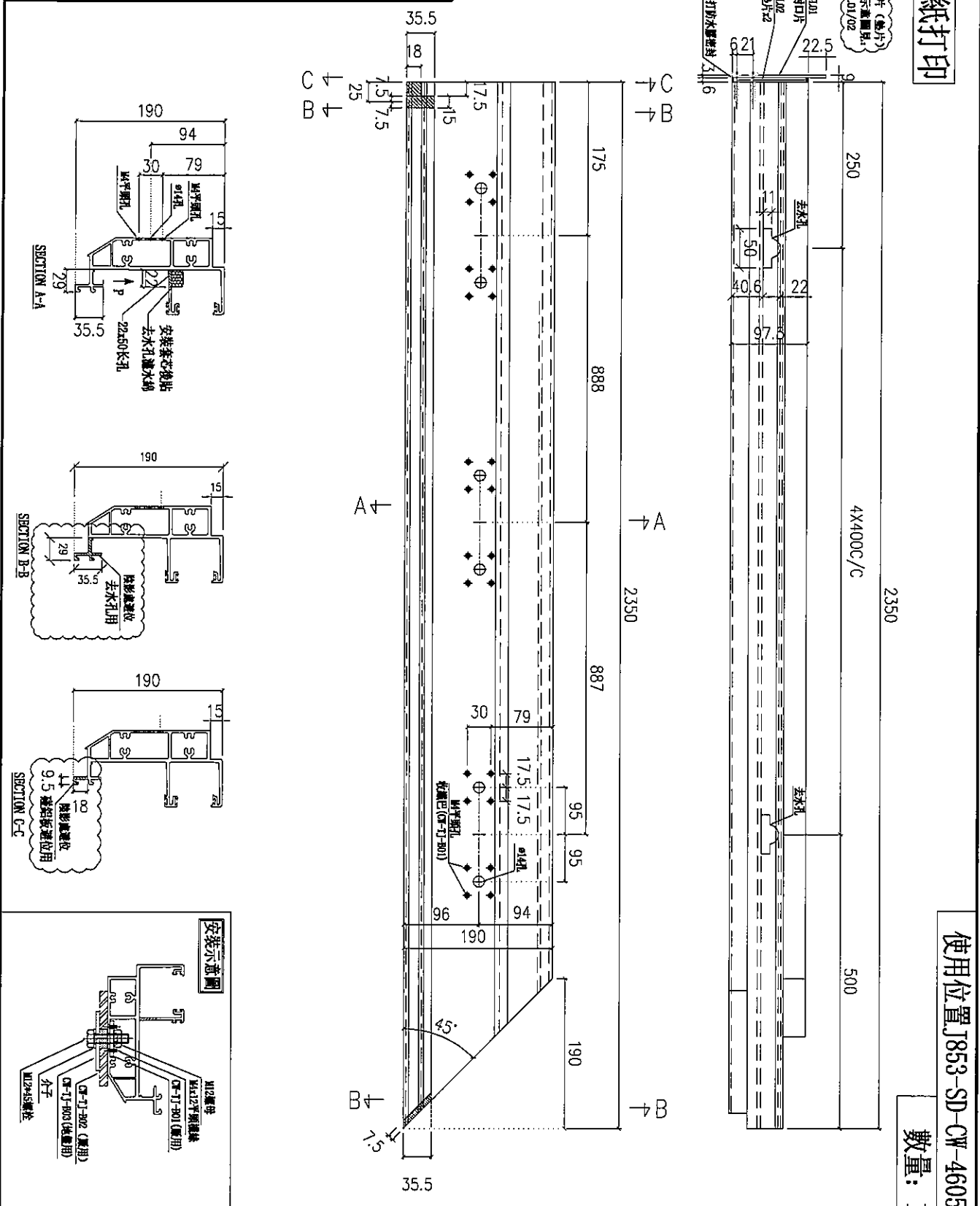

使用位置 J853-SD-CW-4605

數量: 1

名稱	頂橫	制圖	陳敬聰	2022.03.16	修改	
材料	X85982	復核	謝永林	2022.03.19	日期	
顏色	JMQ213457(3 coatings)	批准			圖號	J853-T7-CW-S05

請用A3紙打印

使用位置 J853-SD-CW-4605

數量: 1

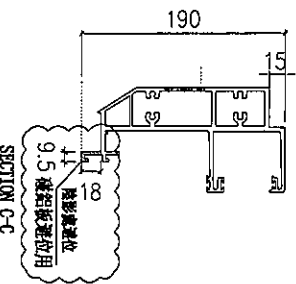
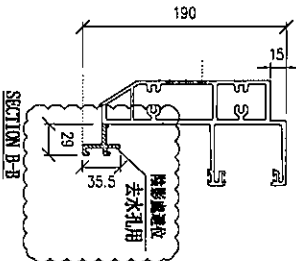
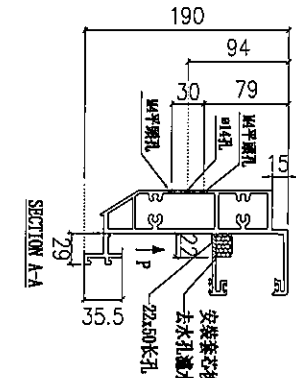
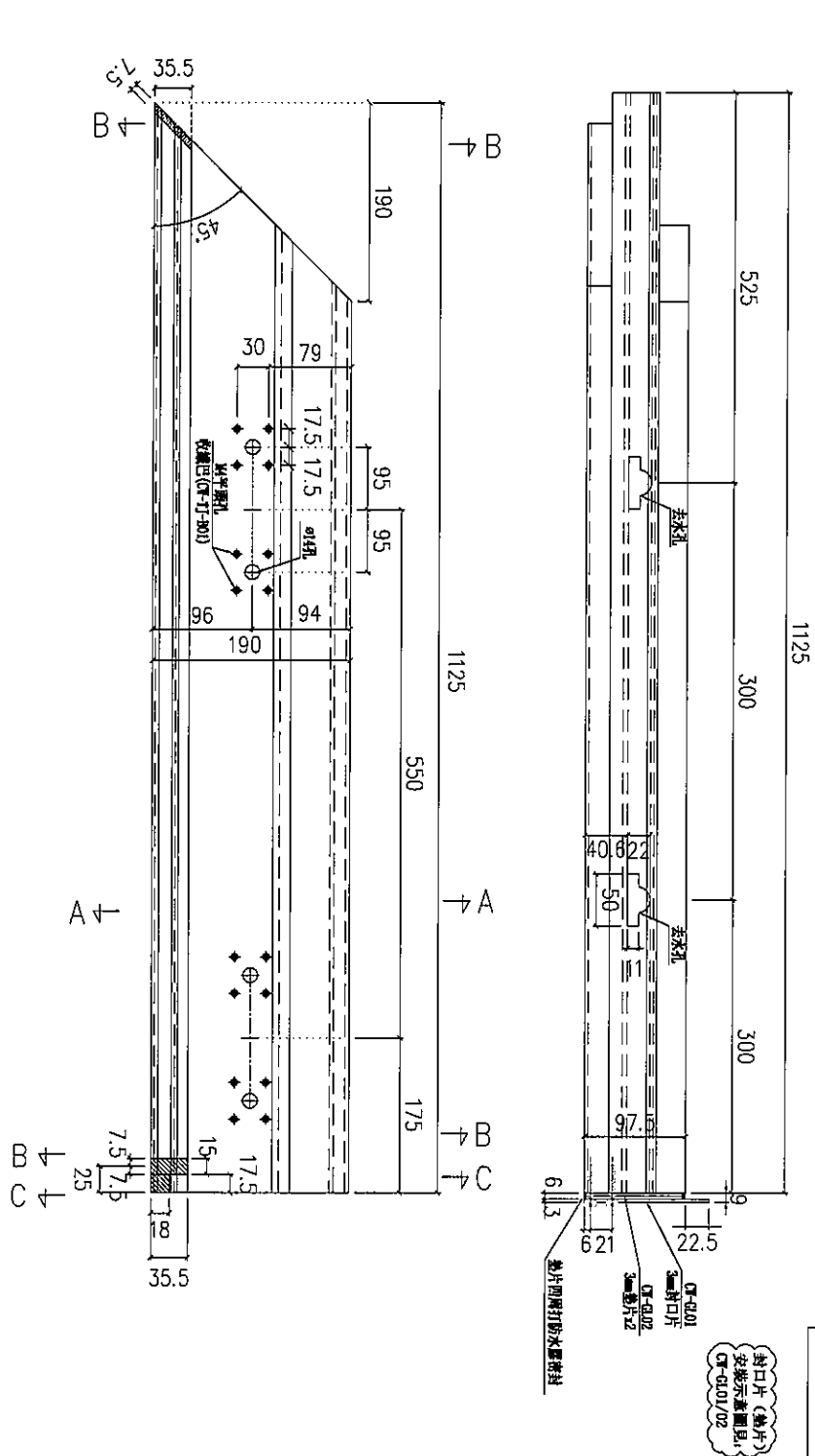

安裝示意圖

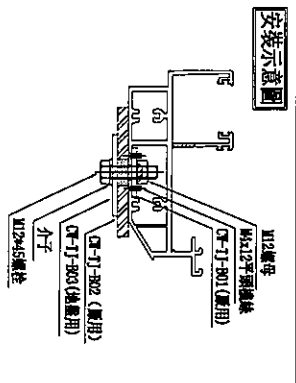

名稱	頂橫	制圖	陳敏聰	2022.03.16	修改
材料	X85982	復核	謝永林	2022.03.19	日期
顏色	JMQ213457(3 coatings)	批准			圖號 J853-T7-CW-S06

EG-DWG3

美特鋁質有限公司
 MIDI Aluminium Fabricator Ltd.

工程號	J853	地盤	延坪道
-----	------	----	-----

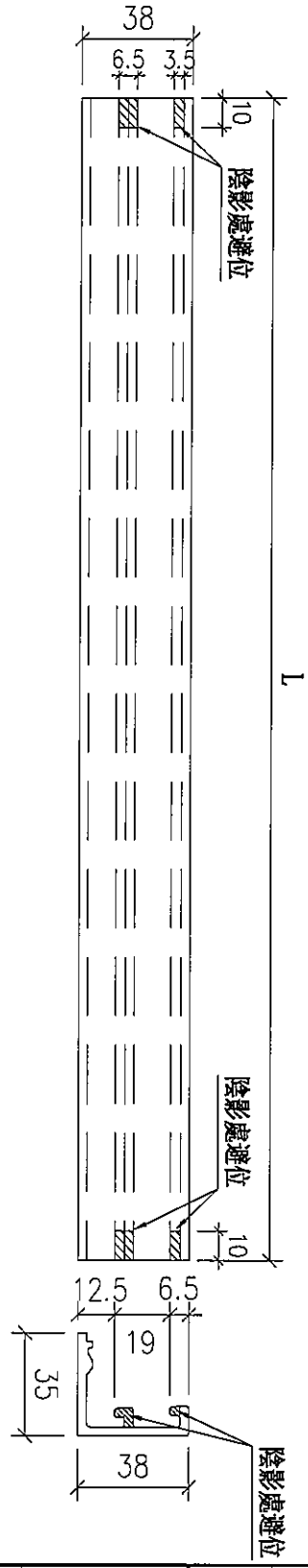

詳細數據請參考圖號
J853-T7-CW-KG01BM

名稱	玻璃扣蓋	制圖	陳敏聰	2022.03.16	修改		
材料	X85989	復核	謝永林	2022.03.21	日期		
顏色	JMQ213457(3 coatings)	批准			圖號	J853-T7-CW-KG01	

EG-DWG3

 美特鋁質有限公司
MIDI Aluminium Fabricator Ltd.

工程號 J853 地盤 延坪道

圖號	扣蓋長度 (L)	分格寬度	數量	使用位置
J853-T7-CW-KG01a	1087.5	1102.5	1	J853-SD-CW-4603
J853-T7-CW-KG01b	1035	1050	1	J853-SD-CW-4603
J853-T7-CW-KG01c	627.5	642.5	1	J853-SD-CW-4603
J853-T7-CW-KG02a	585	600	1	J853-SD-CW-4603
J853-T7-CW-KG02b	1272.5	1287.5	1	J853-SD-CW-4603
J853-T7-CW-KG02c	585	600	1	J853-SD-CW-4603
J853-T7-CW-KG02d	1547.5	1562.5	1	J853-SD-CW-4603
J853-T7-CW-KG03	770	785	1	J853-SD-CW-4604
J853-T7-CW-KG04a	1647.5	1662.5	1	J853-SD-CW-4604
J853-T7-CW-KG04b	585	600	1	J853-SD-CW-4604
J853-T7-CW-KG04c	585	600	1	J853-SD-CW-4604
J853-T7-CW-KG04d	1887.5	1902.5	1	J853-SD-CW-4604
J853-T7-CW-KG07a	800	815	1	J853-SD-CW-4608
J853-T7-CW-KG07b	1360	1375	1	J853-SD-CW-4608

名稱	玻璃扣蓋數據表	制圖	陳敏聰	2022.03.16	修改		
材料	X85989	復核	謝永林	2022.03.21	日期		
顏色	JMQ213457(3 coatings)	批准			圖號	J853-T7-CW-KG01BM	

EG-DWG3

美特鋁質有限公司
MIDI Aluminium Fabricator Ltd.

工程號 J853 地盤 延坪道

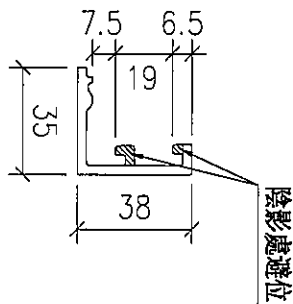
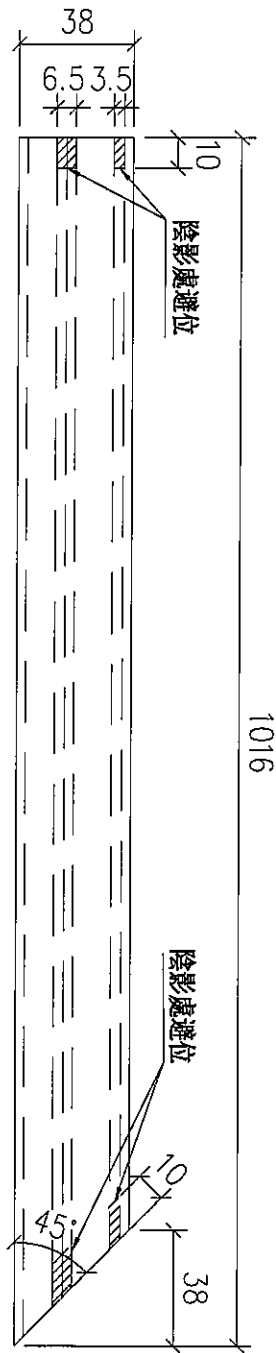

圖號	J853-T7-CW-KG05	扣蓋長度 (L)	2016	分格寬度	2025	數量	1	使用位置	J853-SD-CW-4605
----	-----------------	----------	------	------	------	----	---	------	-----------------

名稱	玻璃扣蓋	制圖	陳敏聰	2022.03.16	修改				
材料	X85989	復核	謝永林	2022.03.21	日期				
顏色	JMQ213457(3 coatings)	批准			圖號	J853-T7-CW-KG05			

美特鋁質有限公司
MIDI Aluminium Fabricator Ltd.

工程號 J853 地盤 延坪道

圖號	扣蓋長度 (L)	分格寬度	數量	使用位置
J853-T7-CW-KG06	1091	1100	1	J853-SD-CW-4605

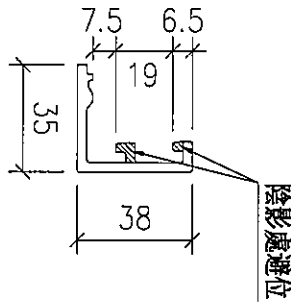
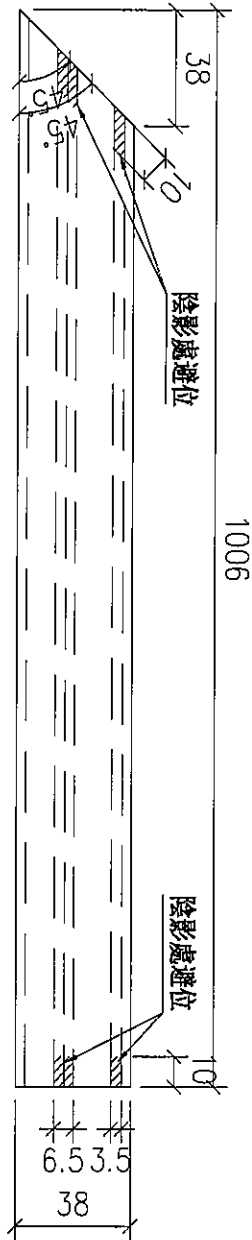

名稱	玻璃扣蓋	制圖	陳敏聰	2022.03.16	修改		
材料	X85989	復核	謝永林	2022.03.21	日期		
顏色	JMQ213457(3 coatings)	批准			圖號	J853-T7-CW-KG06	

D.D. REF :

CLIENT : SHIMAO GROUP HOLDINGS LIMITED

ARCHITECT : HONG TING & PARTNERS LIMITED



MAIN CONTRACTOR : 德興建築有限公司 HING HING CONSTRUCTION CO. LTD

STRUCTURAL ENGINEER :

CMA CH WONG & ASSOCIATES LTD 黃志明建築工程師有限公司

PAOGE CONSULTANT :



NOTE: 1. ALL DIMENSIONS ARE IN MM. 2. ALL DIMENSIONS ARE VIEWED FROM OUTSIDE. 3. ALL DIMENSIONS TO BE VERIFIED ON SITE BEFORE FABRICATION.

LEGEND:

- 1. TOTAL WORK NO. 2. REFER SHEET NO. 1. F.F.L. --- FINISHED FLOOR LEVEL 2. S.F.L. --- STRUCTURAL FLOOR LEVEL 3. --- REVERSED DETAIL

Table with columns: No., Description, Date, Status, Rev.

JOB NO.: J-853 PROJECT: PROPOSED RESIDENTIAL DEVELOPMENT AT N.K.L.L. 6942 YIN PING ROAD KOWLOON

TITLE: PART ELEVATION FOR CURTAIN WALL AT TOWER 6 & 7

DATE: 12-APR-21 SCALE: 1:60 (A1) DRAWN BY: LHR CHECKED BY: 美特銘有限公司 MIDTI Architectural Manufacture Ltd. Units 6-8, Sunny Industrial Centre, 1/F 142, ARBURI LANE, TAI KOWI, HONG KONG TEL: (852) 27272666

FLOOR LEVEL (S.F.L.) table with columns: FLOOR LEVEL, 21000, 20870, 20740, 20610, 20480, 20350, 20220, 20090, 19960, 19830, 19700, 19570, 19440, 19310, 19180, 19050, 18920, 18790, 18660, 18530, 18400, 18270, 18140, 18010, 17880, 17750, 17620, 17490, 17360, 17230, 17100, 16970, 16840, 16710, 16580, 16450, 16320, 16190, 16060, 15930, 15800, 15670, 15540, 15410, 15280, 15150, 15020, 14890, 14760, 14630, 14500, 14370, 14240, 14110, 13980, 13850, 13720, 13590, 13460, 13330, 13200, 13070, 12940, 12810, 12680, 12550, 12420, 12290, 12160, 12030, 11900, 11770, 11640, 11510, 11380, 11250, 11120, 10990, 10860, 10730, 10600, 10470, 10340, 10210, 10080, 9950, 9820, 9690, 9560, 9430, 9300, 9170, 9040, 8910, 8780, 8650, 8520, 8390, 8260, 8130, 8000, 7870, 7740, 7610, 7480, 7350, 7220, 7090, 6960, 6830, 6700, 6570, 6440, 6310, 6180, 6050, 5920, 5790, 5660, 5530, 5400, 5270, 5140, 5010, 4880, 4750, 4620, 4490, 4360, 4230, 4100, 3970, 3840, 3710, 3580, 3450, 3320, 3190, 3060, 2930, 2800, 2670, 2540, 2410, 2280, 2150, 2020, 1890, 1760, 1630, 1500, 1370, 1240, 1110, 980, 850, 720, 590, 460, 330, 200, 70, -60, -130, -200, -270, -340, -410, -480, -550, -620, -690, -760, -830, -900, -970, -1040, -1110, -1180, -1250, -1320, -1390, -1460, -1530, -1600, -1670, -1740, -1810, -1880, -1950, -2020, -2090, -2160, -2230, -2300, -2370, -2440, -2510, -2580, -2650, -2720, -2790, -2860, -2930, -3000, -3070, -3140, -3210, -3280, -3350, -3420, -3490, -3560, -3630, -3700, -3770, -3840, -3910, -3980, -4050, -4120, -4190, -4260, -4330, -4400, -4470, -4540, -4610, -4680, -4750, -4820, -4890, -4960, -5030, -5100, -5170, -5240, -5310, -5380, -5450, -5520, -5590, -5660, -5730, -5800, -5870, -5940, -6010, -6080, -6150, -6220, -6290, -6360, -6430, -6500, -6570, -6640, -6710, -6780, -6850, -6920, -6990, -7060, -7130, -7200, -7270, -7340, -7410, -7480, -7550, -7620, -7690, -7760, -7830, -7900, -7970, -8040, -8110, -8180, -8250, -8320, -8390, -8460, -8530, -8600, -8670, -8740, -8810, -8880, -8950, -9020, -9090, -9160, -9230, -9300, -9370, -9440, -9510, -9580, -9650, -9720, -9790, -9860, -9930, -10000

- LEGEND: 10mm HEAT STRENGTHENED GLASS (QUITE) + 12mm AIR SPACE + 12mm THK. TEMPERED CLEAR GLASS (INNER) + 12mm AIR SPACE + 12mm THK. TEMPERED CLEAR GLASS (INNER) + 12mm THK. HEAT STRENGTHENED GLASS & 2mm THK. ALUM. (ADOPHAN (SPANDREL GLASS) (INTERNAL PROTECTIVE BARRIER)) - 3mm THK. ALUM. GLAZING S.S. - STACK JOINT (WIND LOAD) A.L.U.M. EXTENSION DE HO. SUPPORT POINT (WIND LOAD + DEAD LOAD) SUPPORT POINT (WIND LOAD)

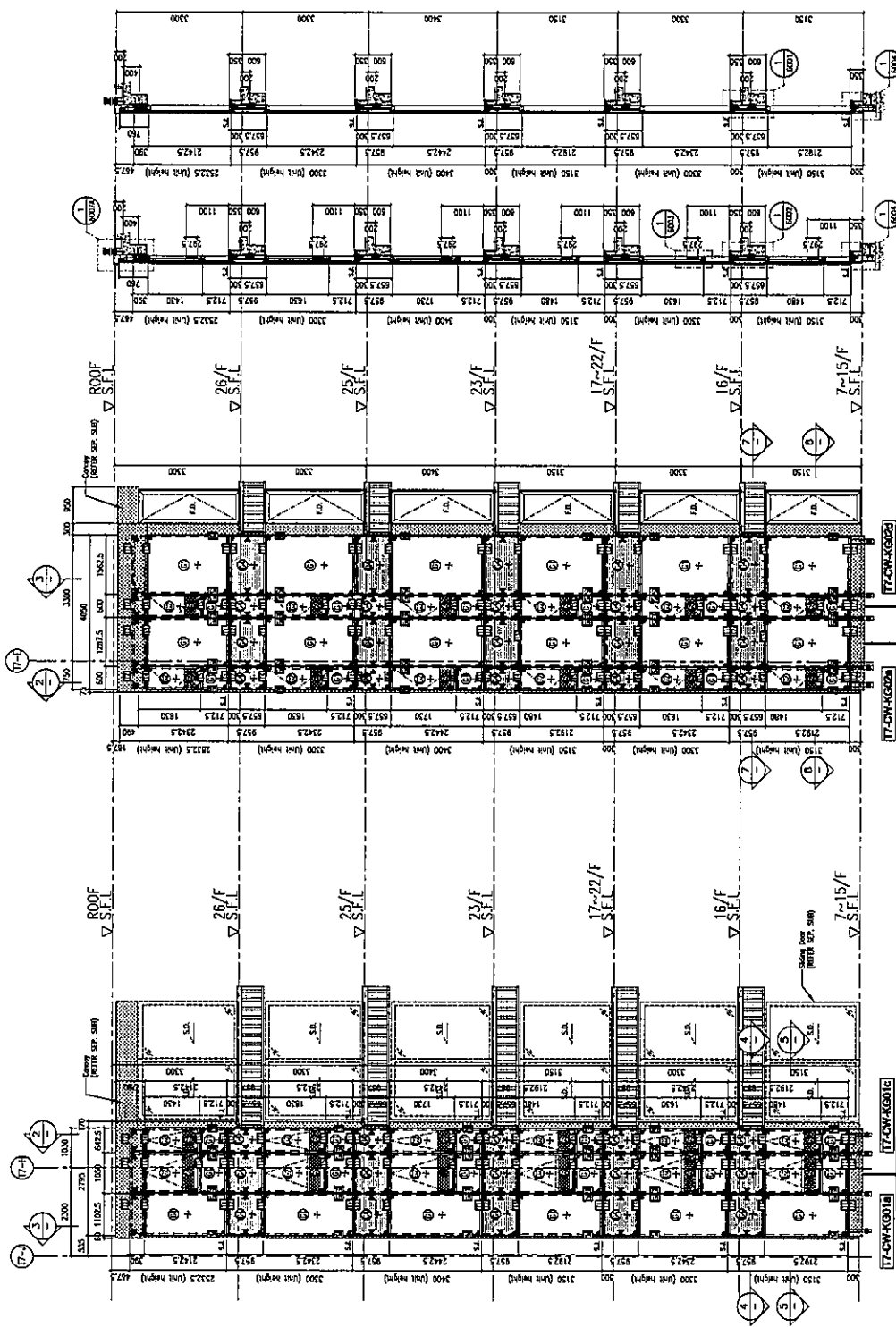

2 TYPICAL SECTION FOR CURTAIN WALL

3 TYPICAL SECTION FOR CURTAIN WALL

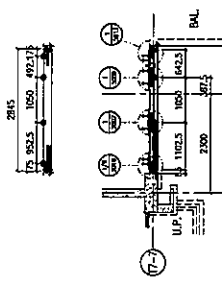
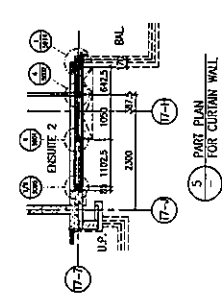
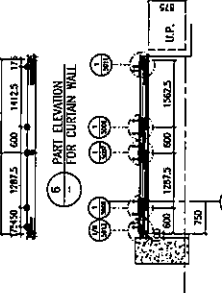
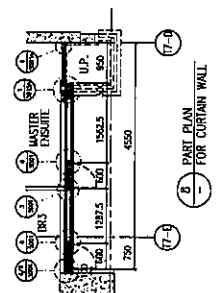

4 PART PLAN FOR CURTAIN WALL

5 PART PLAN FOR CURTAIN WALL

6 PART PLAN FOR CURTAIN WALL

7 PART PLAN FOR CURTAIN WALL

B.B. REF :

請用A3紙打印

CLIENT : SHIMAO GROUP HOLDINGS LIMITED

ARCHITECT : HONG TUNG & PARTNERS LIMITED

MAIN CONTRACTOR : 美特銘有限公司 SHIMAO CONSTRUCTION CO. LTD

STRUCTURAL ENGINEER : C.H. WONG & ASSOCIATES LTD 黃志輝建築工程師有限公司

FAÇADE CONSULTANT : MEINHARDT

NOTE:
 1. ALL DIMENSIONS ARE IN METR.
 2. ALL ELEVATIONS ARE VIEWED FROM OUTSIDE.
 3. ALL DIMENSIONS TO BE VERIFIED ON SITE BEFORE FABRICATION.

LEGEND:
 1. DETAIL MARK NO.
 2. REFER SHEET NO.
 1. F.F.L. --- FINISHED FLOOR LEVEL.
 2. S.F.L. --- STRUCTURAL FLOOR LEVEL.
 3. --- REVERSED DETAIL.

PROJECT : PROPOSED RESIDENTIAL DEVELOPMENT AT 1/K.L.L. 6542 YUN PING ROAD KOWLOON

TITLE : PART ELEVATION FOR CURTAIN WALL AT TOWER 6 & 7

DATE : 12-APR-21 SCALE : 1:80 (A1)

DRAWN BY : LHR CHECKED BY :

美特銘有限公司
 MTI MIDLAND INTERNATIONAL ASSOCIATE LTD.
 Units 6-8, Sunny Industrial Centre, 1/F
 311 Chee Hong Road, Tsimshatsui
 HONG KONG TEL: (852) 27272665
 DWG NO.: H533-SD-CW-4804 REV.: A

FLOOR LEVEL (S.F.L.)	FLOOR LEVEL
25/F	+203.525
24/F	+200.025
23/F	+196.525
22/F	+193.025
21/F	+189.525
20/F	+186.025
19/F	+182.525
18/F	+179.025
17/F	+175.525
16/F	+172.025
15/F	+168.525
14/F	+165.025
13/F	+161.525
12/F	+158.025
11/F	+154.525
10/F	+151.025
9/F	+147.525
8/F	+144.025
7/F	+140.525

LEGEND:
 1. 100mm HEAT STRENGTHENED GLASS (OUTER) + 12mm AIR SPACE + 12mm THK. TEMPERED CLEAR GLASS (INNER)
 2. 100mm HEAT STRENGTHENED GLASS (OUTER) + 12mm AIR SPACE + 12mm THK. TEMPERED CLEAR GLASS (INNER)
 3. 12mm THK. HEAT STRENGTHENED GLASS & 2mm THK. ALUM. BACKWALL (SPANDREL GLASS) (INTERNAL PROTECTIVE BARRIER)
 4. 3mm THK. ALUM. CLADDING
 S.L. --- STACK JOINT (WIND LOAD)
 ALUM. --- ALUM. EXTRUSION (WIND LOAD)
 SUPP. --- SUPPORT POINT (WIND LOAD + DEAD LOAD)

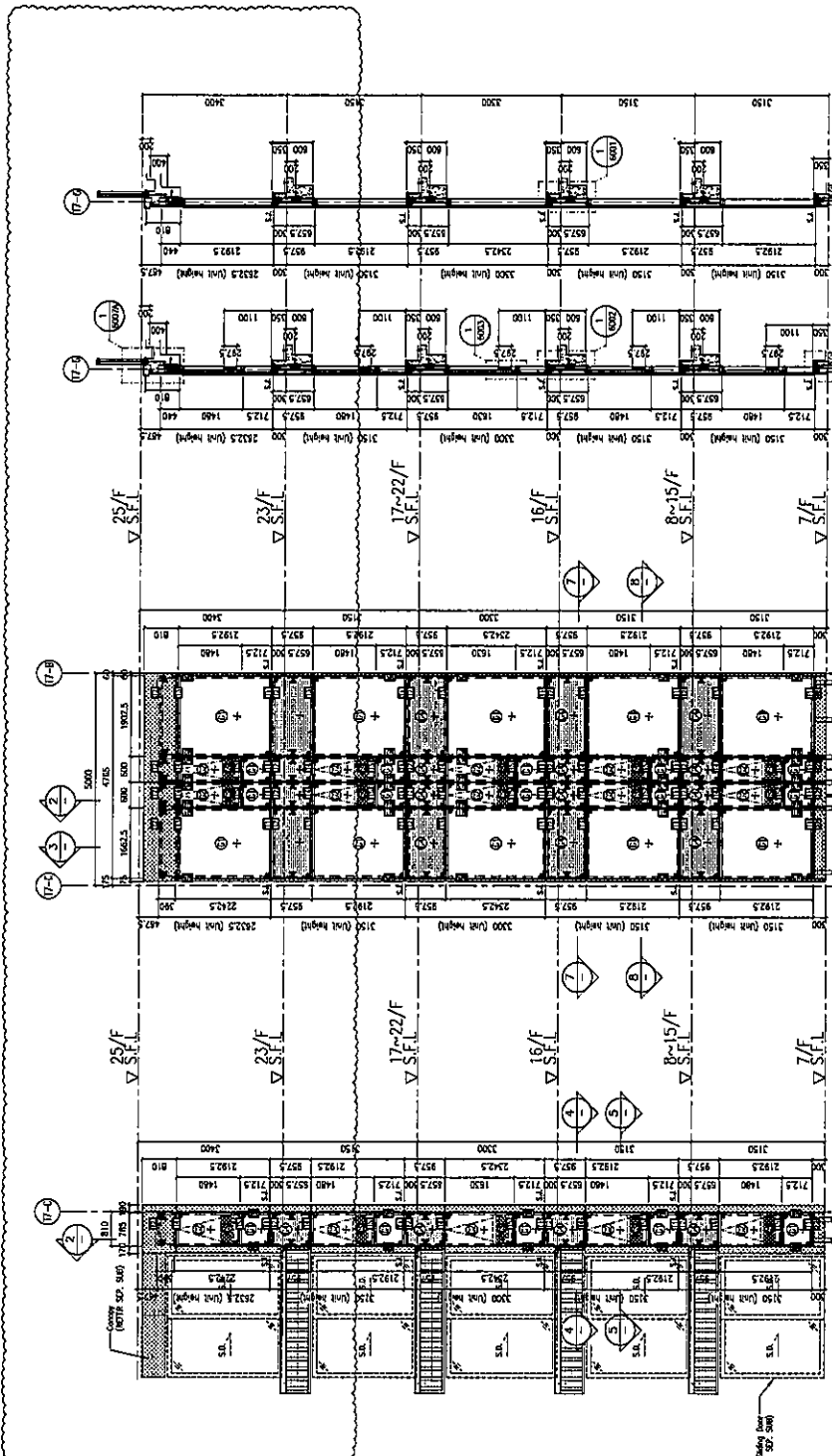

2 TYPICAL SECTION FOR CURTAIN WALL
 3 TYPICAL SECTION FOR CURTAIN WALL

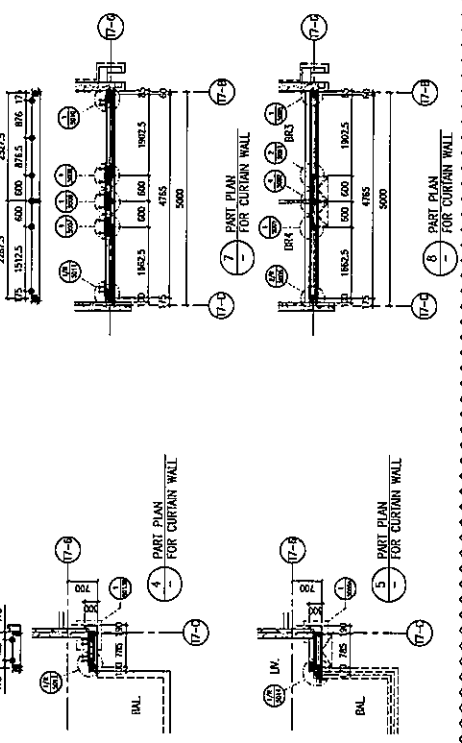

4 PART PLAN FOR CURTAIN WALL
 5 PART PLAN FOR CURTAIN WALL
 6 PART PLAN FOR CURTAIN WALL
 7 PART PLAN FOR CURTAIN WALL
 8 PART PLAN FOR CURTAIN WALL

D.D. REF :

CLIENT : SHIMAO GROUP HOLDINGS LIMITED

ARCHITECT : YONG TUNG & PARTNERS LIMITED



MAIN CONTRACTOR : 裕興建築有限公司



STRUCTURAL ENGINEER : CMA

CMA WONG & ASSOCIATES LTD

FAÇADE CONSULTANT : MEINHARDT

NOTE: 1. ALL DIMENSIONS ARE IN METERS. 2. ALL ELEVATIONS ARE VIEWED FROM OUTSIDE. 3. ALL DIMENSIONS TO BE VERIFIED ON SITE BEFORE FABRICATION.

LEGEND: 1. F.F.L. -- FINISHED FLOOR LEVEL. 2. S.F.L. -- STRUCTURAL FLOOR LEVEL. 3. (A) -- REVERSED DETAIL.

1. (A) -- RETAIN WALL NO. 2. (B) -- REFER SHEET NO.

NO.	DATE	REVISION MADE BY	REVISION CHECKED BY
1	19-10-2017
2

PROJECT : PROPOSED RESIDENTIAL DEVELOPMENT AT PKL L. 6542 YIN FING ROAD KOWLOON

TITLE : PART ELEVATION FOR CURTAIN WALL AT TOWER 6 & 7

DATE : 12-APR-21 SCALE : 1:50 (A1)

DRAWN BY : LHR CHECKED BY : ... 美特銳有限公司

FLOOR LEVEL	LEVEL
26/F	+206.760
25/F	+203.410
24/F	+200.060
23/F	+196.710
22/F	+193.360
21/F	+189.910
20/F	+186.560
19/F	+183.210
18/F	+179.860
17/F	+176.510
16/F	+173.160
15/F	+169.810
14/F	+166.460
13/F	+163.110
12/F	+159.760
11/F	+156.410
10/F	+153.060
9/F	+149.710
8/F	+146.360
7/F	+143.010

- LEGEND:
- 10mm HEAT STRENGTHENED GLASS (OUTER) + 12mm AIR SPACE + 12mm THK. TEMPERED CLEAR GLASS (INNER)
 - 10mm HEAT STRENGTHENED GLASS (OUTER) + 12mm AIR SPACE + 12mm THK. TEMPERED CLEAR GLASS (INNER)
 - 12mm THK. HEAT STRENGTHENED GLASS & 2mm THK. ALUM. BACKGAP (SPANDREL GLASS)
 - 12mm THK. CLEAR TEMPERED GLASS (INTERNAL PROTECTIVE BARRIER)
 - 3mm THK. ALUM. CLADDING
 - STACK JOINT (WIND LOAD)
 - ALUM. EXTRUSION (WIND LOAD)
 - SUPPORT POINT (WIND LOAD + DEAD LOAD)
 - SUPPORT POINT (WIND LOAD)

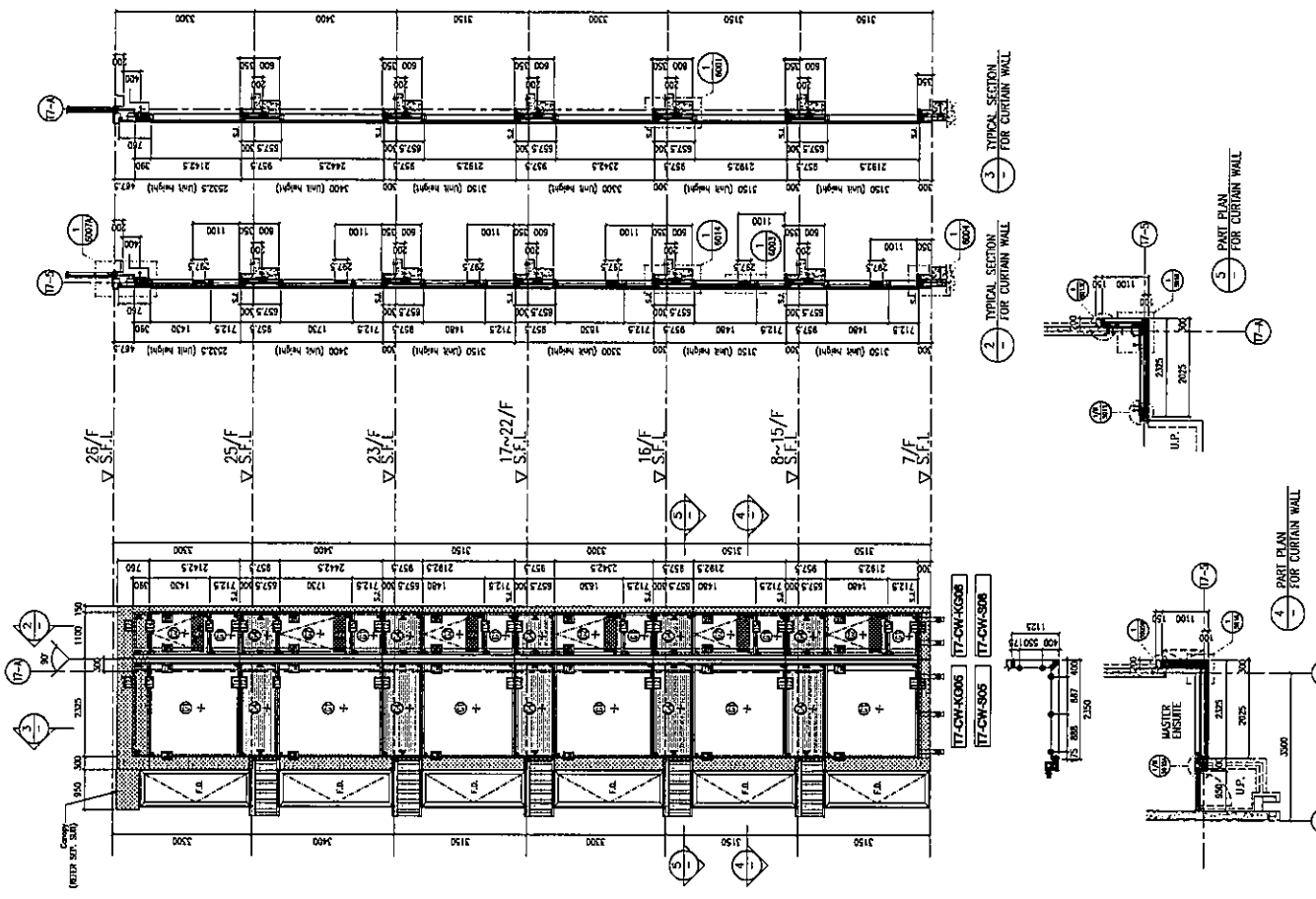

3. TYPICAL SECTION FOR CURTAIN WALL

2. TYPICAL SECTION FOR CURTAIN WALL

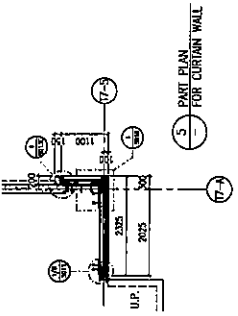

5. PART PLAN FOR CURTAIN WALL

1. PART PLAN FOR CURTAIN WALL

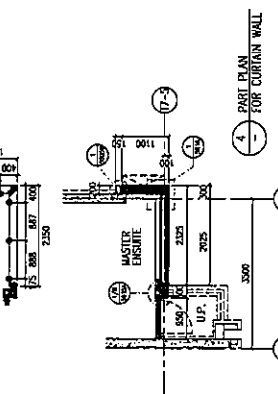

DATE: 13-APR-21

請用A3紙打印

CLIENT: SHIMAD GROUP HOLDINGS LIMITED

ARCHITECT: WONG TUNG & PARTNERS LIMITED

MAIN CONTRACTOR: 德昌建築有限公司 HEP HING CONSTRUCTION CO LTD

STRUCTURAL ENGINEER: C M WONG & ASSOCIATES LTD 黃志輝建築工程師有限公司

FRAME CONSULTANT: MEINHARDT

NOTE: 1. ALL DIMENSIONS ARE IN MM. 2. ALL ELEVATIONS ARE VIEWED FROM OUTSIDE. 3. ALL DIMENSIONS TO BE VERIFIED ON SITE BEFORE FABRICATION.

LEGEND: 1. NETAL MARK NO. 2. REFER SHEET NO. 1. F.F.L. — FINISHED FLOOR LEVEL. 2. S.F.L. — STRUCTURAL FLOOR LEVEL. 3. — REVERSED DETAIL.

PROJECT: PROPOSED RESIDENTIAL DEVELOPMENT AT N.K.L.L. 6542 YIN PING ROAD KOWLOON

JOB NO.: J-853

TITLE: PART ELEVATION FOR CURTAIN WALL AT TOWER 6 & 7

DATE: 13-APR-21 SCALE: 1:60 (A1)

DRAWN BY: LHR CHECKED BY:

PROJECT MANAGER: 黃志輝建築工程師有限公司 MIDDI ARCHITECTURE FABRICATION LTD. 1/F, 100 HING PING ROAD, KOWLOON, HONG KONG. TEL: (852) 27772668 FAX: (852) 27772668

DWG NO.: J-853-50-CW-4008 REV.: A

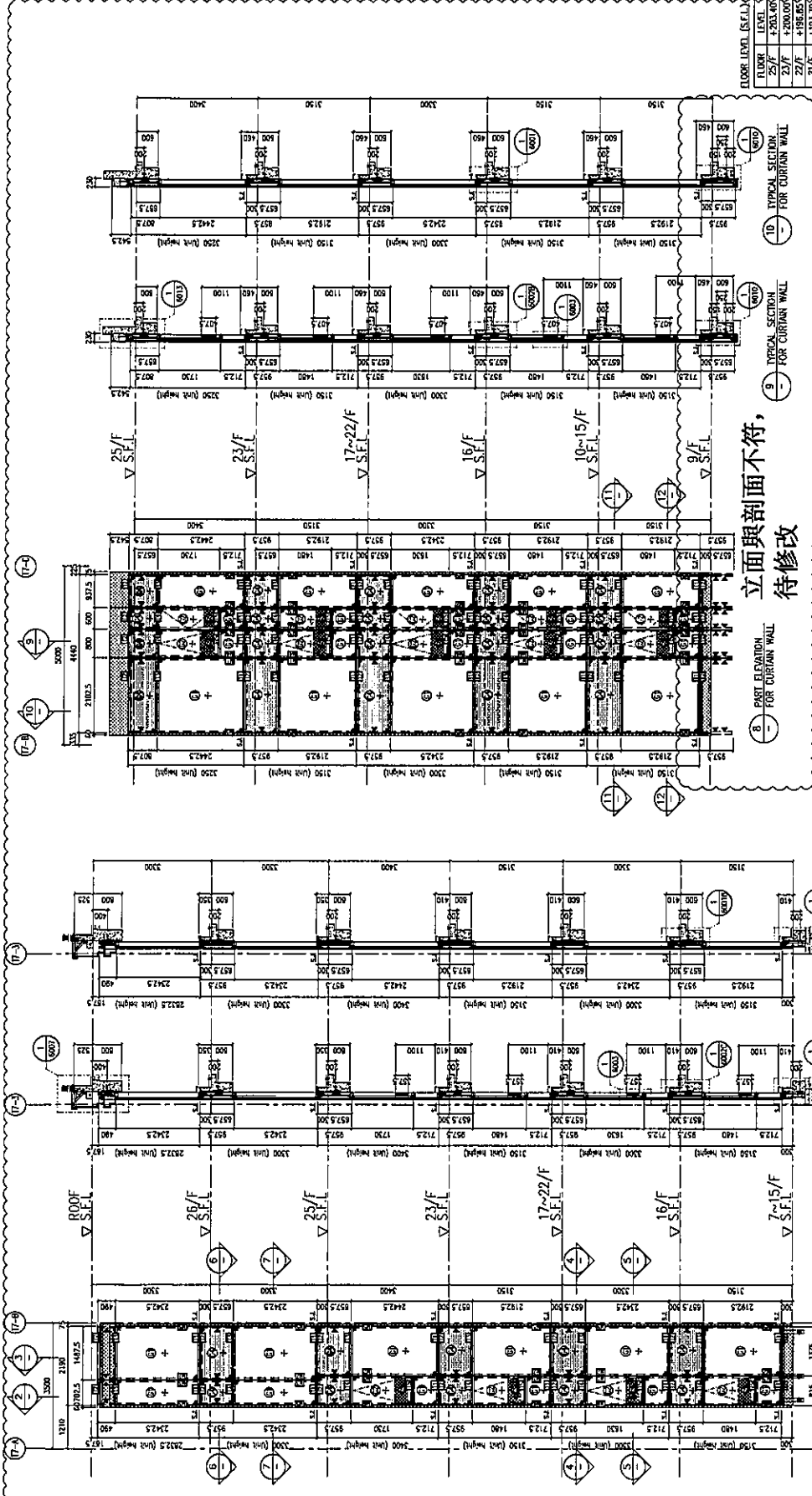

FLOOR LEVEL (S.F.L.)

FLOOR LEVEL	+202.40
25/F	+200.00
23/F	+197.60
21/F	+195.20
20/F	+192.80
19/F	+190.40
18/F	+188.00
17/F	+185.60
16/F	+183.20
15/F	+180.80
12/F	+171.20
11/F	+168.80
10/F	+166.40
9/F	+164.00
7/F	+155.75

LEGEND:

- 10mm HEAT STRENGTHENED GLASS (OUTER) + 12mm AIR SPACE + 12mm THICK TEMPERED CLEAR GLASS (INNER)
- 10mm HEAT STRENGTHENED GLASS (OUTER) + 12mm AIR SPACE + 10mm THICK TEMPERED CLEAR GLASS (INNER)
- 12mm THICK HEAT STRENGTHENED GLASS + 12mm THICK ALUM. INSPAN (SPANREL GLASS) + 12mm THICK CLEAR TEMPERED GLASS (INTERNAL PROTECTIVE BARRIER)
- 3mm THICK ALUM. CLADDING
- S.L. — STACK JOINT (WIND LOAD)
- ALUM. EXTENSION OF NO.
- SUPPORT POINT (WIND LOAD + DEAD LOAD)
- SUPPORT POINT (WIND LOAD)

