



工程指示 / 要求簡箋(E.I.)

工程指示編號：EI/443/22

修改版次：

工程編號：J-853

工程名稱：大窩坪(廷坪路)

工程項目：幕埗單元件(T5)座 起步水槽料

收件人：生統

發件人：大明

日期：17/03/2022

要求提供 / 確認 事項：

- ( ) 初步鋁料 B.M.                      ( ) 加工拆圖，然後生產                      ( ) 尺寸表
- ( ) 正式鋁料 B.M.                      ( ) 技術上資料 / 指示                      ( ) 報
- ( ) 配件 B.M.                              ( ) 樣辦或貨品說明書                      ( ) 分判合約
- ( ) 其他：\_\_\_\_\_

內容：

煩請依附件資料加工生產 幕埗 5 座單元件水槽 後送地盤安裝

請在 30/05/2022 前完成上列要求。

附有關圖紙 / 文件：附 B.M 表 頁,圖紙 31 頁

以上項目為:

- 原合約工程包                       原合約工程加 / 減脹                       新工程報價

原因：-

分發東莞各部門：

- ( )生產技術總監 連附件    ( )技術部    連附件    ( )生產部    連附件    ( )機械設計部 連附件
- ( )採購部    連附件    (✓)生產統籌部 連附件
- ( )質檢部    連附件    ( )會計部    連附件    ( )報關組    連附件    (✓)其他 謝文林 連附件

分發香港各部門：

- ( )行政部 連附件    ( )會計部 連附件    ( )統籌部 連附件    ( )工程部地盤科文 連附件
- ( )採購部 連附件    ( )QS 部 連附件    ( )維修部 連附件    (✓)其他 \_\_\_\_\_ 連附件 貴

傳遞編號：HK 0423

發件人簽署：[Signature]

項目經理簽署：[Signature]

FTP

**圖則登記表**  
DRAWING REGISTER

接收日期 Receiving Date (適用於客戶圖則)		年							
工程名稱 Project Title:		月							
T5座水槽料 (加工圖/位置圖)		日							
工程編號 Project No:									
J-853									
分發予 Distributed To									
		年	22						
		月	3						
		日	14						
圖則編號 Drg. No.	圖則名稱 Drawing Title	修訂編號 Revision No.							
J853-T5-CW-S30	水槽料拆圖	1							
J853-T5-CW-S31	水槽料拆圖	2							
J853-T5-CW-S32a	水槽料拆圖	3							
J853-T5-CW-S32b	水槽料拆圖	4							
J853-T5-CW-S33a	水槽料拆圖	5							
J853-T5-CW-S33b	水槽料拆圖	6							
J853-T5-CW-S34	水槽料拆圖	7							
J853-T5-CW-S35	水槽料拆圖	8							
J853-T5-CW-S36	水槽料拆圖	9							
J853-T5-CW-S37	水槽料拆圖	10							
J853-T5-CW-S38	水槽料拆圖	11							
J853-T5-CW-S39	水槽料拆圖	12							
J853-T5-CW-S40	水槽料拆圖	13							
J853-T5-CW-S41	水槽料拆圖	14							
J853-T5-CW-S42	水槽料拆圖	15							
J853-T5-CW-S43	水槽料拆圖	16							
J853-T5-CW-S44	水槽料拆圖	17							
J853-T5-CW-S45a	水槽料拆圖	18							

/

圖則登記表  
DRAWING REGISTER

圖則登記表 DRAWING REGISTER		接收日期 Receiving Date (適用於客戶圖則)						
工程名稱 Project Title:	九龍延坪道 T5座水槽料 (加工圖/位置圖)	年	月	日	時	分	秒	
工程編號 Project No:	J-853							
分發予 Distributed To								
		年	22					
		月	3					
		日	14					
圖則編號 Drg. No.	圖則名稱 Drawing Title		修訂編號 Revision No.					
J853-T5-CW-S45b	水槽料拆圖	19						
J853-T5-CW-S46	水槽料拆圖	20						
J853-T5-CW-S47a	水槽料拆圖	21						
J853-T5-CW-S47b	水槽料拆圖	22						
J853-T5-CW-S48a	水槽料拆圖	23						
J853-T5-CW-S48b	水槽料拆圖	24						
J853-T5-CW-S49a	水槽料拆圖	25						
J853-T5-CW-S49b	水槽料拆圖	26						
J853-T5-CW-S49c	水槽料拆圖	27						
J853-T5-CW-S50	水槽料拆圖	28						
J853-T5-CW-S51	水槽料拆圖	29						
CW-GL01	封口片拆圖	30						
CW-GL02	封口墊片拆圖	31						
J853-T5-CW-KG30~40	扣蓋拆圖	32						
J853-T5-CW-KG41	扣蓋拆圖	33						
J853-T5-CW-KG42	扣蓋拆圖	34						
J853-T5-CW-KG43~51	扣蓋拆圖	35						
J853-T5-CW-KG43~51a	扣蓋拆圖(數據表)	36						

**圖則登記表**  
DRAWING REGISTER

接收日期 Receiving Date (適用於客戶圖則)		年							
年		月							
日		日							
工程名稱 Project Title: <b>九龍延坪道</b>		年	月	日					
T5座水槽料 (加工圖/位置圖)									
工程編號 Project No: J-853		年	月	日					
分發予 Distributed To									
		22							
		3							
		14							
圖則編號 Drg. No.	圖則名稱 Drawing Title	修訂編號 Revision No.							
J853-SD-CW-4501	水槽料/扣蓋位置圖	37							
J853-SD-CW-4502	水槽料/扣蓋位置圖	38							
J853-SD-CW-4503	水槽料/扣蓋位置圖	39							
J853-SD-CW-4504	水槽料/扣蓋位置圖	40							
J853-SD-CW-4505	水槽料/扣蓋位置圖	41							
J853-SD-CW-4506	水槽料/扣蓋位置圖	42							
J853-SD-CW-4507	水槽料/扣蓋位置圖	43							
J853-SD-CW-4508	水槽料/扣蓋位置圖	44							
J853-SD-CW-4509	水槽料/扣蓋位置圖	45							

















數量: 1

**美特鋁質有限公司**  
MIDI Aluminium Fabricator Ltd.

工程號 J853 地盤 延坪道

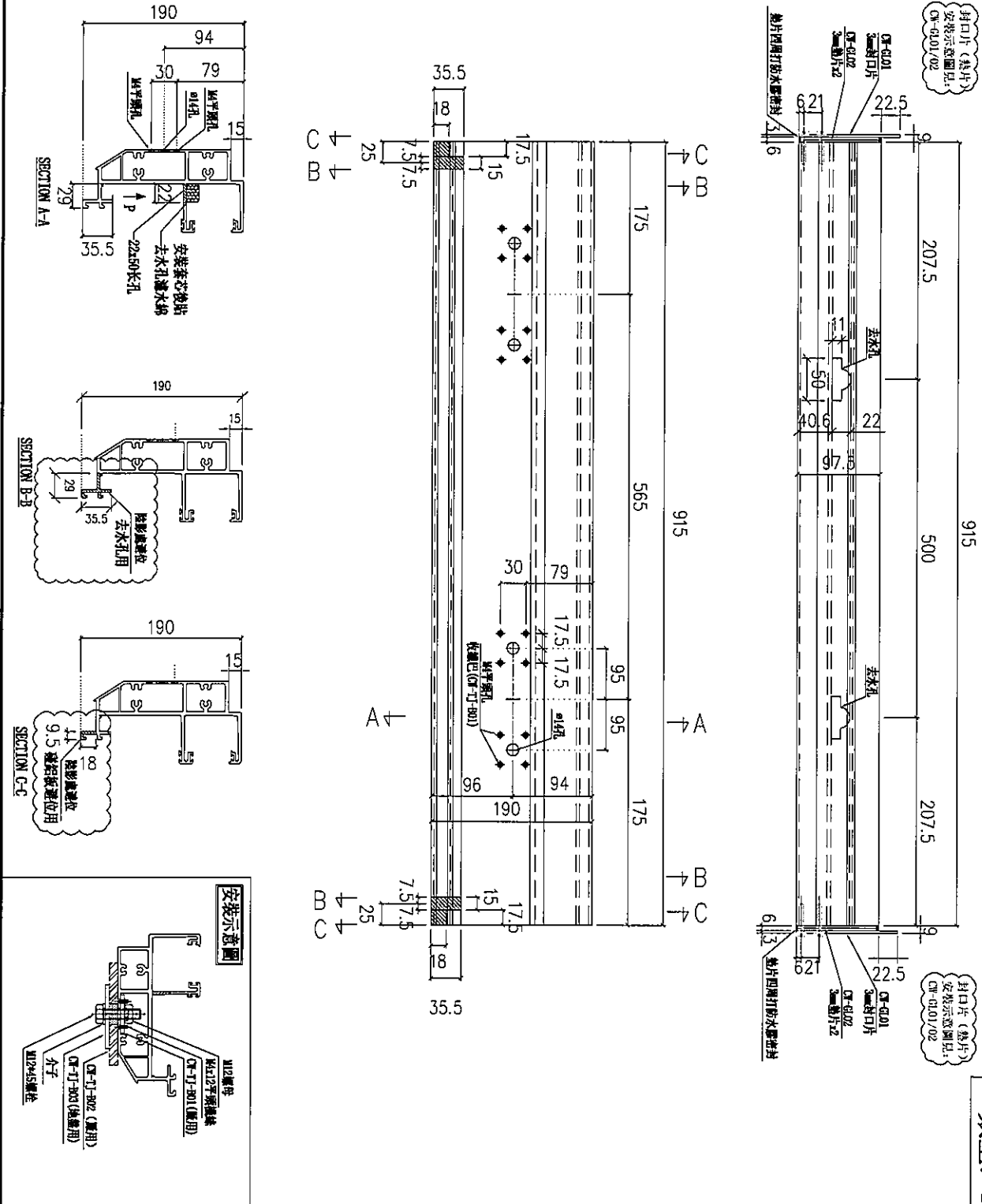

名稱	頂橫	制圖	陳敏聰	2022.03.01	修改
材料	X85982	復核	謝永林	2022.03.12	日期
顏色	JMQ213457(3 coatings)	批准			圖號
					J853-T5-CW-S36



美特鋁質有限公司  
MIDI Aluminium Fabricator Ltd.

工程號 J853 地盤 延坪道

請用A3紙打印

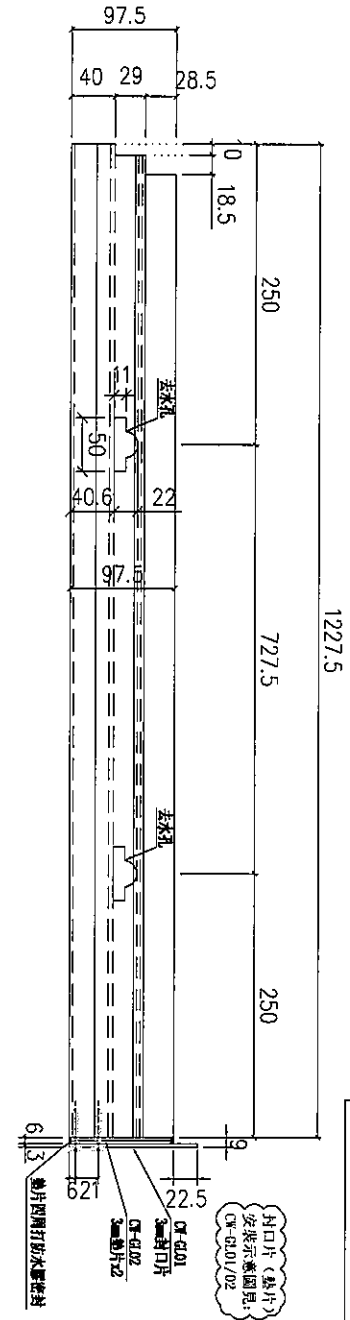
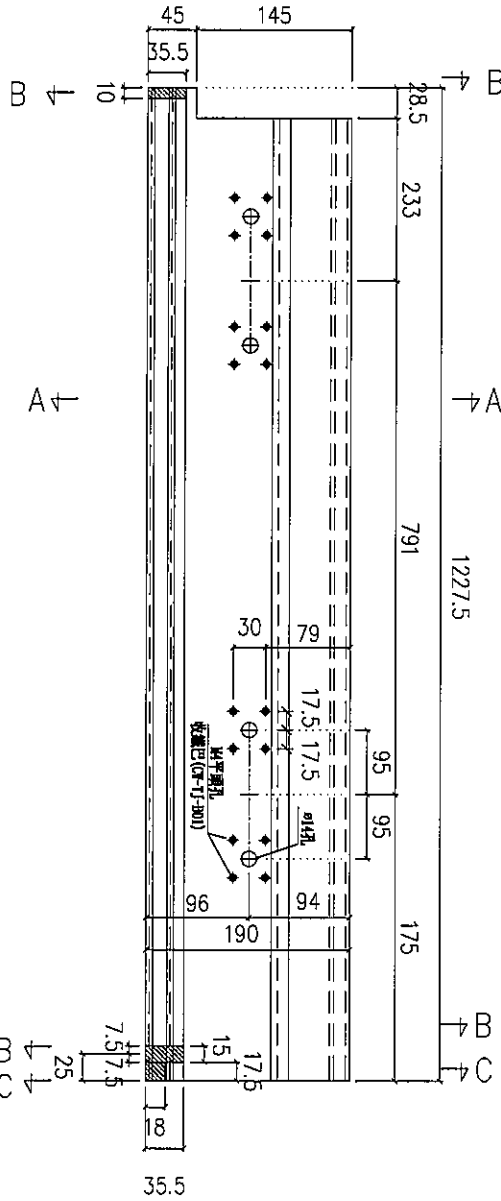
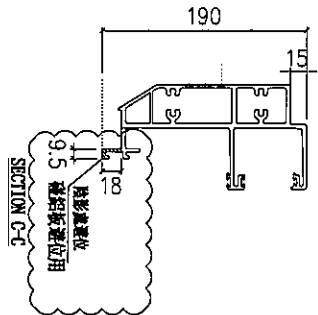
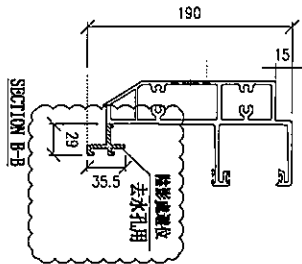
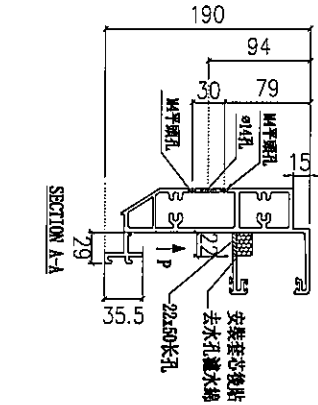

數量: 1

使用位置 J853-SD-CW-4504

名稱	頂橫	制圖	陳敏聰	2022.03.01	修改		
材料	X85982	復核	謝永林	2022.03.12	日期		
顏色	JMQ213457(3 coatings)	批准			圖號	J853-T5-CW-S37	











請用A3紙打印

使用位置 J853-SD-CW-4506

數量: 1

封口片 (墊片)  
安裝示意圖見:  
CW-0101/02

封口片 (墊片)  
安裝示意圖見:  
CW-0101/02

**美特鋁質有限公司**  
MIDI Aluminium Fabricator Ltd.

工程號	J853	地盤	延坪道
-----	------	----	-----

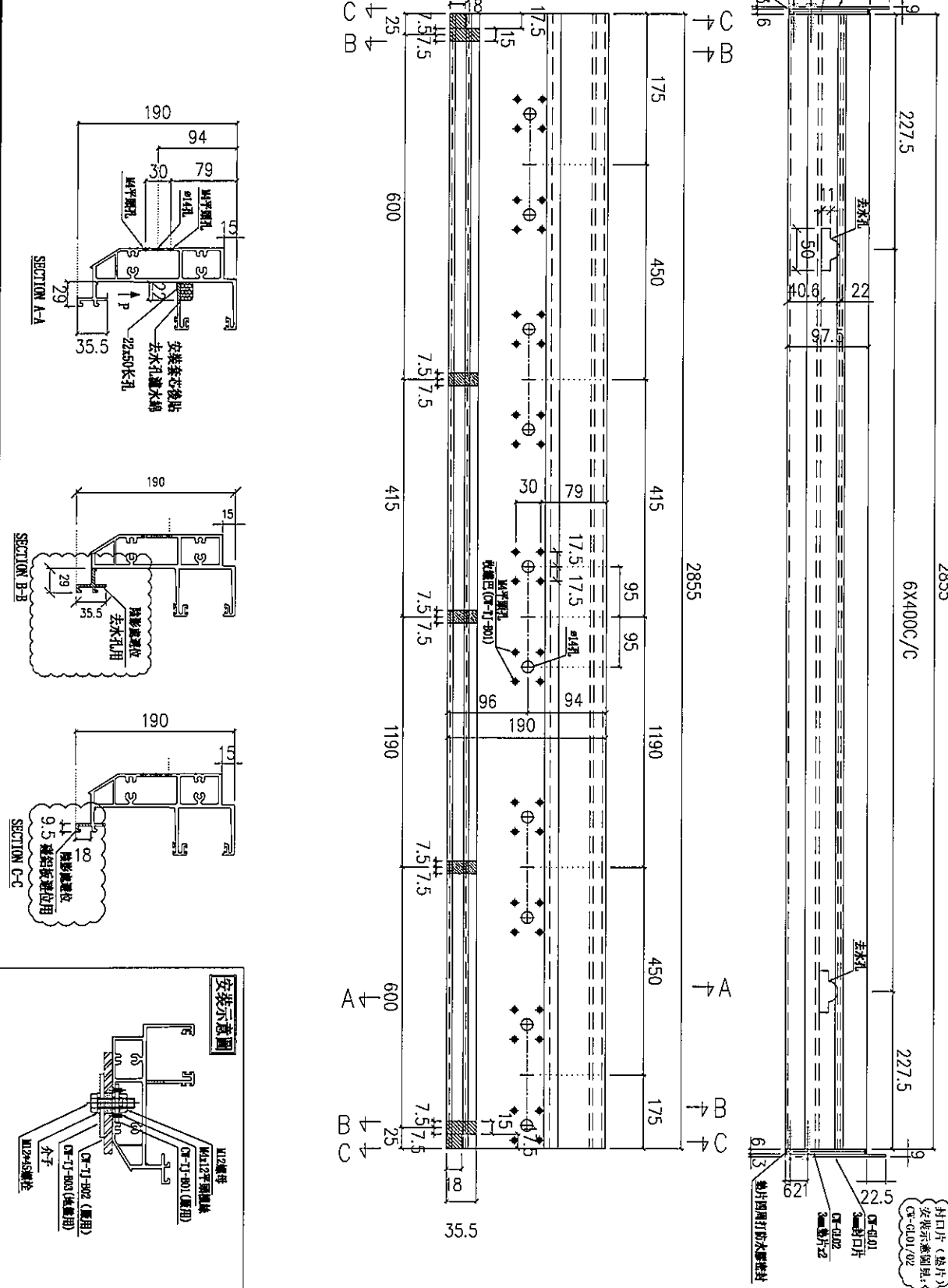

名稱	頂橫	制圖	陳敏聰	2022.03.01	修改
材料	X85982	復核	謝永林	2022.03.12	日期
顏色	JMQ213457(3 coatings)	批准			圖號
					J853-T5-CW-S43



















請用A3紙打印

使用位置 J853-SD-CW-4509

數量: 1

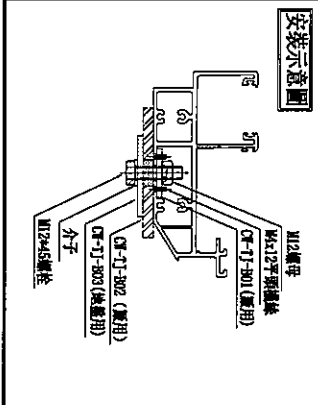
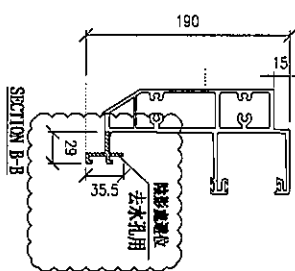
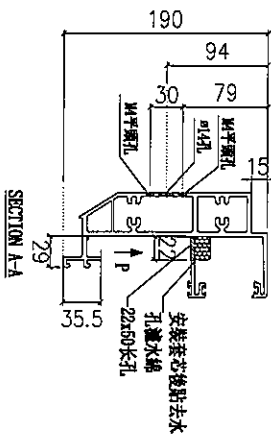
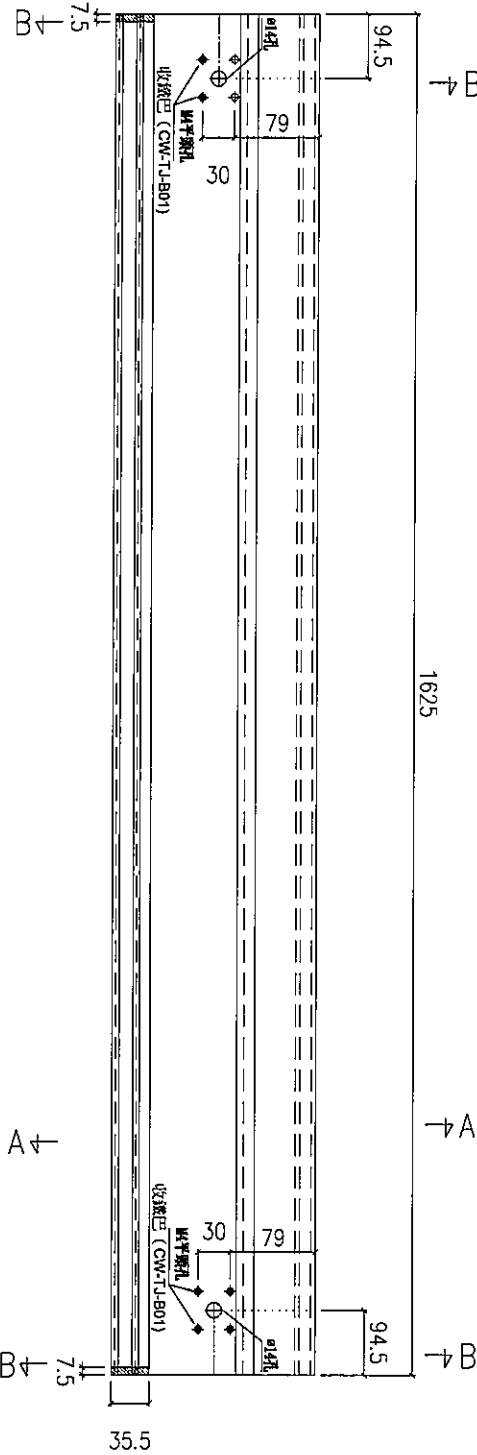
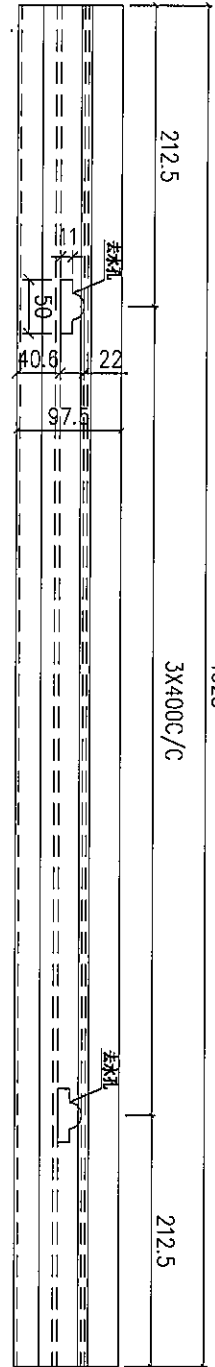

名稱	頂橫	制圖	陳敏聰	2022.03.01	修改	
材料	X85982	復核	謝永林	2022.03.12	日期	
顏色	JMQ213457(3 coatings)	批准			圖號	J853-T5-CW-S49b







 美特鋁質有限公司  
MIDI Aluminium Fabricator Ltd.

工程號 J853 地盤 延坪道

物料編號  
CW-GL01

數量  
42

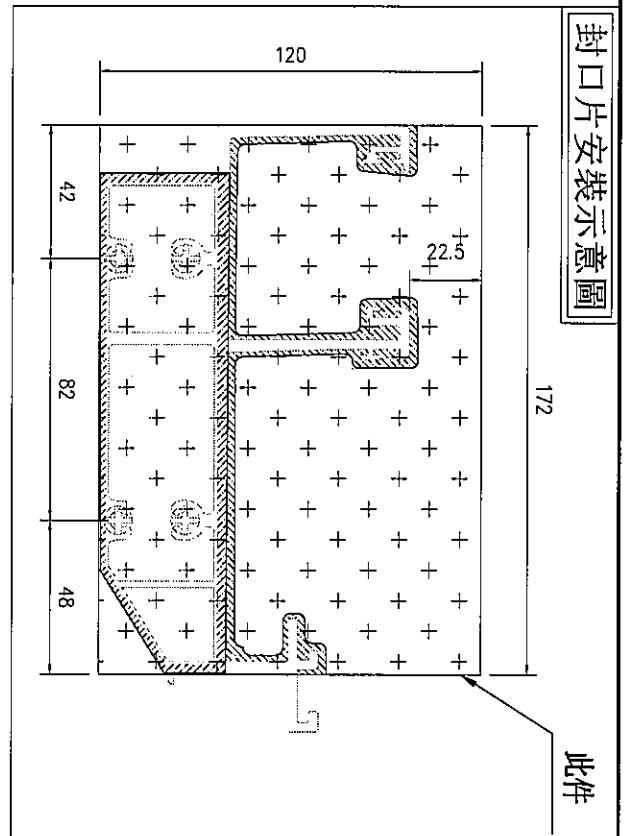
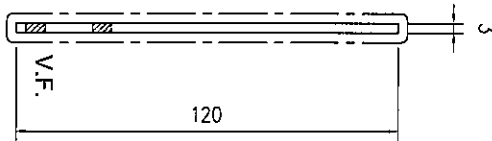
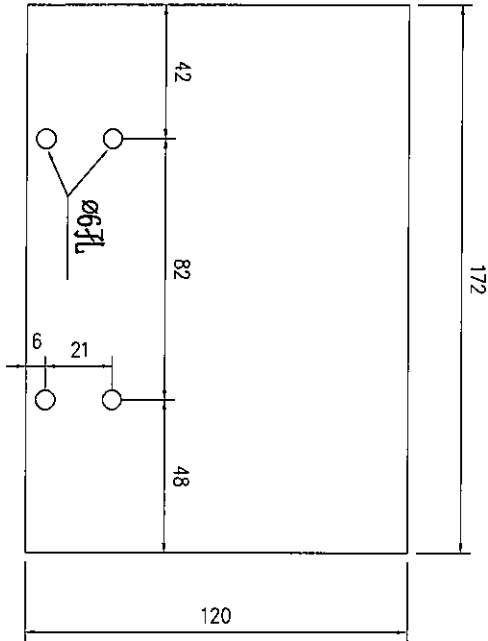

名稱	封口片	制圖	謝曉云	2021.12.03	修改		
材料	3mm鋁板	復核	謝永林	2021.12.08	日期		
顏色	EC-DG-D334232-ZD1	批准	Daniel		圖號	CW-GL01	

美特鋁質有限公司  
MIDI Aluminium Fabricator Ltd.

工程號 J853 地盤 延坪道

物料編號  
CW-GL02  
數量  
84

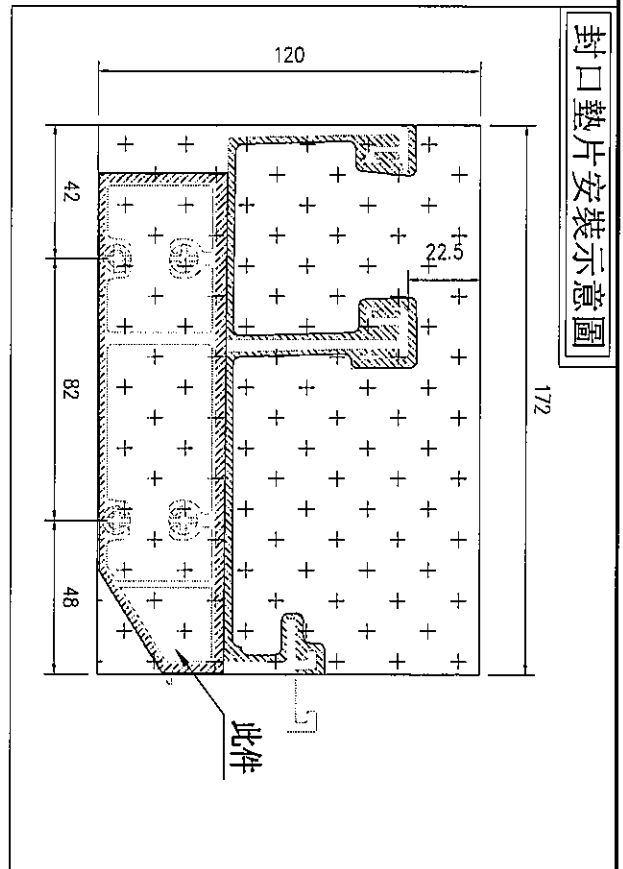
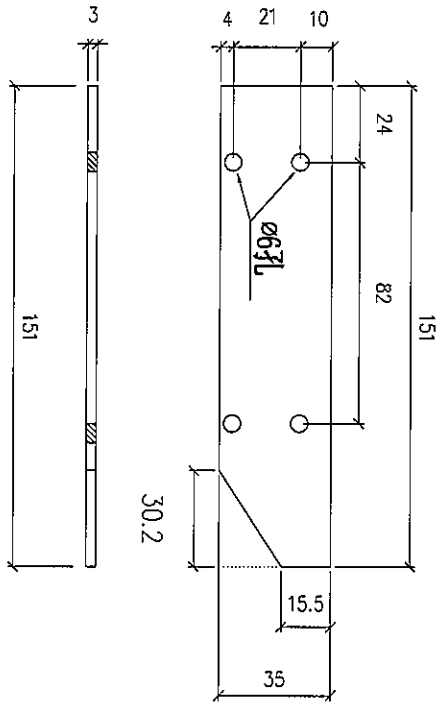

封口墊片安裝示意圖

名稱	封口墊片	制圖	謝曉云	2021.12.03	修改		
材料	3mm鋁板	復核	謝永林	2021.12.08	日期		
顏色	MILL	批准	Daniel		圖號	CW-GL02	

工程號 J853 地盤 延坪道

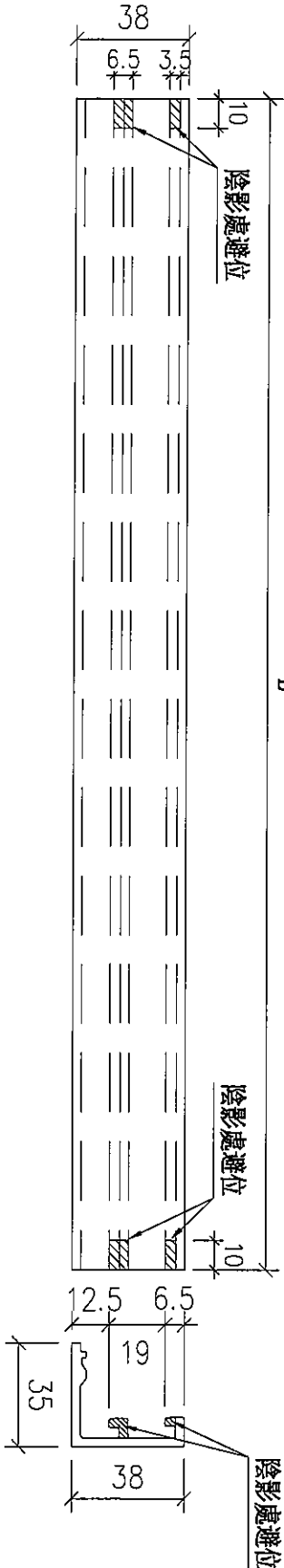

圖號	扣蓋長度(L)	分格寬度	數量	使用位置
T5-CW-KG30	1185	1200	1	J853-SD-CW-4501
T5-CW-KG31	1022.5	1037.5	1	J853-SD-CW-4501
T5-CW-KG32a	1037.5	1052.5	1	J853-SD-CW-4501
T5-CW-KG32b	585	600	1	J853-SD-CW-4501
T5-CW-KG32c	897.5	912.5	1	J853-SD-CW-4501
T5-CW-KG32d	585	600	1	J853-SD-CW-4501
T5-CW-KG33a	1497.5	1512.5	1	J853-SD-CW-4502
T5-CW-KG33b	585	600	1	J853-SD-CW-4502
T5-CW-KG33c	1135	1150	1	J853-SD-CW-4502
T5-CW-KG34a	685	700	1	J853-SD-CW-4503
T5-CW-KG34b	585	600	1	J853-SD-CW-4503
T5-CW-KG35a	585	600	1	J853-SD-CW-4504
T5-CW-KG35b	975	990	1	J853-SD-CW-4504
T5-CW-KG36	850	865	1	J853-SD-CW-4504
T5-CW-KG37	1185	1200	1	J853-SD-CW-4504
T5-CW-KG38	650	665	1	J853-SD-CW-4505
T5-CW-KG39	2285	2300	1	J853-SD-CW-4505
T5-CW-KG40	470	485	1	J853-SD-CW-4505

名稱	玻璃扣蓋	制圖	陳敏聰	2022.03.02	修改		
材料	X85989	復核	謝永林	2022.03.12	日期		
顏色	JMQ213457(3 coatings)	批准			圖號	J853-T5-CW-KG30~40	



美特鋁質有限公司  
MIDI Aluminium Fabricator Ltd.

工程號 J853 地盤 延坪道

圖號	扣蓋長度(L)	分格寬度	數量	使用位置
T5-CW-KG41	1016	1025	1	J853-SD-CW-4506

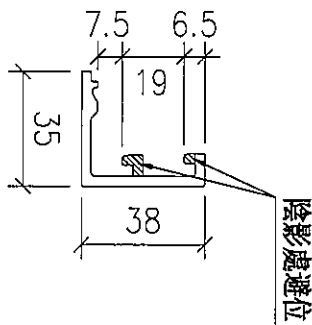
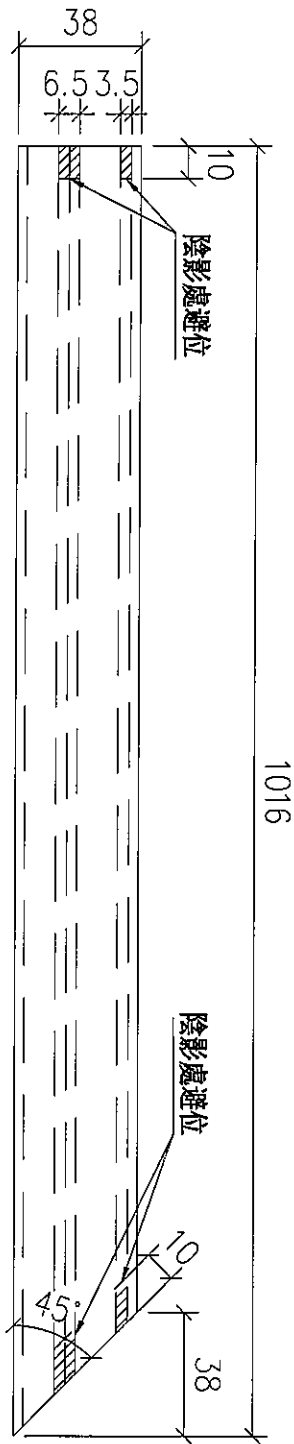

名稱	玻璃扣蓋	制圖	陳敏聰	2022.03.02	修改		
材料	X85989	復核	謝永林	2022.03.12	日期		
顏色	JMQ213457(3 coatings)	批准			圖號	J853-T5-CW-KG41	



美特鋁質有限公司  
MIDI Aluminium Fabricator Ltd.

工程號 J853 地盤 延坪道

圖號	扣蓋長度(L)	分格寬度	數量	使用位置
T5-CW-KG42	1006	1015	1	J853-SD-CW-4506

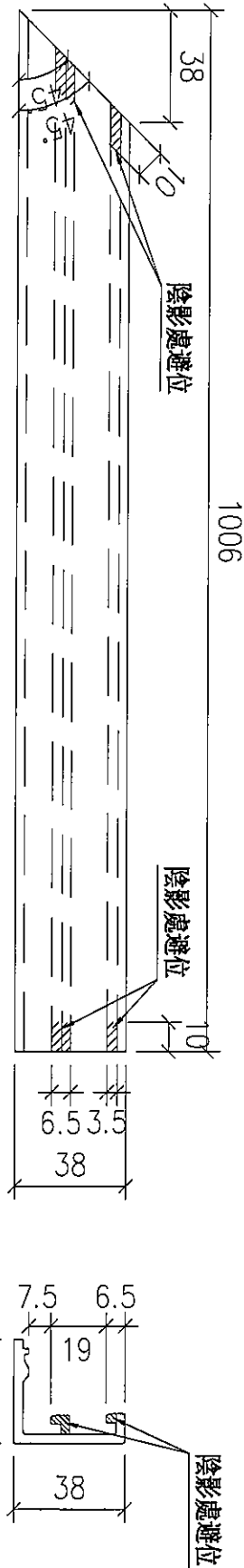

名稱	玻璃扣蓋	制圖	陳敏聰	2022.03.02	修改		
材料	X85989	復核	謝永林	2022.03.12	日期		
顏色	JMQ213457(3 coatings)	批准			圖號	J853-T5-CW-KG42	



美特鋁質有限公司  
MIDI Aluminium Fabricator Ltd.

工程號 J853 地盤 延坪道

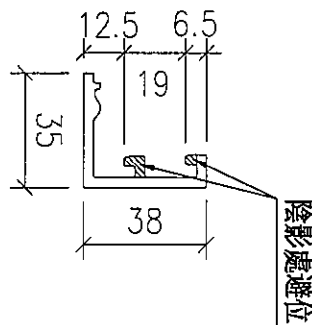
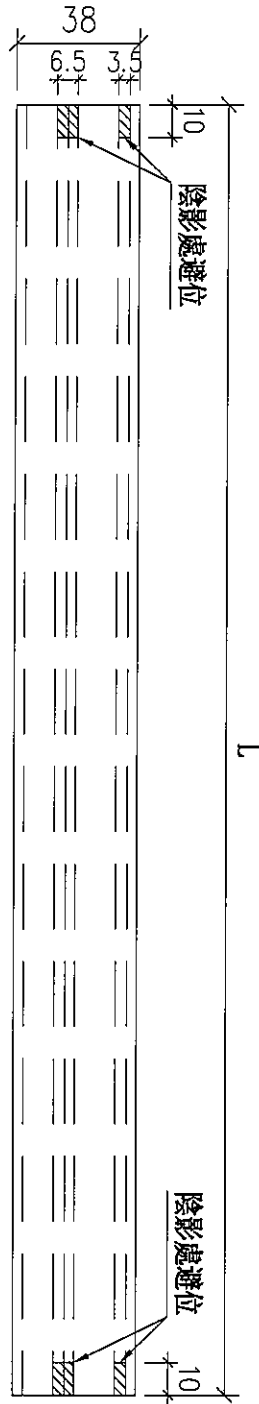

數據詳情參考圖號  
J853-T5-CW-KG43~51a

名稱	玻璃扣蓋	制圖	陳敏聰	2022.03.02	修改		
材料	X85989	復核	謝永林	2022.03.12	日期		
顏色	JMQ213457(3 coatings)	批准			圖號	J853-T5-CW-KG43~51	



美特鋁質有限公司  
MIDI Aluminium Fabricator Ltd.

工程號 J853 地盤 延坪道

圖號	扣蓋長度(L)	分格寬度	數量	使用位置
T5-CW-KG43a	585	600	1	J853-SD-CW-4506
T5-CW-KG43b	1590	1605	1	J853-SD-CW-4506
T5-CW-KG43c	585	600	1	J853-SD-CW-4506
T5-CW-KG44a	1765	1780	1	J853-SD-CW-4506
T5-CW-KG44b	585	600	1	J853-SD-CW-4506
T5-CW-KG45a	1247.5	1262.5	1	J853-SD-CW-4507
T5-CW-KG45b	585	600	1	J853-SD-CW-4507
T5-CW-KG45c	585	600	1	J853-SD-CW-4507
T5-CW-KG45d	1522.5	1537.5	1	J853-SD-CW-4507
T5-CW-KG46	1185	1200	1	J853-SD-CW-4508
T5-CW-KG47a	1172.5	1187.5	1	J853-SD-CW-4508
T5-CW-KG47b	585	600	1	J853-SD-CW-4508
T5-CW-KG47c	585	600	1	J853-SD-CW-4508
T5-CW-KG47d	1172.5	1187.5	1	J853-SD-CW-4508
T5-CW-KG48a	1172.5	1187.5	1	J853-SD-CW-4508
T5-CW-KG48b	585	600	1	J853-SD-CW-4508
T5-CW-KG48c	585	600	1	J853-SD-CW-4508
T5-CW-KG48d	1097.5	1112.5	1	J853-SD-CW-4508
T5-CW-KG49a	972.5	987.5	1	J853-SD-CW-4509
T5-CW-KG49b	1085	1100	1	J853-SD-CW-4509
T5-CW-KG49c	1610	1625	1	J853-SD-CW-4509
T5-CW-KG49d	1972.5	1987.5	1	J853-SD-CW-4509
T5-CW-KG50a	1080	1095	1	J853-SD-CW-4509
T5-CW-KG50b	1080	1095	1	J853-SD-CW-4509
T5-CW-KG51a	485	500	1	J853-SD-CW-4509
T5-CW-KG51b	700	715	1	J853-SD-CW-4509

名稱	玻璃扣蓋(數據表)	制圖	陳敏聰	2022.03.02	修改		
材料	X85989	復核	譚永林	2022.03.12	日期		
顏色	JMQ213457(3 coatings)	批准			圖號	J853-T5-CW-KG43~51a	

B.O. REF :

請用A3紙打印

**CLIENT :** SHIMAO GROUP HOLDINGS LIMITED

**ARCHITECT :** YOUNG LUNG & PARTNERS LIMITED

**MAIN CONTRACTOR :** 協興建築有限公司 / HP HING CONSTRUCTION CO. LTD

**STRUCTURAL ENGINEER :** CMA CHONG & ASSOCIATES LTD / 黃志明建築工程師有限公司

**PACKAGE CONSULTANT :** MEINHARDT

**NOTE:**  
 1. ALL DIMENSIONS ARE IN MM.  
 2. ALL ELEVATIONS ARE VIEWED FROM OUTSIDE.  
 3. ALL DIMENSIONS TO BE VERIFIED ON SITE BEFORE FABRICATING.

**LEGEND:**  
 (1) DETAIL WORK NO.  
 (2) WATER SHEET NO.  
 1. F.F.L. — FINISHED FLOOR LEVEL  
 2. S.F.L. — STRUCTURAL FLOOR LEVEL  
 3. (R) — REVERSED DETAIL

**JOB NO. :** J-053

**PROJECT :** PROPOSED RESIDENTIAL DEVELOPMENT AT N.K.L.L. 6542 YIN PING ROAD, KOWLOON

**TITLE :** PART ELEVATION FOR CURTAIN WALL AT TOWER 5

**DATE :** 31-MAR-21 **SCALE :** 1:60 (A1)

**DRAWN BY :** LHR **CHECKED BY :**

**美特銳有限公司**  
 MTDI ARCHITECTURAL MANUFACTURE LTD.  
 16th F-5, Sunny Industrial Centre, 1/F  
 142,240,241-1, Yue Kee Road, Tseung Kwan O, New Territories, Hong Kong  
 TEL: (852) 27272666

**DWG. NO. :** 0533-SD-CW-4301 **REV. :** A

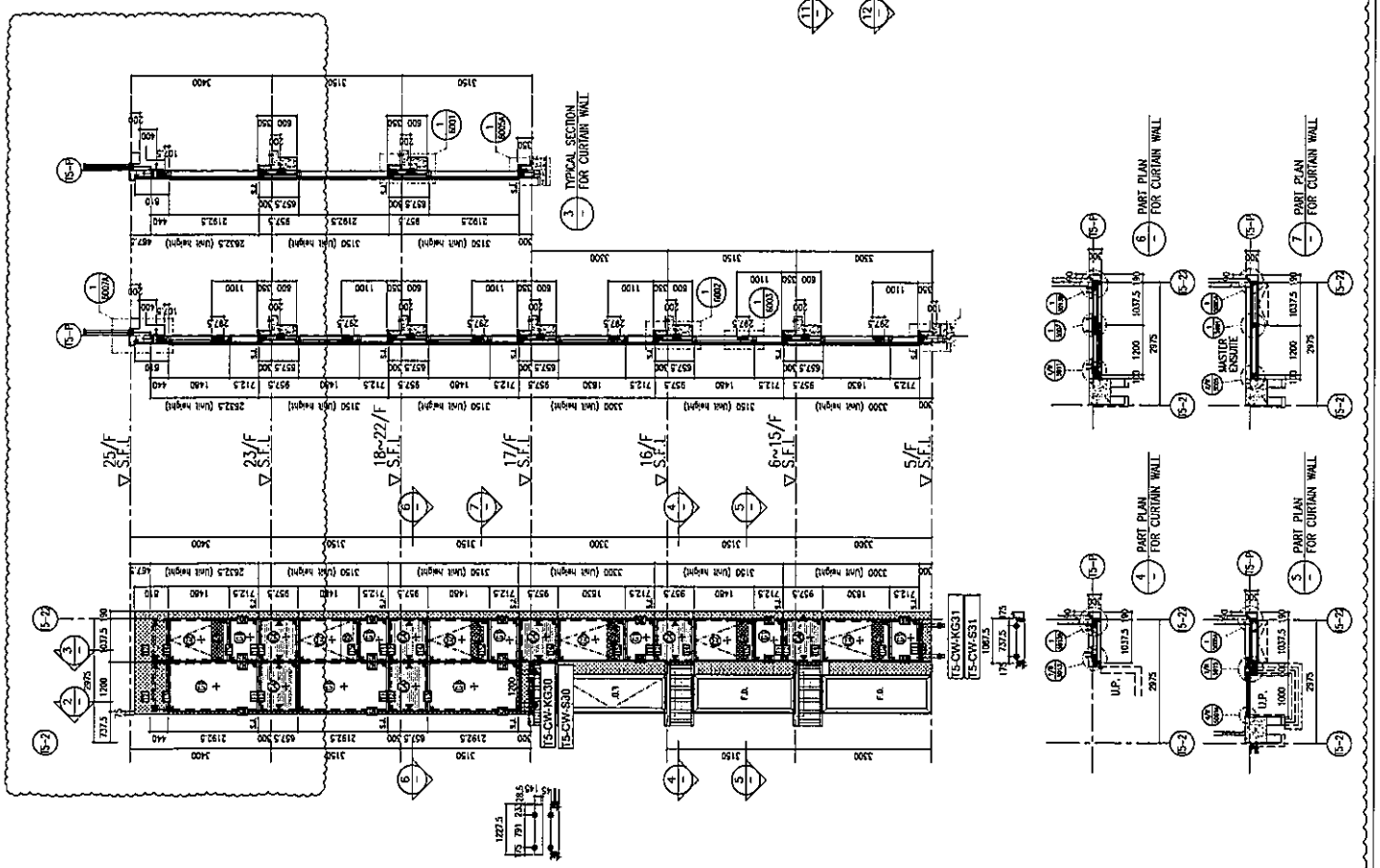

**FLOOR LEVEL (S.F.L.)**

FLOOR	LEVEL
25/F	2283.40
24/F	2283.40
23/F	2196.85
22/F	2196.85
21/F	2196.85
20/F	2196.85
19/F	2196.85
18/F	2196.85
17/F	2196.85
16/F	2196.85
15/F	2196.85
14/F	2196.85
13/F	2196.85
12/F	2196.85
11/F	2196.85
10/F	2196.85
9/F	2196.85
8/F	2196.85
7/F	2196.85
6/F	2196.85
5/F	2196.85

- LEGEND:**
- ① 10mm HEAT STRENGTHENED GLASS (QUIET) + 12mm AIR SPACE + 12mm THK. TEMPERED CLEAR GLASS (INNER)
  - ② 10mm HEAT STRENGTHENED GLASS (QUIET) + 12mm AIR SPACE + 10mm THK. TEMPERED CLEAR GLASS (INNER)
  - ③ 12mm THK. HEAT STRENGTHENED GLASS & 2mm THK. ALUM. JACKPAN (SPANDREL GLASS)
  - ④ 12mm THK. CLEAR TEMPERED GLASS (INTERNAL PROTECTIVE BARRIER)
  - ⑤ 3mm THK. ALUM. CLADDING
  - S.L. — STACK JOINT (WIND LOAD)
  - ⑥ — ALUM. EXTRUSION (WIND LOAD)
  - ▲ — SUPPORT POINT (WIND LOAD + DEAD LOAD)
  - — SUPPORT POINT (WIND LOAD)

**SHIMAO GROUP HOLDINGS LIMITED**  
**SHIMAO GROUP HOLDINGS LIMITED**  
 新加坡及香港有限公司  
 SINGAPORE & HONG KONG LIMITED

**MAIN CONTRACTOR:**  
**協興建築有限公司**  
 HOP HING CONSTRUCTION CO. LTD.

**STRUCTURAL ENGINEER:**  
**C H WONG & ASSOCIATES LTD**  
 黃志偉建築工程師有限公司  
**CHWA**

**PACKAGE CONSULTANT:**  
**WEINHARDT**

**NOTE:**  
 1. DIMENSIONS ARE IN MM.  
 2. ALL ELEVATIONS ARE VIEWED FROM OUTSIDE.  
 3. ALL DIMENSIONS TO BE VERIFIED ON SITE BEFORE FABRICATION.

**LEGEND:**  
 1. F.F.L. --- FINISHED FLOOR LEVEL  
 2. S.F.L. --- STRUCTURAL FLOOR LEVEL  
 3. --- REVERSED DETAIL

**ACTUAL WORK NO.**  
**REFER SHEET NO.**

**JOB NO.:** J-853  
**PROJECT:** PROPOSED RESIDENTIAL DEVELOPMENT AT N.K.L.L. 0542 YIN PING ROAD KOWLOON

**TITLE:** PART ELEVATION FOR CURTAIN WALL AT TOWER 5

**DRAWN BY:** UHR  
**CHECKED BY:**  
**DATE:** 31-MAR-21  
**SCALE:** 1:80 (A1)

**DESIGNED BY:** UHR  
**DATE:** 14-FEB-21  
**SCALE:** 1:80 (A1)

**REV. A**

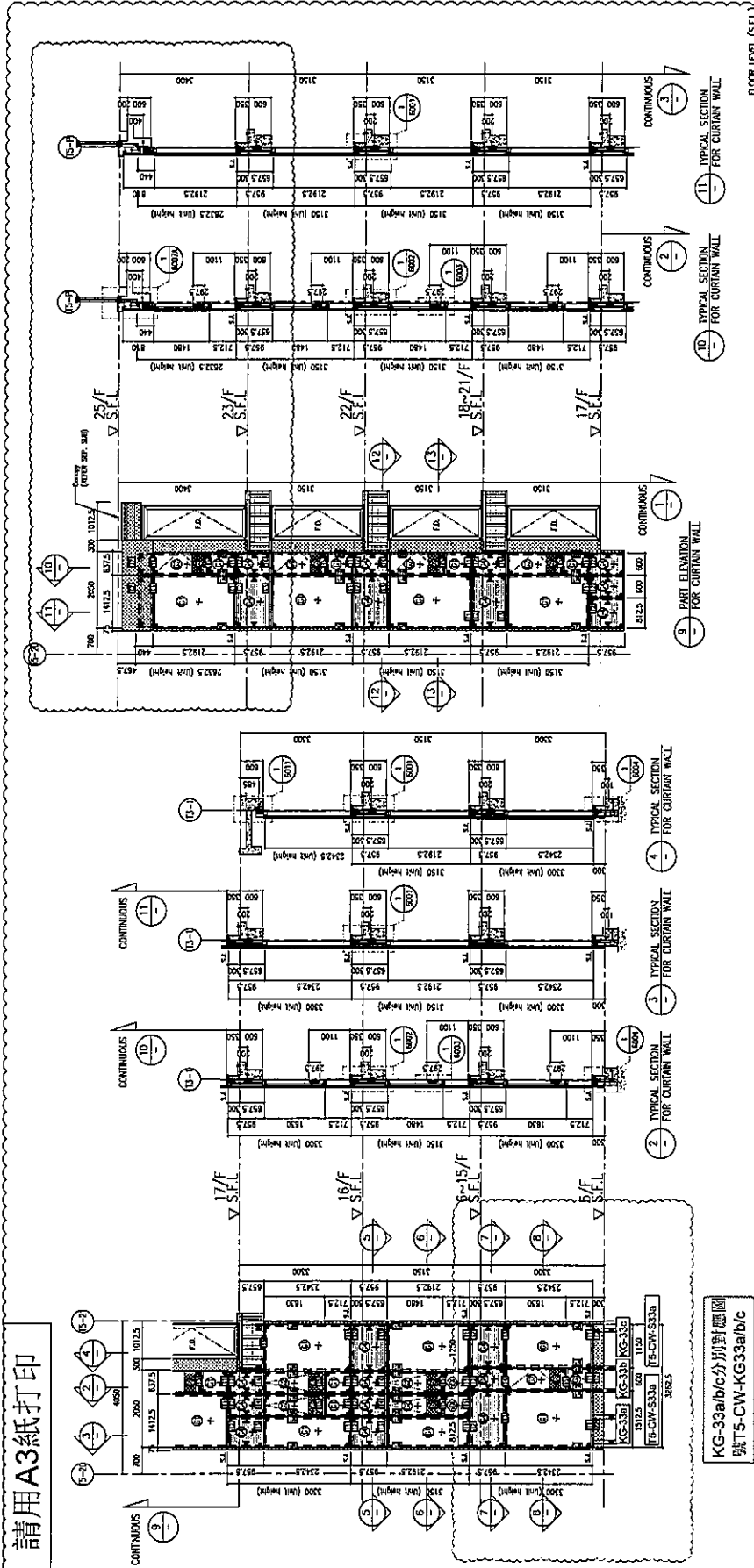

**FLOOR LEVEL (S.F.L.)**

FLOOR	LEVEL
22/F	220.00
21/F	190.00
20/F	180.00
19/F	170.00
18/F	160.00
17/F	150.00
16/F	140.00
15/F	130.00
14/F	120.00
13/F	110.00
12/F	100.00
11/F	90.00
10/F	80.00
9/F	70.00
8/F	60.00
7/F	50.00
6/F	40.00
5/F	30.00

**LEGEND:**

- 10mm HEAT STRENGTHENED GLASS (OUTER) + 12mm AIR SPACE + 12mm THK. TEMPERED CLEAR GLASS (INNER)
- 10mm HEAT STRENGTHENED GLASS (OUTER) + 12mm AIR SPACE + 12mm THK. TEMPERED CLEAR GLASS (INNER)
- 12mm THK. HEAT STRENGTHENED GLASS & 2mm THK. ALUM. BACKWASH (SPANDREL GLASS)
- 12mm THK. CLEAR TEMPERED GLASS (INTERNAL PROTECTIVE BARRIER)
- 3mm THK. ALUM. GLAZING
- S.J. - STACK JOINT (WIND LOAD)
- A.U.K. - ALUM. EXTRUSION DE. NO.
- SUPPORT POINT (WIND LOAD + 50% LWD)
- SUPPORT POINT (WIND LOAD)

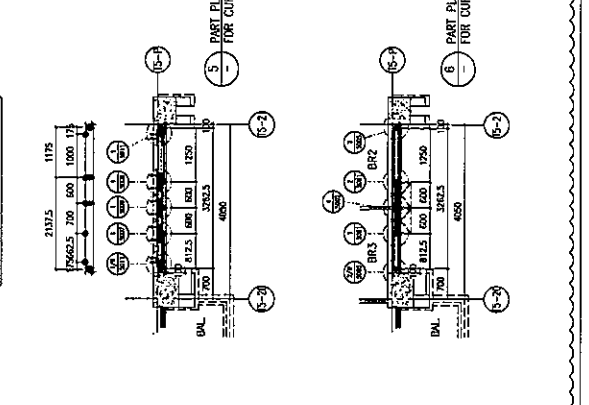
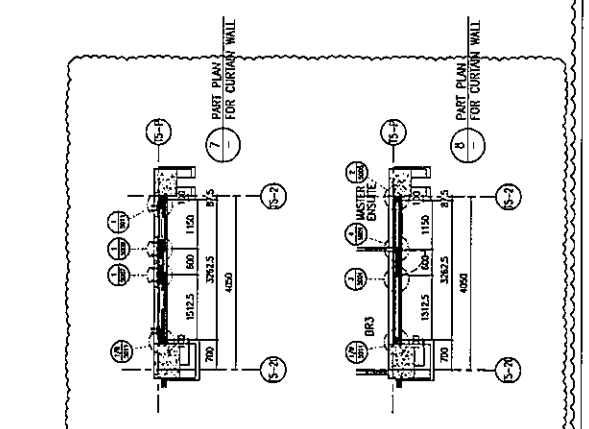
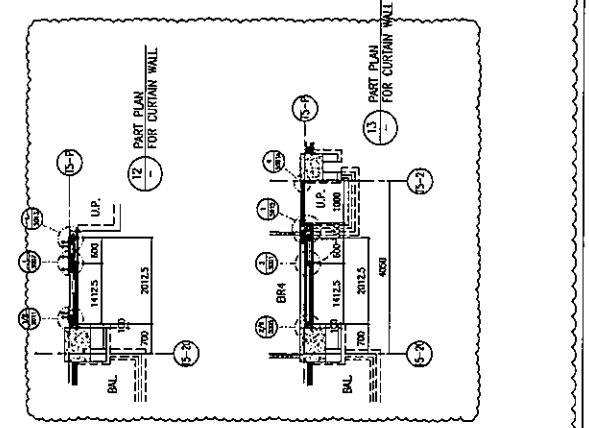

請用A3紙打印

KG-33a/b/c分別對應圖  
 號T5-CW-KG33a/b/c

**SHIMAO GROUP HOLDINGS LIMITED**  
**ARCHITECT**  
 10000 TUNG & PARTNERS LIMITED

**MAIN CONTRACTOR**  
 協興建築有限公司  
 HOP HING CONSTRUCTION CO. LTD.

**STRUCTURAL ENGINEER**  
 C.M. HONG & ASSOCIATES LTD.  
 黃志明建築工程師有限公司

**FAÇADE CONSULTANT**  
**MEINHARDT**

**NOTE:**  
 1. ALL DIMENSIONS ARE IN METRE.  
 2. ALL ELEVATIONS ARE VIEWED FROM OUTSIDE.  
 3. ALL DIMENSIONS TO BE VERIFIED ON SITE BEFORE FOUNDATION.

**LEGEND:**  
 (1) - TOTAL MARK NO.  
 (2) - REFER SHEET NO.  
 (3) - F.F.L. --- FINISHED FLOOR LEVEL  
 (4) - S.F.L. --- STRUCTURAL FLOOR LEVEL  
 (5) - --- REVERSED DENOTE

**FLOOR LEVEL (S.F.L.)**

FLOOR LEVEL	HEIGHT
27/F	228.70
26/F	225.40
25/F	222.10
24/F	218.80
23/F	215.50
22/F	212.20
21/F	208.90
20/F	205.60
19/F	202.30
18/F	199.00
17/F	195.70
16/F	192.40
15/F	189.10
14/F	185.80
13/F	182.50
12/F	179.20
11/F	175.90
10/F	172.60
9/F	169.30
8/F	166.00
7/F	162.70
6/F	159.40
5/F	156.10

**PROJECT:** PROPOSED RESIDENTIAL DEVELOPMENT AT N.K.I.L. 6642 YIN PING ROAD KOWLOON

**TITLE:** PART ELEVATION FOR CURTAIN WALL AT TOWER 5

**DATE:** 31-08-21 **SCALE:** 1:50 (A1)

**DRAWN BY:** LHR **CHECKED BY:**

**MTDI**  
 美特銘實業有限公司  
 11/F, Sunny Industrial Centre, 1/F  
 142,438,231-4, Fax: 6027721666

**DWG NO.:** 053-SD-CW-4503 **REV.:** A

請用A3紙打印

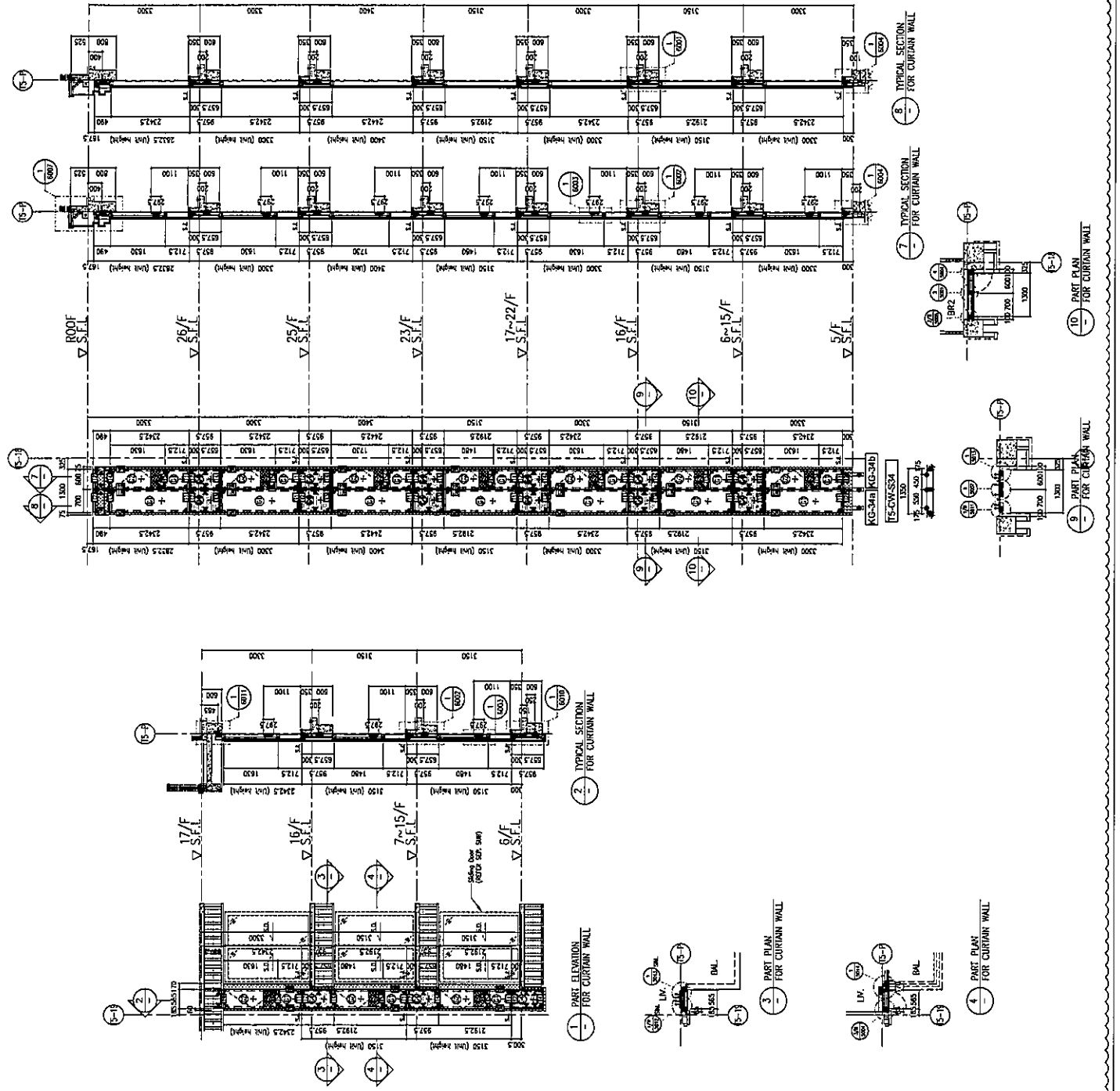

B.D. REF :

請用A3紙打印

**CLIENT :** SHIMAO GROUP HOLDINGS LIMITED  
**ARCHITECT :** YONG PING & PARTNERS LIMITED

**MAIN CONTRACTOR :** 協興建築有限公司  
 HOP HING CONSTRUCTION CO. LTD

**STRUCTURAL ENGINEER :** C.M. HONG & ASSOCIATES LTD  
 黃華明建築工程師有限公司

**PACKAGE CONSULTANT :** MENHARDT

**NOTE :**  
 1. ALL DIMENSIONS ARE IN MM.  
 2. ALL ELEVATIONS ARE VIEWED FROM OUTSIDE.  
 3. ALL DIMENSIONS TO BE VERIFIED ON SITE BEFORE FABRICATION.

**LEGEND :**  
 1. F.F.L. — FINISHED FLOOR LEVEL  
 2. S.F.L. — STRUCTURAL FLOOR LEVEL  
 3. — REVERSED BEING

**REVISIONS :**  
 NO. DATE REVISION SUBJECT TO ARCH. CHANGE

**JOB NO. :** J-853

**PROJECT :** PROPOSED RESIDENTIAL DEVELOPMENT AT N.K.L.L. 6542  
 YIN PING ROAD  
 KOWLOON

**TITLE :** PART ELEVATION FOR CURTAIN WALL AT TOWER 5

**DATE :** 01-APR-21 **SCALE :** 1:80 (A1)

**DRAWN BY :** LHR **CHECKED BY :**

**美特鋁質有限公司**  
 MTDI Aluminium Fabrication Ltd.  
 Units B-3, Sunny Industrial Centre, 1/F  
 142-240/241-1, Tin Shui Industrial Estate  
 TSW: 27277668

**DWG. NO. :** JRS3-SID-CW-4504 **REV. :** A

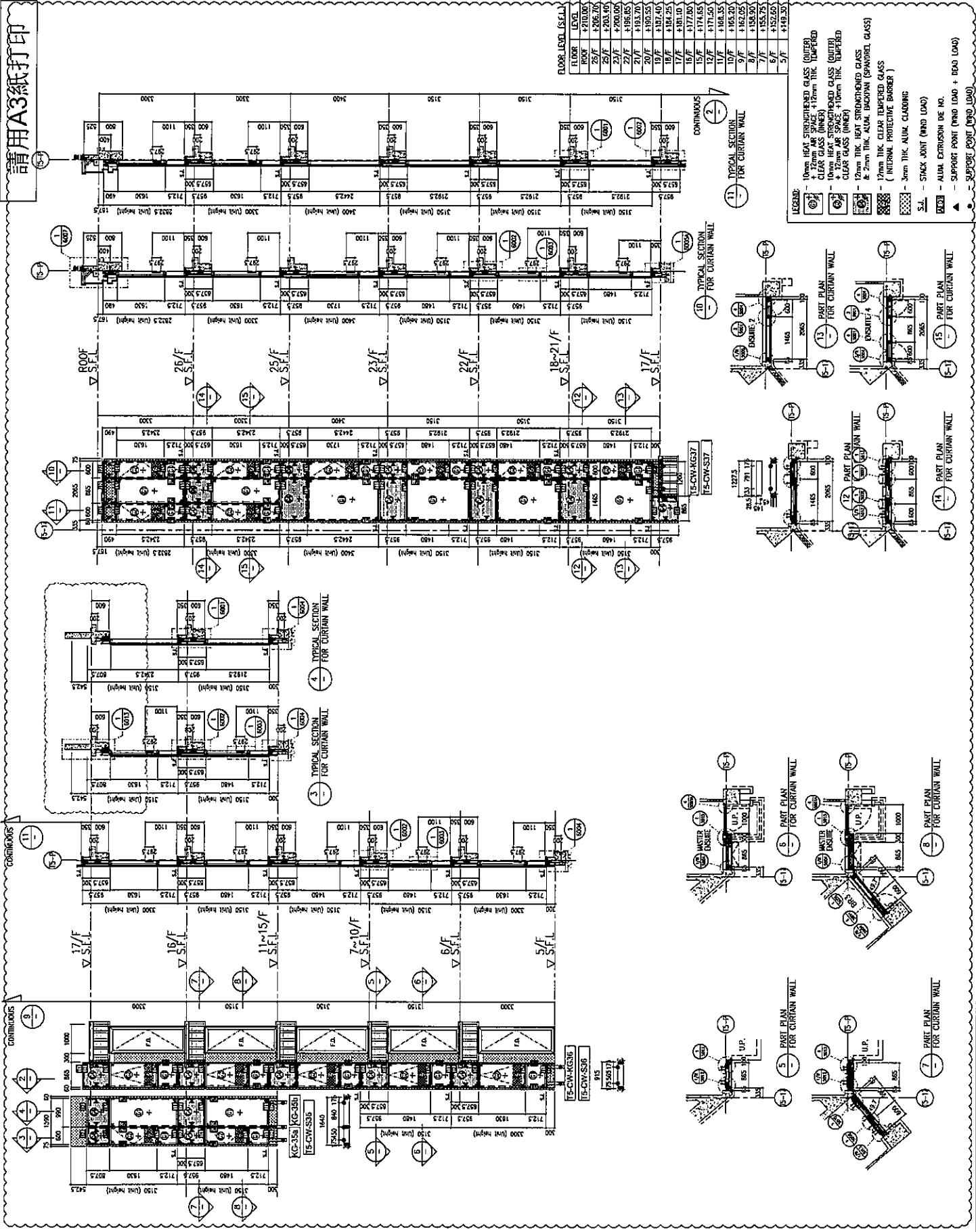

B.D. REF :

請用A3紙打印

**CLIENT :** SHIMAO GROUP HOLDINGS LIMITED

**ARCHITECT :** YONG THING & PARTNERS LIMITED

**TOWN CONTRACTOR :** 協興建築有限公司 SHIP HING CONSTRUCTION CO. LTD

**STRUCTURAL ENGINEER :** C M WONG & ASSOCIATES LTD 黃志偉建築工程師有限公司

**FRAME CONSULTANT :** MEINHARDT

**NOTE :**  
 1. DIMENSIONS ARE IN MM.  
 2. ALL ELEVATIONS ARE VIEWED FROM OUTSIDE.  
 3. ALL DIMENSIONS TO BE VERIFIED ON SITE BEFORE FABRICATION.

**LEGEND :**  
 (A) - ACTUAL MARK NO.  
 (B) - REFER SHEET NO.  
 1. F.F.L. - FINISHED FLOOR LEVEL.  
 2. S.F.L. - STRUCTURAL FLOOR LEVEL.  
 3. (R) - REVERSED INUSE.

**PROJECT :** PROPOSED RESIDENTIAL DEVELOPMENT AT N.K.L.L. 6542 YIN PING ROAD KOWLOON

**PROJECT NO. :** J-853

**DRAWN BY :** LHR

**CHECKED BY :**

**DATE :** 01-APR-21

**SCALE :** 1:60 (A1)

**TITLE :** PART ELEVATION FOR CURTAIN WALL AT TOWER 5

**REV. :** A

**UNITED ENGINEERS & ARCHITECTS LTD.**  
 11/F, Sunny Industrial Centre, 1/F  
 YAC248/211-1 Tel: (852) 2727668

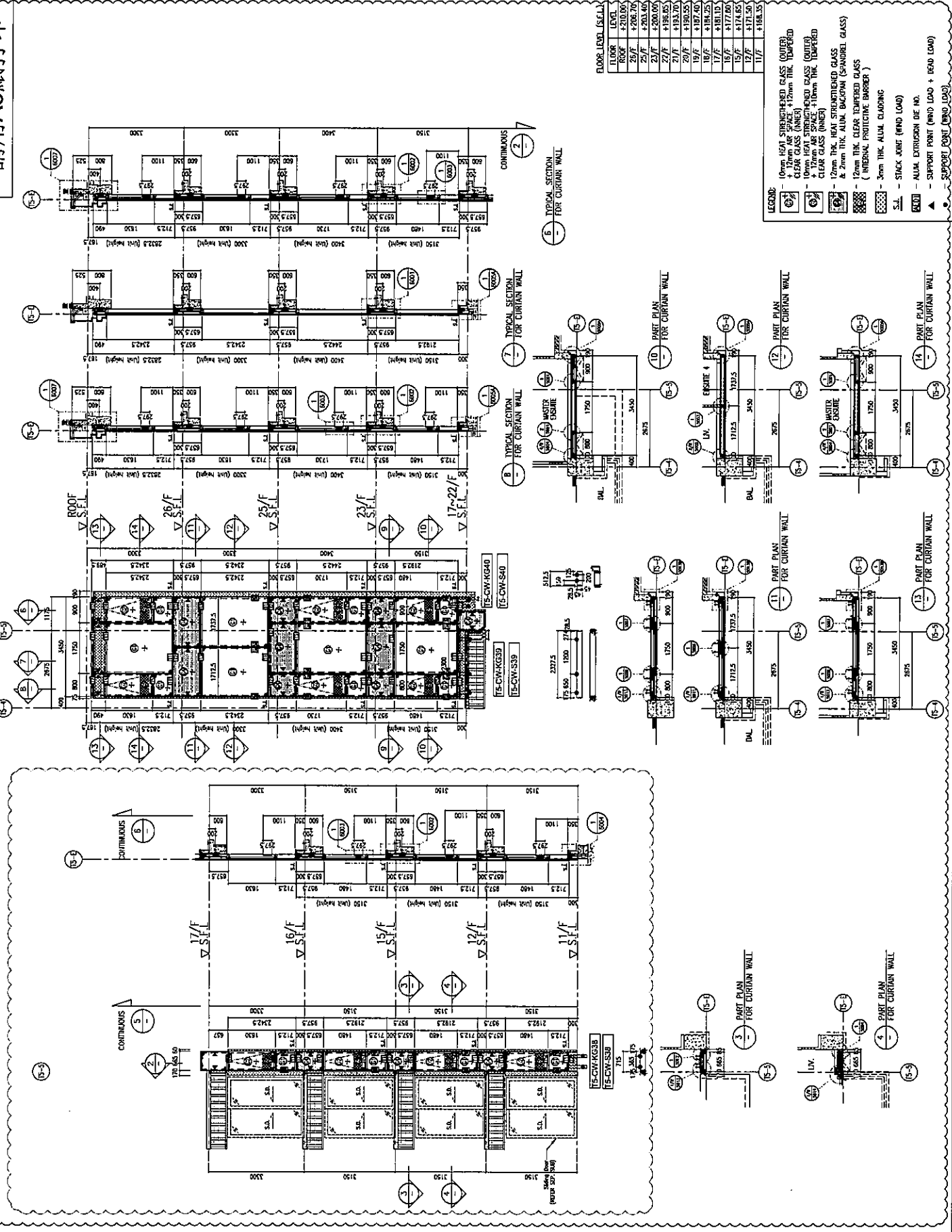

B.O. REF :

請用A3紙打印

**CLIENT :** SHIMAO GROUP HOLDINGS LIMITED

**ARCHITECT :** WONG TUNG & PARTNERS LIMITED

**MAIN CONTRACTOR :** 協興建築有限公司 HYP-HING CONSTRUCTION CO. LTD

**STRUCTURAL ENGINEER :** C H WONG & ASSOCIATES LTD 黃志明建築工程師有限公司

**FAÇADE CONSULTANT :** MEINHARDT

**NOTE :**  
 1. ALL DIMENSIONS ARE IN MM.  
 2. ALL ELEVATIONS ARE VIEWED FROM OUTSIDE.  
 3. ALL DIMENSIONS TO BE VERIFIED ON SITE BEFORE FABRICATION.

**LEGEND :**  
 1. F.F.L. — FINISHED FLOOR LEVEL.  
 2. S.F.L. — STRUCTURAL FLOOR LEVEL.  
 3. — — REVERSED DETAIL.

**REVISIONS :**  
 NO. DATE REVISION SUBJECT BY CHECKED BY

**PROJ. NO. :** J-053

**PROJECT :** PROPOSED RESIDENTIAL DEVELOPMENT AT N.K.L.L. 6542 YIK PING ROAD KOWLOON

**TITLE :** PART ELEVATION FOR CURTAIN WALL AT TOWER 5

**DATE :** 05-APR-21 **SCALE :** 1:60 (A1)

**DRAWN BY :** LHR **CHECKED BY :**

**INC. NO. :** JWB3-SO-CW-4306 **REV. :** A

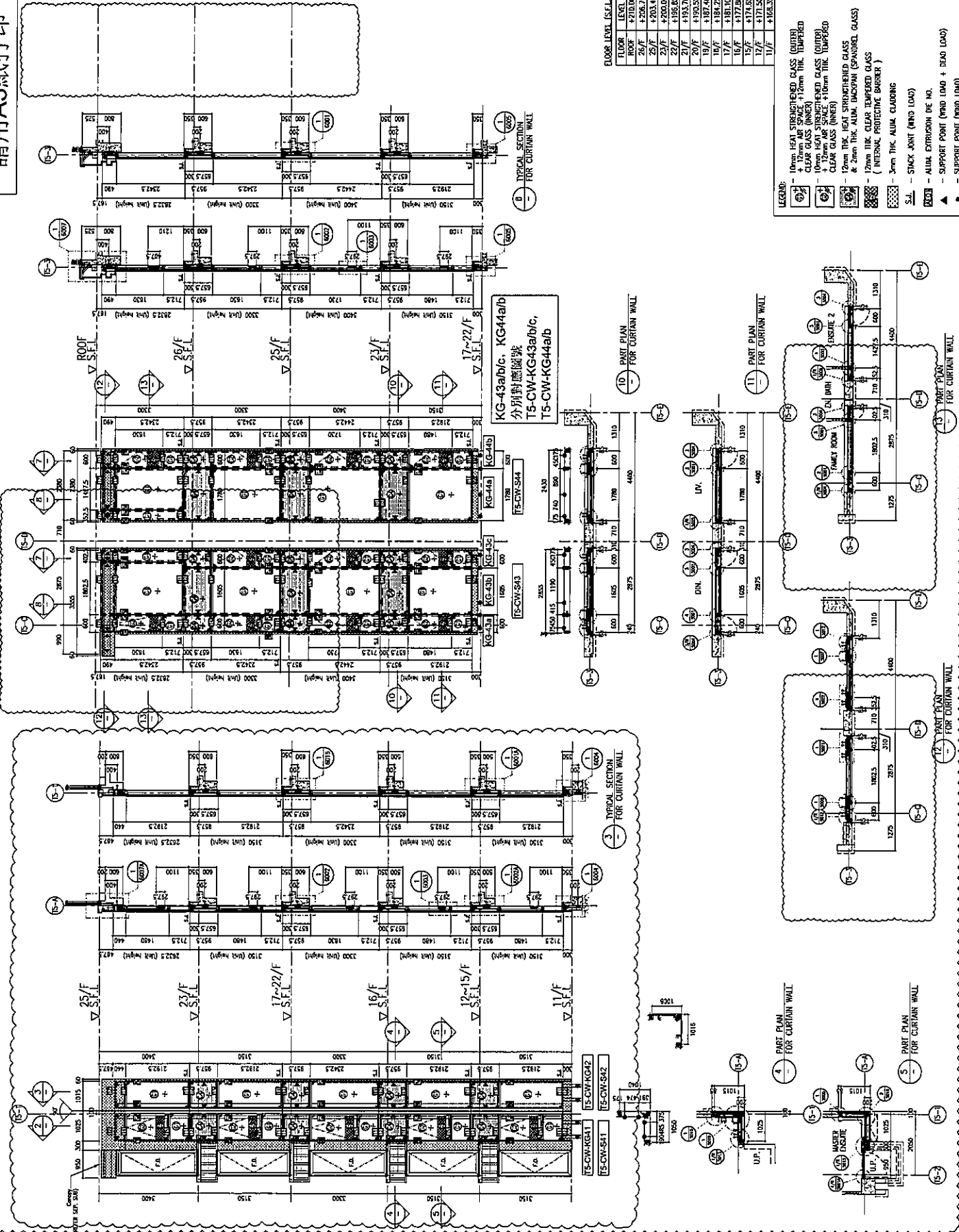

FLOOR LEVEL (S.F.L.)	FINISH LEVEL
10/F	1000
ROOF	+210.00
26/F	+208.00
25/F	+203.00
24/F	+200.00
22/F	+198.05
21/F	+193.00
20/F	+190.00
19/F	+187.40
18/F	+184.25
17/F	+181.10
16/F	+177.80
15/F	+174.50
11/F	+168.35

KG-43a/b/c, KG44a/b  
 分別對應圖號  
 T5-CW-KG43a/b/c,  
 T5-CW-KG44a/b

10mm HEAT STRENGTHENED GLASS (OUTER)  
 + 12mm AIR SPACE + 12mm THK. IMPREG.  
 CLEAR GLASS (INNER)  
 12mm THK. ALUM. IMCOSPAN (SPANDREL GLASS)  
 + 12mm AIR SPACE + 10mm THK. IMPREG.  
 CLEAR GLASS (INNER)  
 12mm THK. HEAT STRENGTHENED GLASS  
 & 2mm THK. ALUM. IMCOSPAN (SPANDREL GLASS)  
 12mm THK. CLEAR TEMPERED GLASS  
 (INTERNAL PROTECTIVE BARRIER)  
 3mm THK. ALUM. CLADDING  
 S.S. — STACK JOINT (WIND LOADING)  
 2025 — ALUM. EXTRUSION (WIND LOADING)  
 ▲ — SUPPORT POINT (WIND LOAD + DEAD LOAD)  
 ● — SUPPORT POINT (WIND LOAD)

B.B. REF :

請用A3紙打印

CLIENT : SHIMAO GROUP HOLDINGS LIMITED

ARCHITECT : YONG TUNG & PARTNERS LIMITED

MAIN CONTRACTOR : 協興建築有限公司 HOP HING CONSTRUCTION CO LTD

STRUCTURAL ENGINEER : CMA CH WONG & ASSOCIATES LTD 黃志明建築工程師有限公司

PACKAGE CONSULTANT : MEINHARDT

NOTE: 1. ALL DIMENSIONS ARE IN METR. 2. ALL ELEVATIONS ARE VIEWED FROM OUTSIDE. 3. ALL DIMENSIONS TO BE VERIFIED ON SITE BEFORE FABRICATION.

LEGEND: 1. ACTUAL MARK NO. 2. F.F.L. --- FINISHED FLOOR LEVEL. 3. S.F.L. --- STRUCTURAL FLOOR LEVEL. 4. --- REVERSED DIM. 5. ---

JOB NO. : J-053 PROJECT : PROPOSED RESIDENTIAL DEVELOPMENT AT N.K.L.L. 6542 YUN PING ROAD KOWLOON

TITLE : PART ELEVATION FOR CURTAIN WALL AT TOWER 5

DATE : 05-APR-21 SCALE : 1:50 (A1) DRAWN BY : LHR CHECKED BY :

美特鋸實有限公司 MIDJI ALUMINIUM FABRICATOR LTD. Unit 6-8, Sunny Industrial Center, 1/F 100, Yue Yue Jang Road, Kowloon, HONG KONG Tel: (852) 27276666 Fax: (852) 27276666

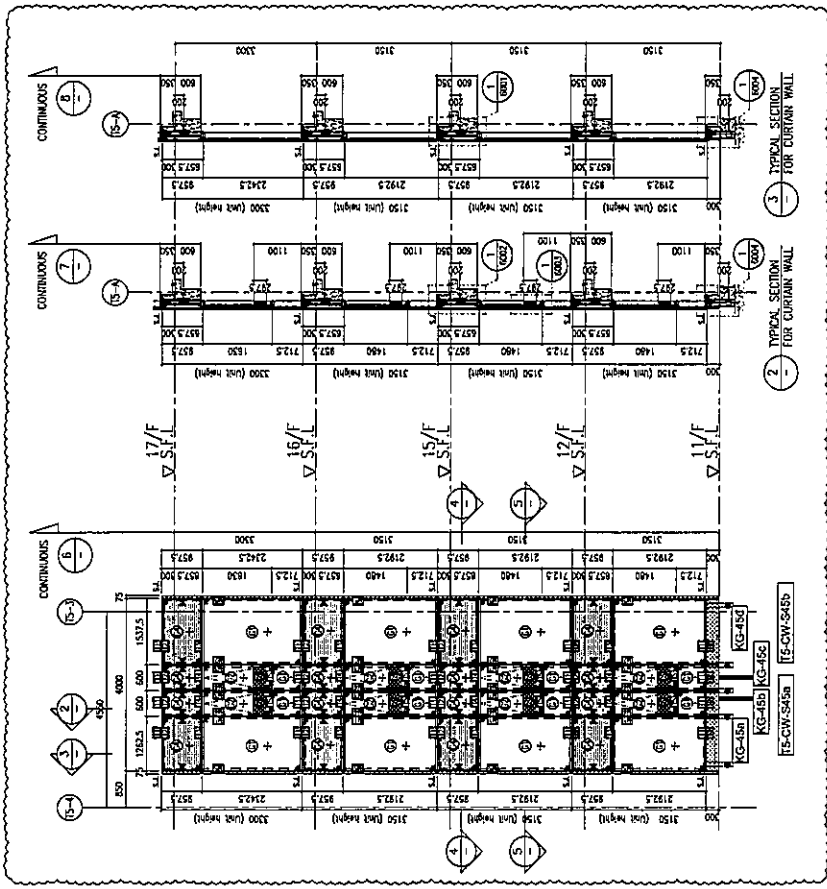
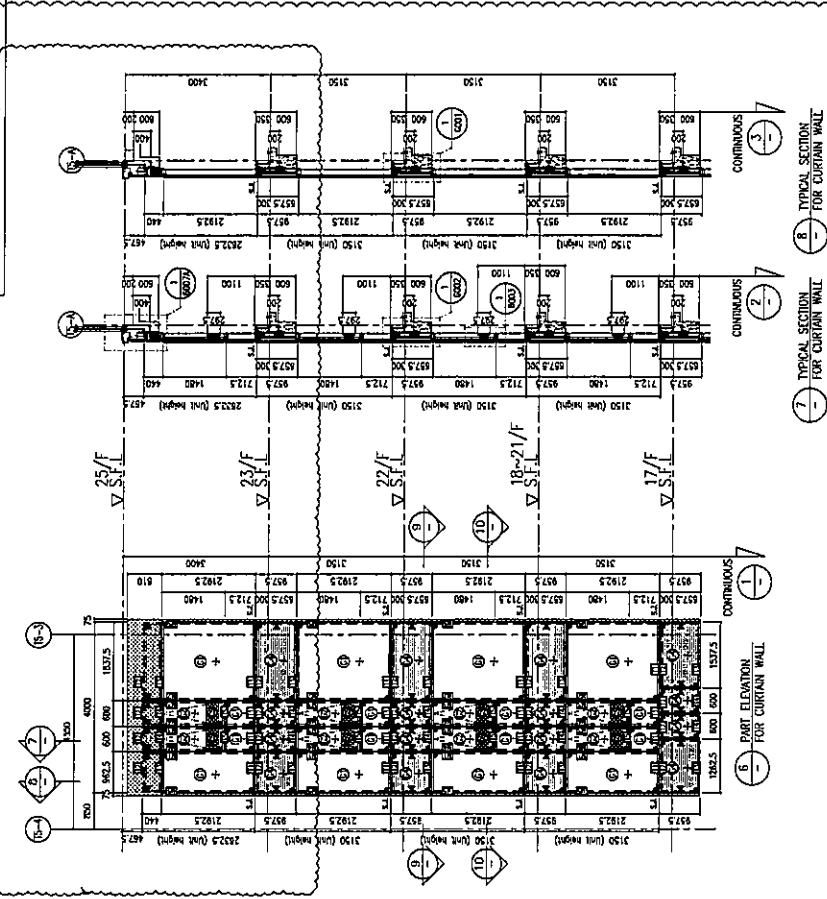

KG-45a/b/c/d 對 應 圖 號 T5-CW-KG45a/b/c/d

KG-45a KG-45b KG-45c KG-45d

IS-CW-S45a IS-CW-S45b

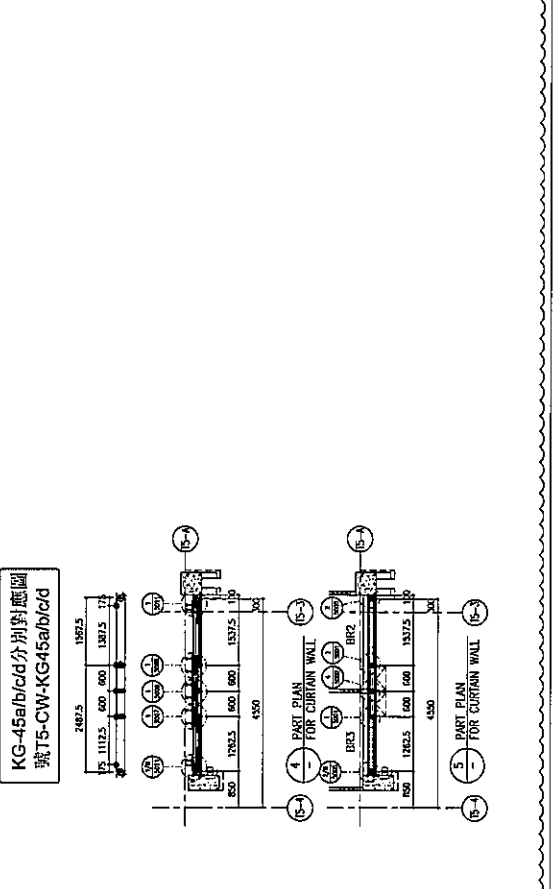
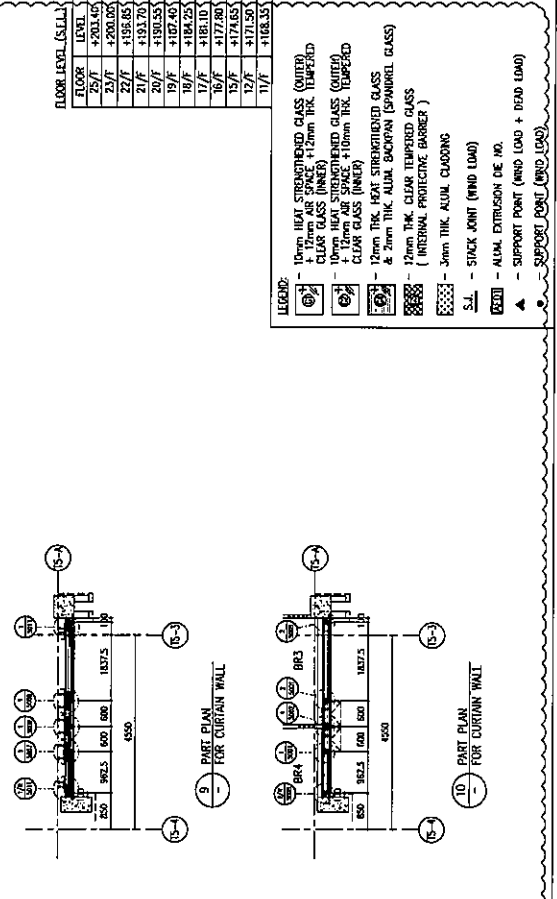

FLOOR LEVEL (S.F.L.) table with columns for floor level and height.

- LEGEND: 1. 10mm HEAT STRENGTHENED GLASS (OUTER) + 12mm AIR SPACE + 12mm THK. TEMPERED CLEAR GLASS (INNER) ... 2. 12mm HEAT STRENGTHENED GLASS (OUTER) + 12mm AIR SPACE + 10mm THK. TEMPERED CLEAR GLASS (INNER) ... 3. 12mm THK. HEAT STRENGTHENED GLASS & 2mm THK. ALUM. BACKPAN (SPANDREL GLASS) (INTERNAL PROTECTIVE BARRIER) ... 4. 3mm THK. ALUM. CLADDING ... 5. ALUM. EXTRUSION OF NO. ... 6. SUPPORT POINT (WIND LOAD + DEAD LOAD) ... 7. SUPPORT POINT (WIND LOAD)

SPL. REF. :

請用A3紙打印

**SHIMAO GROUP HOLDINGS LIMITED**  
 協興集團有限公司  
**協興建築有限公司**  
 HOP HING CONSTRUCTION CO. LTD

**STRUCTURAL ENGINEER :**  
**CMA CHONG & ASSOCIATES LTD**  
 黃志偉建築工程師有限公司

**PACKAGE CONSULTANT :**  
**MEINHARDT**

**NOTE:**  
 1. ALL DIMENSIONS ARE IN MM.  
 2. ALL DIMENSIONS ARE VIEWED FROM OUTSIDE.  
 3. ALL DIMENSIONS TO BE VERIFIED ON SITE BEFORE FOUNDATION.

**LEGEND:**  
 (1) ACTUAL WORK NO.  
 (2) REFER SHEET NO.  
 1. F.F.L. - FINISHED FLOOR LEVEL.  
 2. S.F.L. - STRUCTURAL FLOOR LEVEL.  
 3. - - - REVERSED DIMEN.

NO.	REV.	REVISION SUBJECT TO WORK COMMENT	DATE	PREPARED	BY
1					

**JOB NO. :** J-653  
**PROJECT :** PROPOSED RESIDENTIAL DEVELOPMENT AT N.K.I.L. 6542 YIN PING ROAD KOWLOON

**TITLE :** PART ELEVATION FOR CURTAIN WALL AT TOWER 5

**DATE :** 05-APR-21 **SCALE :** 1:60 (A1)  
**DRAWN BY :** LHR **CHECKED BY :**  
**MEINHARDT CONSULTANTS LTD.**  
 4/F, 1/F, Sunny Industrial Centre, 1/F  
 410, Queen's Road East, HONG KONG  
 Tel: (852) 27727666 Fax: (852) 2772666

**DWG. NO. :** J653-SD-CN-4506 **REV. :** A

**MEINHARDT CONSULTANTS LTD.**  
 4/F, 1/F, Sunny Industrial Centre, 1/F  
 410, Queen's Road East, HONG KONG  
 Tel: (852) 27727666 Fax: (852) 2772666

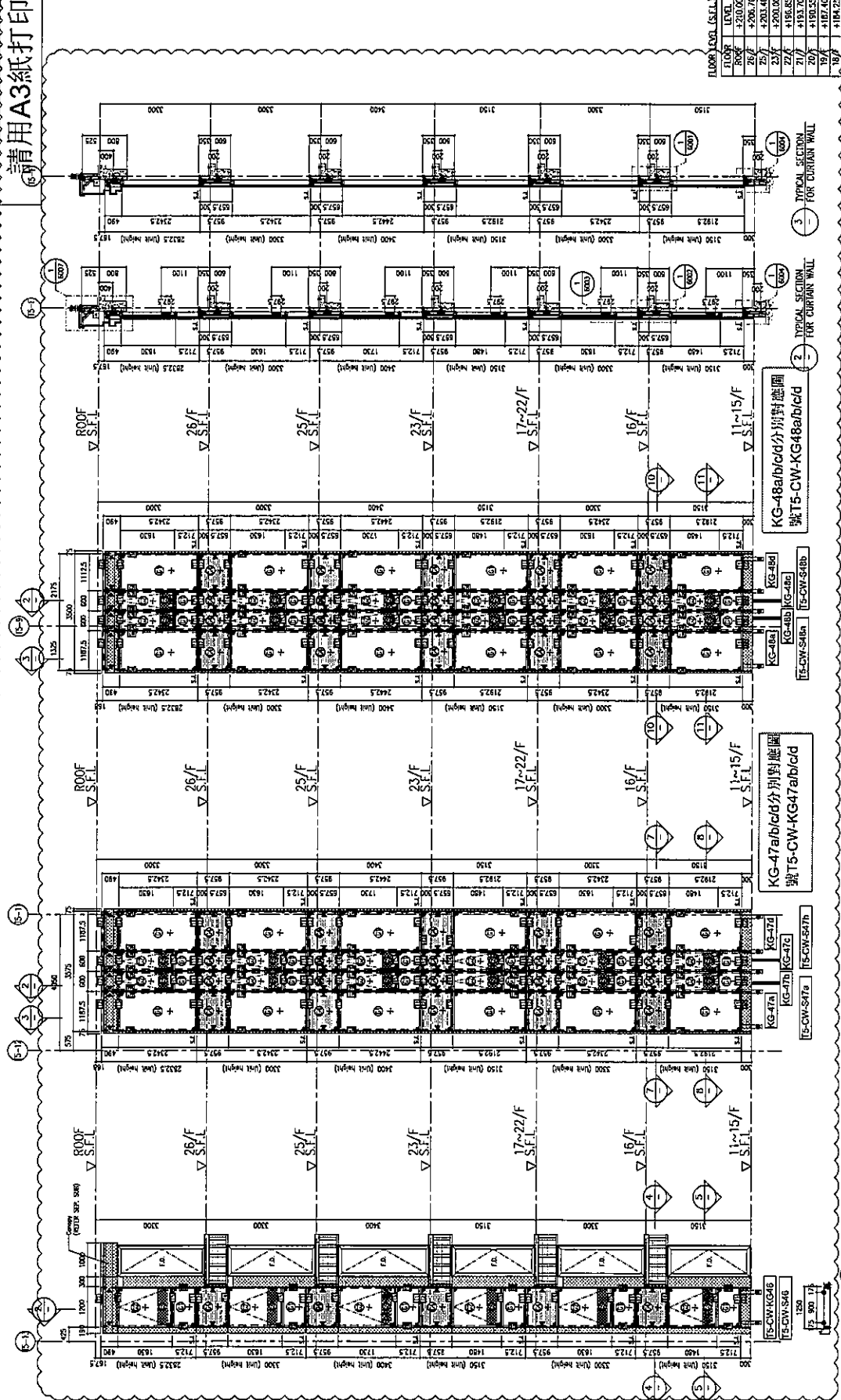

**FLOOR LEVEL (S.F.L.)**

FLOOR	11~15/F	1187.5
ROOF	220.00	1187.5
26/F	220.00	1187.5
25/F	220.00	1187.5
23/F	220.00	1187.5
22/F	220.00	1187.5
21/F	220.00	1187.5
20/F	220.00	1187.5
19/F	220.00	1187.5
18/F	220.00	1187.5
17/F	220.00	1187.5
16/F	220.00	1187.5
15/F	220.00	1187.5
12/F	220.00	1187.5
11/F	220.00	1187.5

**LEGEND:**

- 10mm HEAT STRENGTHENED GLASS (OUTER) + 12mm AIR SPACE + 12mm THK. TEMPERED GLASS (INNER)
- 10mm HEAT STRENGTHENED GLASS (OUTER) + 12mm AIR SPACE + 10mm THK. TEMPERED CLEAR GLASS (INNER)
- 12mm THK. HEAT STRENGTHENED GLASS & 2mm THK. ALUM. BACKPAK (SPANDREL GLASS)
- 12mm THK. CLEAR TEMPERED GLASS (INTERNAL PROTECTIVE BARRIER)
- 3mm THK. ALUM. CLADDING
- S.L. - STACK JOINT (WIND LOAD)
- ▲ - ALUM. EXTRUSION DE. HO.
- ▲ - SUPPORT POINT (WIND LOAD + 800 LOAD)
- ▲ - SUPPORT POINT (WIND LOAD)

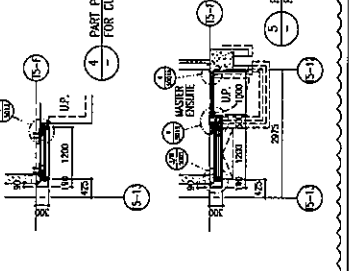
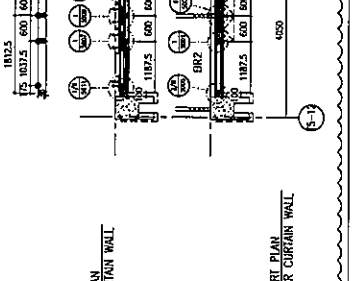
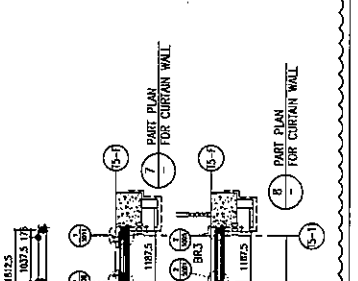
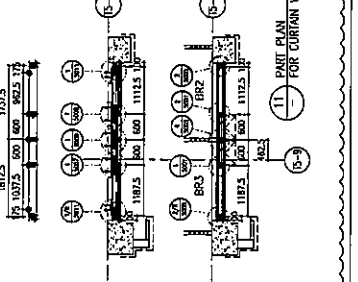

D.D. REF :

請用A3紙打印

CLIENT : SHIMAO GROUP HOLDINGS LIMITED

ARCHITECT : WOONG TUNG & PARTNERS LIMITED

MAIN CONTRACTOR : 協興建築有限公司 HP HING CONSTRUCTION CO LTD

STRUCTURAL ENGINEER : C.M. WONG & ASSOCIATES LTD 黃志明建築工程師有限公司

FRAME CONSULTANT : MEIN-HARDT

NOTE:

1. ALL DIMENSIONS ARE IN MM.
2. ALL ELEVATIONS ARE VIEWED FROM OUTSIDE.
3. ALL DIMENSIONS TO BE VERIFIED ON SITE BEFORE FABRICATION.

LEGEND:

① - DENIAL MARK NO.

② - REFER SHEET NO.

1. F.F.L. -- FINISHED FLOOR LEVEL

2. S.F.L. -- STRUCTURAL FLOOR LEVEL

3. Ⓜ -- REVERSED MARK

JOB NO. : J-853

PROJECT : PROPOSED RESIDENTIAL DEVELOPMENT AT N.K.L.L. 6542 YIN PING ROAD KOWLOON

TITLE : PART ELEVATION FOR CURTAIN WALL AT TOWER 5

DATE : 06-OCT-21 SCALE : 1:60 (A1)

DRAWN BY : LHR CHECKED BY :

MEIN-HARDT  
MIDI  
MIDI (ARCHITECTURE & ENGINEERING) LTD.  
Unit E-1, Sunny Industrial Centre, 1/F  
182,408,871-1, Tel: (852) 2772686  
Fax: (852) 2772685

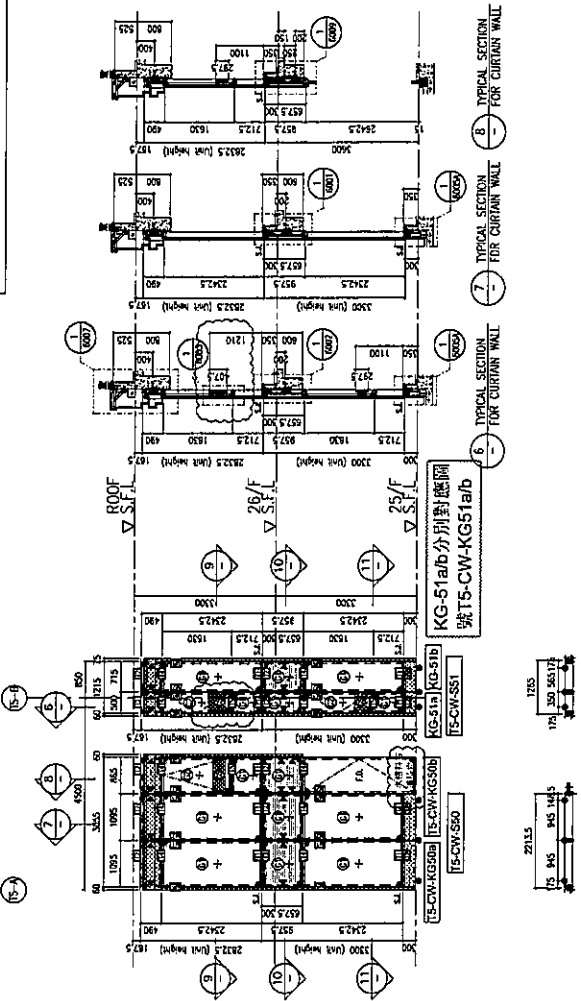

LEGEND:

- ① - 12mm HEAT STRENGTHENED GLASS (OUTER)
- ② - 12mm AIR SPACE
- ③ - 12mm HEAT STRENGTHENED GLASS (INNER)
- ④ - 12mm AIR SPACE
- ⑤ - 12mm HEAT STRENGTHENED GLASS (OUTER)
- ⑥ - 12mm AIR SPACE
- ⑦ - 12mm HEAT STRENGTHENED GLASS (INNER)
- ⑧ - 2mm THK. HEAT TEMPERED GLASS (SPANDREL GLASS)
- ⑨ - 2mm THK. ALUM. BACKSPAN (SPANDREL GLASS)
- ⑩ - 12mm THK. CLEAR TEMPERED GLASS (INTERNAL PROTECTIVE PLY)
- ⑪ - 3mm THK. ALUM. CLADDING

S.L. - STICK JOINT (WIND LOAD)

EXT. - ALUM. EXTENSION (WIND LOAD)

▲ - SUPPORT POINT (WIND LOAD + DEAD LOAD)

● - SUPPORT POINT (WIND LOAD)

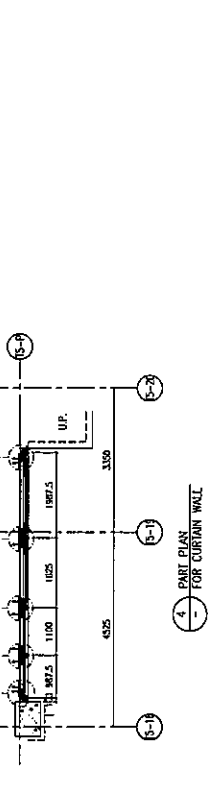
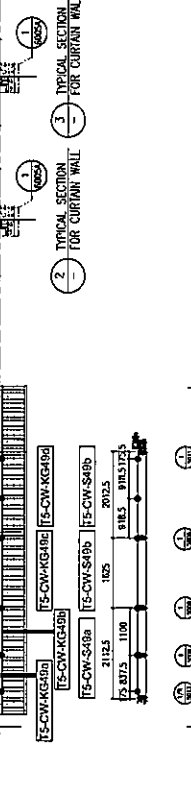
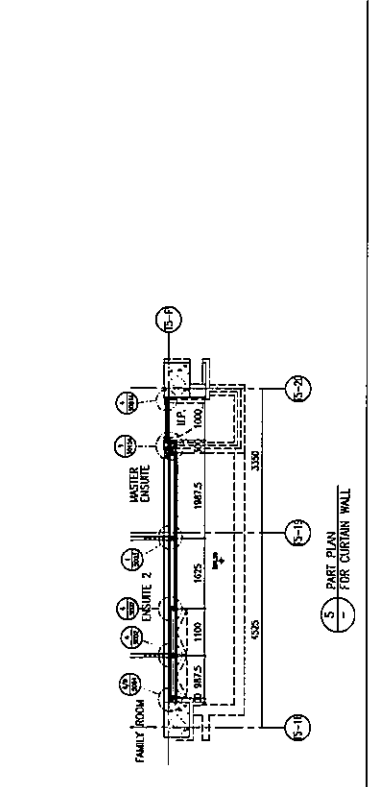
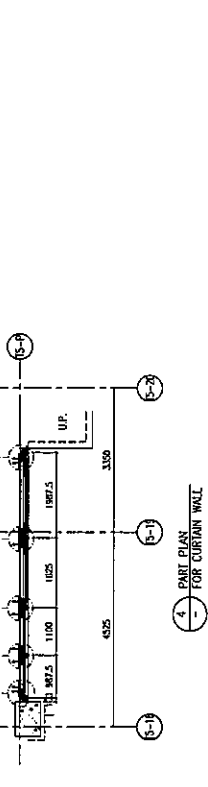
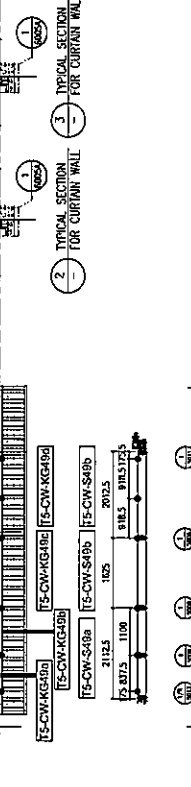
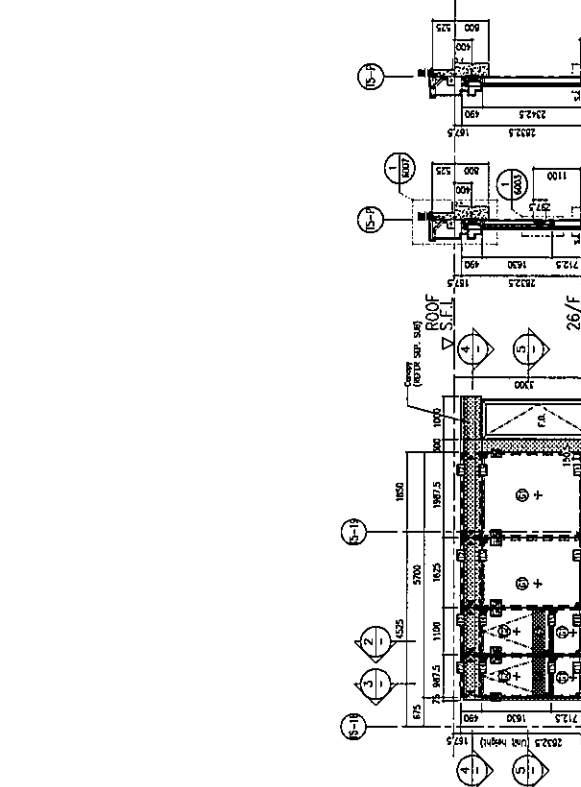

LEGEND:

- ① - 12mm HEAT STRENGTHENED GLASS (OUTER)
- ② - 12mm AIR SPACE
- ③ - 12mm HEAT STRENGTHENED GLASS (INNER)
- ④ - 12mm AIR SPACE
- ⑤ - 12mm HEAT STRENGTHENED GLASS (OUTER)
- ⑥ - 12mm AIR SPACE
- ⑦ - 12mm HEAT STRENGTHENED GLASS (INNER)
- ⑧ - 2mm THK. HEAT TEMPERED GLASS (SPANDREL GLASS)
- ⑨ - 2mm THK. ALUM. BACKSPAN (SPANDREL GLASS)
- ⑩ - 12mm THK. CLEAR TEMPERED GLASS (INTERNAL PROTECTIVE PLY)
- ⑪ - 3mm THK. ALUM. CLADDING

S.L. - STICK JOINT (WIND LOAD)

EXT. - ALUM. EXTENSION (WIND LOAD)

▲ - SUPPORT POINT (WIND LOAD + DEAD LOAD)

● - SUPPORT POINT (WIND LOAD)

請用A3紙打印

B.D. REF :

<b>SHIMAD GROUP HOLDINGS LIMITED</b> WONG TUNG & PARTNERS LIMITED 	
<b>協興建築有限公司</b> HOP HING CONSTRUCTION CO. LTD	
<b>STRUCTURAL ENGINEER :</b> C.M. WONG & ASSOCIATES LTD 黃志明建築工程師有限公司	
<b>PROJECT CONSULTANT :</b> 	
<b>NOTE :</b> 1. ALL DIMENSIONS ARE IN MM. 2. ALL ELEVATIONS ARE VIEWED FROM OUTSIDE. 3. ALL DIMENSIONS TO BE VERIFIED ON SITE BEFORE FABRICATION.	
<b>LEGEND :</b> (S1) - REIN. MARK NO. (S2) - REIN. SHEET NO. 1. F.F.L. -- FINISHED FLOOR LEVEL 2. S.F.L. -- STRUCTURAL FLOOR LEVEL 3. (R) -- REVERSED DETAIL	
<b>DATE :</b> J-853 <b>APP. NO. :</b> J-853 <b>PROJECT :</b> PROPOSED RESIDENTIAL DEVELOPMENT AT N.K.L.L. 0542 YIN PING ROAD KOWLOON	<b>TITLE :</b> PART ELEVATION FOR CURTAIN WALL AT TOWER 5
<b>DATE :</b> 06-OCT-21 <b>SCALE :</b> 1:80 (A1)	<b>FORMED BY :</b> LHR <b>CHECKED BY :</b>
<b>美特銘實有限公司</b> MIDI ASSOCIATE ENGINEERS LTD. 2/F, 8-B, Sunny Industrial Centre, 1/F 142-240B211-2, Tsim Sha Tsui, KOWLOON HWP NO. : J853-50-CW-451D REV. : A	

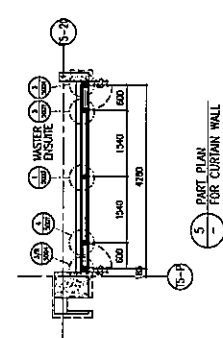
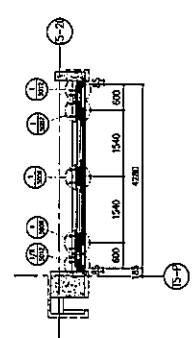
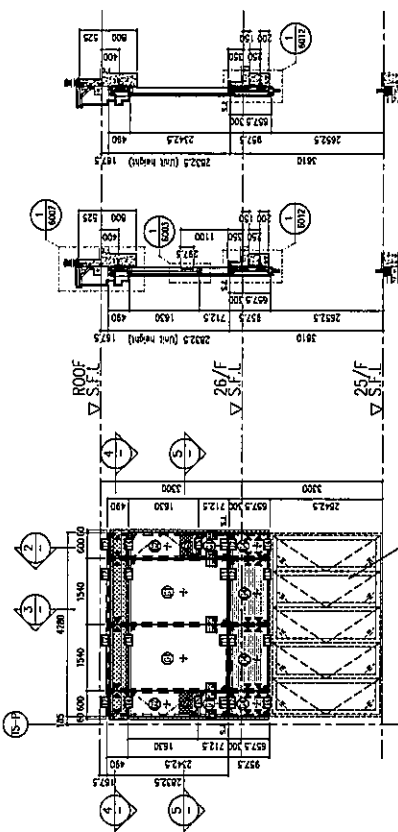

FLOOR LEVEL (S.F.L.)	FLOOR	LEVEL
	ROOF	+270.00
	26/F	+266.70
	25/F	+263.40

- LEGEND:**
- 10mm HEAT STRENGTHENED GLASS (OUTER) + 12mm AIR SPACE + 12mm THK. TEMPERED CLEAR GLASS (INNER)
  - 10mm HEAT STRENGTHENED GLASS (OUTER) + 12mm AIR SPACE + 10mm THK. TEMPERED CLEAR GLASS (INNER)
  - 12mm THK. HEAT STRENGTHENED GLASS & 2mm THK. ALUM. BACKSPAN (SPANDREL GLASS)
  - 12mm THK. CLEAR TEMPERED GLASS (INTERNAL PROTECTIVE BARRIER)
  - 3mm THK. ALUM. CLADDING
  - S.L. - STACK JOINT (WIND LOAD)
  - ALUM. EXTENSION DIE IN.
  - SUPPORT POINT (WIND LOAD + DEAD LOAD)
  - SUPPORT POINT (WIND LOAD)