



工程指示 / 要求簡箋 ENGINEER INSTRUCTIONS (E.I.)

| | | | |
|---------|--|-------|-----------|
| 工程指示編號: | EI- 8107 | 修改版本: | - |
| | HK- 1409 | | |
| 工程編號: | J 853 | 工程名稱: | 延坪道 (第2期) |
| 收件人: | 生統/ | 發件人: | Jingo |
| 工程項目: | Feature wall 飾線 鋁板加工圖地盤用 修改 part 5 | 日期: | 1/8/2024 |

| | | |
|---------------------------------|--|------------------------------------|
| <input type="checkbox"/> 原合約工程包 | <input type="checkbox"/> 原合約工程加 / 減脹 QT- | <input type="checkbox"/> 新工程報價 QT- |
|---------------------------------|--|------------------------------------|

| | |
|----------------|-----------|
| 信件批核號碼/圖紙參考編號: | 批核模具圖紙編號: |
| 客戶指示附件: | 管理內部批簽署: |

| | | |
|------------------------------------|-------------------------------------|-------------------------------|
| <input type="checkbox"/> 初步鋁料 B.M. | <input type="checkbox"/> 加工拆圖, 然後生產 | <input type="checkbox"/> 尺寸表 |
| <input type="checkbox"/> 正式鋁料 B.M. | <input type="checkbox"/> 技術上資料/指示 | <input type="checkbox"/> 報價 |
| <input type="checkbox"/> 配件 B.M. | <input type="checkbox"/> 樣辦或貨品說明書 | <input type="checkbox"/> 分判合約 |
| <input type="checkbox"/> 其他: | | |

內容: 按修改圖紙加工

按孤位圖包裝

完成上列要求日期 1/2/8/2024

國內

| | | | | | |
|---------------------------------|------------------------------|---|---|--------------------------------|------------------------------|
| <input type="checkbox"/> 生產技術總監 | <input type="checkbox"/> 連附件 | <input type="checkbox"/> 技術部 | <input type="checkbox"/> 連附件 | <input type="checkbox"/> 生產部 | <input type="checkbox"/> 連附件 |
| <input type="checkbox"/> 採購部 | <input type="checkbox"/> 連附件 | <input checked="" type="checkbox"/> 生產統籌部 | <input checked="" type="checkbox"/> 連附件 | <input type="checkbox"/> 報關組 | <input type="checkbox"/> 連附件 |
| <input type="checkbox"/> 質檢部 | <input type="checkbox"/> 連附件 | <input type="checkbox"/> 會計部 | <input type="checkbox"/> 連附件 | <input type="checkbox"/> 機械設計部 | <input type="checkbox"/> 連附件 |
| <input type="checkbox"/> 香港辦 | <input type="checkbox"/> 連附件 | <input type="checkbox"/> 其他: | | | |

香港

| | | | | | | | |
|------------------------------|------------------------------|------------------------------|------------------------------|--|---|------------------------------|------------------------------|
| <input type="checkbox"/> 行政部 | <input type="checkbox"/> 連附件 | <input type="checkbox"/> 會計部 | <input type="checkbox"/> 連附件 | <input type="checkbox"/> 統籌部 | <input type="checkbox"/> 連附件 | <input type="checkbox"/> 工程部 | <input type="checkbox"/> 連附件 |
| <input type="checkbox"/> 採購部 | <input type="checkbox"/> 連附件 | <input type="checkbox"/> QS部 | <input type="checkbox"/> 連附件 | <input checked="" type="checkbox"/> 地盤管理 | <input checked="" type="checkbox"/> 連附件 | <input type="checkbox"/> 維修部 | <input type="checkbox"/> 連附件 |

| | |
|---------|------------|
| *發件人簽署: | *組別成員批核簽署: |
| 傳遞編號: | 項目經理簽署: |

| | | | | | | | | | | | | | | | | | | | | | | | | | |
|---------|--------------------|---|--------|--------|--------|--------|----------|--------|--------|--------|------|-----------|-------------------|---------|---------|------|--|--------|--|--------------------------|--|-----------|--|------|--|
| PROJECT | | YIN PING ROAD KOWLOON FEATURE WALL (PHASE 2) | | | | | MATERIAL | | 3mm鋁板 | | | | | COATING | | PVF2 | | COLOUR | | EC-DG-D334232-ZD1(SS-01) | | MARK. NO. | | QTY. | |
| REV. | CHECKED DATE BY | PART NUMBER | Dim. A | Dim. B | Dim. C | Dim. D | Dim. E | Dim. F | Dim. G | Dim. H | QTY. | Inv. Code | ASSEMBLE ON PARTS | | 注：用于B区域 | | | | | | | | | | |
| - | | FW-1101 | - | - | - | - | - | - | - | - | 2 | | | | | | | | | | | | | | |

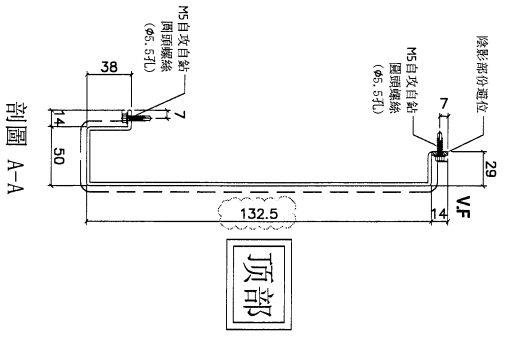
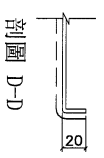
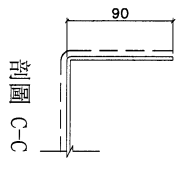
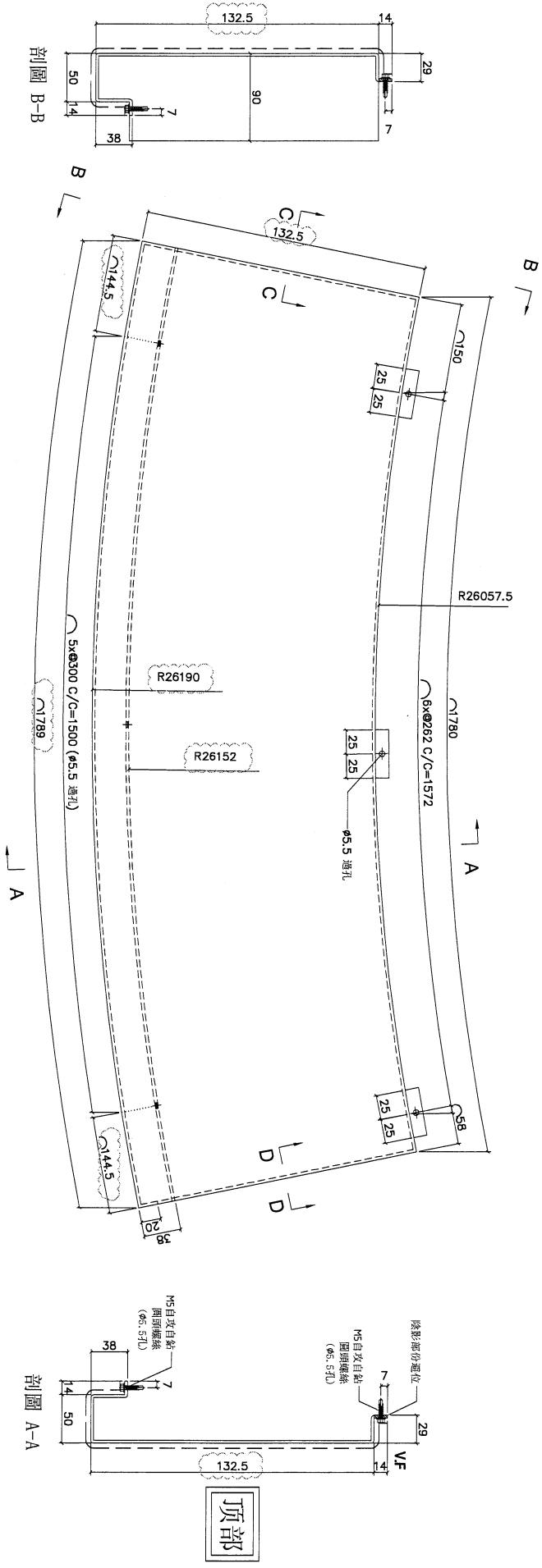

地盤用
用A3紙打印

| | | | | | | | | | | | |
|----------|---------|------|---|-------|---|------|------------|----------|--|-------------|--|
| DWG. NO. | FW-1101 | REV. | A | SCALE | - | DATE | 06-07-2024 | DRAWN BY | | APPROVED BY | |
|----------|---------|------|---|-------|---|------|------------|----------|--|-------------|--|

| | | | | | | | | | | | | | | | | | | | | | | | | | | | | | | | | | | | | | | | |
|-------------------------|--|-------------|--|---|--|--------|--|----------|--|--------|--|--------|--|--------|--|---------|--|--------|--|------|--|-----------|--|-------------------|--|--|--|--------------------------|--|--|--|-----------|--|--|--|------|--|--|--|
| PROJECT | | | | YIN PING ROAD KOWLOON FEATURE WALL (PHASE 2) | | | | MATERIAL | | | | 3mm铝板 | | | | COATING | | | | PVF2 | | | | COLOUR | | | | EC-DG-D334232-ZD1(SS-01) | | | | MARK. NO. | | | | QTY. | | | |
| REV. / CHANGED BY | | PART NUMBER | | Dim. A | | Dim. B | | Dim. C | | Dim. D | | Dim. E | | Dim. F | | Dim. G | | Dim. H | | QTY. | | Inv. Code | | ASSEMBLE ON PARTS | | | | 地盤用 | | | | | | | | | | | |
| - | | FW-T102 | | - | | - | | - | | - | | - | | - | | - | | - | | 4 | | | | 注：用于B区域 | | | | 用A3紙打印 | | | | | | | | | | | |

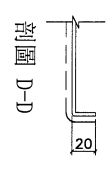
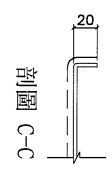
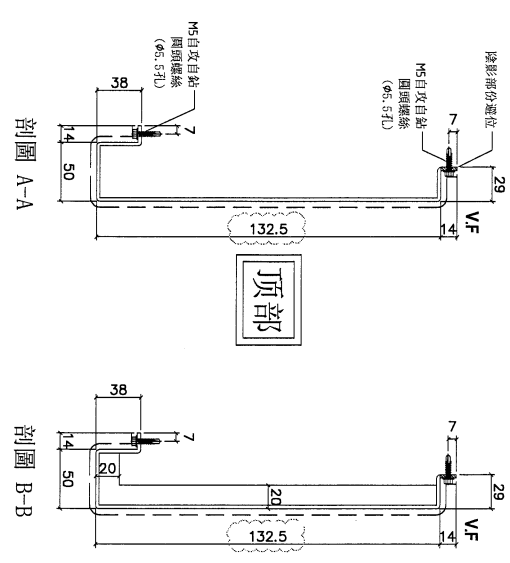
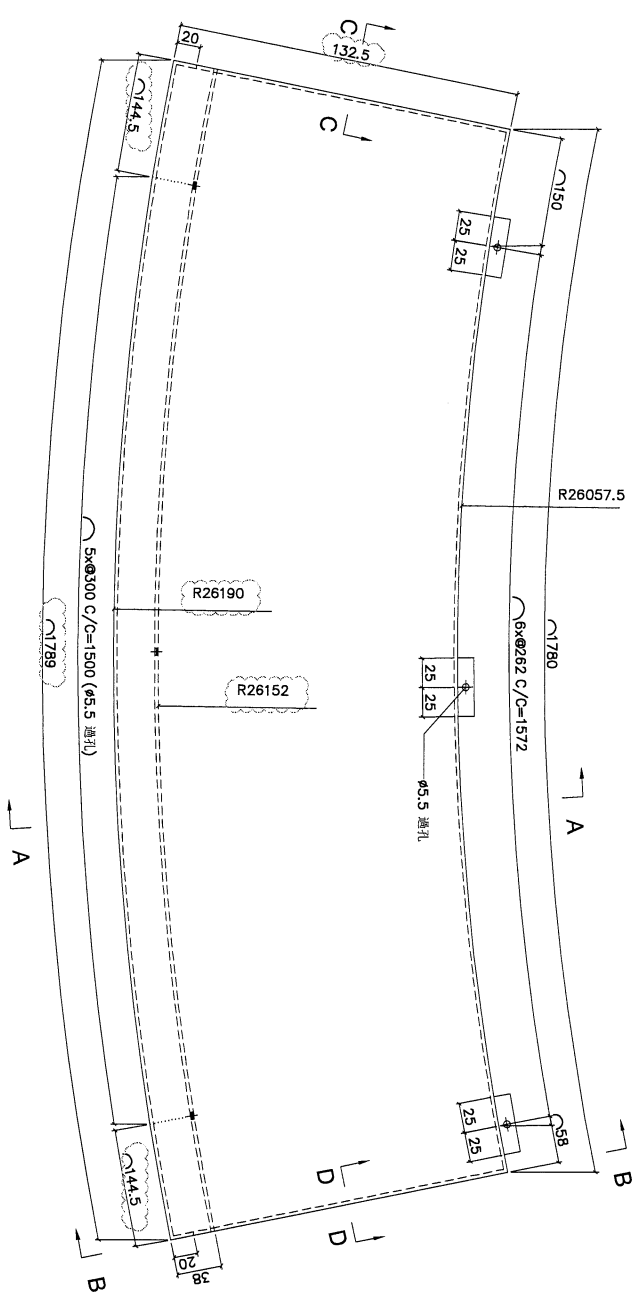

| | | | | | | | | | | | | | | | | | |
|----------|--|---------|--|------|--|---|--|-------|--|------|--|------------|--|----------|--|-------------|--|
| DWG. NO. | | FW-T102 | | REV. | | A | | SCALE | | DATE | | 06-07-2024 | | DRAWN BY | | APPROVED BY | |
|----------|--|---------|--|------|--|---|--|-------|--|------|--|------------|--|----------|--|-------------|--|

PROJECT
YIN PING ROAD KOWLOON
FEATURE WALL (PHASE 2)

MATERIAL
3mm铝板

COATING
PVF2

COLOUR
EC-DG-D334232-ZD1(SS-01)

MARK. NO.

QTY.

| CHKD BY | PART NUMBER | Dim. A | Dim. B | Dim. C | Dim. D | Dim. E | Dim. F | Dim. G | Dim. H | QTY. | Inv. Code | ASSEMBLE ON PARTS |
|---------|-------------|--------|--------|--------|--------|--------|--------|--------|--------|------|-----------|-------------------|
| FW-T104 | | | | | | | | | | 9 | | ASSEMBLE ON PARTS |

地盤用

用A3紙打印

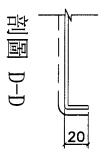
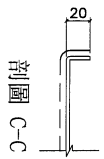
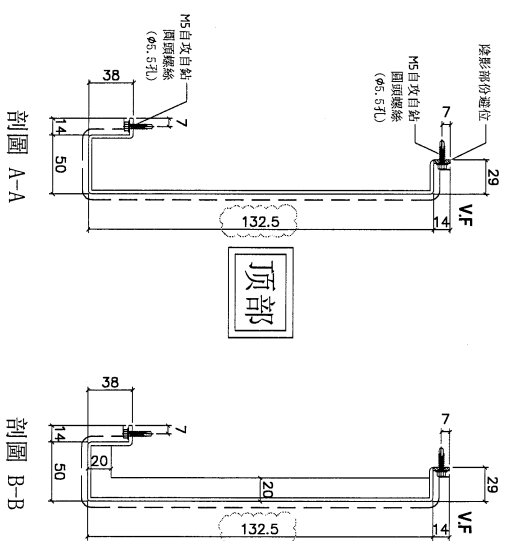
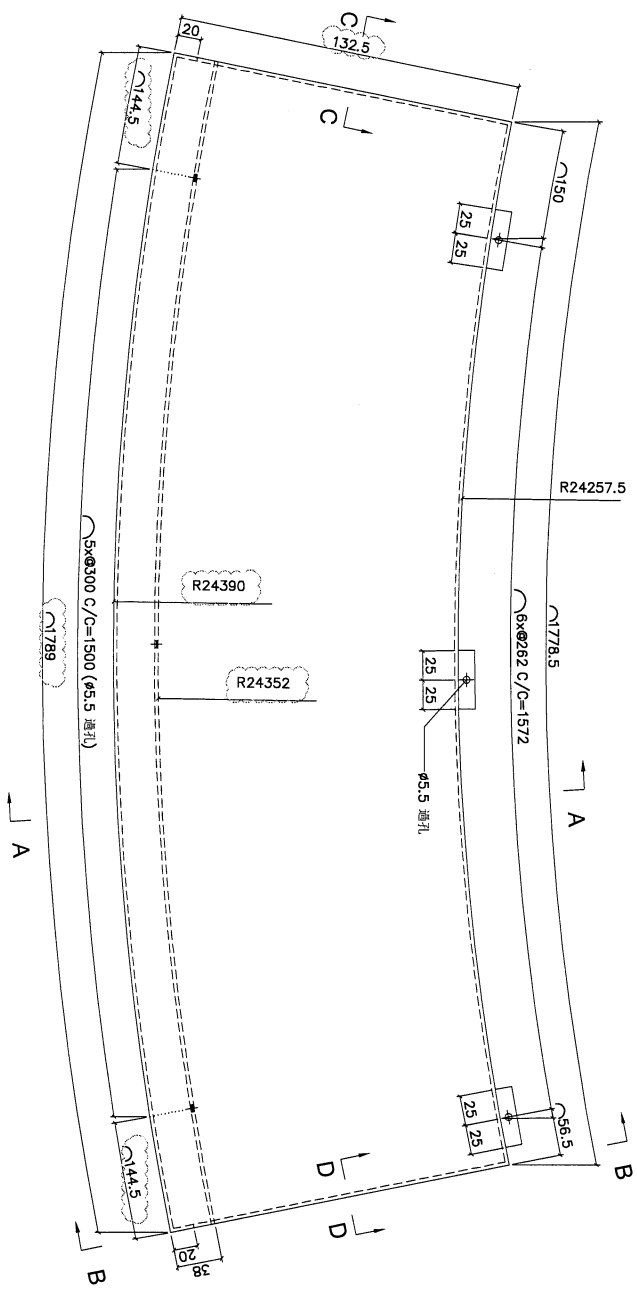

| | | | | | | | | | | | |
|----------|---------|------|---|-------|--|------|------------|----------|--|-------------|--|
| DWG. NO. | FW-T104 | REV. | A | SCALE | | DATE | 06-07-2024 | DRAWN BY | | APPROVED BY | |
|----------|---------|------|---|-------|--|------|------------|----------|--|-------------|--|

PROJECT
YIN PING ROAD KOWLOON
FEATURE WALL (PHASE 2)

MATERIAL
3mm铝板

COATING
PVF2

COLOUR
EG-DG-D334232-ZD1(SS-01)

MARK. NO.
-

QTY.
-

| REV. | CHANGED BY | PART NUMBER | Dim. A | Dim. B | Dim. C | Dim. D | Dim. E | Dim. F | Dim. G | Dim. H | QTY. | Inv. Code | ASSEMBLE ON PARTS |
|------|---------------|-------------|--------|--------|--------|--------|--------|--------|--------|--------|------|-----------|-------------------|
| - | | FW-T105 | - | - | - | - | - | - | - | - | 1 | | 注：用于B区域 |

地盤用

用A3紙打印

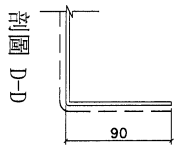
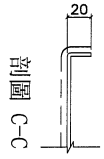
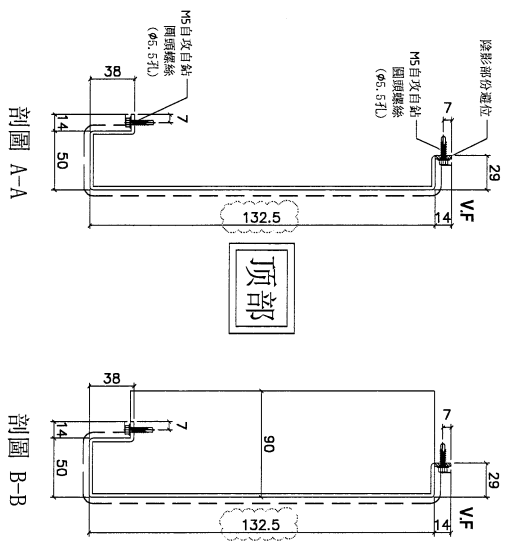
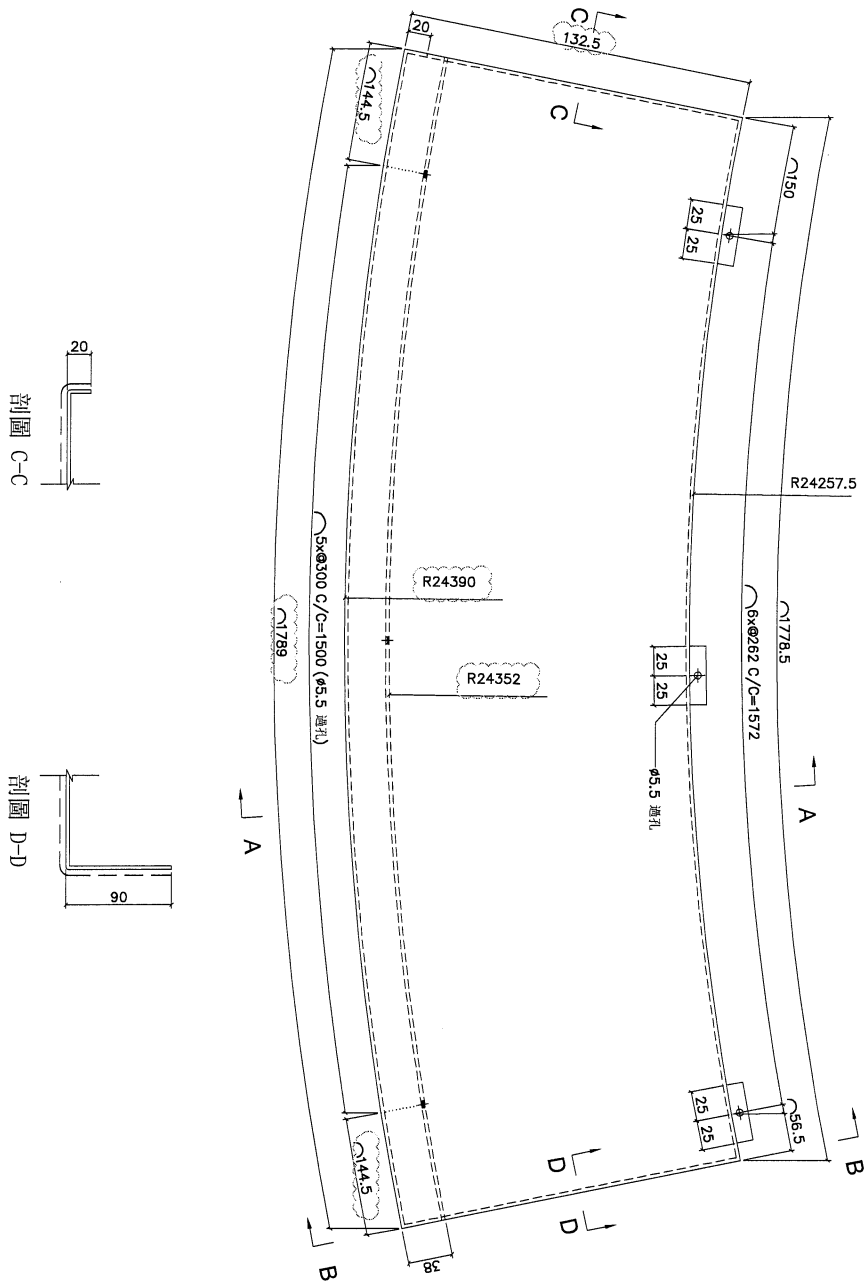

DWG. NO.

FW-T105

REV.
A

SCALE
-

DATE
06-07-2024

DRAWN BY
-

APPROVED BY
-

PROJECT
YIN PING ROAD KOWLOON
FEATURE WALL (PHASE 2)

MATERIAL
3mm铝板

COATING
PVF2

COLOUR
EC-DG-D334232-ZD1(SS-01)

MARK. NO.
-

QTY.
-

| REV. / 修改 | DATE / 日期 | DESCRIPTION / 描述 | QTY. | Inv. Code | ASSEMBLE ON PARTS |
|-----------|-----------|------------------|------|-----------|-------------------|
| FW-T106 | - | - | 1 | - | ASSEMBLE ON PARTS |

地盤用

用A3紙打印

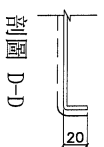
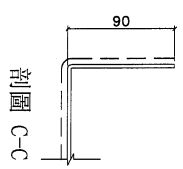
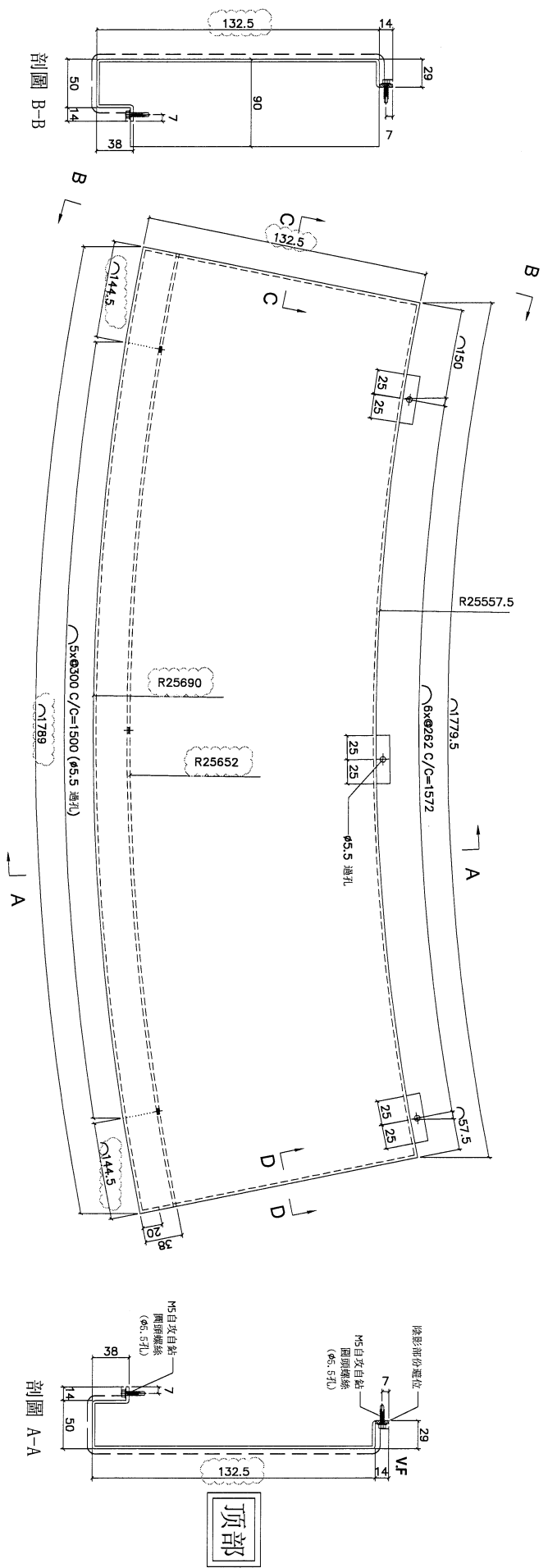

| | | | | | | | | | | | |
|----------|---------|------|---|-------|---|------|------------|----------|---|-------------|---|
| DWG. NO. | FW-T106 | REV. | A | SCALE | - | DATE | 06-07-2024 | DRAWN BY | - | APPROVED BY | - |
|----------|---------|------|---|-------|---|------|------------|----------|---|-------------|---|

PROJECT
YIN PING ROAD KOWLOON
FEATURE WALL (PHASE 2)

MATERIAL
3mm铝板

COATING
PVF2

COLOUR
EC-DG-D34232-ZD1(SS-01)

MARK. NO.
-

QTY.
-

| REV. | CHECKED DWG BY | PART NUMBER | Dim. A | Dim. B | Dim. C | Dim. D | Dim. E | Dim. F | Dim. G | Dim. H | QTY. | Inv. Code | ASSEMBLE ON PARTS |
|------|-------------------|-------------|--------|--------|--------|--------|--------|--------|--------|--------|------|-----------|-------------------|
| - | | FW-1107 | - | - | - | - | - | - | - | - | 4 | | 注：用于A区域 |

地盘用

用A3纸打印

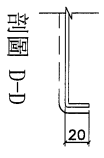
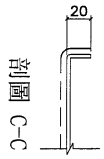
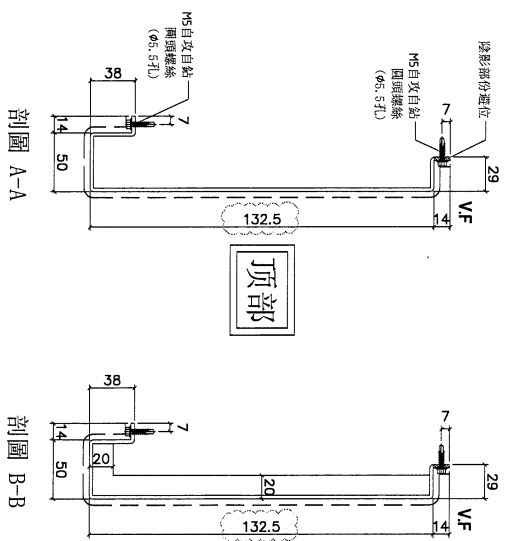
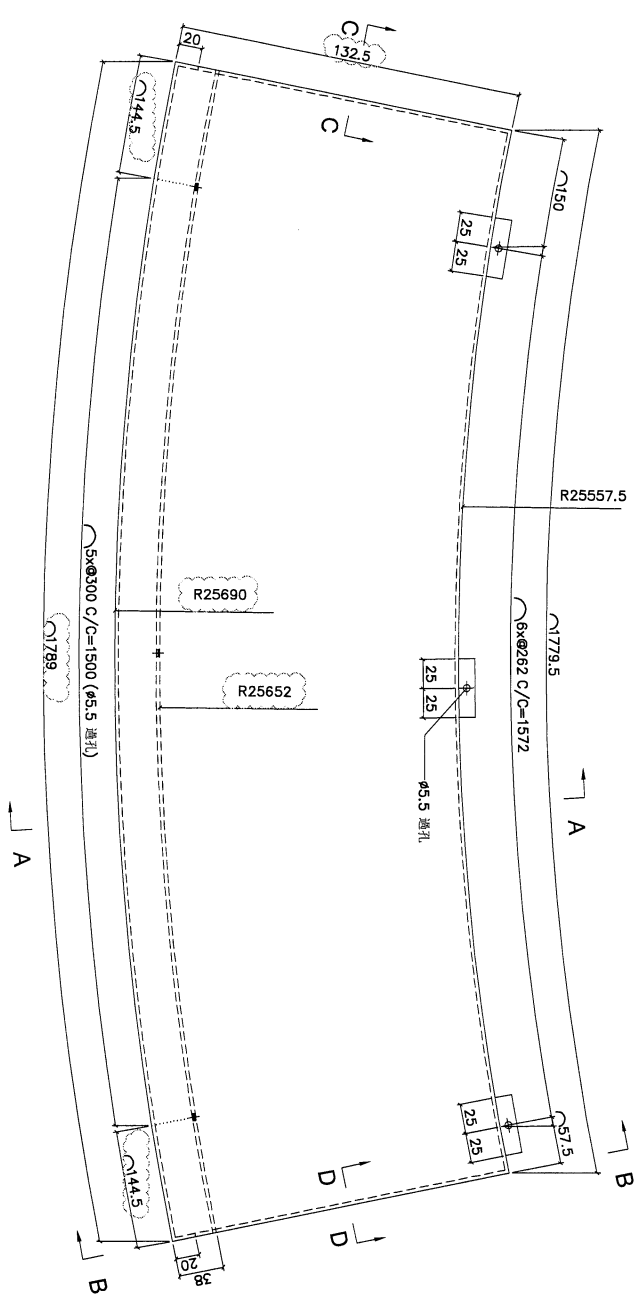

| | | | | | | | | | | | |
|----------|---------|------|---|-------|---|------|------------|----------|---|-------------|---|
| DWG. NO. | FW-1107 | REV. | A | SCALE | - | DATE | 06-07-2024 | DRAWN BY | - | APPROVED BY | - |
|----------|---------|------|---|-------|---|------|------------|----------|---|-------------|---|

| | | | | | | | | | | | | | | | | | | | | | | | | | | | | | | | | | | | | | | | | | | | | | | | | | | | | | | | | | | | |
|-----------------------|--|--|--|---|--|--|--|----------|--|--|--|--------|--|--|--|---------|--|--|--|--------|--|--|--|--------|--|--|--|--------------------------|--|--|--|-----------|--|--|--|--------|--|--|--|------|--|--|--|-----------|--|--|--|-------------------|--|--|--|-----|--|--|--|--------|--|--|--|
| PROJECT | | | | YIN PING ROAD KOWLOON FEATURE WALL (PHASE 2) | | | | MATERIAL | | | | 3mm铝板 | | | | COATING | | | | PVF2 | | | | COLOUR | | | | EC-DG-D334232-ZD1(SS-01) | | | | MARK. NO. | | | | QTY. | | | | | | | | | | | | | | | | | | | | | | | |
| REV. / CHECKED / DATE | | | | PART NUMBER | | | | Dim. A | | | | Dim. B | | | | Dim. C | | | | Dim. D | | | | Dim. E | | | | Dim. F | | | | Dim. G | | | | Dim. H | | | | QTY. | | | | Inv. Code | | | | ASSEMBLE ON PARTS | | | | 地盤用 | | | | 用A3紙打印 | | | |
| - | | | | FW-T109 | | | | - | | | | - | | | | - | | | | - | | | | - | | | | - | | | | - | | | | - | | | | 1 | | | | | | | | 注：用于A区域 | | | | - | | | | - | | | |

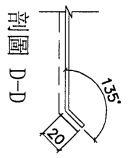
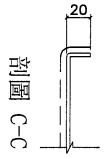
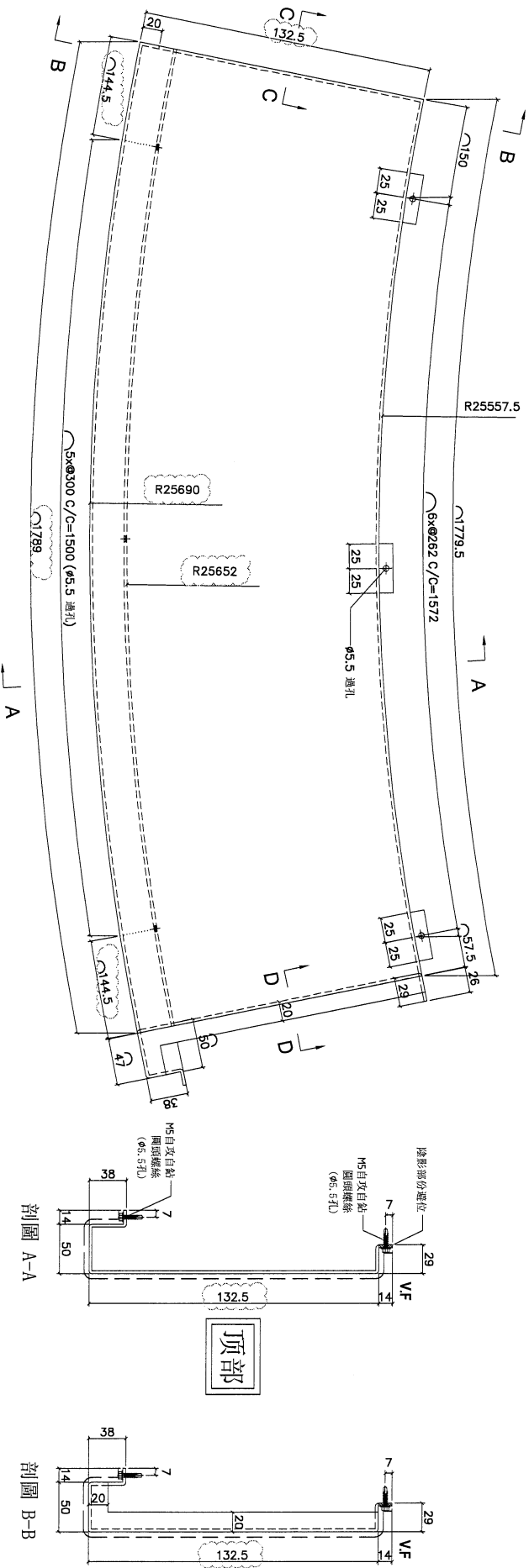

剖面 A-A

剖面 B-B

| | | | | | | | | | | | | | | | | | |
|----------|--|---------|--|------|--|---|--|-------|--|------|--|------------|--|----------|--|-------------|--|
| DWG. NO. | | FW-T109 | | REV. | | A | | SCALE | | DATE | | 06-07-2024 | | DRAWN BY | | APPROVED BY | |
|----------|--|---------|--|------|--|---|--|-------|--|------|--|------------|--|----------|--|-------------|--|

PROJECT
YIN PING ROAD KOWLOON
FEATURE WALL (PHASE 2)

MATERIAL
3mm铝板

COATING
PVF2

COLOUR
EC-DG-D334232-ZD1 (SS-01)

MARK. NO.
-

QTY.
-

| CHECKED BY | PART NUMBER | Dim. A | Dim. B | Dim. C | Dim. D | Dim. E | Dim. F | Dim. G | Dim. H | QTY. | Inv. Code | ASSEMBLE ON PARTS |
|---------------|-------------|--------|--------|--------|--------|--------|--------|--------|--------|------|-----------|-------------------|
| - | FW-T110 | - | - | - | - | - | - | - | - | 1 | - | ASSEMBLE ON PARTS |

注：用于A区域

地盤用

用A3紙打印

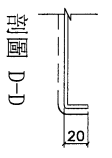
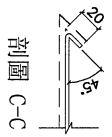
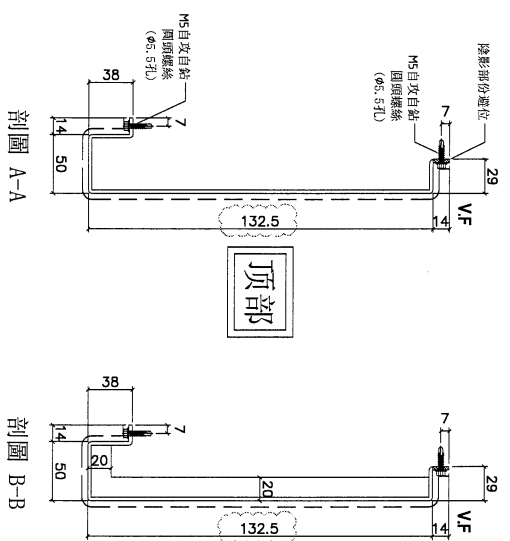
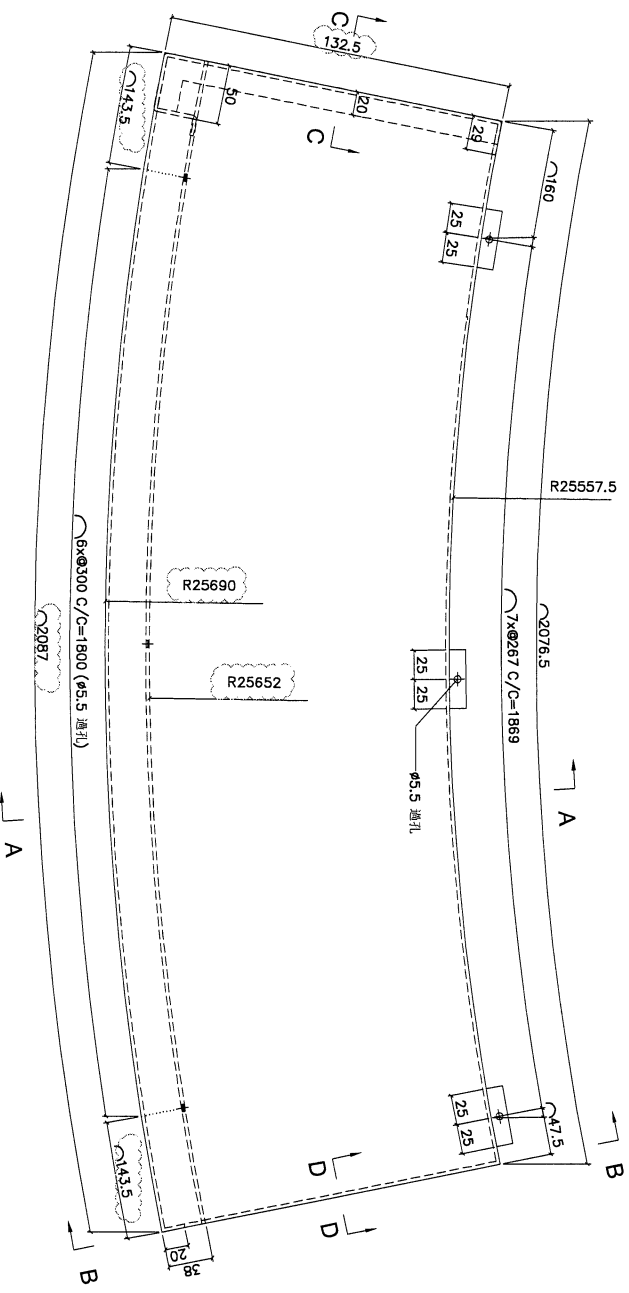

DWG. NO. FW-T110

REV. A

SCALE -

DATE 06-07-2024

DRAWN BY -

APPROVED BY -

PROJECT
YIN PING ROAD KOWLOON
FEATURE WALL (PHASE 2)

MATERIAL
3mm铝板

COATING
PVF2

COLOUR
EC-DG-D334232-ZD1(SS-011)

MARK. NO.
-

QTY.
-

| CHKD DATE BY | PART NUMBER | Dim. A | Dim. B | Dim. C | Dim. D | Dim. E | Dim. F | Dim. G | Dim. H | QTY. | Inv. Code | ASSEMBLE ON PARTS |
|-----------------|-------------|--------|--------|--------|--------|--------|--------|--------|--------|------|-----------|-------------------|
| - | FW-T111 | - | - | - | - | - | - | - | - | 1 | - | (注:用于B区域) |

地盤用

用A3紙打印

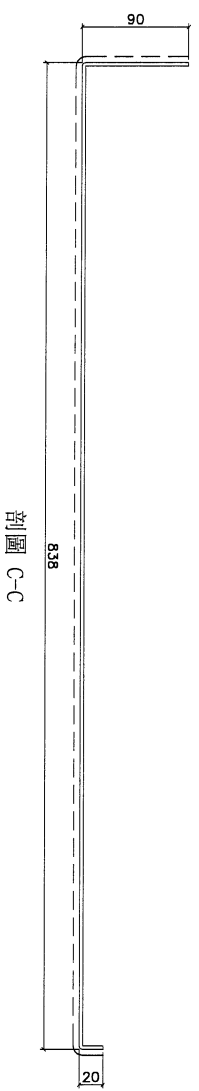
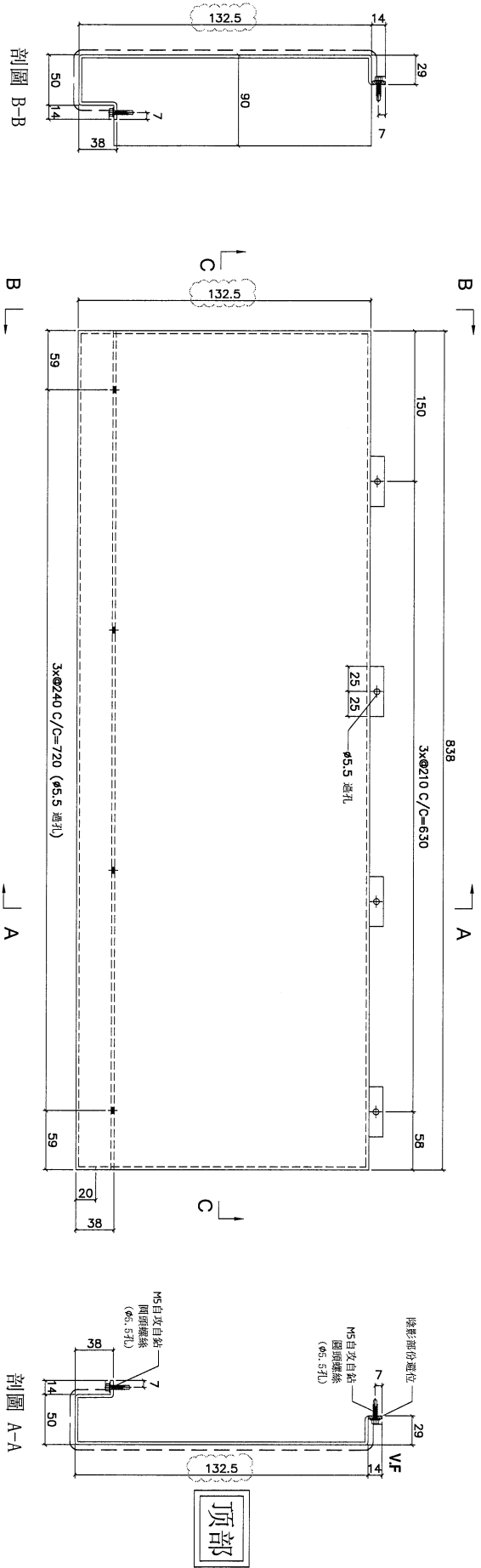

剖面 C-C

剖面 A-A

剖面 B-B

顶部

| | | | | | |
|----------|------|-------|------------|----------|-------------|
| DWG. NO. | REV. | SCALE | DATE | DRAWN BY | APPROVED BY |
| FW-T111 | A | - | 06-07-2024 | - | - |

| | | | | | | | | | | | | | | | | | | | | | | | | | | | | | | | | | | | | | | | | | | | | | | | |
|---------|---------|---------|-------------|---|--------|--------|--------|----------|--------|--------|--------|-------|-----------|-------------------|--|---------|--|--|--|------|--|--|--|--------|--|--|--|--------------------------|--|--|--|-----------|--|--|--|---|--|--|--|------|--|--|--|---|--|--|--|
| PROJECT | | | | YIN PING ROAD KOWLOON FEATURE WALL (PHASE 2) | | | | MATERIAL | | | | 3mm铝板 | | | | COATING | | | | PVF2 | | | | COLOUR | | | | EC-DG-D334232-ZD1(SS-01) | | | | MARK. NO. | | | | - | | | | QTY. | | | | - | | | |
| REV. | CHECKED | DWG. BY | PART NUMBER | Dim. A | Dim. B | Dim. C | Dim. D | Dim. E | Dim. F | Dim. G | Dim. H | QTY. | Inv. Code | ASSEMBLE ON PARTS | | | | | | | | | | | | | | | | | | | | | | | | | | | | | | | | | |
| - | | | FW-T112 | - | - | - | | | | | | 1 | | 注：用于B区域 | | | | | | | | | | | | | | | | | | | | | | | | | | | | | | | | | |
| | | | | | | | | | | | | | | | | 地盤用 | | | | | | | | | | | | | | | | 用A3紙打印 | | | | | | | | | | | | | | | |

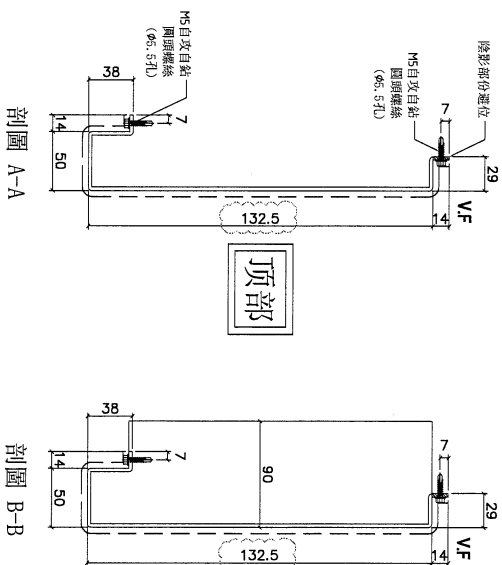
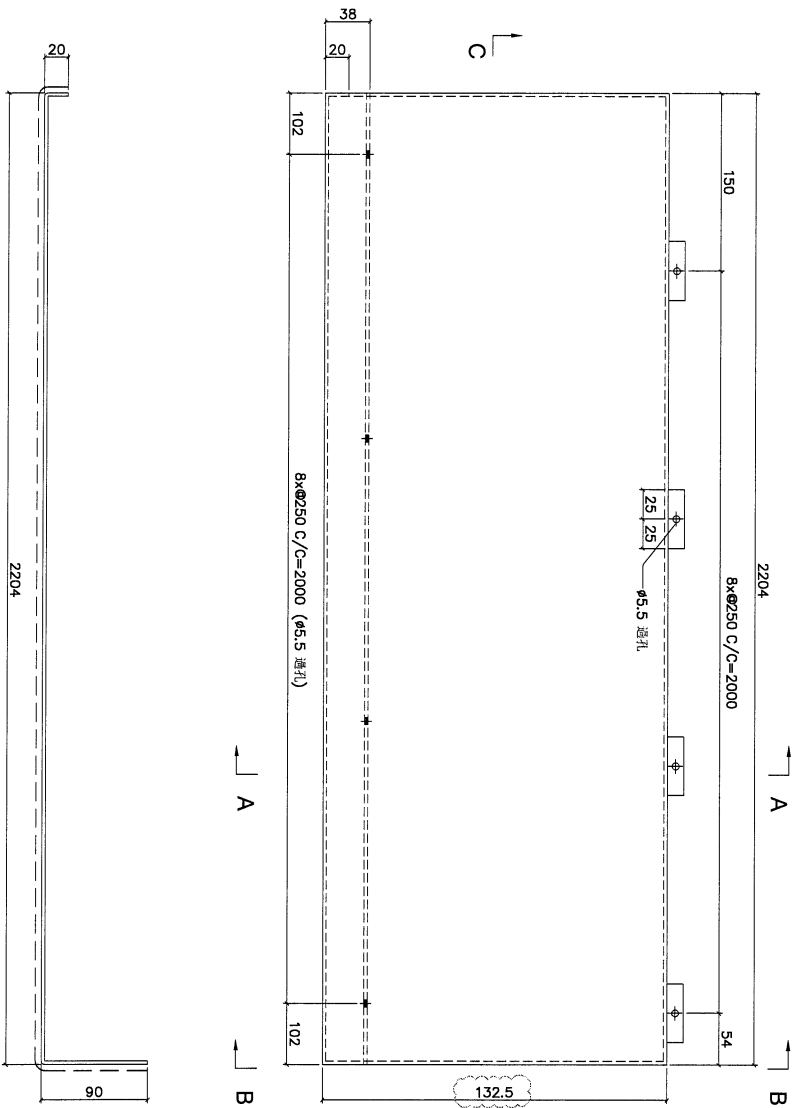

剖面 C-C

剖面 A-A

剖面 B-B

DWG. NO.

FW-T112

REV. A

SCALE

DATE 06-07-2024

DRAWN BY

APPROVED BY

PROJECT
YIN PING ROAD KOWLOON
FEATURE WALL (PHASE 2)

MATERIAL
3mm铝板

COATING
PVF2

COLOUR
EC-DG-D334232-ZD1(SS-01)

MARK. NO.
-

QTY.
-

| REV. | CHECKED DATE BY | PART NUMBER | Dim. A | Dim. B | Dim. C | Dim. D | Dim. E | Dim. F | Dim. G | Dim. H | QTY. | Inv. Code | ASSEMBLE ON PARTS |
|------|--------------------|-------------|--------|--------|--------|--------|--------|--------|--------|--------|------|-----------|-------------------|
| - | | FW-T113 | - | - | - | - | - | - | - | - | 1 | | 注：用于A区域 |

地盤用

用A3紙打印

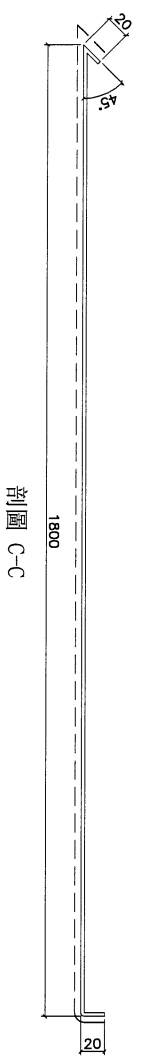
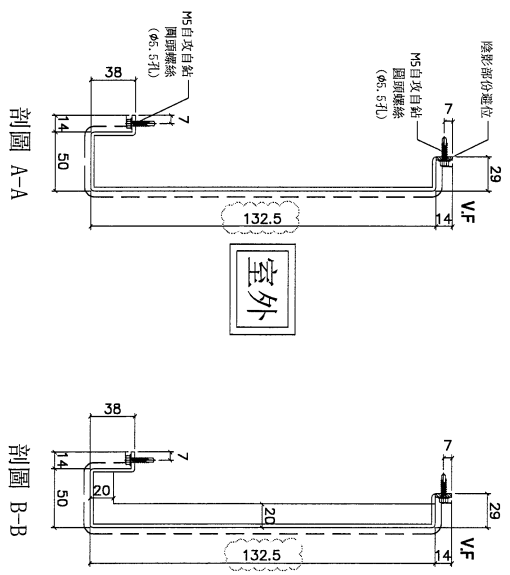
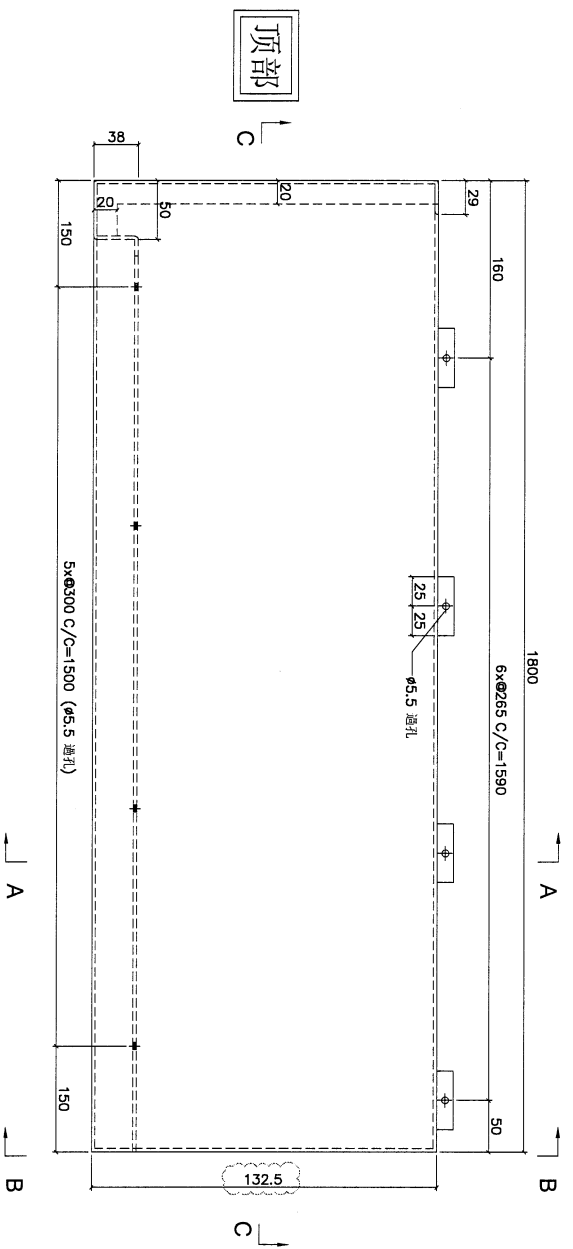

| | | | | | | | | | | | |
|----------|---------|------|---|-------|---|------|------------|----------|---|-------------|---|
| DWG. NO. | FW-T113 | REV. | A | SCALE | - | DATE | 06-07-2024 | DRAWN BY | - | APPROVED BY | - |
|----------|---------|------|---|-------|---|------|------------|----------|---|-------------|---|

| | | | | | | | | | | | | | | | | | | | |
|---|--------------------|-------------|--------|----------|--------|--------|--------|---------|--------|--------|------|--------------------------|-------------------|--|--------|-----------|-----|------|--|
| PROJECT | | | | MATERIAL | | | | COATING | | | | COLOUR | | | | MARK. NO. | | QTY. | |
| YIN PING ROAD KOWLOON FEATURE WALL (PHASE 2) | | | | 3mm铝板 | | | | PVF2 | | | | EC-DG-D334232-ZD1(SS-01) | | | | - | | - | |
| REV. | CHECKED DATE BY | PART NUMBER | Dim. A | Dim. B | Dim. C | Dim. D | Dim. E | Dim. F | Dim. G | Dim. H | QTY. | Inv. Code | ASSEMBLE ON PARTS | | | | | | |
| - | | FW-T115 | - | - | - | - | - | - | - | - | 1 | | 注：用于B区域 | | | | 地盤用 | | |
| | | | | | | | | | | | | | | | 用A3紙打印 | | | | |

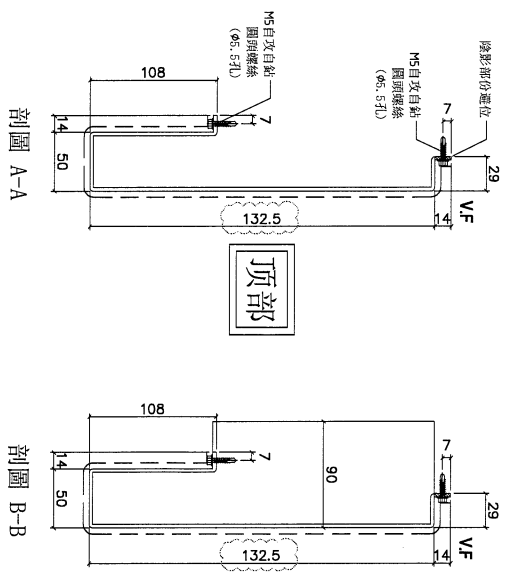
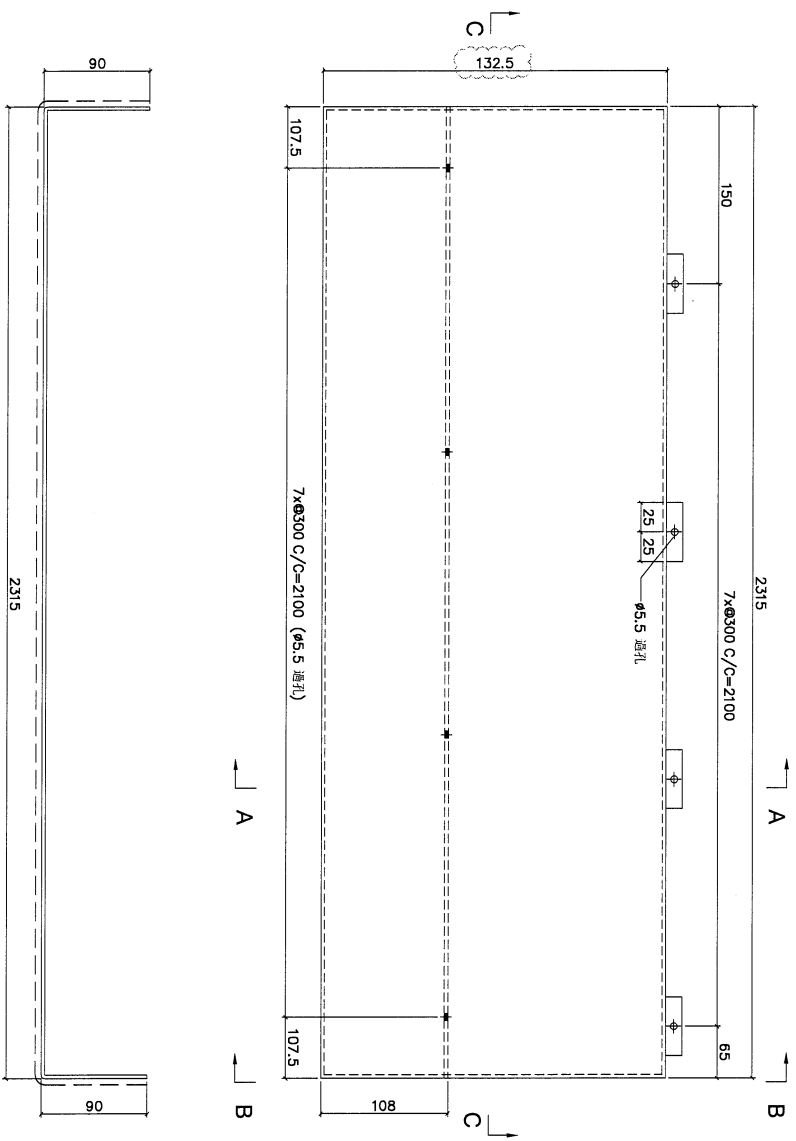

| | | | | | | | | | | | |
|----------|--|------|--|-------|--|------------|--|----------|--|-------------|--|
| DWG. NO. | | REV. | | SCALE | | DATE | | DRAWN BY | | APPROVED BY | |
| FW-T115 | | A | | - | | 06-07-2024 | | - | | - | |

PROJECT YIN PING ROAD KOWLOON
FEATURE WALL (PHASE 2)

MATERIAL 3mm铝板

COATING PVF2

COLOUR EC-DG-D34232-ZD1(SS-01)

MARK. NO. -

QTY. -

| REV. OR/ENGD BY | PART NUMBER | Dim. A | Dim. B | Dim. C | Dim. D | Dim. E | Dim. F | Dim. G | Dim. H | QTY. | Inv. Code | ASSEMBLE ON PARTS |
|-----------------|-------------|--------|--------|--------|--------|--------|--------|--------|--------|------|-----------|-------------------|
| - | FW-T301 | - | - | - | - | - | - | - | - | 2 | - | 注：用于B区域 |

地盤用

用A3紙打印

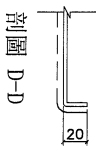
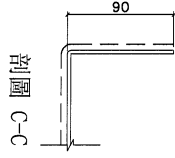
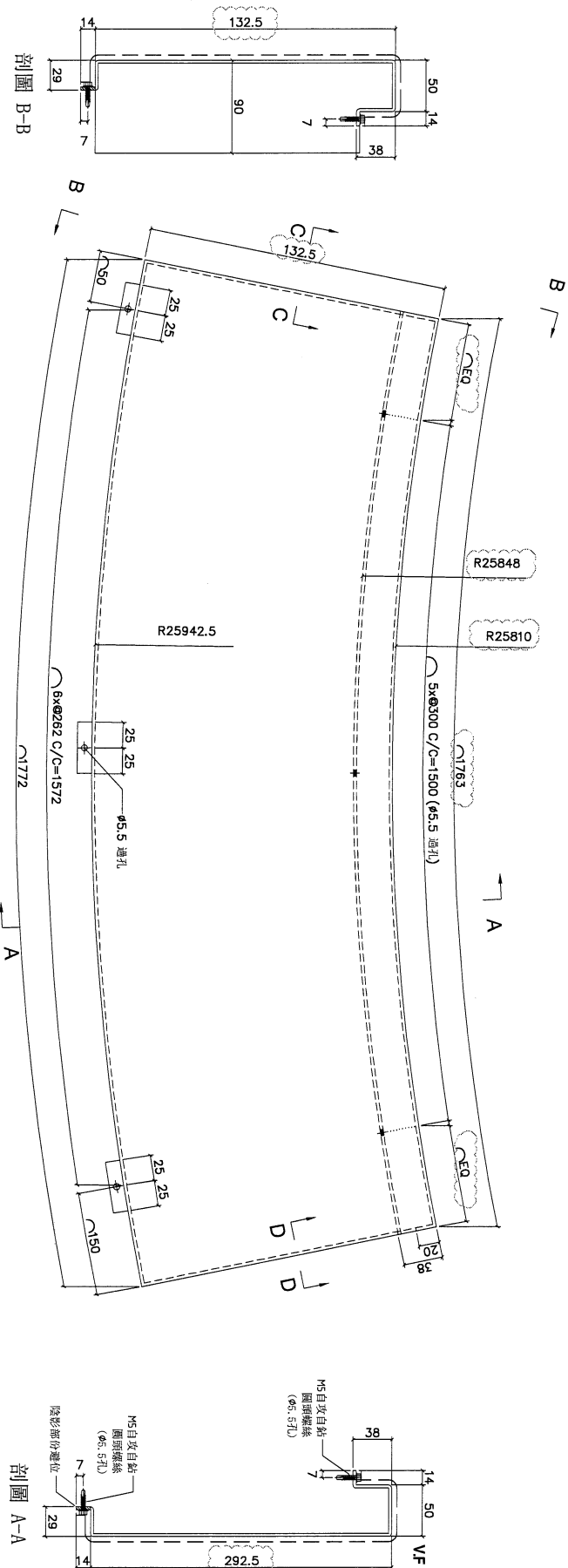

DWG. NO.

FW-T301

REV. A

SCALE -

DATE 06-07-2024

DRAWN BY -

APPROVED BY -

PROJECT YIN PING ROAD KOWLOON
FEATURE WALL (PHASE 2)

MATERIAL 3mm铝板

COATING PVF2

COLOUR EC-DG-D34232-ZD1(SS-01)

MARK. NO. -

QTY. -

| REV. | CHECKED DATE BY | PART NUMBER | Dim. A | Dim. B | Dim. C | Dim. D | Dim. E | Dim. F | Dim. G | Dim. H | QTY. | Inv. Code | ASSEMBLE ON PARTS |
|------|--------------------|-------------|--------|--------|--------|--------|--------|--------|--------|--------|------|-----------|-------------------|
| - | | FW-T302 | - | - | - | - | - | - | - | - | 4 | | 注：用于B区域 |

地盤用

用A3紙打印

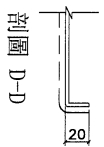
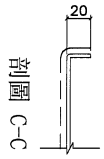
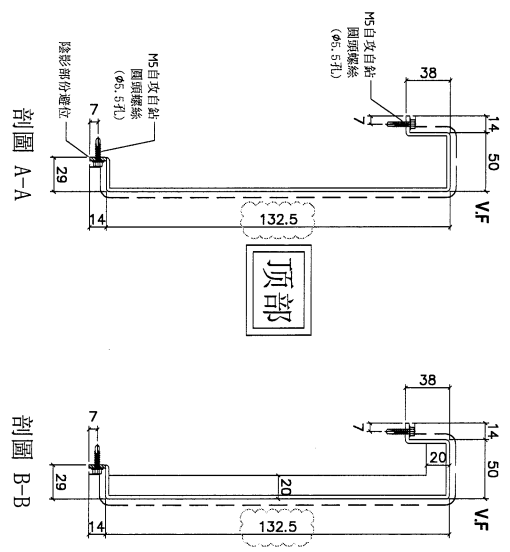
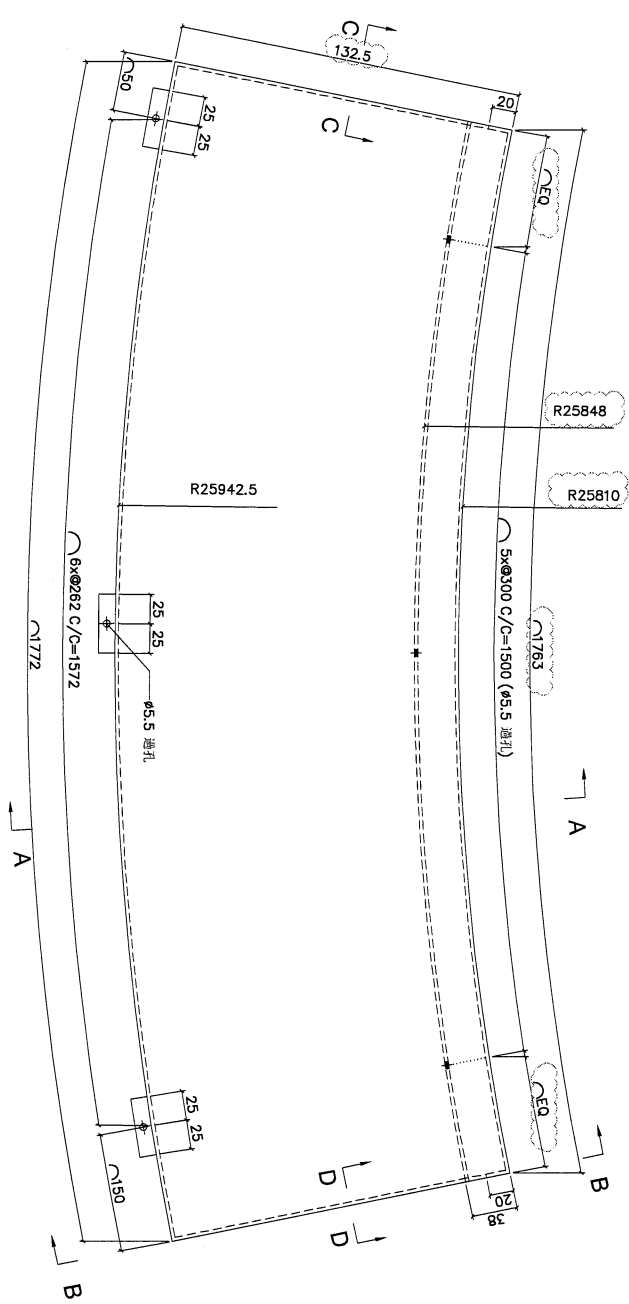

| | | | | | | | | | | | |
|----------|---------|------|---|-------|---|------|------------|----------|---|-------------|---|
| DWG. NO. | FW-T302 | REV. | A | SCALE | - | DATE | 06-07-2024 | DRAWN BY | - | APPROVED BY | - |
|----------|---------|------|---|-------|---|------|------------|----------|---|-------------|---|

