

工程指示 / 要求簡箋 ENGINEER INSTRUCTIONS(E.I.)

工程指示編號:	EI- 2038	修改版本:	-
	HK- 1285		
工程編號:	J 853	工程名稱:	延坪道 (第2期)
收件人:	Maggie Lov	發件人:	Jingo
工程項目:	Feature Wall 飾線 彩釉圓玻璃樣板 及大貨 廠用	日期:	10/7/2024

<input type="checkbox"/> 原合約工程包	<input type="checkbox"/> 原合約工程加 / 減賬 QT-	<input type="checkbox"/> 新工程報價 QT-
---------------------------------	--	------------------------------------

信件批核號碼/圖紙參考編號:	批核模具圖紙編號:
客戶指示附件:	管理內部批簽署:

<input type="checkbox"/> 初步鋁料 B.M.	<input type="checkbox"/> 加工拆圖, 然後生產	<input type="checkbox"/> 尺寸表
<input type="checkbox"/> 正式鋁料 B.M.	<input type="checkbox"/> 技術上資料/指示	<input type="checkbox"/> 報價
<input type="checkbox"/> 配件 B.M.	<input type="checkbox"/> 樣辦或貨品說明書	<input type="checkbox"/> 分判合約
<input type="checkbox"/> 其他:		

內容: 1. 先做樣板, 確認效果後才可做大貨  
G1-4018-11  
2. 大貨:

完成上列要求日期: 26/7/2024

國內

<input type="checkbox"/> 生產技術總監	<input type="checkbox"/> 連附件	<input type="checkbox"/> 技術部	<input type="checkbox"/> 連附件	<input type="checkbox"/> 生產部	<input type="checkbox"/> 連附件
<input type="checkbox"/> 採購部	<input type="checkbox"/> 連附件	<input checked="" type="checkbox"/> 生產統籌部	<input checked="" type="checkbox"/> 連附件	<input type="checkbox"/> 報關組	<input type="checkbox"/> 連附件
<input type="checkbox"/> 質檢部	<input type="checkbox"/> 連附件	<input type="checkbox"/> 會計部	<input type="checkbox"/> 連附件	<input type="checkbox"/> 機械設計部	<input type="checkbox"/> 連附件
<input type="checkbox"/> 香港辦	<input type="checkbox"/> 連附件	<input type="checkbox"/> 其他:			

香港

<input type="checkbox"/> 行政部	<input type="checkbox"/> 連附件	<input type="checkbox"/> 會計部	<input type="checkbox"/> 連附件	<input type="checkbox"/> 統籌部	<input type="checkbox"/> 連附件	<input type="checkbox"/> 工程部	<input type="checkbox"/> 連附件
<input checked="" type="checkbox"/> 採購部	<input checked="" type="checkbox"/> 連附件	<input type="checkbox"/> QS部	<input type="checkbox"/> 連附件	<input checked="" type="checkbox"/> 地盤管理	<input type="checkbox"/> 連附件	<input type="checkbox"/> 維修部	<input type="checkbox"/> 連附件

*發件人簽署:	*組別成員批核簽署: Jingo
傳遞編號:	項目經理簽署:

		Project No.:		J-853											
		Project Title:		延平道											
		Table:		Alum feature at Phase 2 玻璃BOM											
玻璃规格	G1:6mm + 1.52PVB + 6mm THK. LAMINATED TEMPERED GLASS WITH SILK PAINTING					制表:	XIAO	日期:	2024/7/3			文件编号:	GL01		
						审核:		日期:				表单编号:			
						修改:		日期:							
玻璃编号	玻璃尺寸			分仓尺寸		面积 (m <sup>2</sup> )	单件重量 (Kg)	总数量 (件)	位置			总重量 (Kg)	总面积 (m <sup>2</sup> )	送货地点	备注
	W(mm)	H(mm)	直径	宽度 (mm)	高度 (mm)				4017	4018	4019				
G1-4017-1	1620	1620	1620			2.061	63.3	1	1			63.3	2.061	工厂	参照加工图 G1-4017-1
G1-4017-2	1620	1620	1620			2.061	63.3	1	1			63.3	2.061	工厂	参照加工图 G1-4017-2
G1-4017-3	1620	1620	1620			2.061	63.3	1	1			63.3	2.061	工厂	参照加工图 G1-4017-3
G1-4017-4	1620	1620	1620			2.061	63.3	1	1			63.3	2.061	工厂	参照加工图 G1-4017-4
G1-4017-5	1620	1620	1620			2.061	63.3	1	1			63.3	2.061	工厂	参照加工图 G1-4017-5
G1-4017-6	1620	1620	1620			2.061	63.3	1	1			63.3	2.061	工厂	参照加工图 G1-4017-6
G1-4018-7	1620	1620	1620			2.061	63.3	1		1		63.3	2.061	工厂	参照加工图 G1-4018-7
G1-4018-8	1620	1620	1620			2.061	63.3	1		1		63.3	2.061	工厂	参照加工图 G1-4018-8
G1-4018-9	1620	1620	1620			2.061	63.3	1		1		63.3	2.061	工厂	参照加工图 G1-4018-9
G1-4018-10	1620	1620	1620			2.061	63.3	1		1		63.3	2.061	工厂	参照加工图 G1-4018-10
G1-4018-11	1620	1620	1620			2.061	63.3	1		1		63.3	2.061	工厂	参照加工图 G1-4018-11
G1-4018-12	1620	1620	1620			2.061	63.3	1		1		63.3	2.061	工厂	参照加工图 G1-4018-12
G1-4019-13	1620	1620	1620			2.061	63.3	1			1	63.3	2.061	工厂	参照加工图 G1-4019-13
G1-4019-14	1620	1620	1620			2.061	63.3	1			1	63.3	2.061	工厂	参照加工图 G1-4019-14
G1-4019-15	1620	1620	1620			2.061	63.3	1			1	63.3	2.061	工厂	参照加工图 G1-4019-15
G1-4019-16	1620	1620	1620			2.061	63.3	1			1	63.3	2.061	工厂	参照加工图 G1-4019-16
G1-4019-17	1620	1620	1620			2.061	63.3	1			1	63.3	2.061	工厂	参照加工图 G1-4019-17
G1-4019-18	1620	1620	1620			2.061	63.3	1			1	63.3	2.061	工厂	参照加工图 G1-4019-18
合计:								18				1139.8	37.1		

PROJECT YIN PING ROAD KOWLOON FEATURE WALL (PHASE 2)

MARK. NO.	COLOUR	QTY.
—	—	—
COATING	MATERIAL	ASSEMBLE ON PARTS
—	GLASS WITH SILK PAINTING	
Inv. Code	Dim. H	QTY.
—	—	1
Dim. G	Dim. F	
—	—	
Dim. E	Dim. D	
—	—	
Dim. C	Dim. B	
—	—	
Dim. A	Dim. A	
—	—	
PART NUMBER	Dim. A	Dim. B
G1-4017-1	—	—
CHECKED BY	Dim. C	Dim. D
—	—	—
REV.	Dim. E	Dim. F
—	—	—

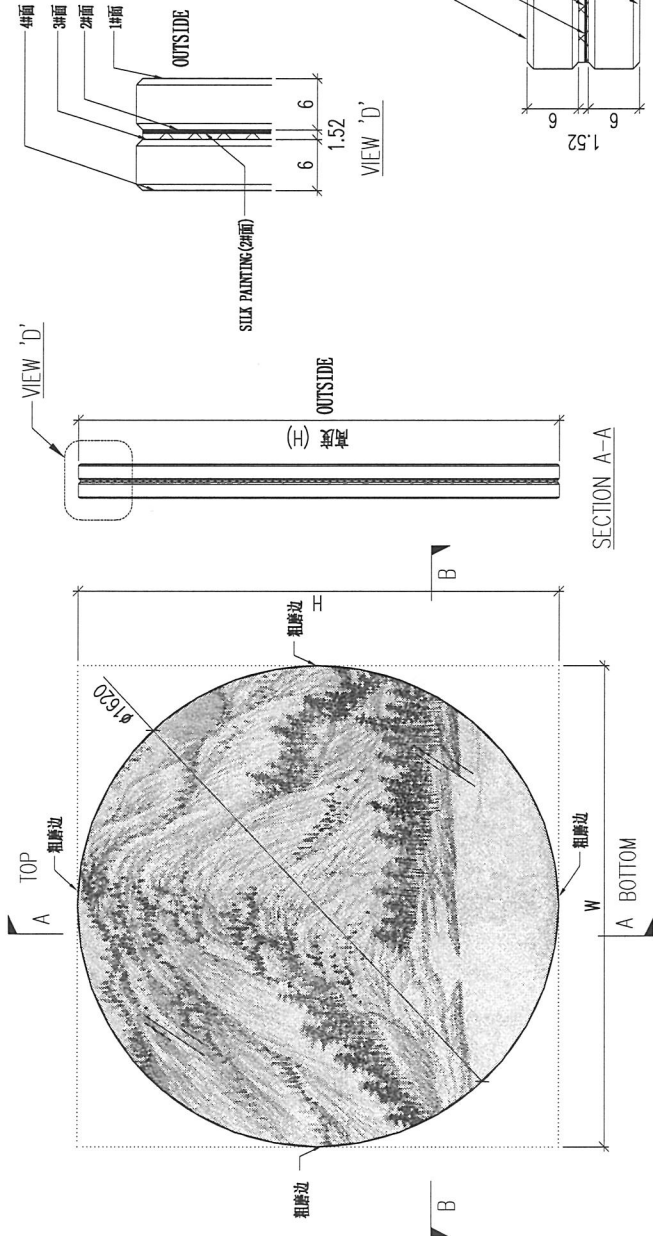

VIEW 'D'

VIEW 'C'

6mm THK. TEMPERED GLASS  
SILK PAINTING (2#面)  
1.52 PVB  
6mm THK. TEMPERED GLASS

6mm+1.52PVB+6mm THK. LAMINATED TEMPERED GLASS

注：  
1、在左上角贴上编号

SECTION A-A

SECTION B-B

DWG. NO.	REV.	SCALE	DATE	DRAWN BY	APPROVED BY
G1-4017-1	—	—	03-07-2024	—	—

PROJECT: YIN PING ROAD KOWLOON FEATURE WALL (PHASE 2)

REV.	CHANGED BY	Dim. A	Dim. B	Dim. C	Dim. D	Dim. E	Dim. F	Dim. G	Dim. H	QTY.	Inv. Code	COLOUR	MARK. NO.	QTY.
-										1		ASSEMBLE ON PARTS	-	-

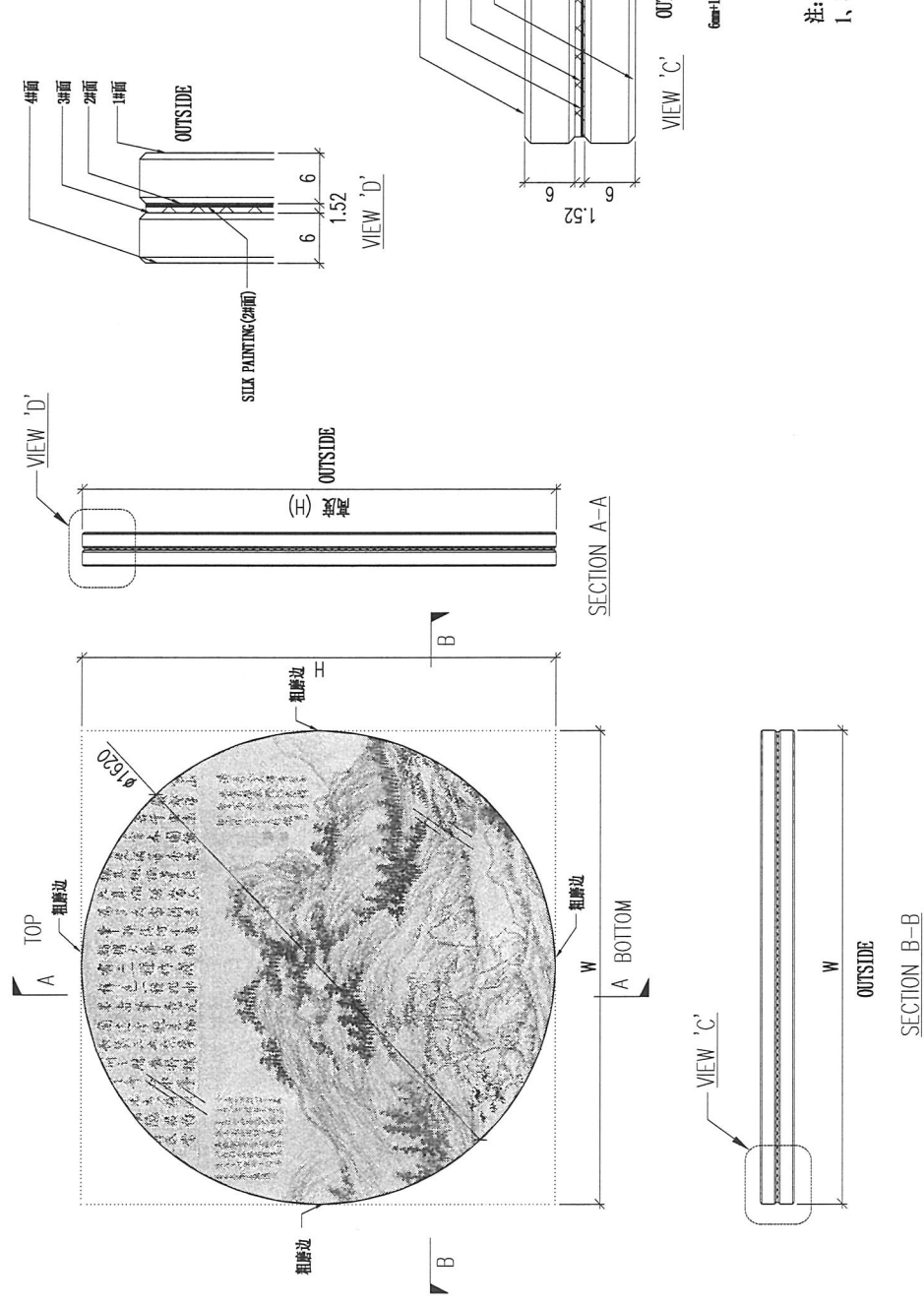

DWG. NO.	REV.	SCALE	DATE	DRAWN BY	APPROVED BY
G1-4017-2	-	-	03-07-2024	-	-

PROJECT: YIN PING ROAD KOWLOON FEATURE WALL (PHASE 2)

REV.	CHANGED BY	PART NUMBER	Dim. A	Dim. B	Dim. C	Dim. D	Dim. E	Dim. F	Dim. G	Dim. H	QTY.	Inv. Code	ASSEMBLE ON PARTS	COLOUR	MARK. NO.	QTY.
-		G1-4017-3									1					

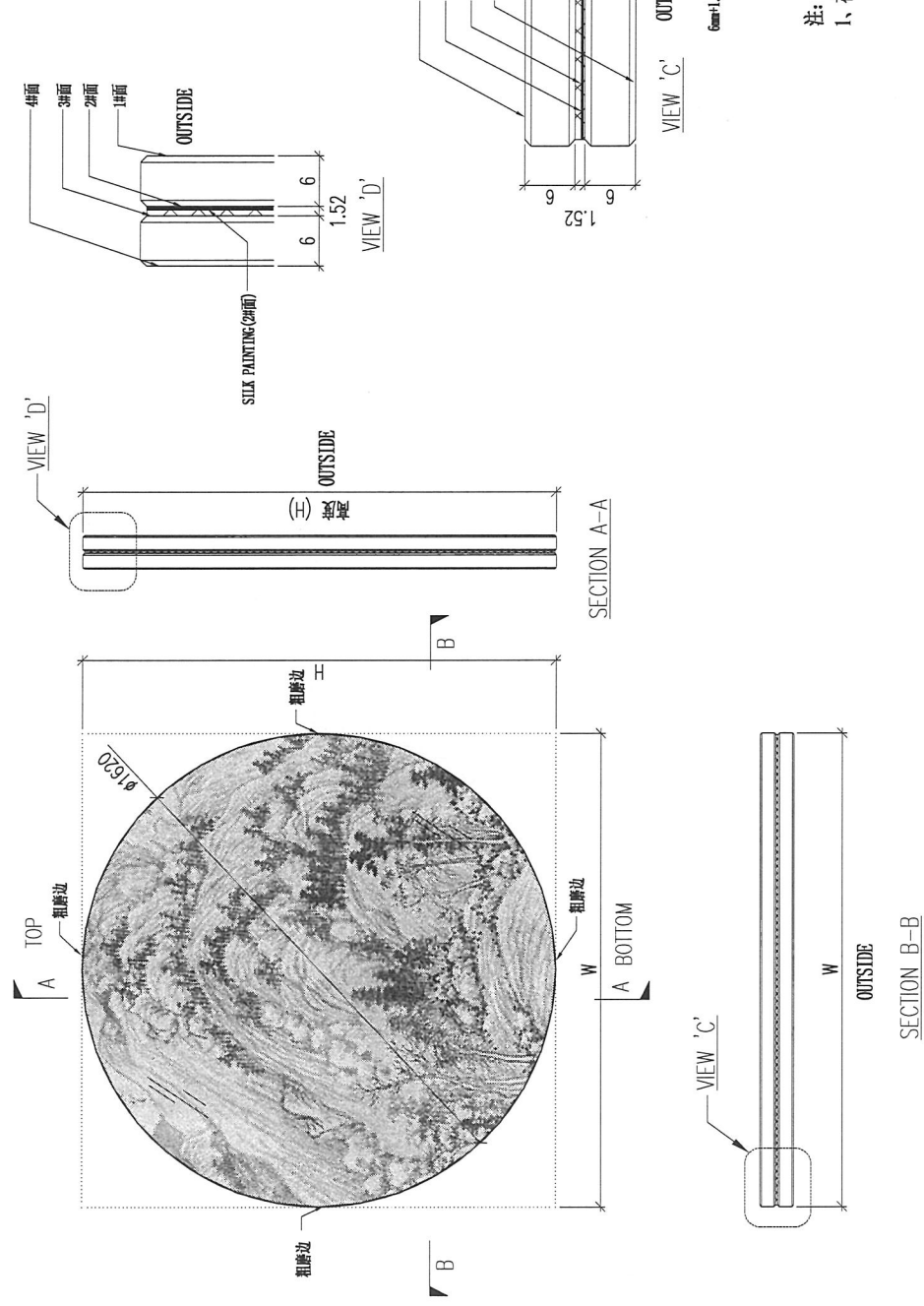

注:  
1、在左上角贴上编号

DWG. NO.	G1-4017-3	REV.	-	SCALE	-	DATE	03-07-2024	DRAWN BY	-	APPROVED BY	-
----------	-----------	------	---	-------	---	------	------------	----------	---	-------------	---

PROJECT: YIN PING ROAD KOWLOON FEATURE WALL (PHASE 2)

REV.	CHECKED DATE	Dim. A	Dim. B	Dim. C	Dim. D	Dim. E	Dim. F	Dim. G	Dim. H	QTY.	Inv. Code	COLOUR	MARK. NO.	QTY.
-										1		ASSEMBLE ON PARTS	-	-

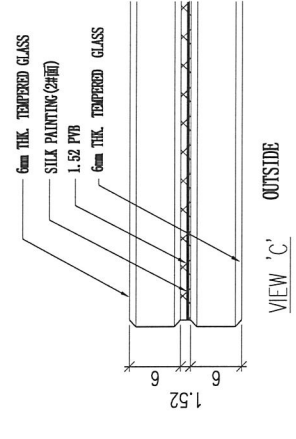
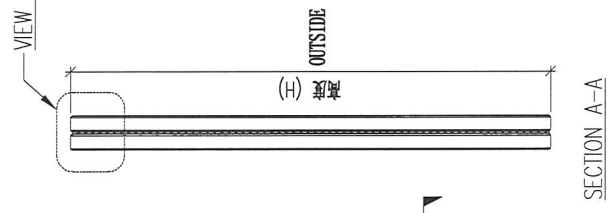
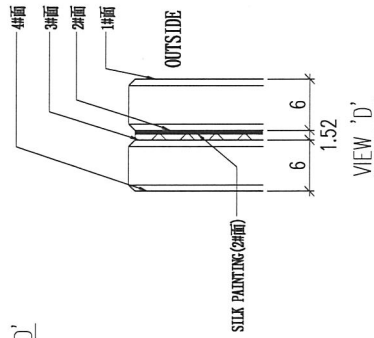
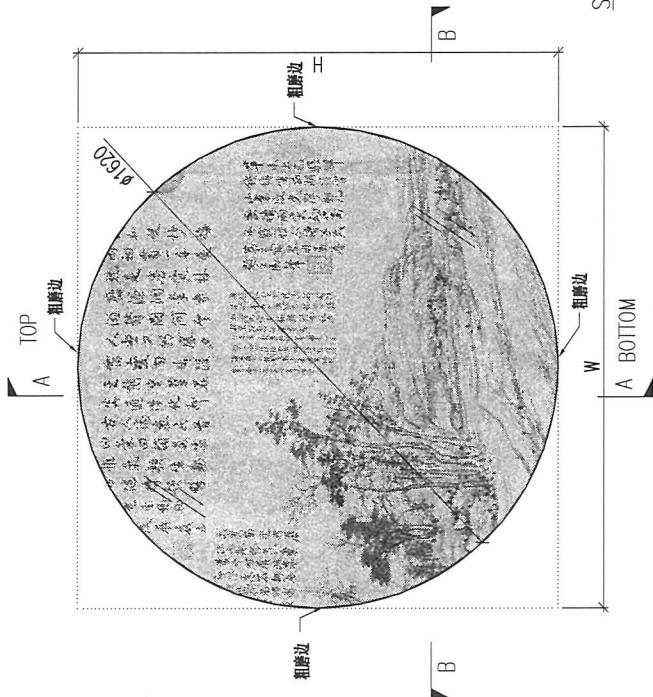

6mm±1.52PVB±6mm THK. LAMINATED TEMPERED GLASS

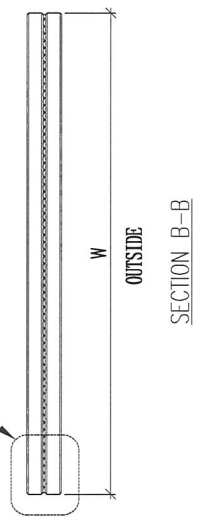

注:  
1、在左上角贴上编号

DWG. NO.	REV.	SCALE	DATE	DRAWN BY	APPROVED BY
G1-4017-4	-	-	03-07-2024	-	-

PROJECT: YIN PING ROAD KOWLOON FEATURE WALL (PHASE 2)

REV.	CHECKED BY	PART NUMBER	Dim. A	Dim. B	Dim. C	Dim. D	Dim. E	Dim. F	Dim. G	Dim. H	QTY.	Inv. Code	COATING	COLOUR	MARK. NO.	QTY.
-		G1-4017-5									1			ASSEMBLE ON PARTS	-	-

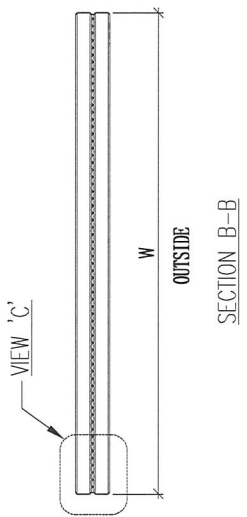
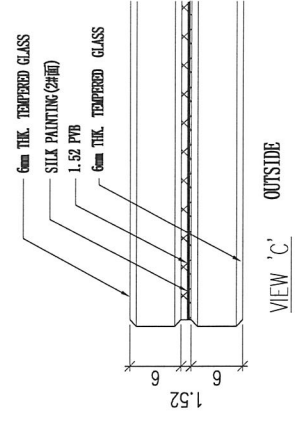
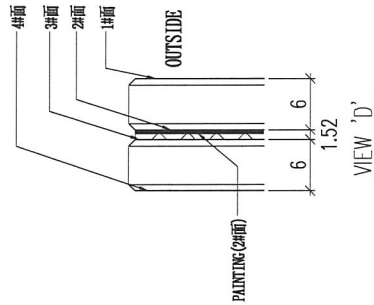
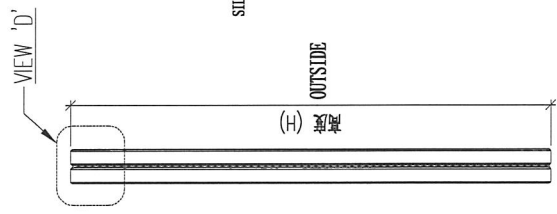
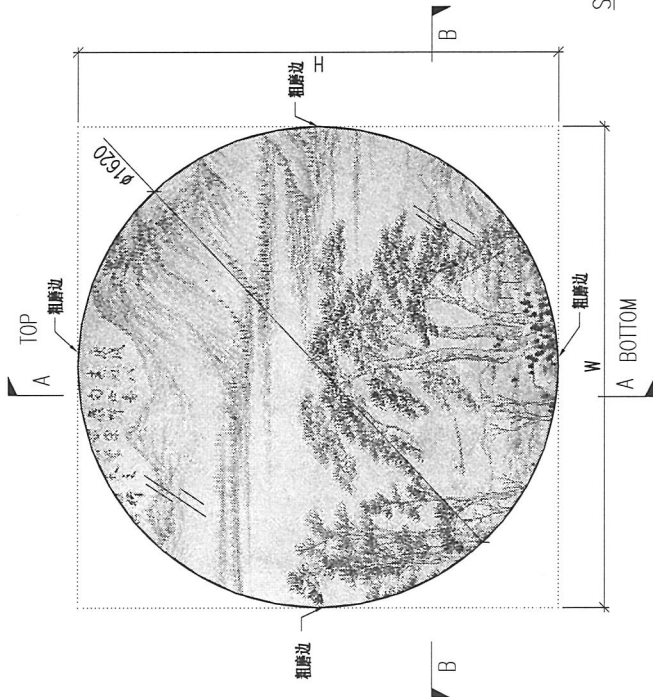

6mm THK. TEMPERED GLASS

注:  
1、在左上角贴上编号

DWG. NO.	REV.	SCALE	DATE	DRAWN BY	APPROVED BY
G1-4017-5	-	-	03-07-2024	-	-

PROJECT: YIN PING ROAD KOWLOON FEATURE WALL (PHASE 2)

REV.	CHANGED BY	Dim. A	Dim. B	Dim. C	Dim. D	Dim. E	Dim. F	Dim. G	Dim. H	QTY.	Inv. Code	COLOUR	MARK. NO.	QTY.
-										1		ASSEMBLE ON PARTS	-	-

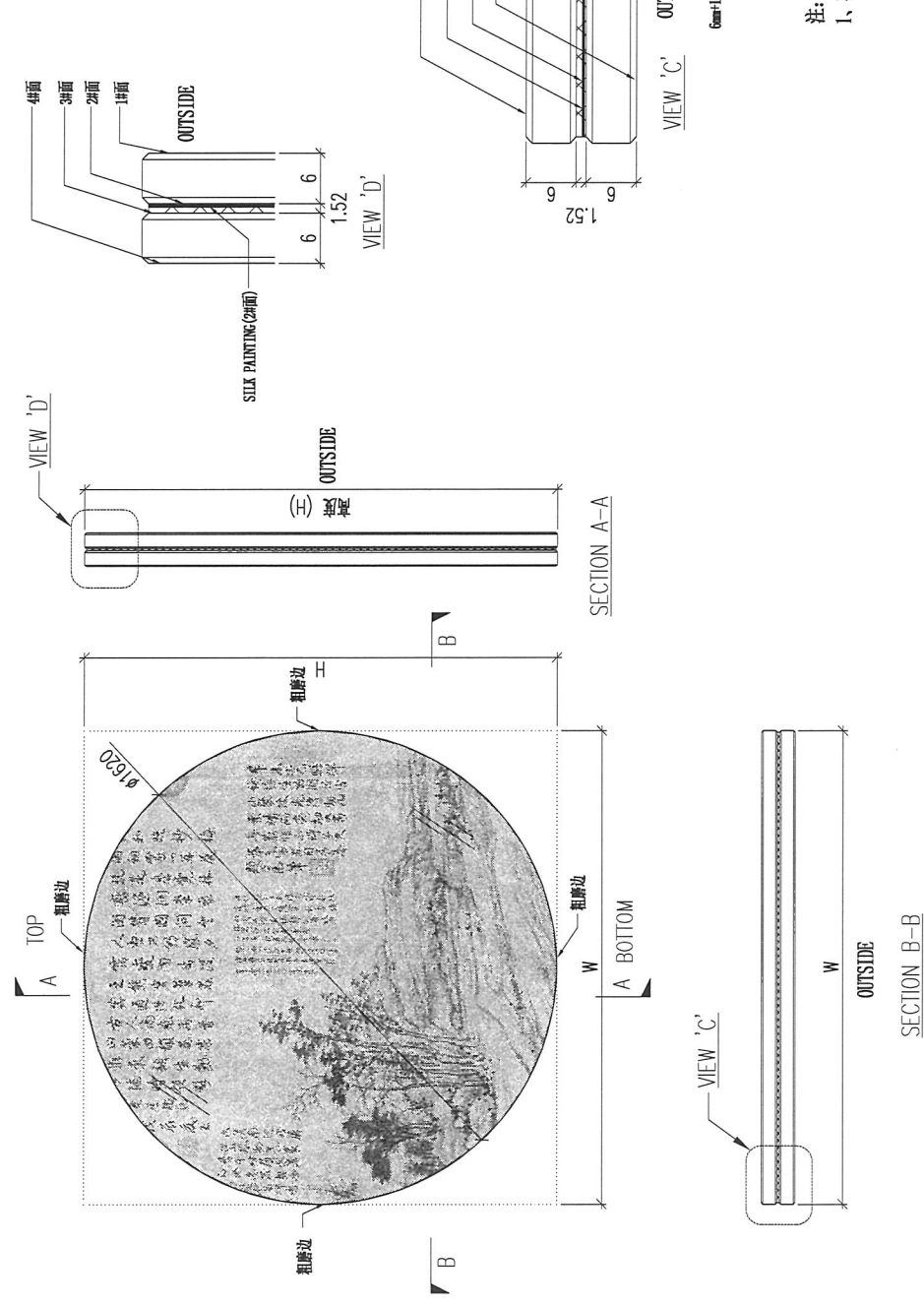

DWG. NO.	REV.	SCALE	DATE	DRAWN BY	APPROVED BY
G1-4017-6	-	-	03-07-2024	-	-

PROJECT: YIN PING ROAD KOWLOON FEATURE WALL (PHASE 2)

COLOUR: —

MARK. NO.: —

QTY.: —

REV.	CHECKED BY	PART NUMBER	Dim. A	Dim. B	Dim. C	Dim. D	Dim. E	Dim. F	Dim. G	Dim. H	QTY.	Inv. Code
—		G1-4018-7									1	

MATERIAL: GLASS WITH SILK PAINTING

COATING: —

ASSEMBLE ON PARTS

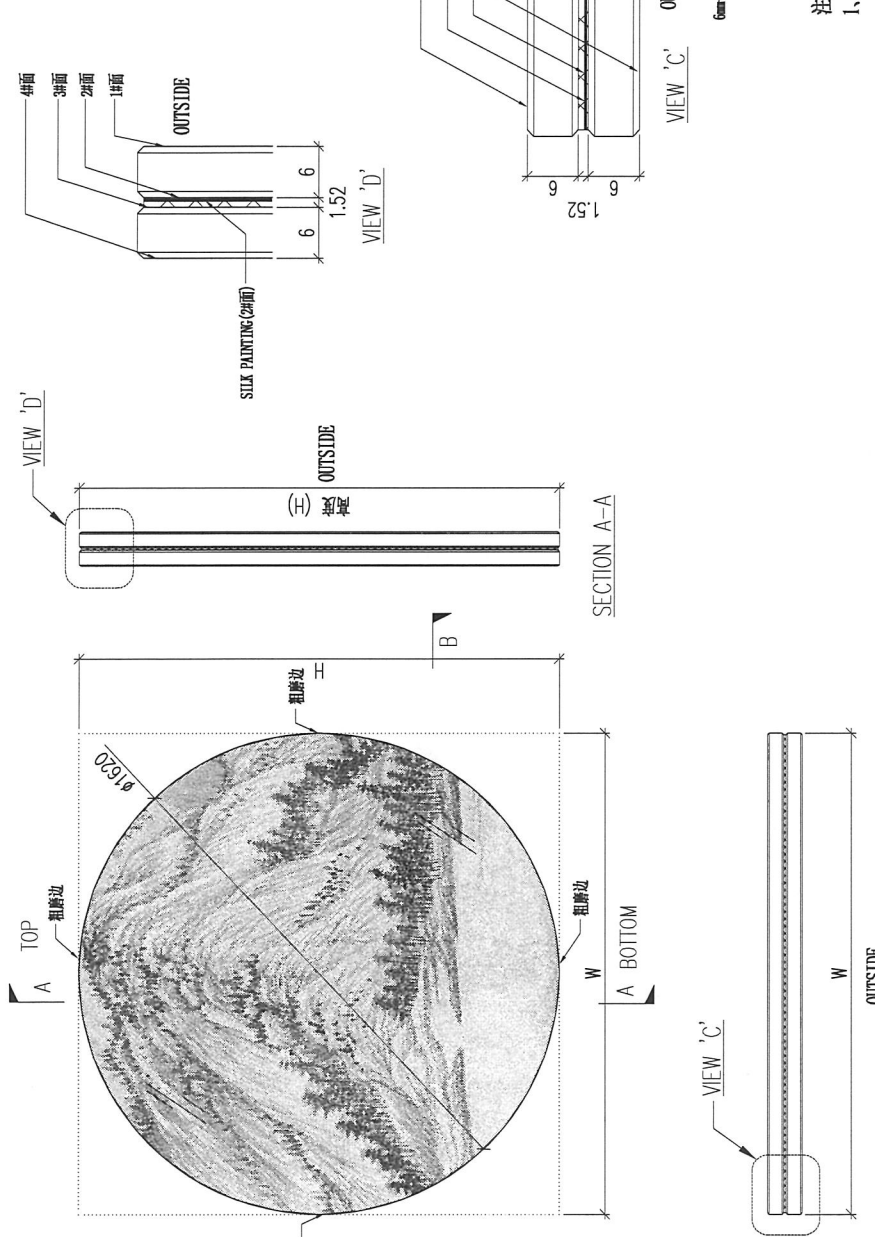

DWG. NO.	REV.	SCALE	DATE	DRAWN BY	APPROVED BY
G1-4018-7	—	—	03-07-2024	—	—

PROJECT: YIN PING ROAD KOWLOON FEATURE WALL (PHASE 2)

REV.	CHANGED BY/DT	PART NUMBER	Dim. A	Dim. B	Dim. C	Dim. D	Dim. E	Dim. F	Dim. G	Dim. H	QTY.	Inv. Code	COATING	COLOUR	MARK. NO.	QTY.
-		G1-4018-8									1					

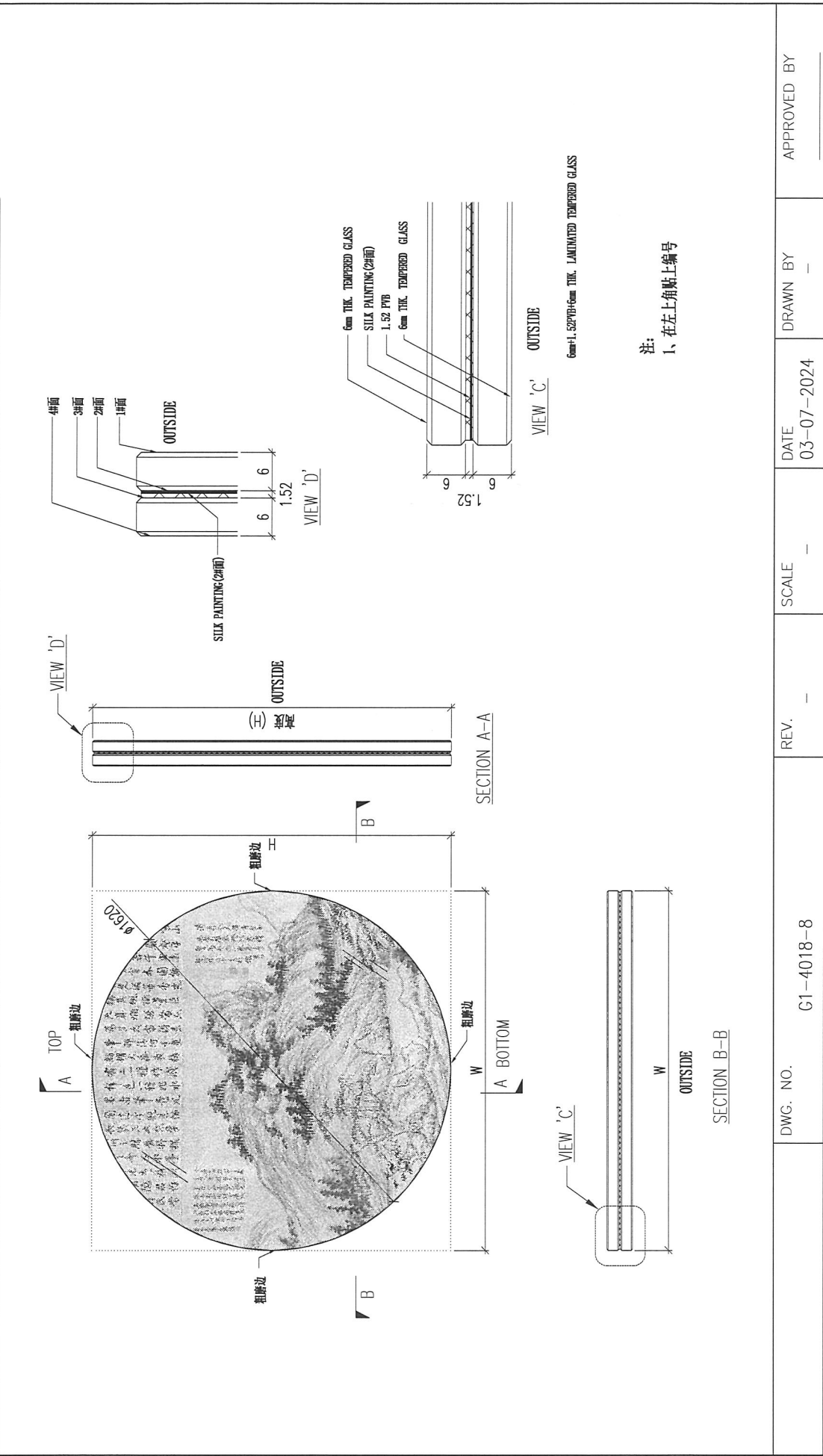

PROJECT: YIN PING ROAD KOWLOON FEATURE WALL (PHASE 2)

REV.	CHANGED BY/DT	PART NUMBER	Dim. A	Dim. B	Dim. C	Dim. D	Dim. E	Dim. F	Dim. G	Dim. H	QTY.	Inv. Code	COLOUR	MARK. NO.	QTY.
-		G1-4018-9									1		ASSEMBLE ON PARTS	-	-

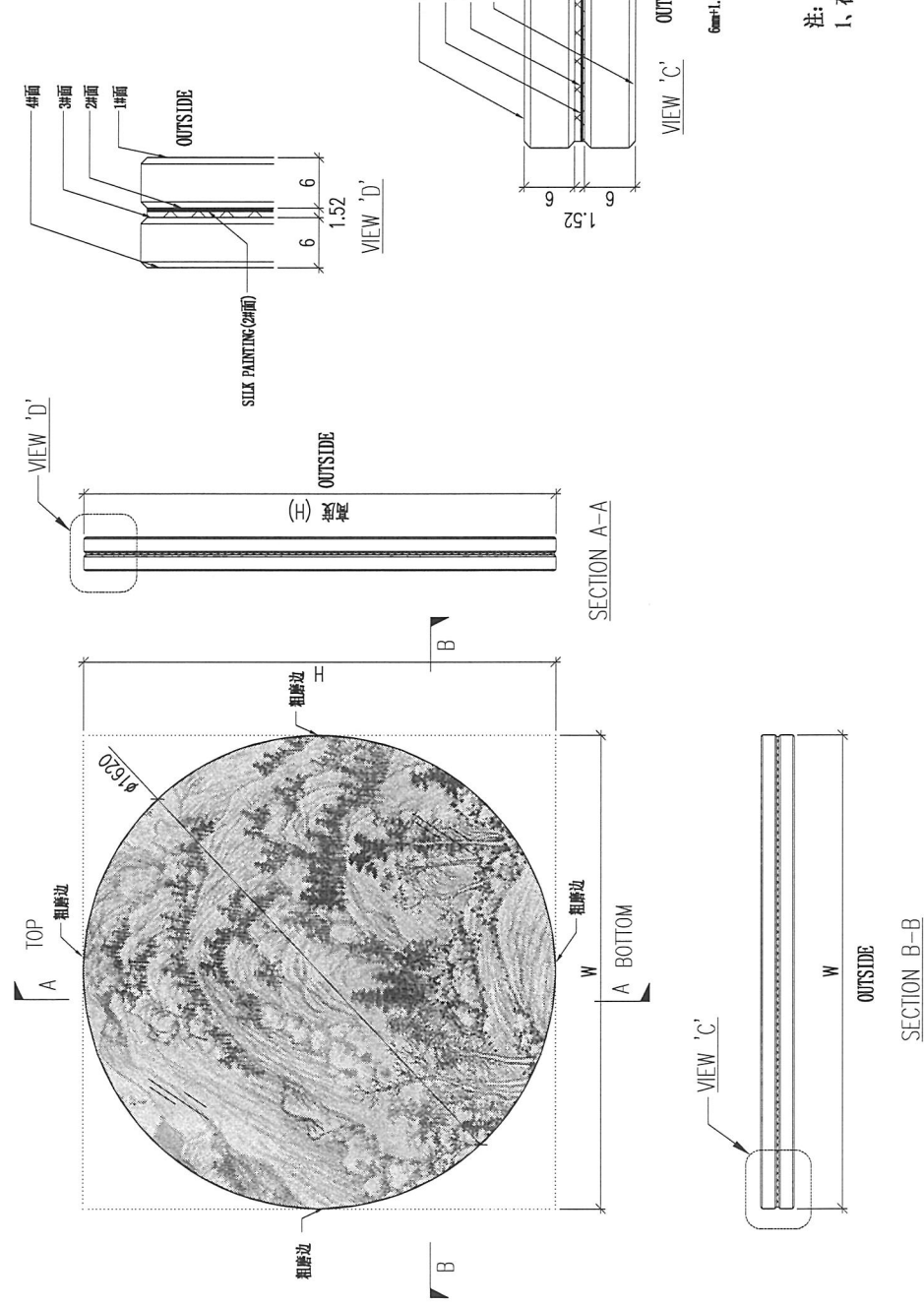

注:  
1、在左上角贴上编号

DWG. NO.	G1-4018-9	REV.	-	SCALE	-	DATE	03-07-2024	DRAWN BY	-	APPROVED BY	-
----------	-----------	------	---	-------	---	------	------------	----------	---	-------------	---

PROJECT: YIN PING ROAD KOWLOON FEATURE WALL (PHASE 2)

REV.	CHECKED BY	PART NUMBER	Dim. A	Dim. B	Dim. C	Dim. D	Dim. E	Dim. F	Dim. G	Dim. H	QTY.	Inv. Code	COLOUR	MARK. NO.	QTY.
-		G1-4018-10									1		ASSEMBLE ON PARTS	-	-

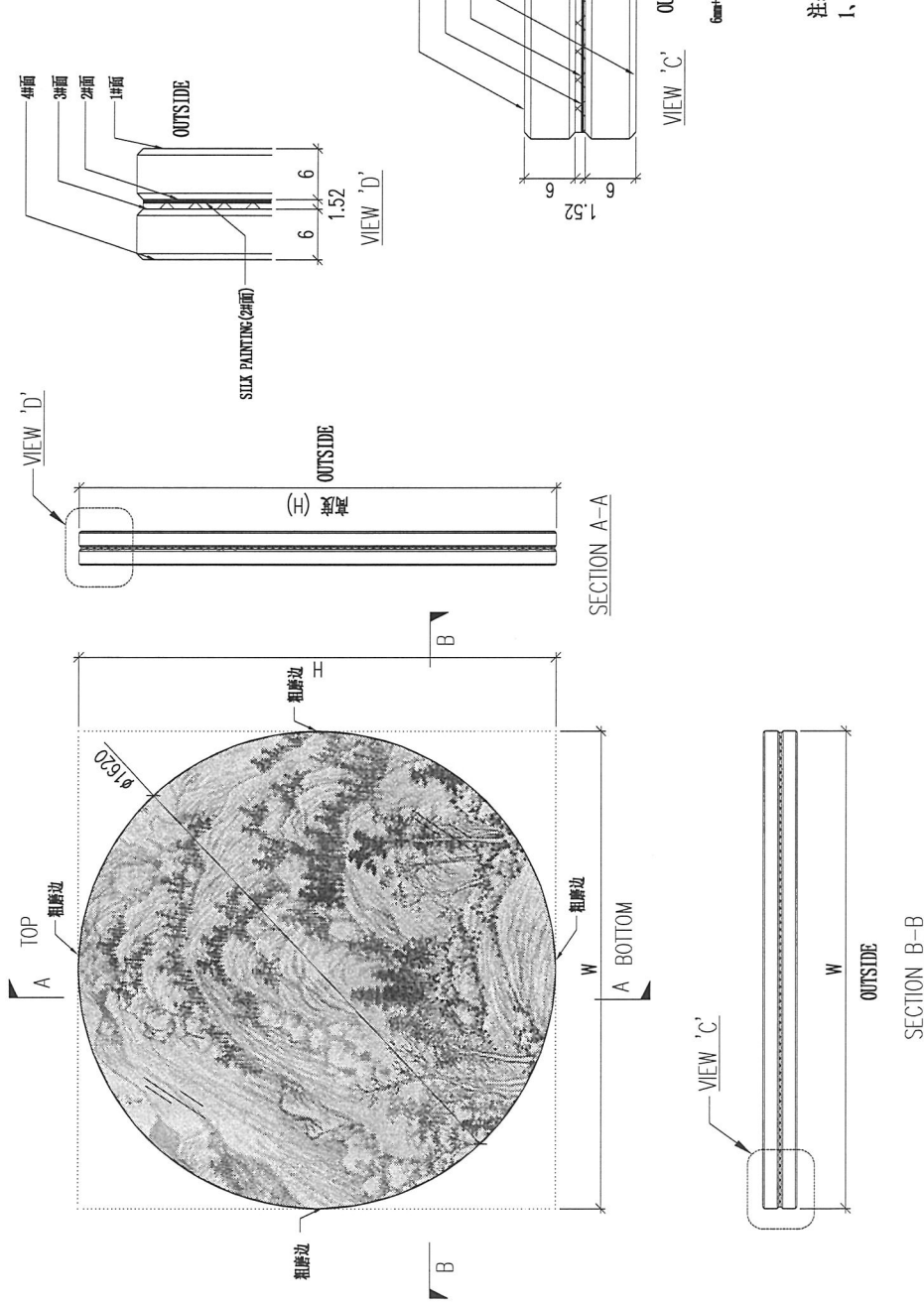

注:  
1、在左上角贴上编号

DWG. NO.	C1-4018-10	REV.	-	SCALE	-	DATE	03-07-2024	DRAWN BY	-	APPROVED BY	-
----------	------------	------	---	-------	---	------	------------	----------	---	-------------	---

PROJECT YIN PING ROAD KOWLOON FEATURE WALL (PHASE 2)

REV.	CHECKED DATE BY	PART NUMBER	Dim. A	Dim. B	Dim. C	Dim. D	Dim. E	Dim. F	Dim. G	Dim. H	QTY.	Inv. Code	COATING	MATERIAL GLASS WITH SILK PAINTING	COLOUR	MARK. NO.	QTY.
-		G1-4018-11									1			ASSEMBLE ON PARTS			

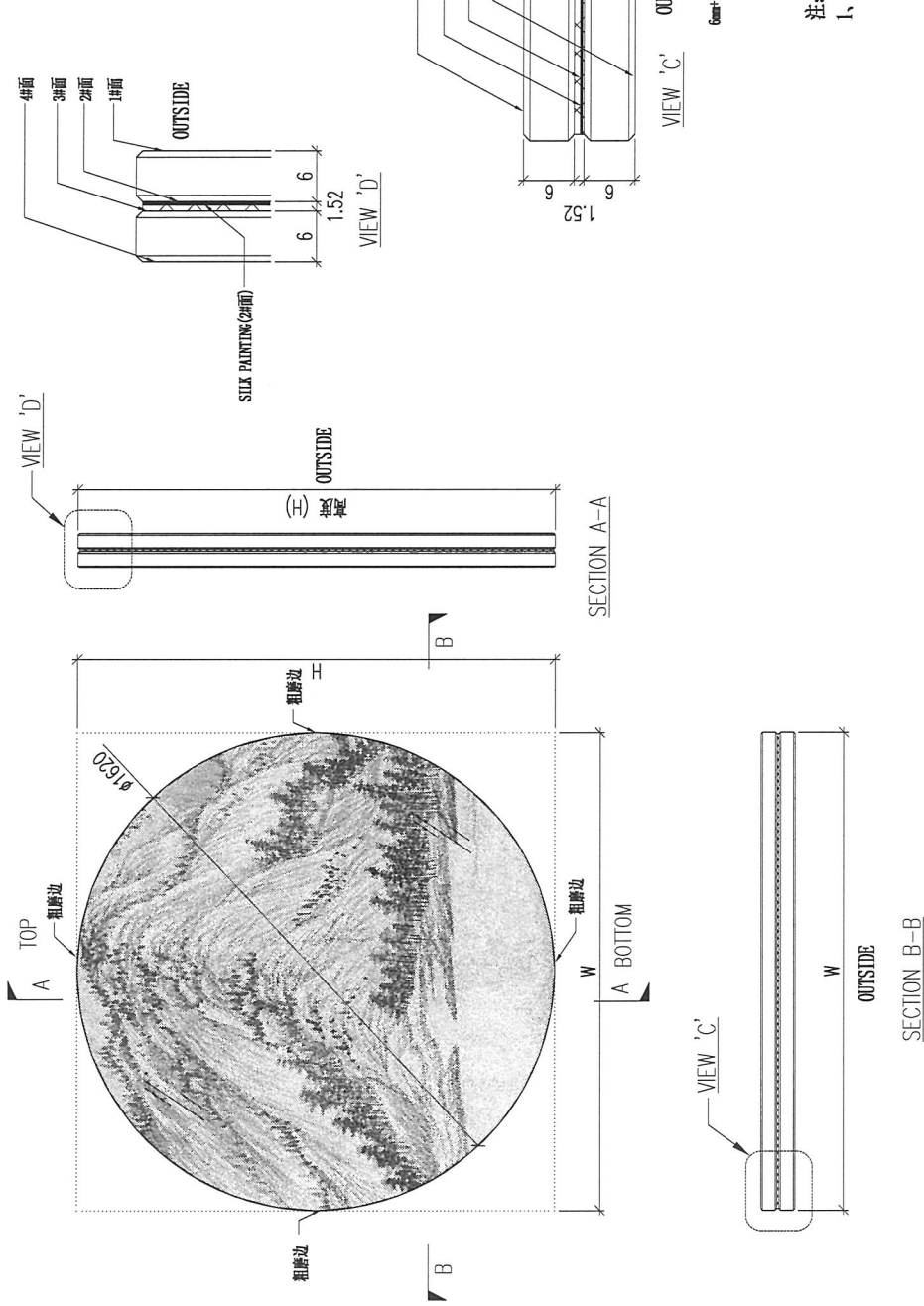

注：  
1、在左上角贴上编号

DWG. NO.	C1-4018-11	REV.	-	SCALE	-	DATE	03-07-2024	DRAWN BY	-	APPROVED BY	-
----------	------------	------	---	-------	---	------	------------	----------	---	-------------	---

PROJECT: YIN PING ROAD KOWLOON FEATURE WALL (PHASE 2)

REV.	CHANGED BY/DT	PART NUMBER	Dim. A	Dim. B	Dim. C	Dim. D	Dim. E	Dim. F	Dim. G	Dim. H	QTY.	Inv. Code	COLOUR	MARK. NO.	QTY.
-		G1-4018-12									1		ASSEMBLE ON PARTS	-	-

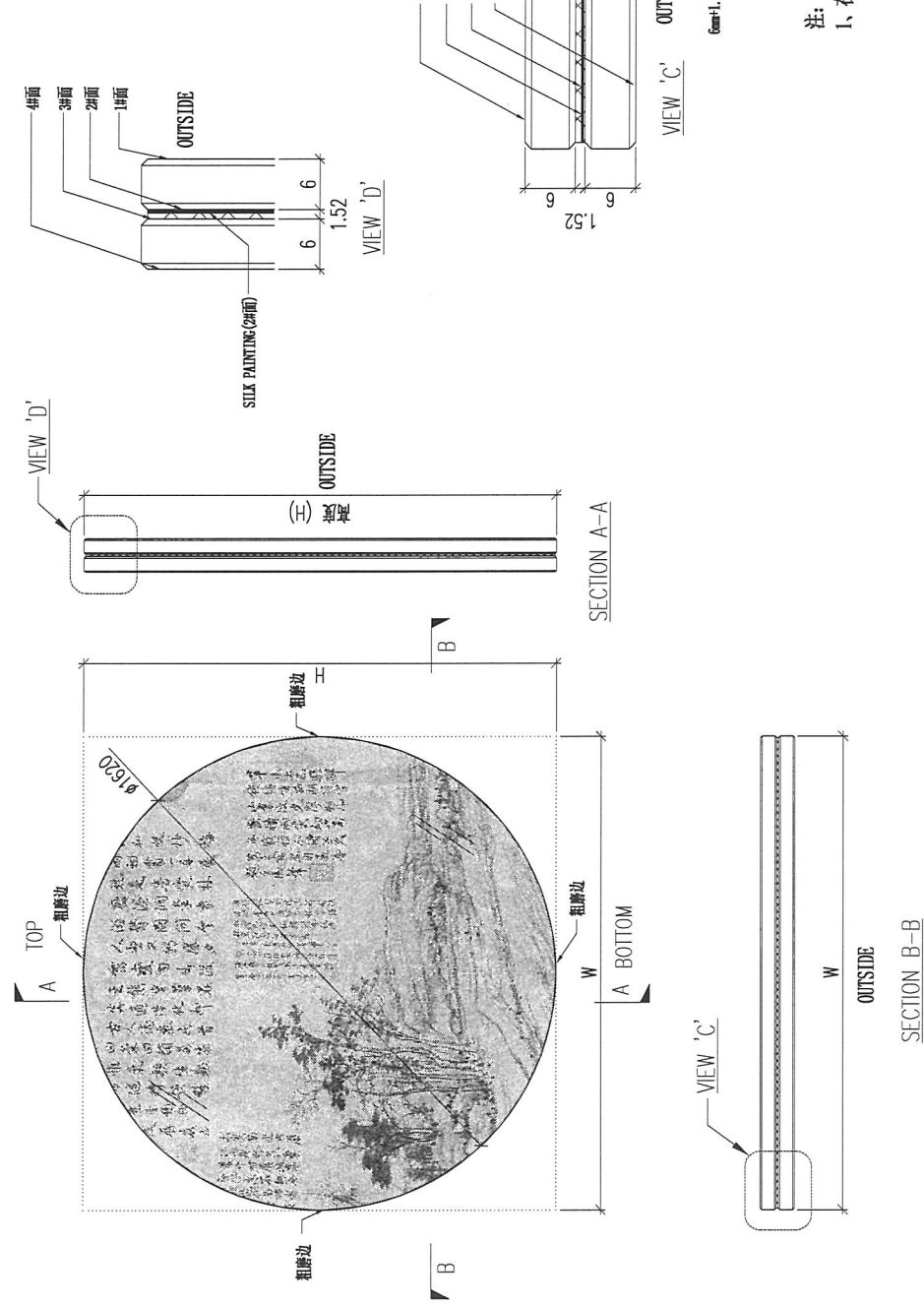

注:  
1、在左上角贴上编号

DWG. NO.	C1-4018-12	REV.	-	SCALE	-	DATE	03-07-2024	DRAWN BY	-	APPROVED BY	-
----------	------------	------	---	-------	---	------	------------	----------	---	-------------	---

PROJECT: YIN PING ROAD KOWLOON FEATURE WALL (PHASE 2)

REV.	CHECKED BY	PART NUMBER	Dim. A	Dim. B	Dim. C	Dim. D	Dim. E	Dim. F	Dim. G	Dim. H	QTY.	Inv. Code	COATING	COLOR	MARK. NO.	QTY.
-		G1-4019-13									1					

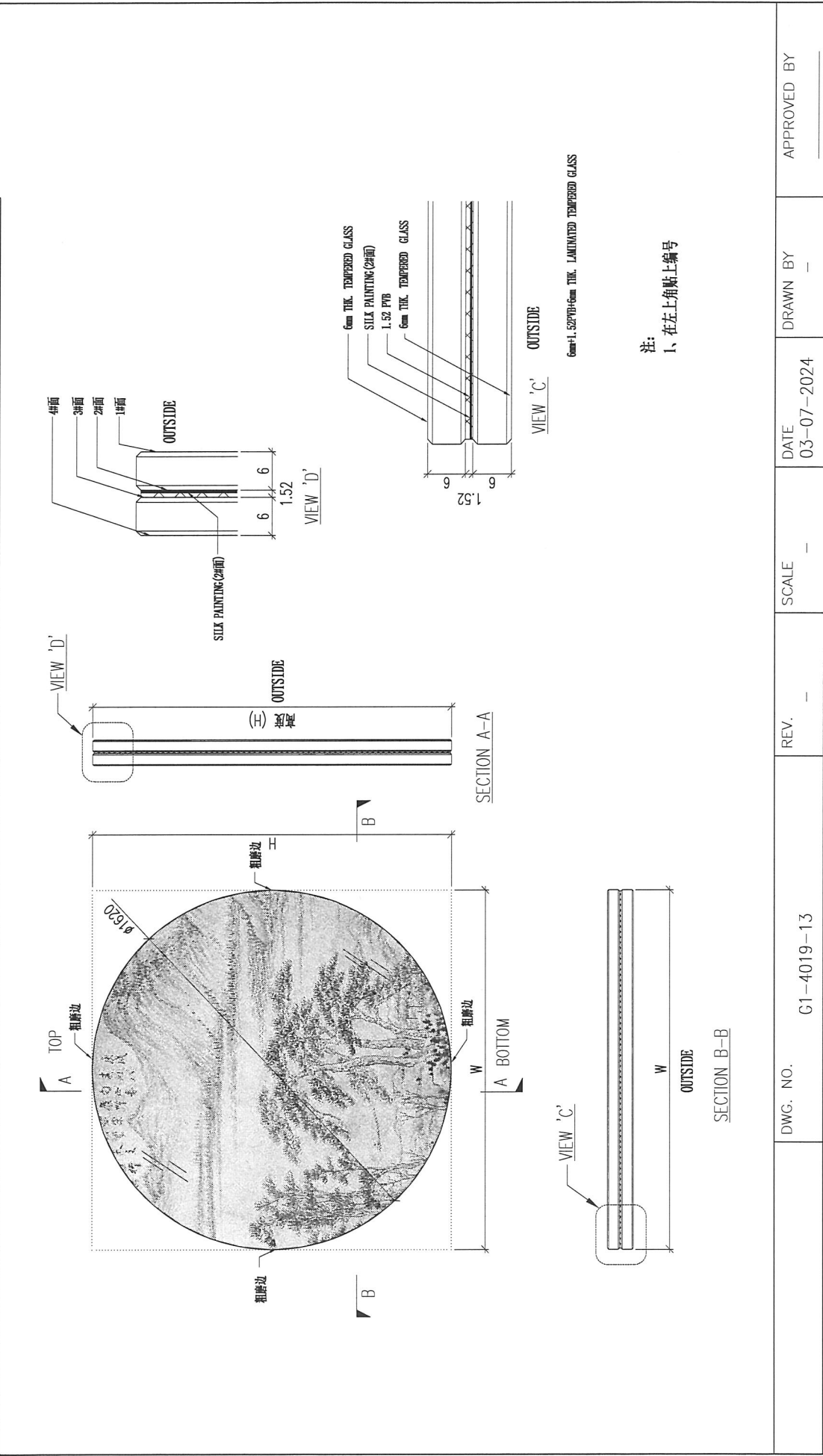

DWG. NO.	G1-4019-13	REV.	-	SCALE	-	DATE	03-07-2024	DRAWN BY	-	APPROVED BY	-
----------	------------	------	---	-------	---	------	------------	----------	---	-------------	---

PROJECT: YIN PING ROAD KOWLOON FEATURE WALL (PHASE 2)

REV.	CHECKED BY/DT	PART NUMBER	Dim. A	Dim. B	Dim. C	Dim. D	Dim. E	Dim. F	Dim. G	Dim. H	QTY.	Inv. Code	COATING	COLOR	MARK. NO.	QTY.
-		G1-4019-14									1					

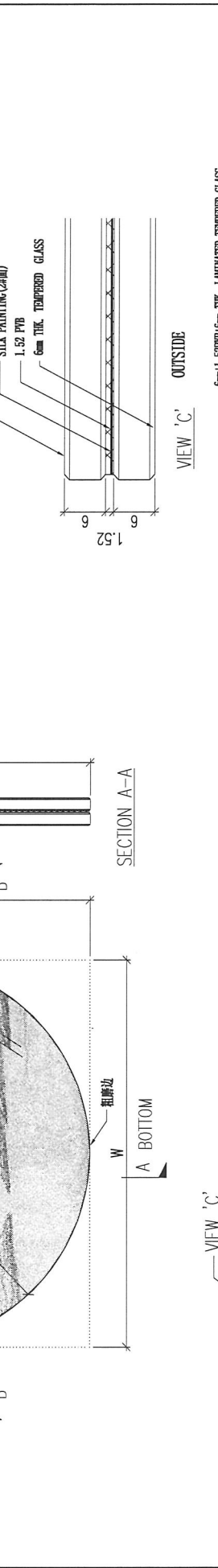
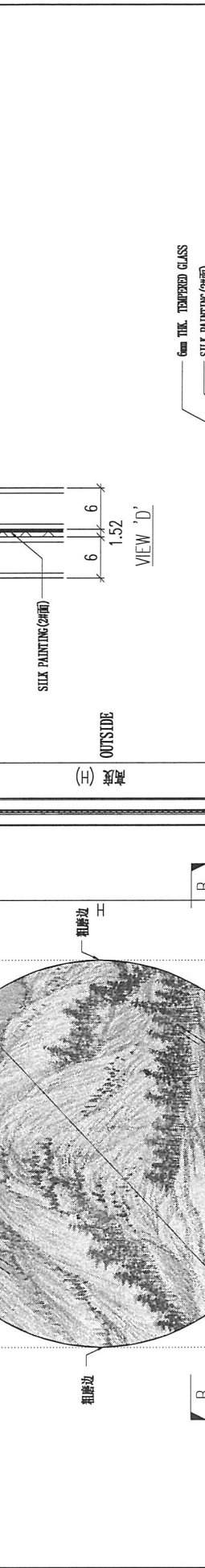
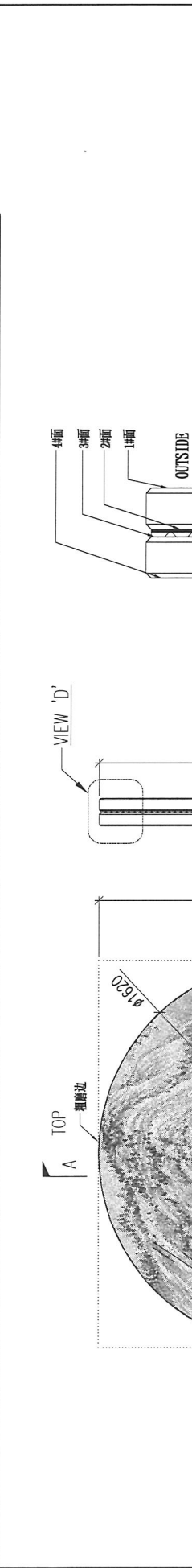

6mm THK. TEMPERED GLASS  
SILK PAINTING (彩面)  
1.52 PFB  
6mm THK. TEMPERED GLASS

6mm+1.52PFB+6mm THK. LAMINATED TEMPERED GLASS

注:  
1、在左上角贴上编号

DWG. NO.	G1-4019-14	REV.	-	SCALE	-	DATE	03-07-2024	DRAWN BY	-	APPROVED BY	-
----------	------------	------	---	-------	---	------	------------	----------	---	-------------	---

PROJECT: YIN PING ROAD KOWLOON FEATURE WALL (PHASE 2)

REV.	CHECKED DATE	PART NUMBER	Dim. A	Dim. B	Dim. C	Dim. D	Dim. E	Dim. F	Dim. G	Dim. H	QTY.	Inv. Code	COATING	COLOR	MARK. NO.	QTY.
-		G1-4019-15									1					

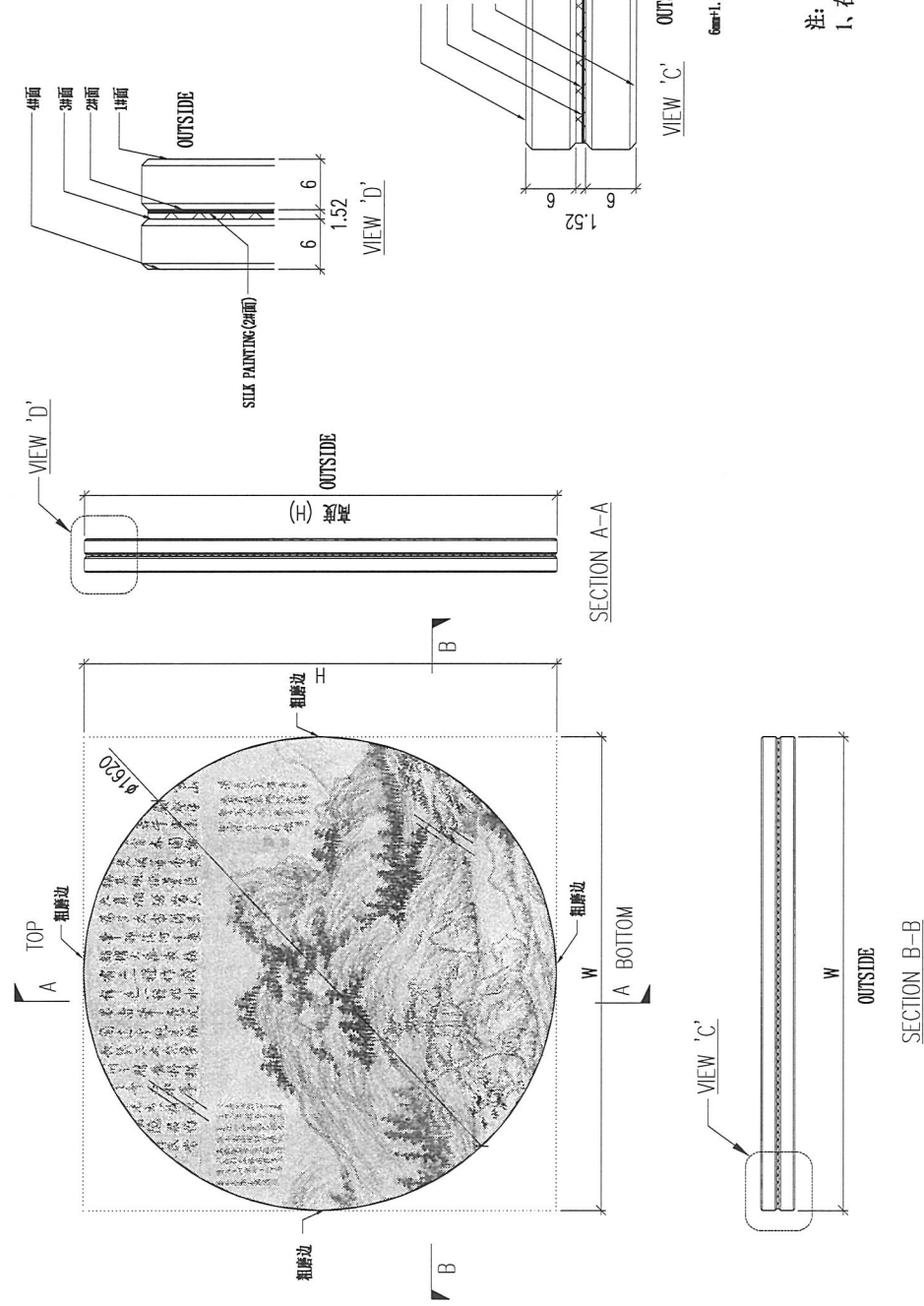

注: 1、在左上角贴上编号

DWG. NO.	C1-4019-15	REV.	-	SCALE	-	DATE	03-07-2024	DRAWN BY	-	APPROVED BY	-
----------	------------	------	---	-------	---	------	------------	----------	---	-------------	---

PROJECT: YIN PING ROAD KOWLOON FEATURE WALL (PHASE 2)

REV.	CHECKED BY	PART NUMBER	Dim. A	Dim. B	Dim. C	Dim. D	Dim. E	Dim. F	Dim. G	Dim. H	QTY.	Inv. Code	COATING	MATERIAL	GLASS WITH SILK PAINTING	COLOUR	MARK. NO.	QTY.
-		G1-4019-16									1			GLASS WITH SILK PAINTING	ASSEMBLE ON PARTS			

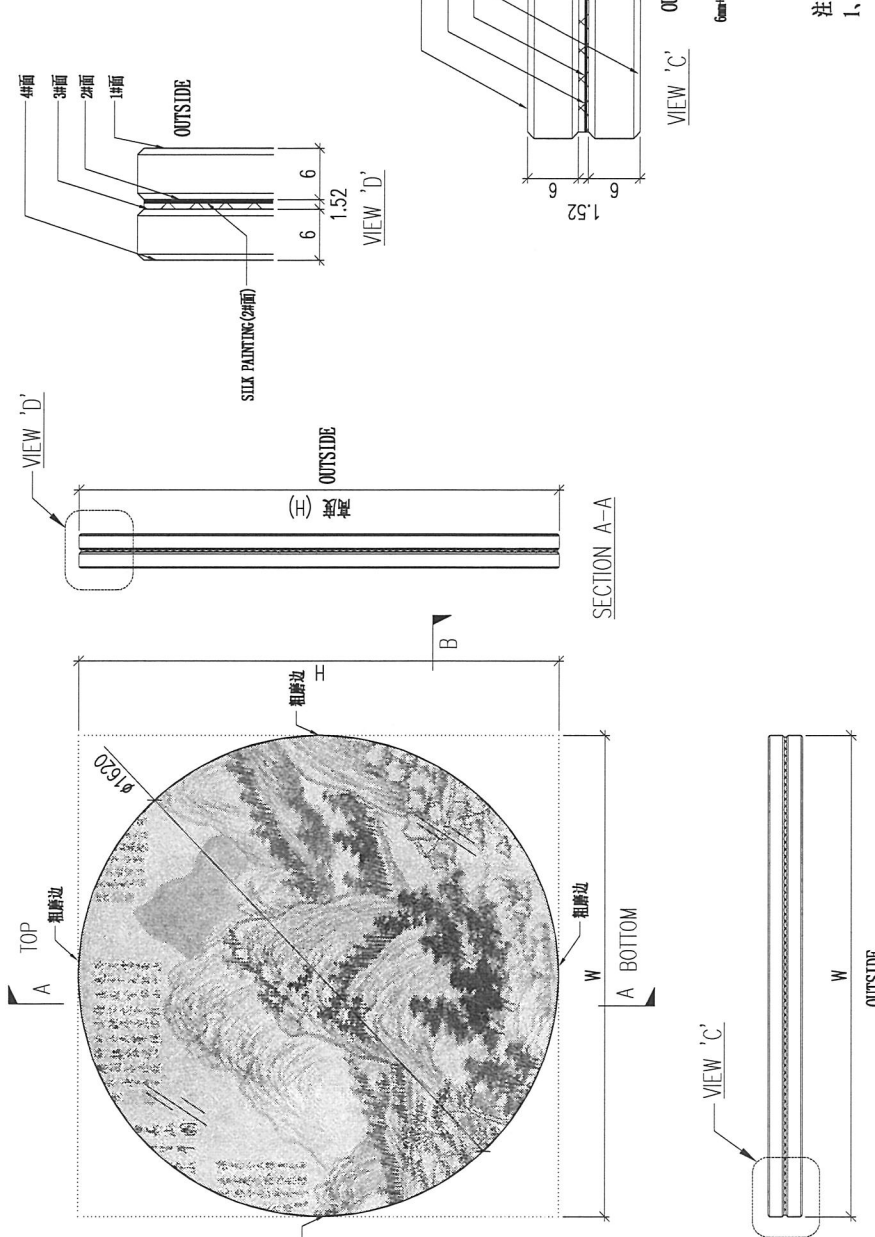

注:  
1、在左上角贴上编号

DWG. NO.	G1-4019-16	REV.	-	SCALE	-	DATE	03-07-2024	DRAWN BY	-	APPROVED BY	-
----------	------------	------	---	-------	---	------	------------	----------	---	-------------	---

PROJECT: YIN PING ROAD KOWLOON FEATURE WALL (PHASE 2)

REV.	CHECKED DATE	Dim. A	Dim. B	Dim. C	Dim. D	Dim. E	Dim. F	Dim. G	Dim. H	QTY.	Inv. Code	COATING	COLOUR	MARK. NO.	QTY.
-										1					

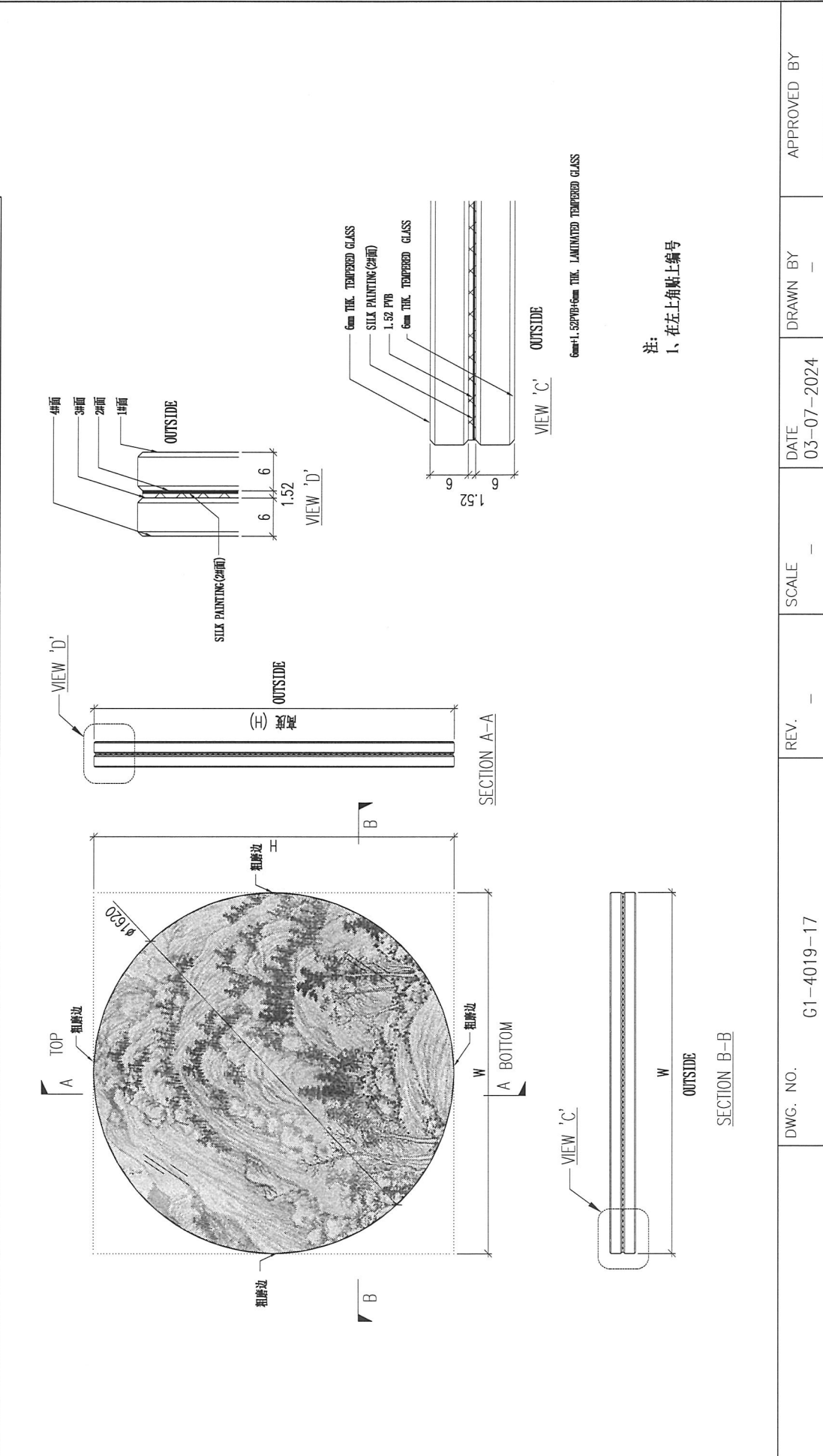

DWG. NO.	G1-4019-17	REV.	-	SCALE	-	DATE	03-07-2024	DRAWN BY	-	APPROVED BY	-
----------	------------	------	---	-------	---	------	------------	----------	---	-------------	---

PROJECT: YIN PING ROAD KOWLOON FEATURE WALL (PHASE 2)

REV.	CHECKED BY	PART NUMBER	Dim. A	Dim. B	Dim. C	Dim. D	Dim. E	Dim. F	Dim. G	Dim. H	QTY.	Inv. Code	COATING	COLOUR	MARK. NO.	QTY.
-		G1-4019-18									1					

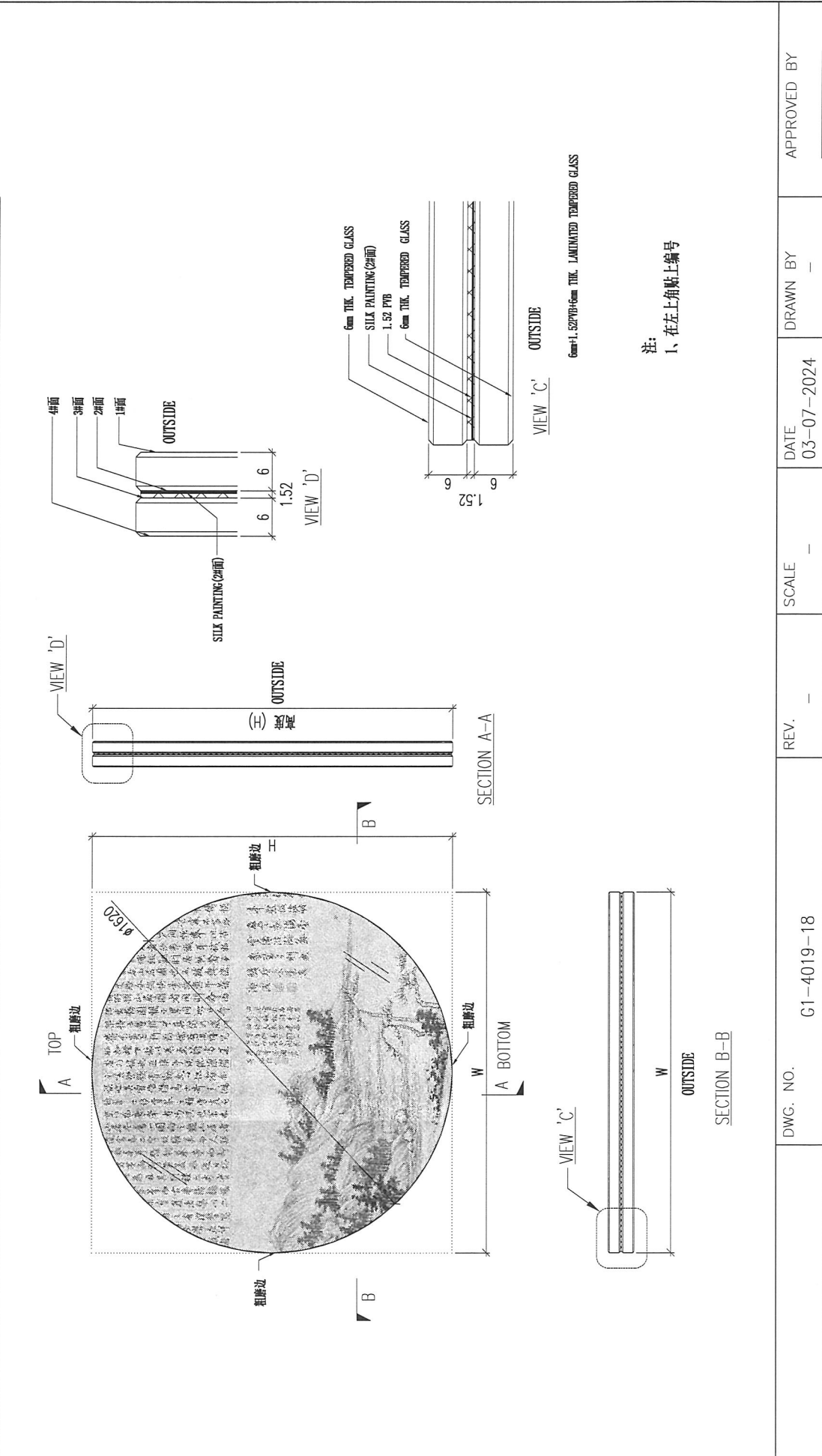

DWG. NO.	G1-4019-18	REV.	-	SCALE	-	DATE	03-07-2024	DRAWN BY	-	APPROVED BY	-
----------	------------	------	---	-------	---	------	------------	----------	---	-------------	---