



工程指示 / 要求簡箋 ENGINEER INSTRUCTIONS(E.I.)

工程指示編號:	EI- 8024 A	修改版本:	- A
	HK- 1406		
工程編號:	J 853	工程名稱:	延坪道 (第2期)
收件人:	生統/	發件人:	Jingo
工程項目:	Feature wall 飾線 鋁板加工圖地盤用 修改 Part 5	日期:	1/8/2024

<input type="checkbox"/> 原合約工程包	<input type="checkbox"/> 原合約工程加 / 減脹 QT-	<input type="checkbox"/> 新工程報價 QT-
---------------------------------	--	------------------------------------

信件批核號碼/圖紙參考編號:	批核模具圖紙編號:
客戶指示附件:	管理內部批簽署:

<input type="checkbox"/> 初步鋁料 B.M.	<input type="checkbox"/> 加工拆圖, 然後生產	<input type="checkbox"/> 尺寸表
<input type="checkbox"/> 正式鋁料 B.M.	<input type="checkbox"/> 技術上資料/指示	<input type="checkbox"/> 報價
<input type="checkbox"/> 配件 B.M.	<input type="checkbox"/> 樣辦或貨品說明書	<input type="checkbox"/> 分判合約
<input type="checkbox"/> 其他:		

內容: 按修改圖紙加工

按孤位圖包裝

完成上列要求日期: 2/8/2024

國內

<input type="checkbox"/> 生產技術總監	<input type="checkbox"/> 連附件	<input type="checkbox"/> 技術部	<input type="checkbox"/> 連附件	<input type="checkbox"/> 生產部	<input type="checkbox"/> 連附件
<input type="checkbox"/> 採購部	<input type="checkbox"/> 連附件	<input checked="" type="checkbox"/> 生產統籌部	<input checked="" type="checkbox"/> 連附件	<input type="checkbox"/> 報關組	<input type="checkbox"/> 連附件
<input type="checkbox"/> 質檢部	<input type="checkbox"/> 連附件	<input type="checkbox"/> 會計部	<input type="checkbox"/> 連附件	<input type="checkbox"/> 機械設計部	<input type="checkbox"/> 連附件
<input type="checkbox"/> 香港辦	<input type="checkbox"/> 連附件	<input type="checkbox"/> 其他:			

香港

<input type="checkbox"/> 行政部	<input type="checkbox"/> 連附件	<input type="checkbox"/> 會計部	<input type="checkbox"/> 連附件	<input type="checkbox"/> 統籌部	<input type="checkbox"/> 連附件	<input type="checkbox"/> 工程部	<input type="checkbox"/> 連附件
<input type="checkbox"/> 採購部	<input type="checkbox"/> 連附件	<input type="checkbox"/> QS部	<input type="checkbox"/> 連附件	<input checked="" type="checkbox"/> 地盤管理	<input checked="" type="checkbox"/> 連附件	<input type="checkbox"/> 維修部	<input type="checkbox"/> 連附件

*發件人簽署:	*組別成員批核簽署:
傳遞編號:	項目經理簽署:

PROJECT				MATERIAL				COATING				COLOUR		MARK. NO.		QTY.	
YIN PING ROAD KOWLOON FEATURE WALL (PHASE 2)				3mm鋁板				PVF2				EC-DG-D334232-ZD1(SS-01)		-		-	
REV.	CHECKED	PART NUMBER	Dim. A	Dim. B	Dim. C	Dim. D	Dim. E	Dim. F	Dim. G	Dim. H	QTY.	Inv. Code	ASSEMBLE ON PARTS				
-	FW-1101	-	-	-	-	-	-	-	-	-	2	-	注：用于B区域				
												地盤用		用A3紙打印			

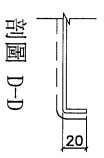
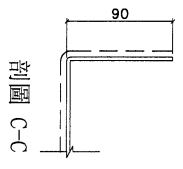
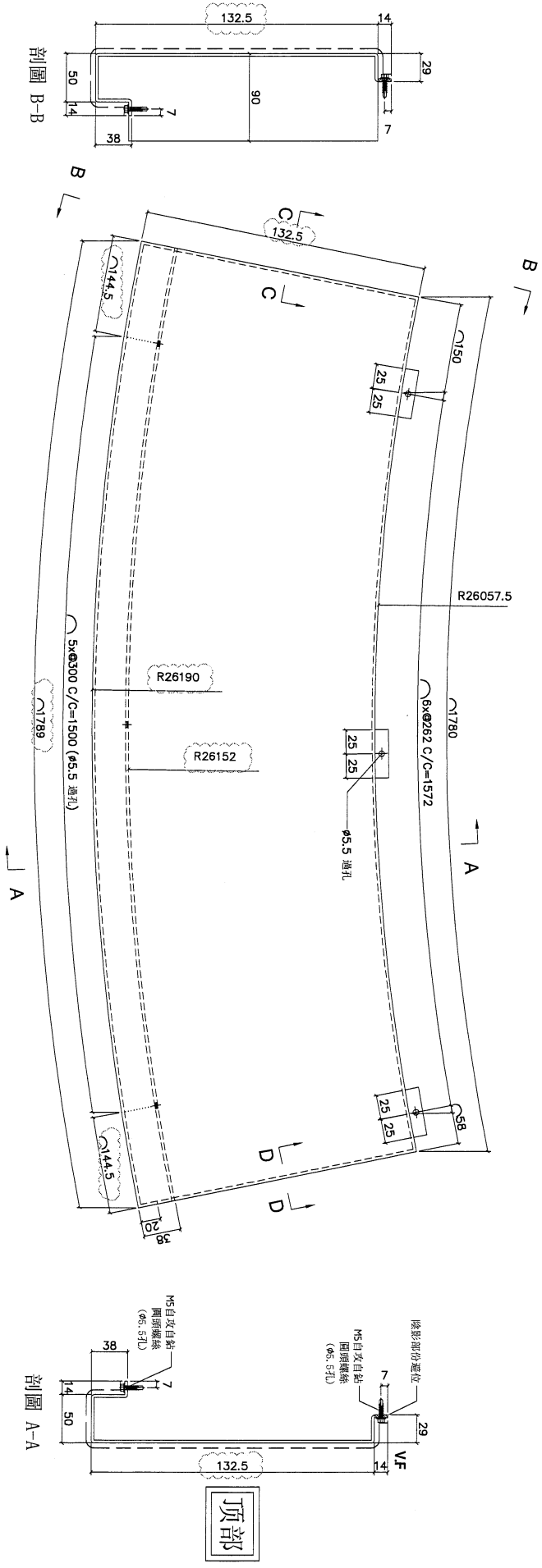

DWG. NO.		REV.		SCALE		DATE		DRAWN BY		APPROVED BY	
FW-1101		A		-		06-07-2024		-		-	

PROJECT
YIN PING ROAD KOWLOON
FEATURE WALL (PHASE 2)

MATERIAL
3mm 铝板

COATING
PVF2

COLOUR
EC-DG-D34232-ZD1(SS-01)

MARK. NO.
-

QTY.
-

REV. / 更改	PART NUMBER	Dim. A	Dim. B	Dim. C	Dim. D	Dim. E	Dim. F	Dim. G	Dim. H	QTY.	Inv. Code	ASSEMBLE ON PARTS
-	FW-T102	-	-	-	-	-	-	-	-	4	-	注：用于 B 区域

地盘用

用A3纸打印

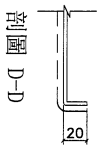
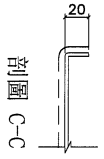
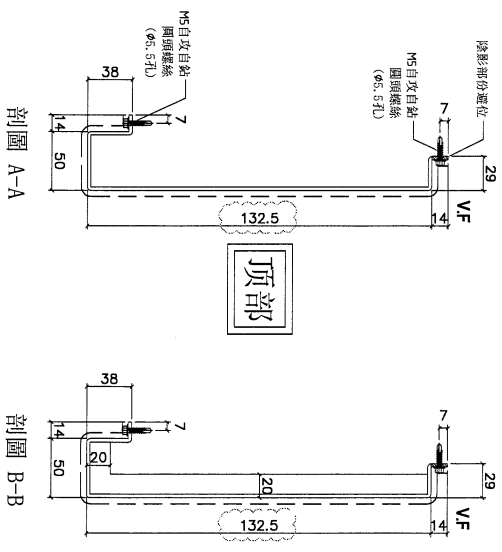
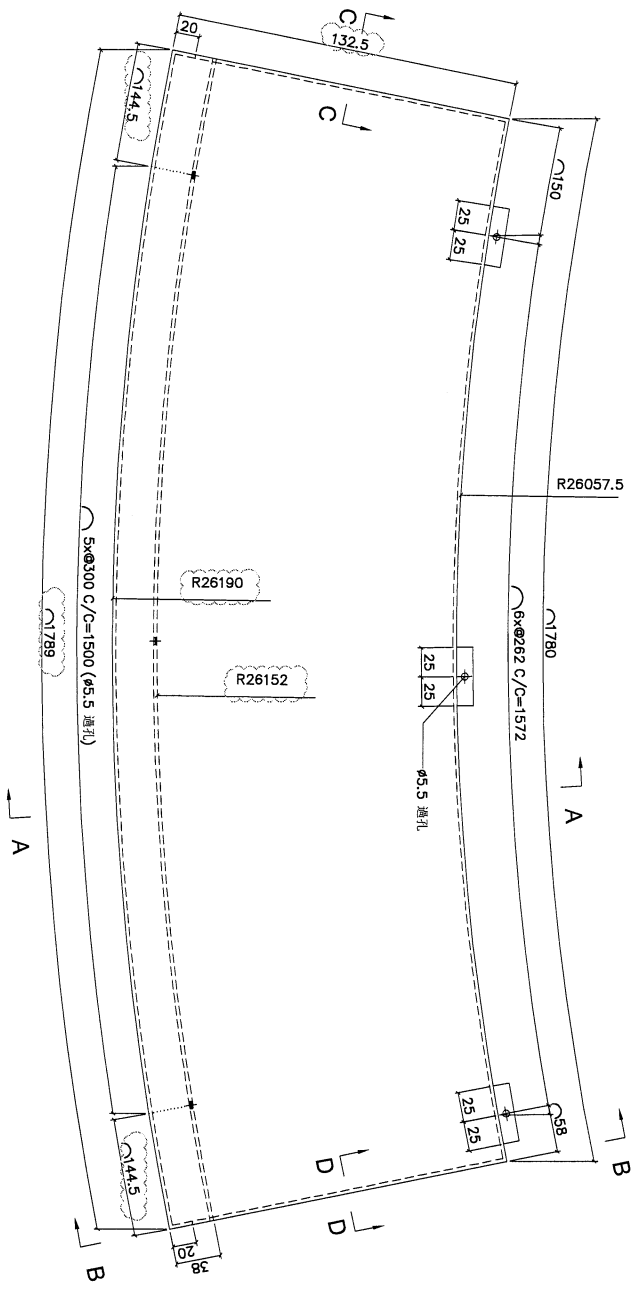

DWG. NO.	FW-T102	REV.	A	SCALE	-	DATE	06-07-2024	DRAWN BY	-	APPROVED BY	-
----------	---------	------	---	-------	---	------	------------	----------	---	-------------	---

PROJECT
YIN PING ROAD KOWLOON
FEATURE WALL (PHASE 2)

MATERIAL
3mm铝板

COATING
PVF2

COLOUR
EC-DG-D334232-ZD1(SS-01)

MARK. NO.
-

QTY.
-

REV.	CHANGED BY	PART NUMBER	Dim. A	Dim. B	Dim. C	Dim. D	Dim. E	Dim. F	Dim. G	Dim. H	QTY.	Inv. Code	ASSEMBLE ON PARTS
-		FW-1103	-	-	-	-	-	-	-	-	1		注：用于B区域

地盤用

用A3紙打印

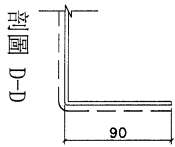
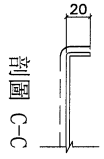
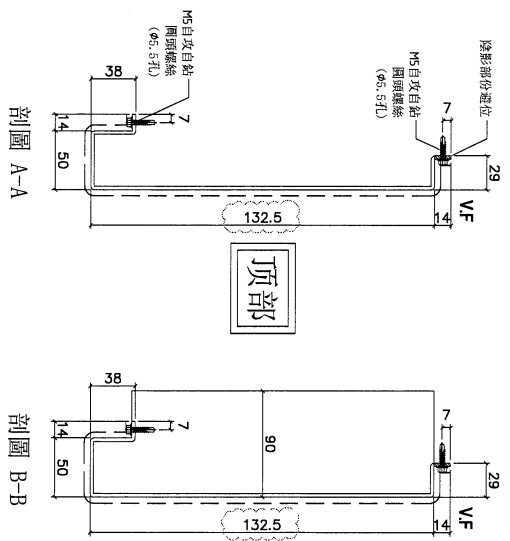
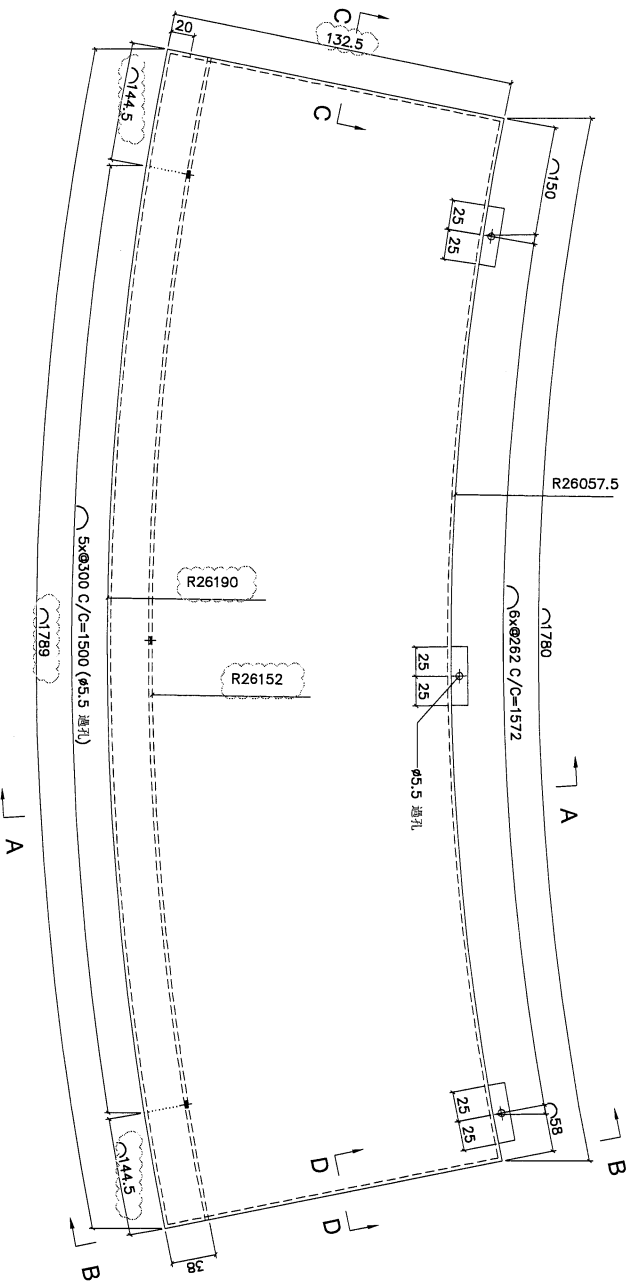

DWG. NO.	FW-1103	REV.	A	SCALE	-	DATE	06-07-2024	DRAWN BY	-	APPROVED BY	-
----------	---------	------	---	-------	---	------	------------	----------	---	-------------	---

PROJECT
YIN PING ROAD KOWLOON
FEATURE WALL (PHASE 2)

MATERIAL
3mm 铝板

COATING
PVF2

COLOUR
EC-DG-D334232-ZD1 (SS-01)

MARK. NO.
-

QTY.
-

REV. / CHECKED BY	PART NUMBER	Dim. A	Dim. B	Dim. C	Dim. D	Dim. E	Dim. F	Dim. G	Dim. H	QTY.	Inv. Code
-	FW-T104	-	-	-	-	-	-	-	-	9	-

ASSEMBLE ON PARTS
注：用于 B 区域

地盘用

用A3纸打印

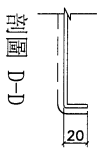
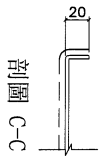
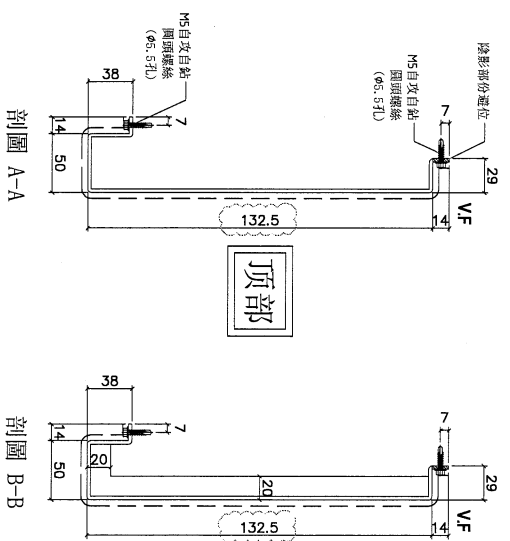
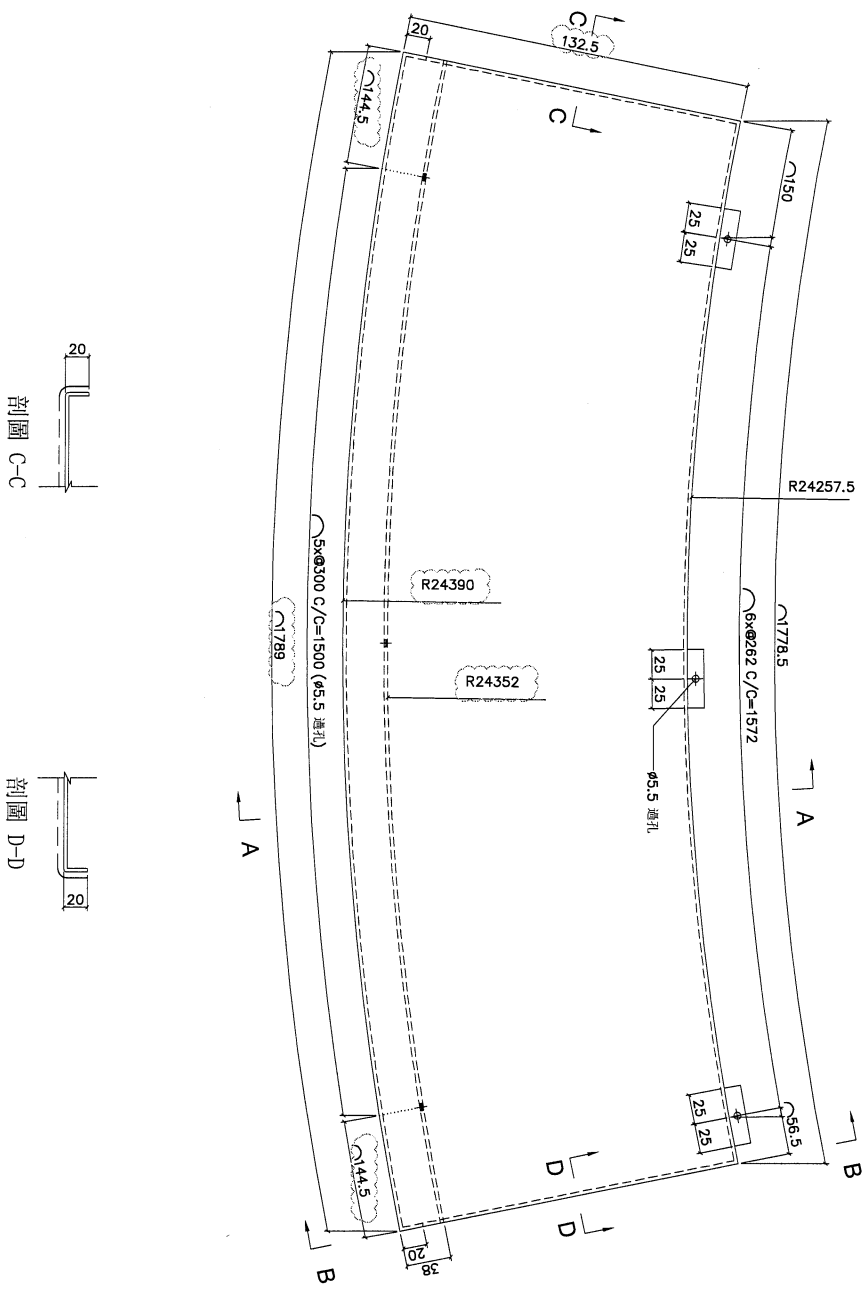

DWG. NO.

FW-T104

REV. A

SCALE

DATE 06-07-2024

DRAWN BY

APPROVED BY

PROJECT
YIN PING ROAD KOWLOON
FEATURE WALL (PHASE 2)

MATERIAL
3mm铝板

COATING
PVF2

COLOUR
EC-DG-D334232-ZD1(SS-011)

MARK. NO.
-

QTY.
-

CHKD BY	PART NUMBER	Dim. A	Dim. B	Dim. C	Dim. D	Dim. E	Dim. F	Dim. G	Dim. H	QTY.	Inv. Code	ASSEMBLE ON PARTS
FW-1105										1		ASSEMBLE ON PARTS

注：用于 B 区域

地盤用

用A3紙打印

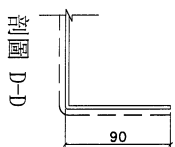
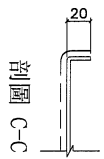
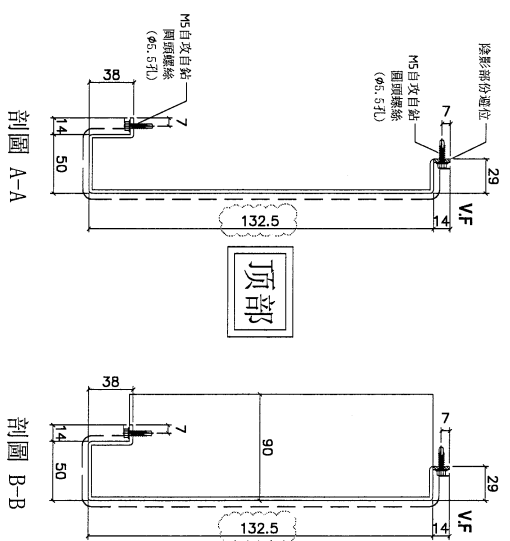
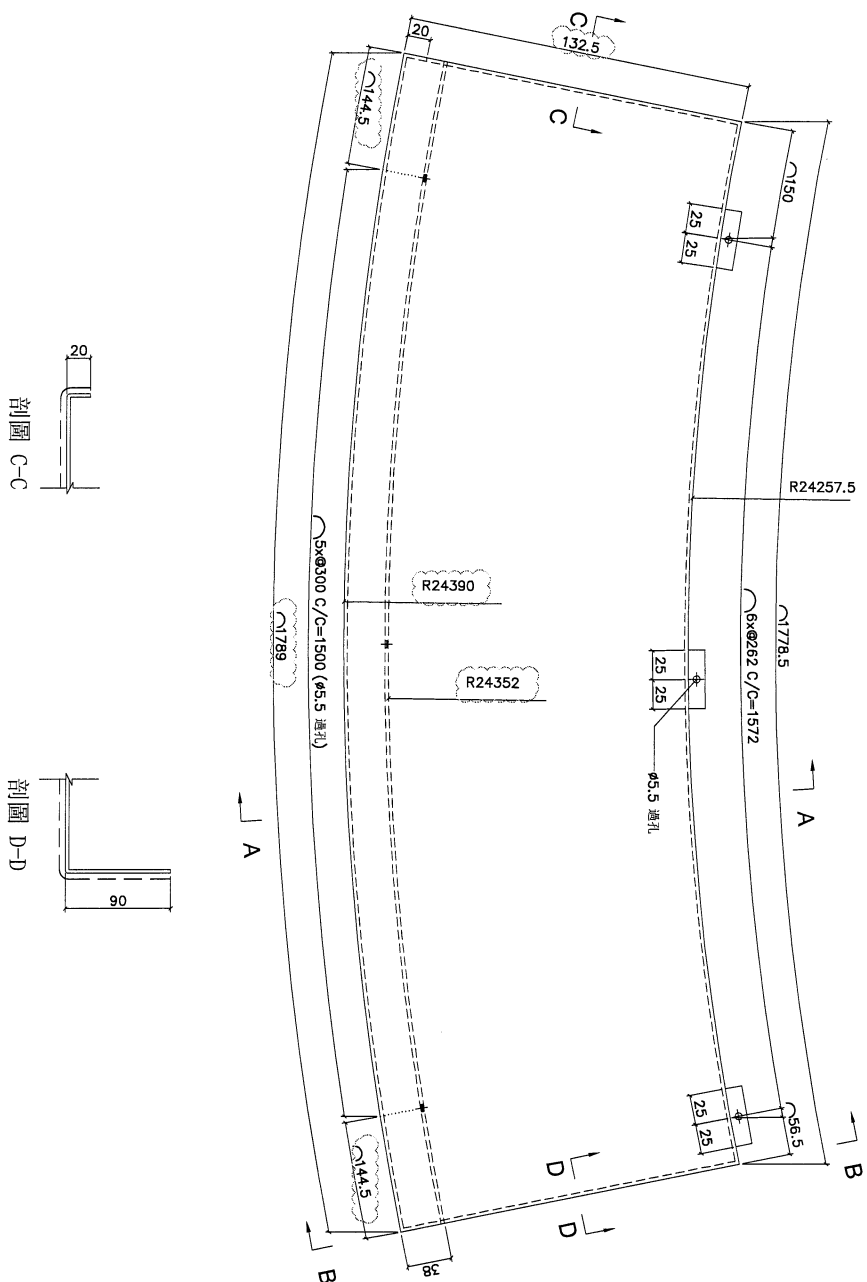

DWG. NO.	FW-1105	REV.	A	SCALE	-	DATE	06-07-2024	DRAWN BY	-	APPROVED BY	-
----------	---------	------	---	-------	---	------	------------	----------	---	-------------	---

PROJECT YIN PING ROAD KOWLOON
FEATURE WALL (PHASE 2)

MATERIAL 3mm铝板

COATING PVF2

COLOUR EC-DG-D334232-ZD1(SS-01)

MARK. NO. -

QTY. -

REV. / CHK BY	PART NUMBER	Dim. A	Dim. B	Dim. C	Dim. D	Dim. E	Dim. F	Dim. G	Dim. H	QTY.	Inv. Code	ASSEMBLE ON PARTS
-	FW-T106	-	-	-	-	-	-	-	-	1		注：用于A区域

地盤用

用A3紙打印

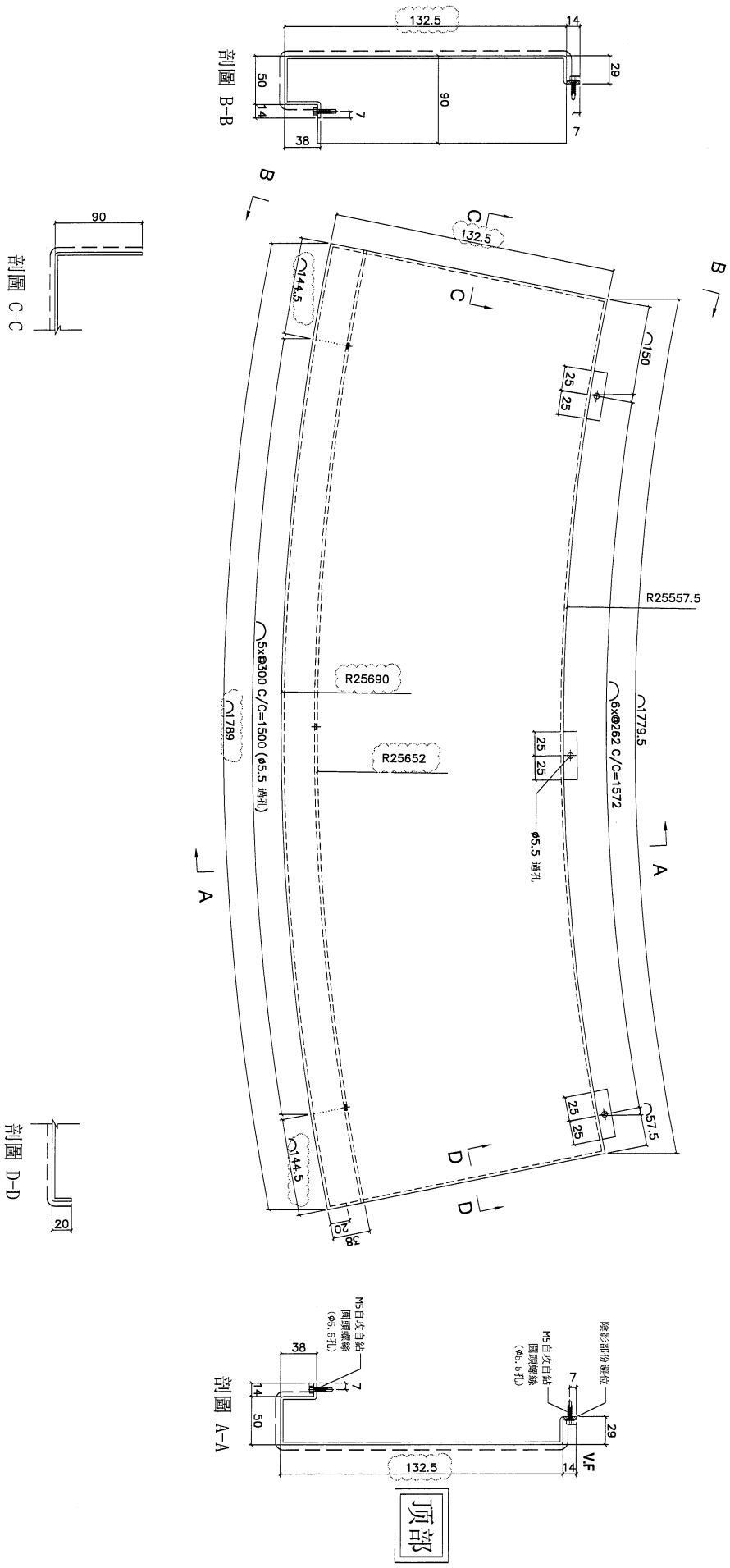

DWG. NO.	FW-T106	REV.	A	SCALE	-	DATE	06-07-2024	DRAWN BY	-	APPROVED BY	-
----------	---------	------	---	-------	---	------	------------	----------	---	-------------	---

PROJECT
YIN PING ROAD KOWLOON
FEATURE WALL (PHASE 2)

MATERIAL
3mm铝板

COATING
PVF2

COLOUR
EC-DG-D34232-ZD1(SS-01)

MARK. NO.
-

QTY.
-

REV.	CHECKED DATE BY	PART NUMBER	Dim. A	Dim. B	Dim. C	Dim. D	Dim. E	Dim. F	Dim. G	Dim. H	QTY.	Inv. Code	ASSEMBLE ON PARTS
-		FW-1107	-	-	-	-	-	-	-	-	4		注：用于A区域

地盤用

用A3紙打印

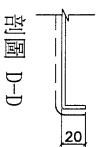
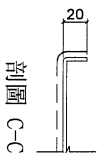
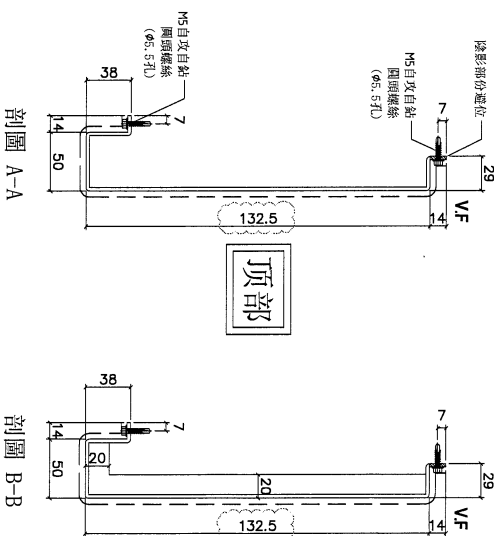
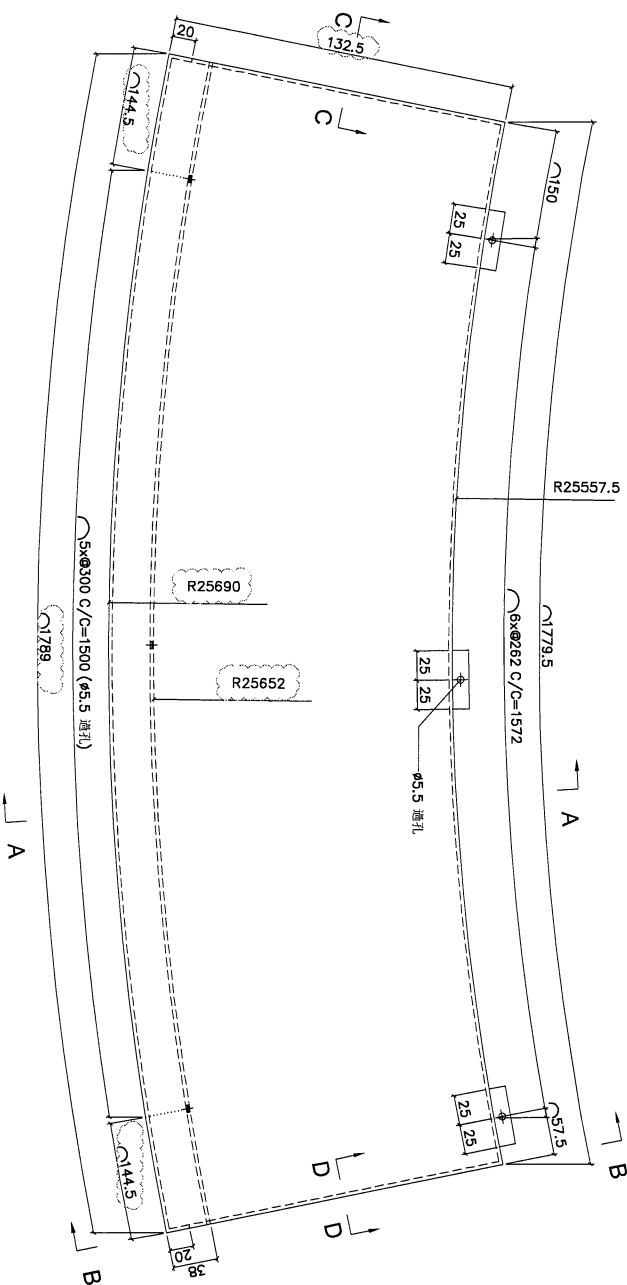

DWG. NO.

FW-1107

REV.

A

SCALE

-

DATE

06-07-2024

DRAWN BY

-

APPROVED BY

-

PROJECT
YIN PING ROAD KOWLOON
FEATURE WALL (PHASE 2)

MATERIAL
3mm鋁板

COATING
PVF2

COLOUR
EC-DG-D334232-ZD1(SS-01)

MARK. NO.
-

QTY.
-

REV. / CHECKED / DATE	PART NUMBER	Dim. A	Dim. B	Dim. C	Dim. D	Dim. E	Dim. F	Dim. G	Dim. H	QTY.	Inv. Code	ASSEMBLE ON PARTS
-	FW-1108	-	-	-	-	-	-	-	-	1	-	注：用于A区域

地盤用

用A3紙打印

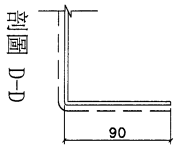
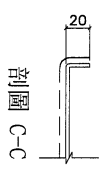
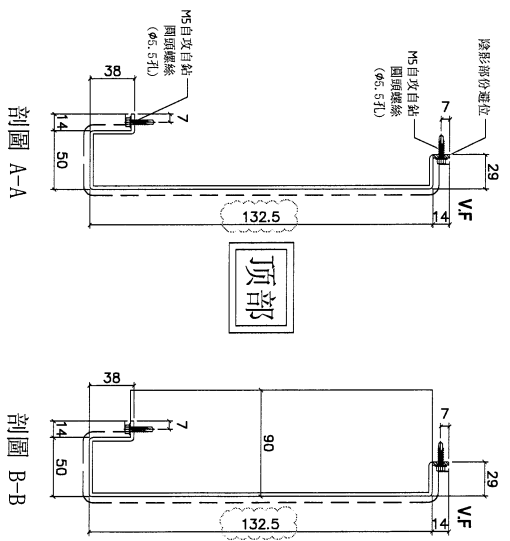
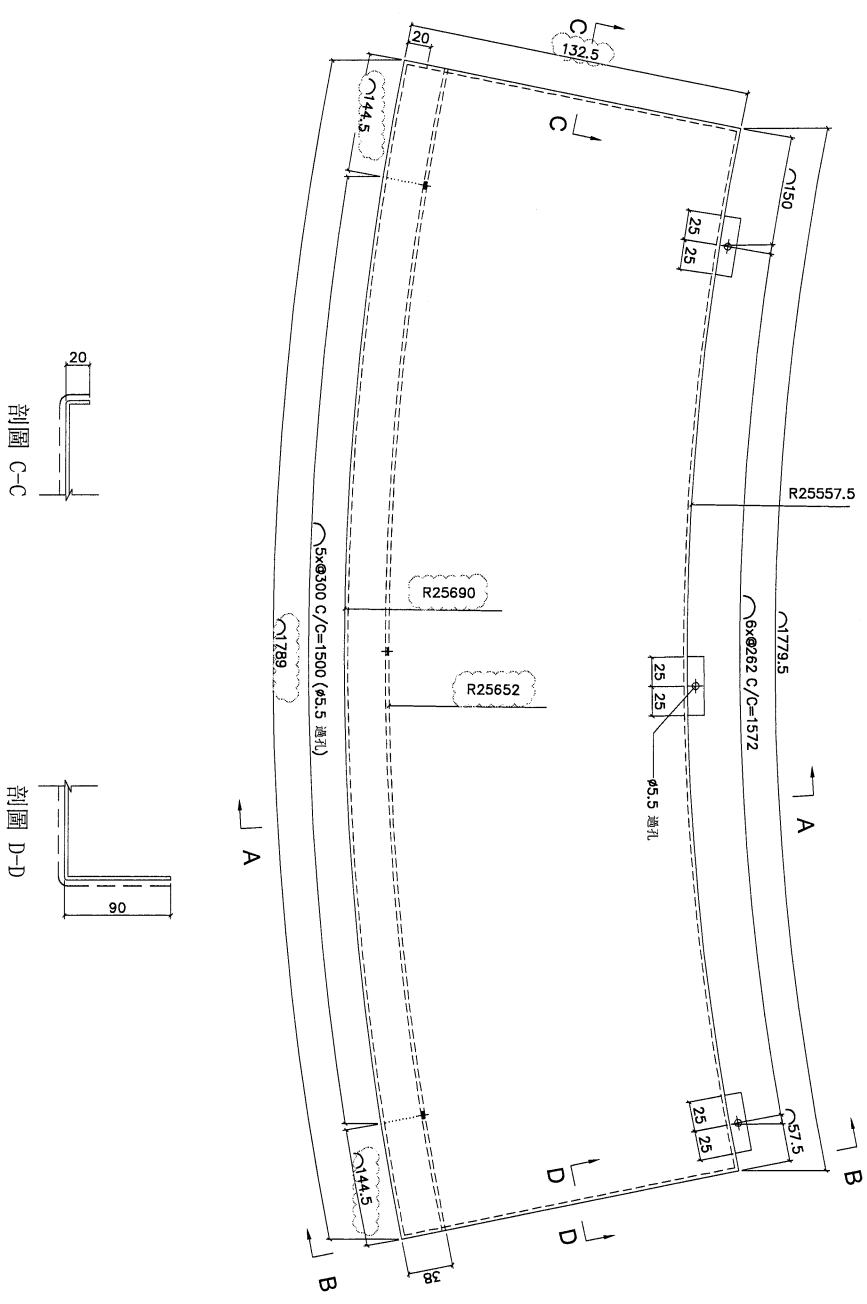

DWG. NO.	FW-1108	REV.	A	SCALE	-	DATE	06-07-2024	DRAWN BY	-	APPROVED BY	-
----------	---------	------	---	-------	---	------	------------	----------	---	-------------	---

PROJECT				MATERIAL				COATING				COLOUR				MARK. NO.		QTY.	
YIN PING ROAD KOWLOON FEATURE WALL (PHASE 2)				3mm铝板				PVF2				EC-DG-D334232-ZD1(SS-01)				-		-	
REV.	CHECKED DATE BY	PART NUMBER	Dim. A	Dim. B	Dim. C	Dim. D	Dim. E	Dim. F	Dim. G	Dim. H	QTY.	Inv. Code	ASSEMBLE ON PARTS						
-		FW-T109	-	-	-	-	-	-	-	-	1		注：用于A区域				地盤用		
用A3紙打印																			

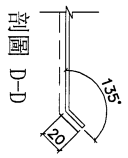
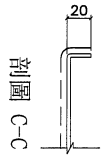
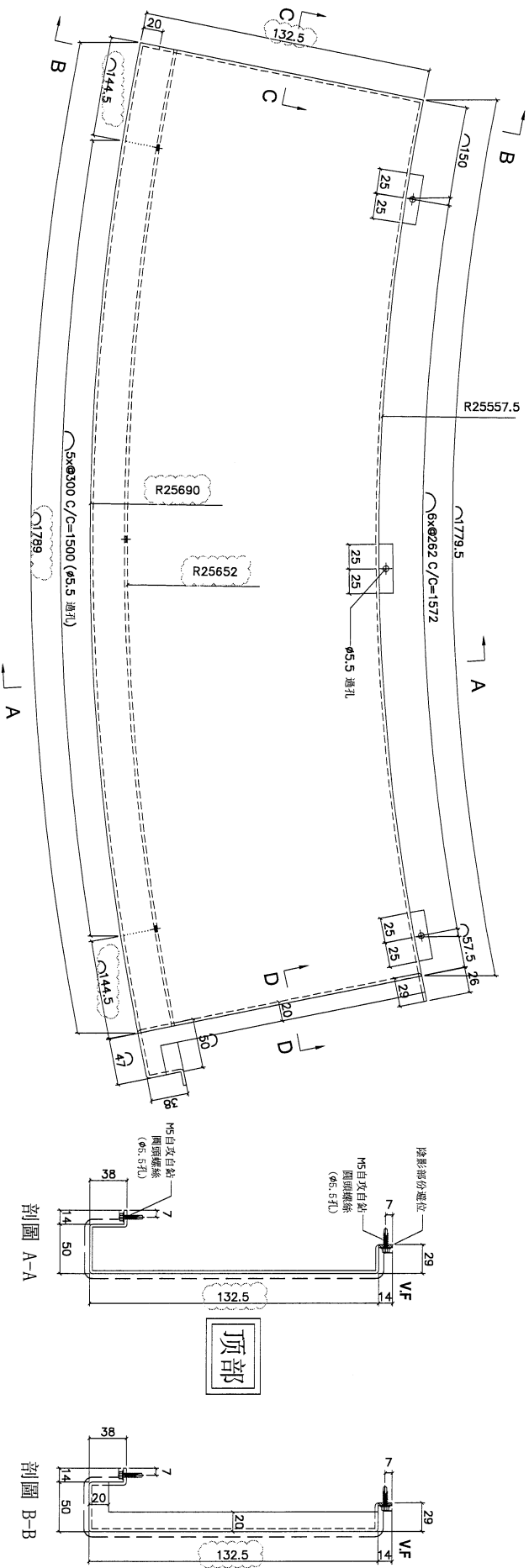

DWG. NO.	REV.	SCALE	DATE	DRAWN BY	APPROVED BY
FW-T109	A	-	06-07-2024		

PROJECT				YIN PING ROAD KOWLOON FEATURE WALL (PHASE 2)				MATERIAL				3mm鋁板				COATING				PVF2				COLOUR				EC-DG-D334232-ZD1(SS-01)				MARK. NO.				QTY.			
REV. / 更改		PART NUMBER		Dim. A		Dim. B		Dim. C		Dim. D		Dim. E		Dim. F		Dim. G		Dim. H		QTY.		Inv. Code		ASSEMBLE ON PARTS				MARK. NO.				QTY.							
-		FW-T110		-		-		-		-		-		-		-		-		1		-		注：用于A区域				-				-							
地盤用																																							
用A3紙打印																																							

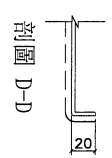
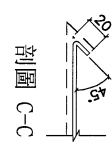
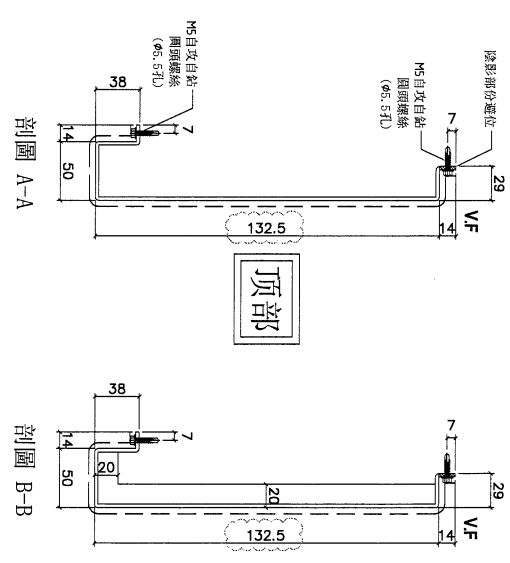
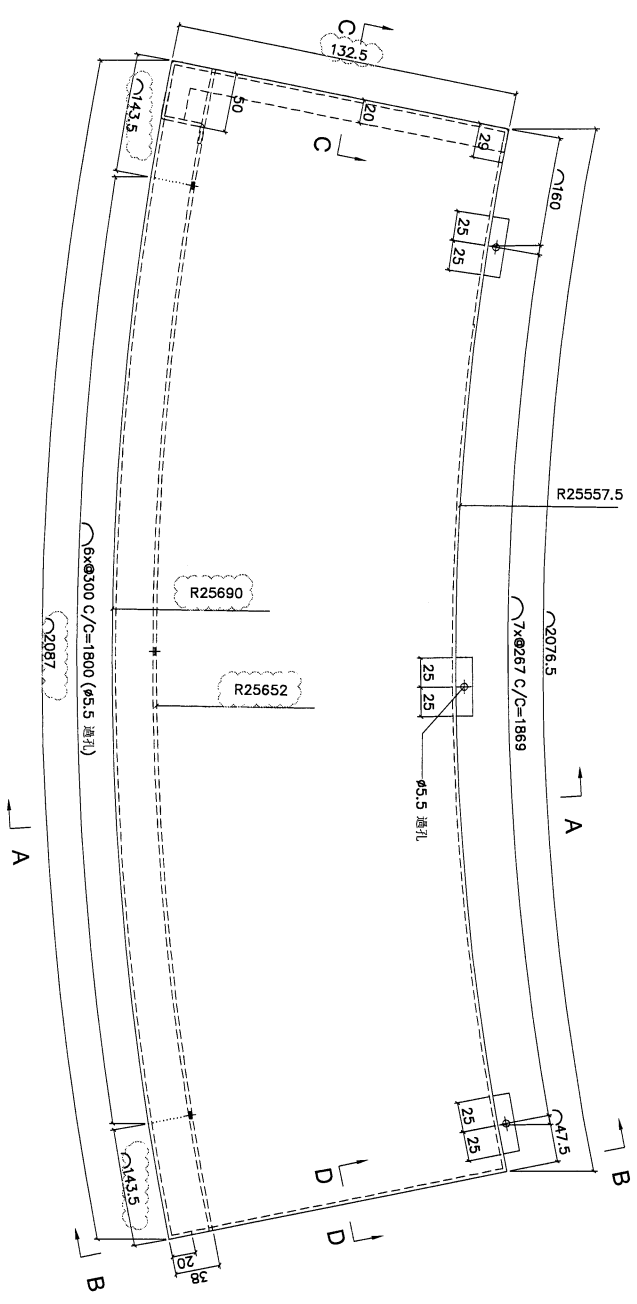

DWG. NO.		FW-T110		REV.		A		SCALE		DATE		06-07-2024		DRAWN BY		APPROVED BY	
----------	--	---------	--	------	--	---	--	-------	--	------	--	------------	--	----------	--	-------------	--

PROJECT
YIN PING ROAD KOWLOON
FEATURE WALL (PHASE 2)

MATERIAL
3mm铝板

COATING
PVF2

COLOUR
EC-DG-D34232-ZD11(SS-01)

MARK. NO.
-

QTY.
-

REV.	CHECKED BY	PART NUMBER	Dim. A	Dim. B	Dim. C	Dim. D	Dim. E	Dim. F	Dim. G	Dim. H	QTY.	Inv. Code	ASSEMBLE ON PARTS
-		FW-T111	-	-	-	-	-	-	-	-	1		

注：用于B区域

地盘用

用A3纸打印

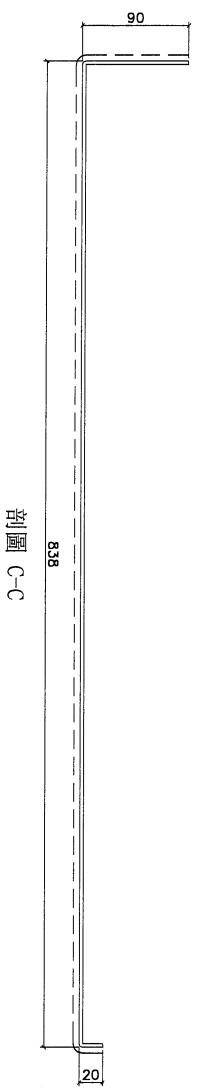
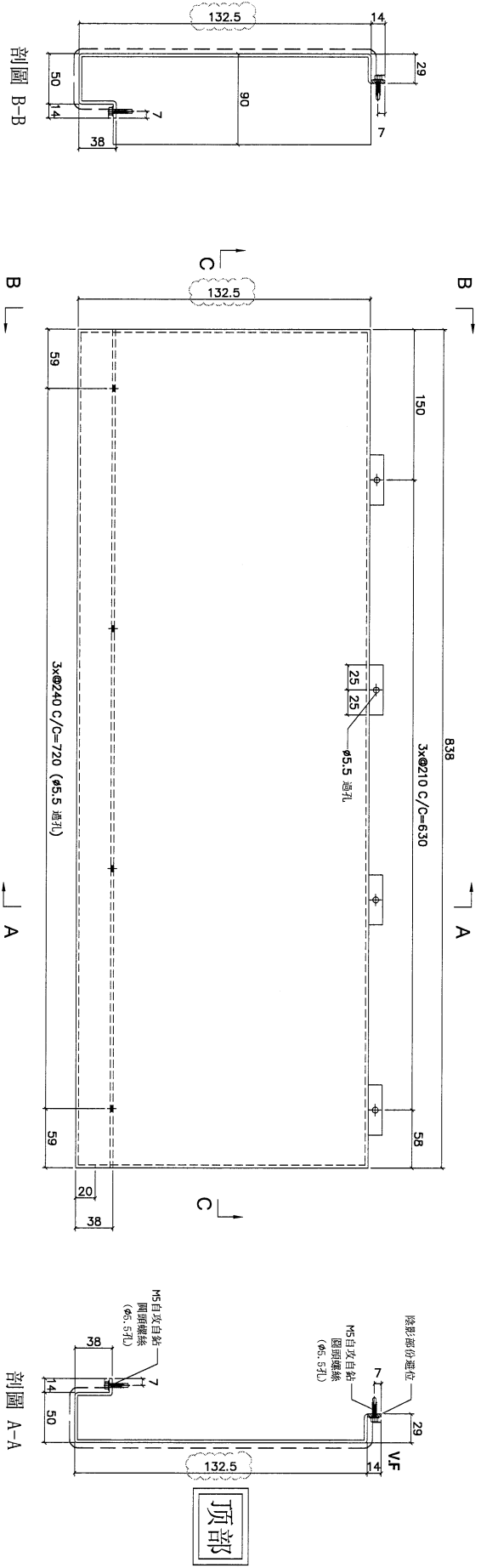

DWG. NO.	FW-T111	REV.	A	SCALE	-	DATE	06-07-2024	DRAWN BY	-	APPROVED BY	-
----------	---------	------	---	-------	---	------	------------	----------	---	-------------	---

PROJECT
YIN PING ROAD KOWLOON
FEATURE WALL (PHASE 2)

MATERIAL
3mm铝板

COATING
PVF2

COLOUR
EC-DG-D334232-ZD1(SS-01)

MARK. NO.
-

QTY.
-

REV.	CHANGED BY	PART NUMBER	Dim. A	Dim. B	Dim. C	Dim. D	Dim. E	Dim. F	Dim. G	Dim. H	QTY.	Inv. Code	ASSEMBLE ON PARTS
-		FW-T112	-	-	-	-	-	-	-	-	1		注: 用于 B 区域

地盤用

用A3紙打印

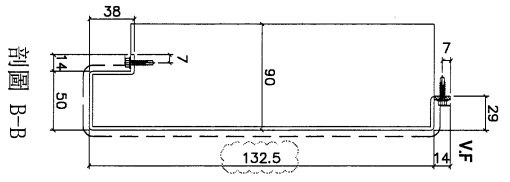
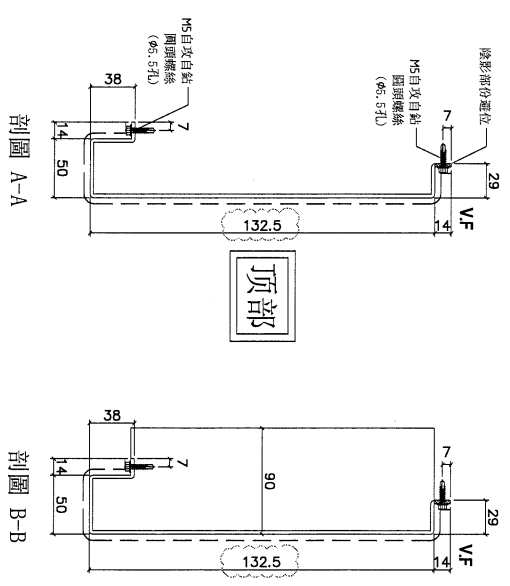
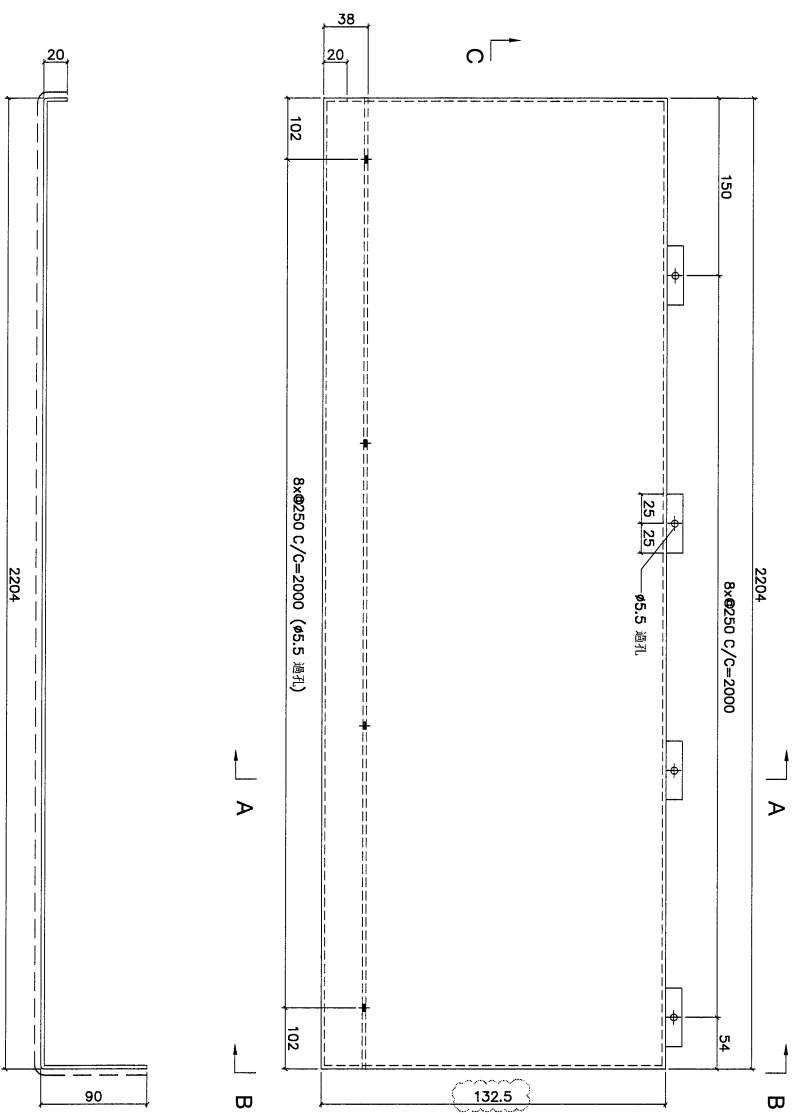

剖面 C-C

DWG. NO.

FW-T112

REV. A

SCALE

DATE
06-07-2024

DRAWN BY

APPROVED BY

PROJECT
YIN PING ROAD KOWLOON
FEATURE WALL (PHASE 2)

MATERIAL
3mm铝板

COATING
PVF2

COLOUR
EC-DG-D334232-ZD11(SS-01)

MARK. NO.
-

QTY.
-

REV.	CHECKED DATE BY	PART NUMBER	Dim. A	Dim. B	Dim. C	Dim. D	Dim. E	Dim. F	Dim. G	Dim. H	QTY.	Inv. Code	ASSEMBLE ON PARTS	MARK. NO.	QTY.
-		FW-T113	-	-	-	-	-	-	-	-	1		ASSEMBLE ON PARTS	-	-

地盤用

用A3紙打印

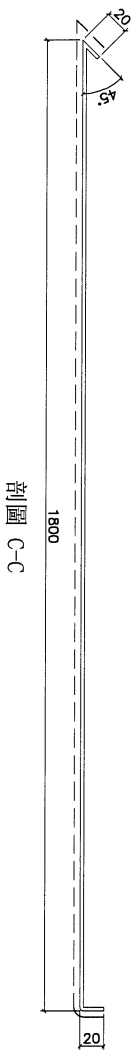
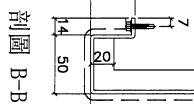
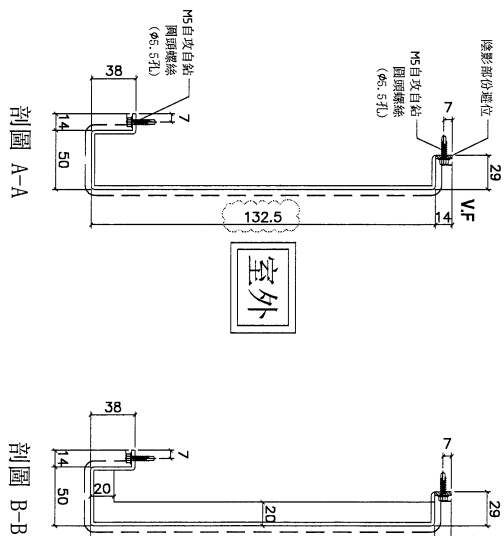
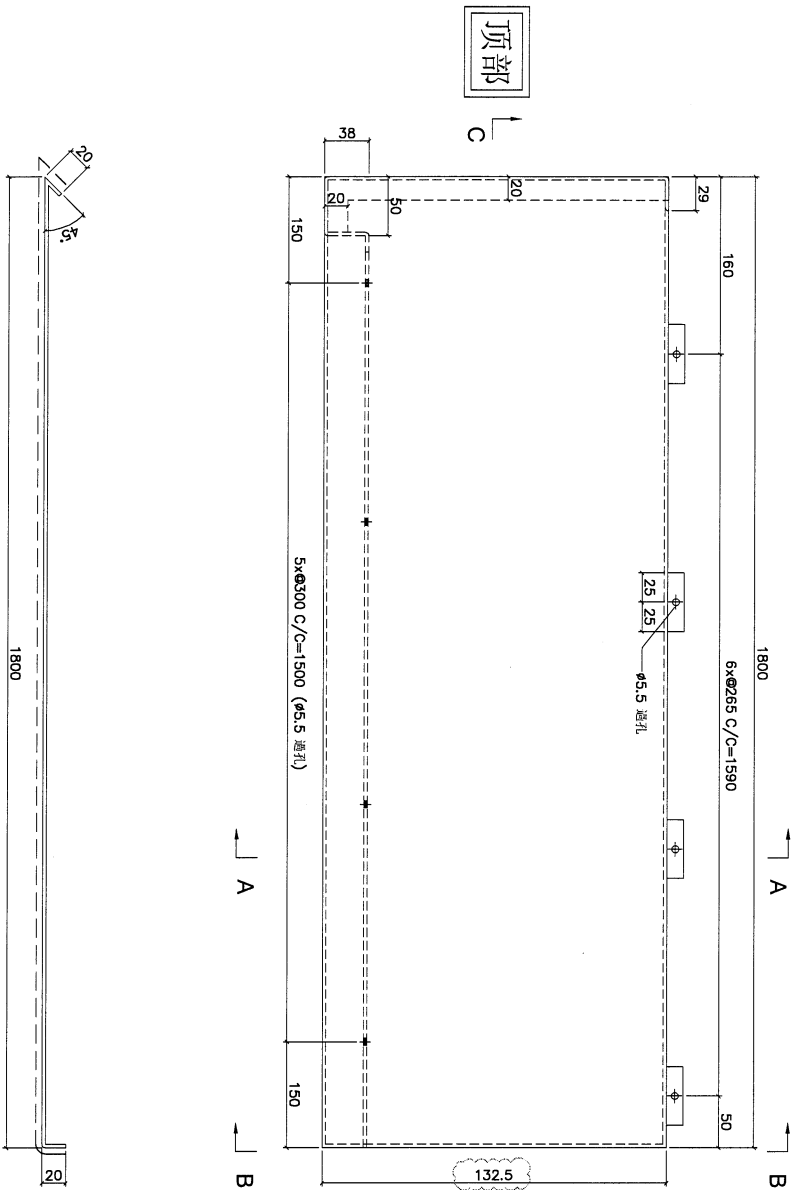

DWG. NO.

FW-T113

REV.
A

SCALE
-

DATE
06-07-2024

DRAWN BY
-

APPROVED BY
-

PROJECT
YIN PING ROAD KOWLOON
FEATURE WALL (PHASE 2)

MATERIAL
3mm铝板

COATING
PVF2

COLOUR
EC-DG-D334232-ZD1(SS-01)

MARK. NO.
-

QTY.
-

REV. / 更改	PART NUMBER	Dim. A	Dim. B	Dim. C	Dim. D	Dim. E	Dim. F	Dim. G	Dim. H	QTY.	Inv. Code
-	FW-1115	-	-	-	-	-	-	-	-	1	

注：用于B区域

ASSEMBLE ON PARTS

地盘用

用A3纸打印

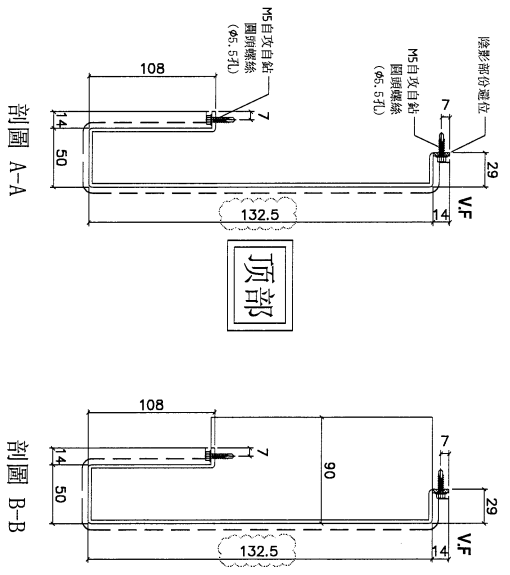
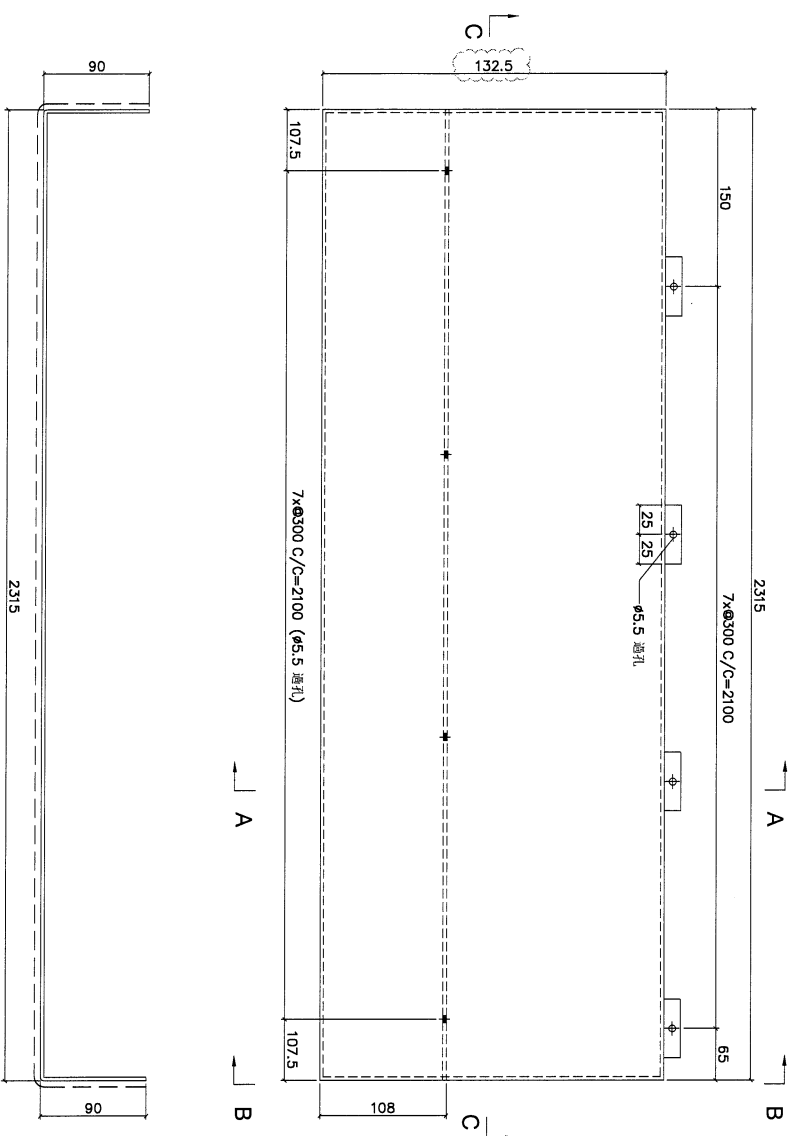

剖面 C-C

DWG. NO.

FW-1115

REV. A

SCALE

DATE
06-07-2024

DRAWN BY

APPROVED BY

PROJECT				MATERIAL				COATING				COLOUR				MARK. NO.		QTY.	
YIN PING ROAD KOWLOON FEATURE WALL (PHASE 2)				3mm鋁板				PVF2				EC-DG-D334232-ZD1(SS-01)				-		-	
REV.	CHECKED DATE BY	PART NUMBER	Dim. A	Dim. B	Dim. C	Dim. D	Dim. E	Dim. F	Dim. G	Dim. H	QTY.	Inv. Code	ASSEMBLE ON PARTS						
-		FW-T301	-	-	-	-	-	-	-	-	2		注: 用于 B 区域				地盤用		
													用A3紙打印						

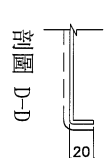
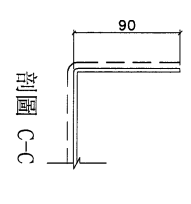
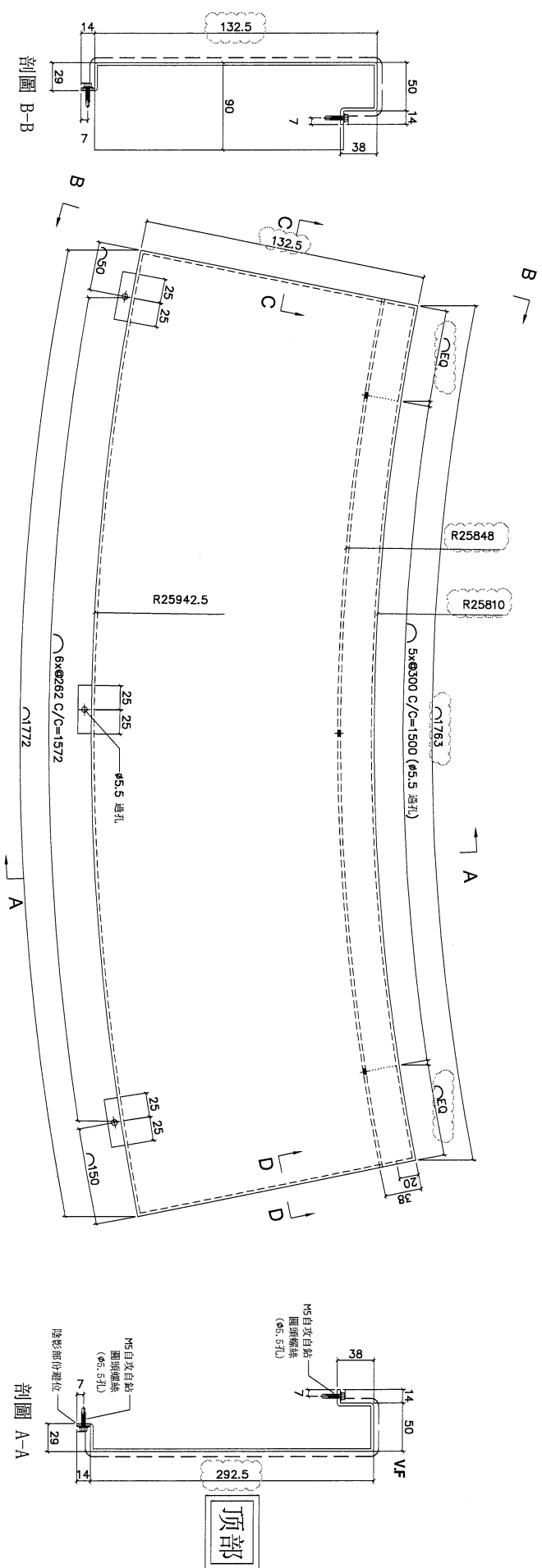

DWG. NO.		REV.		SCALE		DATE		DRAWN BY		APPROVED BY	
FW-T301		A		-		06-07-2024		-		-	

PROJECT
YIN PING ROAD KOWLOON
FEATURE WALL (PHASE 2)

MATERIAL
3mm铝板

COATING
PVF2

COLOUR
EC-DG-D334232-ZD1(SS-01)

MARK. NO.
-

QTY.
-

REV.	CHECKED DATE BY	PART NUMBER	Dim. A	Dim. B	Dim. C	Dim. D	Dim. E	Dim. F	Dim. G	Dim. H	QTY.	Inv. Code	ASSEMBLE ON PARTS
-		FW-T302	-	-	-	-	-	-	-	-	4		注：用于B区域

地盤用

用A3紙打印

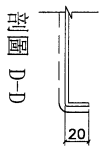
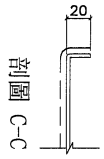
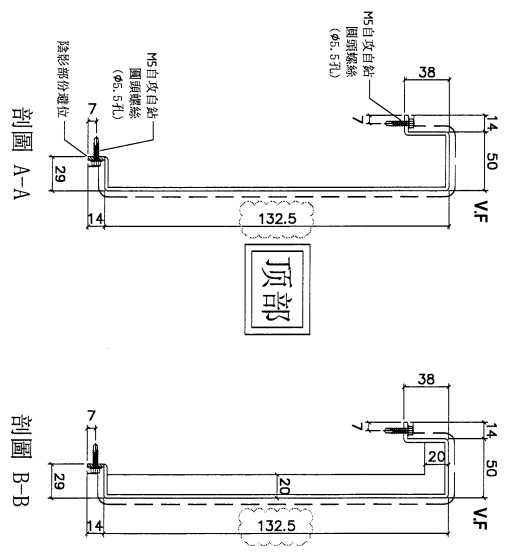
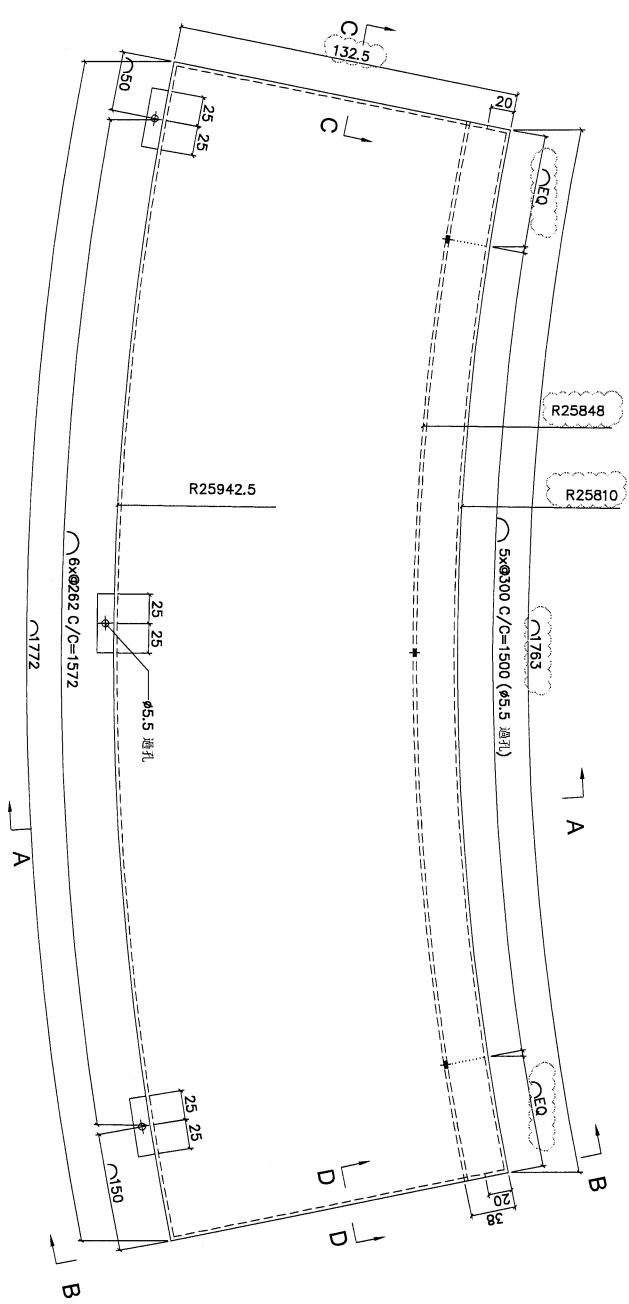

DWG. NO.	FW-T302	REV.	A	SCALE	-	DATE	06-07-2024	DRAWN BY	-	APPROVED BY	-
----------	---------	------	---	-------	---	------	------------	----------	---	-------------	---

PROJECT
YIN PING ROAD KOWLOON
FEATURE WALL (PHASE 2)

MATERIAL
3mm铝板

COATING
PVF2

COLOUR
EG-DG-D334232-ZD1(SS-01)

MARK. NO.
-

QTY.
-

REV. CHECKED DRAWN BY	PART NUMBER	Dim. A	Dim. B	Dim. C	Dim. D	Dim. E	Dim. F	Dim. G	Dim. H	QTY.	Inv. Code	ASSEMBLE ON PARTS
-	FW-T303	-	-	-	-	-	-	-	-	1	-	注：用于B区域

地盤用

用A3紙打印

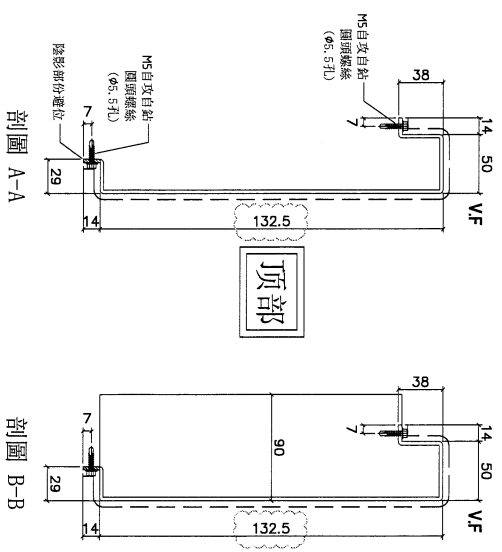
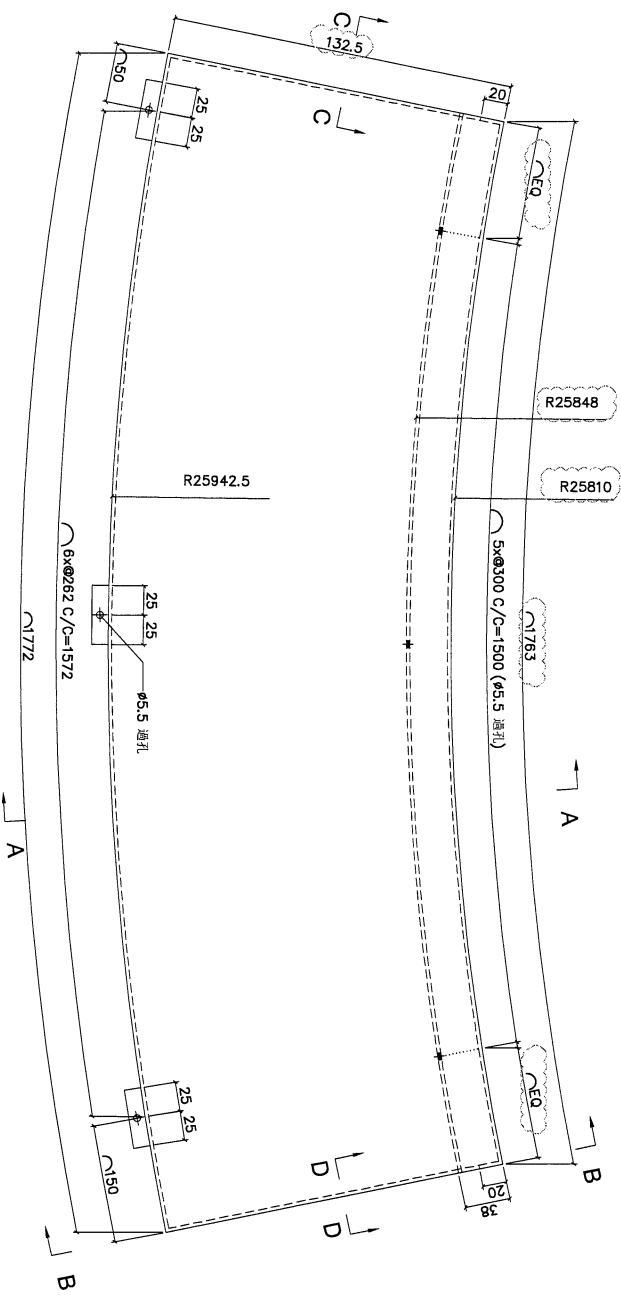

DWG. NO.	FW-T303	REV.	A	SCALE	-	DATE	06-07-2024	DRAWN BY	-	APPROVED BY	-
----------	---------	------	---	-------	---	------	------------	----------	---	-------------	---