

工程指示 / 要求簡箋 ENGINEER INSTRUCTIONS(E.I.)

工程指示編號:	EI- 7526	修改版本:	-
	HK-0532		
工程編號:	J 853	工程名稱:	延坪道 (第2期)
收件人:	Maggie Lo	發件人:	Joe Chan
工程項目:	第二期 Feature Wall 項目 鋁料拉彎	日期:	22/03/2024

<input type="checkbox"/> 原合約工程包	<input type="checkbox"/> 原合約工程加 / 減賬 QT-	<input type="checkbox"/> 新工程報價 QT-
---------------------------------	--	------------------------------------

信件批核號碼/圖紙參考編號:	批核模具圖紙編號:
客戶指示附件:	管理內部批簽署:

<input type="checkbox"/> 初步鋁料 B.M.	<input type="checkbox"/> 加工拆圖, 然後生產	<input type="checkbox"/> 尺寸表
<input type="checkbox"/> 正式鋁料 B.M.	<input type="checkbox"/> 技術上資料/指示	<input type="checkbox"/> 報價
<input type="checkbox"/> 配件 B.M.	<input type="checkbox"/> 樣辦或貨品說明書	<input type="checkbox"/> 分判合約
<input type="checkbox"/> 其他:		

內容:	附上拉彎圖紙, 確認拉彎 (T4 鋁料送回廠後, 送拉彎廠拉彎, 拉彎後送噴塗)
完成上列要求日期:	

國內

<input type="checkbox"/> 生產技術總監	<input type="checkbox"/> 連附件	<input type="checkbox"/> 技術部	<input type="checkbox"/> 連附件	<input type="checkbox"/> 生產部	<input type="checkbox"/> 連附件
<input type="checkbox"/> 採購部	<input type="checkbox"/> 連附件	<input checked="" type="checkbox"/> 生產統籌部	<input checked="" type="checkbox"/> 連附件	<input type="checkbox"/> 報關組	<input type="checkbox"/> 連附件
<input type="checkbox"/> 質檢部	<input type="checkbox"/> 連附件	<input type="checkbox"/> 會計部	<input type="checkbox"/> 連附件	<input type="checkbox"/> 機械設計部	<input type="checkbox"/> 連附件
<input type="checkbox"/> 香港辦	<input type="checkbox"/> 連附件	<input type="checkbox"/> 其他:			

香港

<input type="checkbox"/> 行政部	<input type="checkbox"/> 連附件	<input type="checkbox"/> 會計部	<input type="checkbox"/> 連附件	<input type="checkbox"/> 統籌部	<input type="checkbox"/> 連附件	<input type="checkbox"/> 工程部	<input type="checkbox"/> 連附件
<input type="checkbox"/> 採購部	<input type="checkbox"/> 連附件	<input type="checkbox"/> QS部	<input type="checkbox"/> 連附件	<input type="checkbox"/> 地盤管理	<input type="checkbox"/> 連附件	<input type="checkbox"/> 維修部	<input type="checkbox"/> 連附件

*發件人簽署:		*組別成員批核簽署:	
傳遞編號:	HK0532/24	項目經理簽署:	



PROJECT  
YIN PING ROAD KOWLOON  
FEATURE WALL (PHASE 2)

MATERIAL  
铝通拉弯加工图

COATING  
PVF2

COLOUR  
EC-DG-D334232-ZD1

MARK. NO.  
-

QTY.  
-

REV.	CREATED DATE BY	PART NUMBER	Dim. A	Dim. B	Dim. C	Dim. D	Dim. E	Dim. F	Dim. G	Dim. H	QTY.	Inv. Code
-		LW01-M01	-	-	-	-	-	-	-	-	36	

ASSEMBLE ON PARTS

注: 工厂用

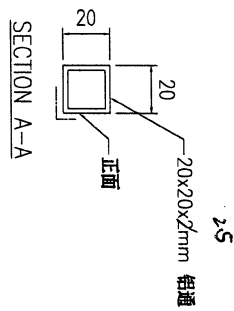
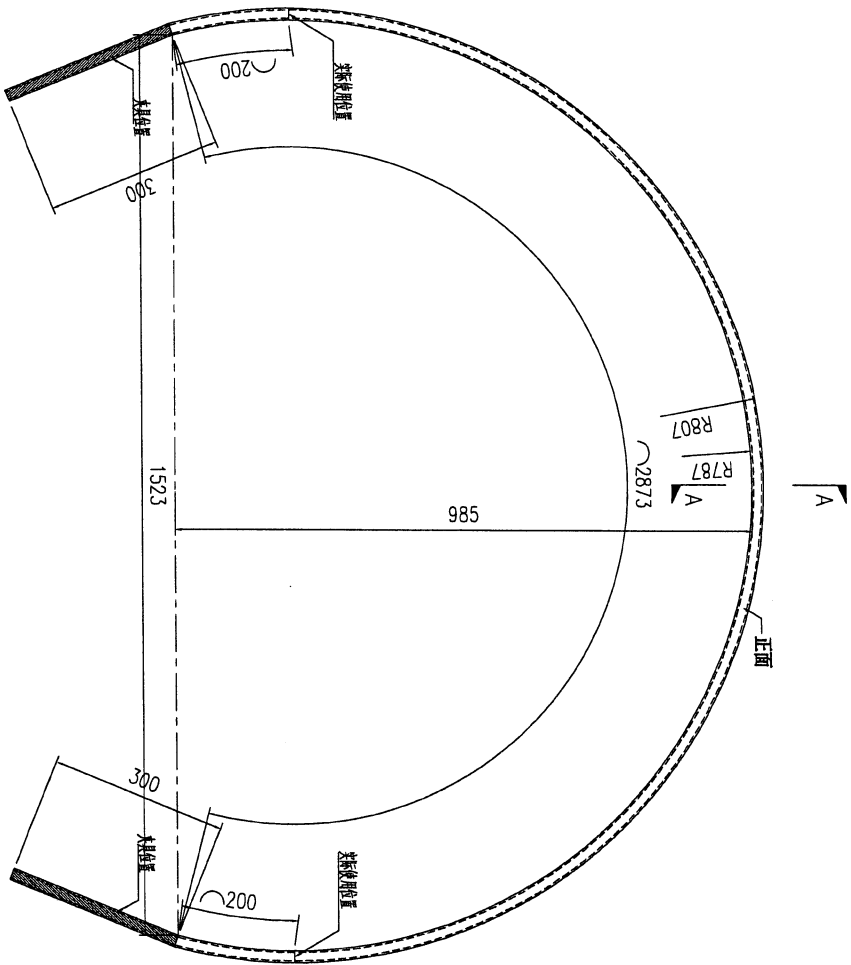

DWG. NO.

LW01-M01

REV.

SCALE

DATE  
08-03-2024

DRAWN BY

APPROVED BY

PROJECT  
YIN PING ROAD KOWLOON  
FEATURE WALL (PHASE 2)

MATERIAL  
铝通拉弯加工图

COATING  
PVF2

COLOUR  
EC-DG-D334232-ZD1

MARK. NO.  
-

QTY.  
-

REV.	CHECKED DATE	PART NUMBER	Dim. A	Dim. B	Dim. C	Dim. D	Dim. E	Dim. F	Dim. G	Dim. H	QTY.	Inv. Code
-		LW01-M02	-	-	-	-	-	-	-	-	36	

ASSEMBLE ON PARTS

注: 工厂用

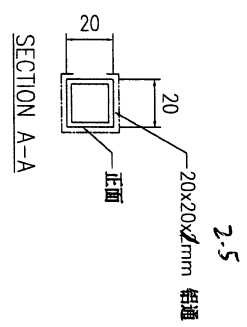
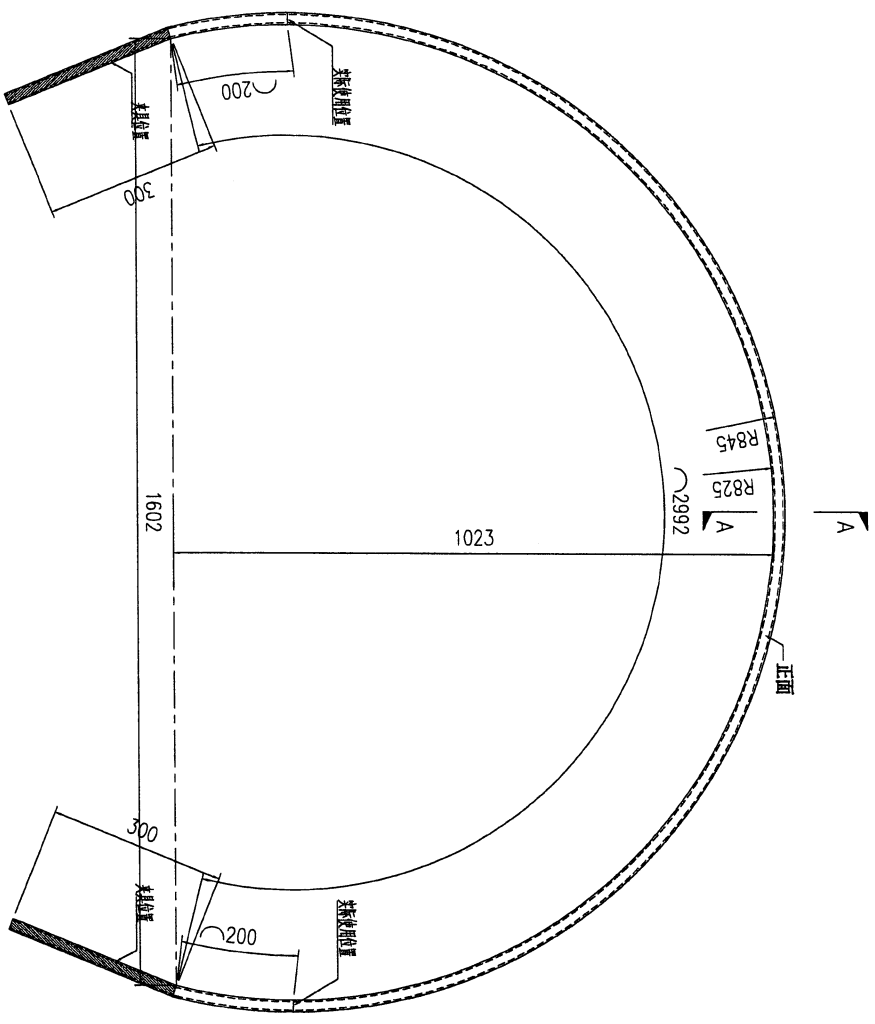

DWG. NO.	REV.	SCALE	DATE	DRAWN BY	APPROVED BY
LW01-M02	-	-	08-03-2024	-	-

PROJECT				MATERIAL				COATING				COLOUR				MARK. NO.		QTY.	
YIN PING ROAD KOWLOON FEATURE WALL (PHASE 2)				铝通拉弯加工图				PVF2				EC-DG-D334232-ZD1				-		-	
REV.	DESCRIPTION	PART NUMBER	Dim. A	Dim. B	Dim. C	Dim. D	Dim. E	Dim. F	Dim. G	Dim. H	QTY.	Inv. Code	ASSEMBLE ON PARTS				注: 工厂用		
-		LW01-M03	-	-	-	-	-	-	-	-	36								

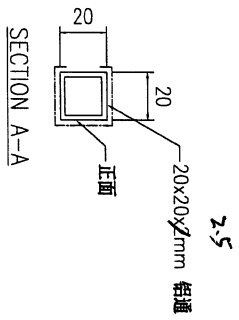
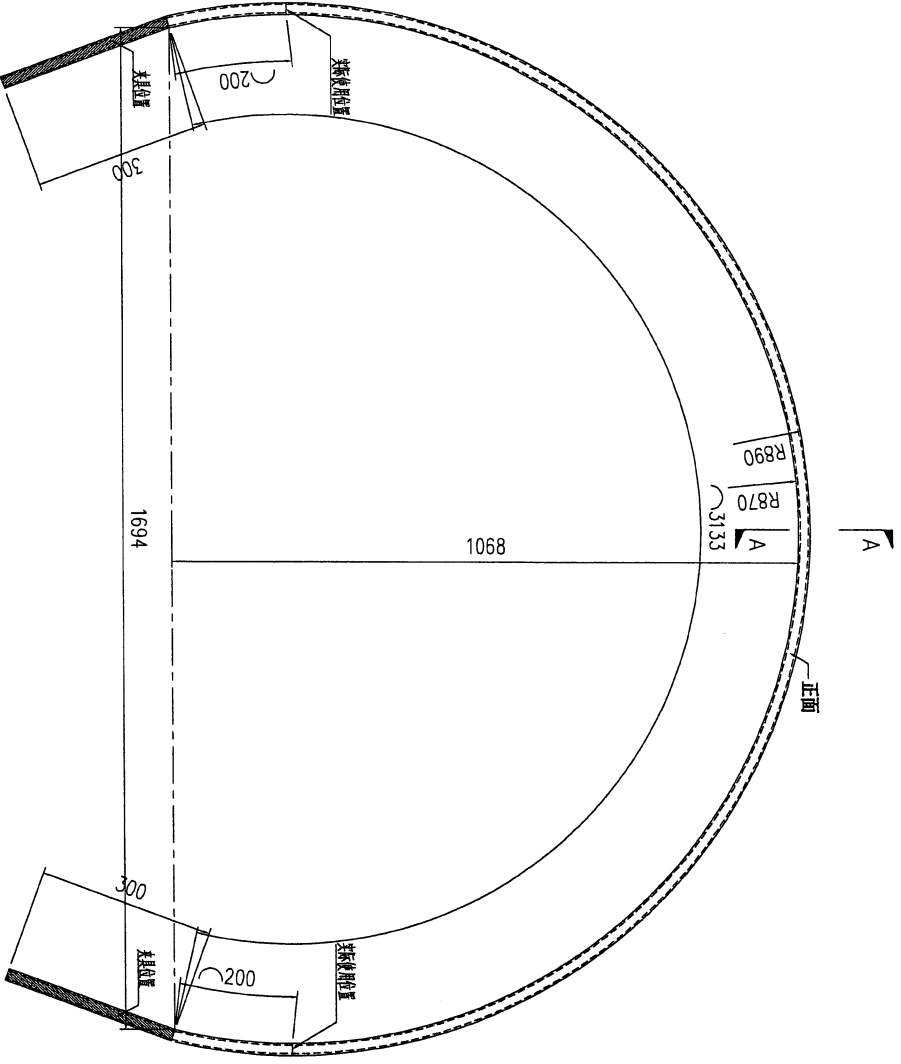

DWG. NO.		REV.		SCALE		DATE		DRAWN BY		APPROVED BY	
LW01-M03		-		-		08-03-2024		-		-	

PROJECT				MATERIAL				COATING				COLOUR		MARK. NO.		QTY.	
YIN PING ROAD KOWLOON FEATURE WALL (PHASE 2)				铝通拉弯加工图				PVF2				EC-DG-D334232-ZD1		-		-	
REV.	QTY.	PART NUMBER	Dim. A	Dim. B	Dim. C	Dim. D	Dim. E	Dim. F	Dim. G	Dim. H	QTY.	Inv. Code	ASSEMBLE ON PARTS				
-	-	LW01-M04	-	-	-	-	-	-	-	-	36	-	注: 工厂用				

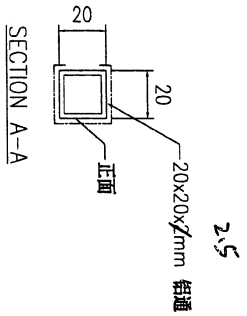
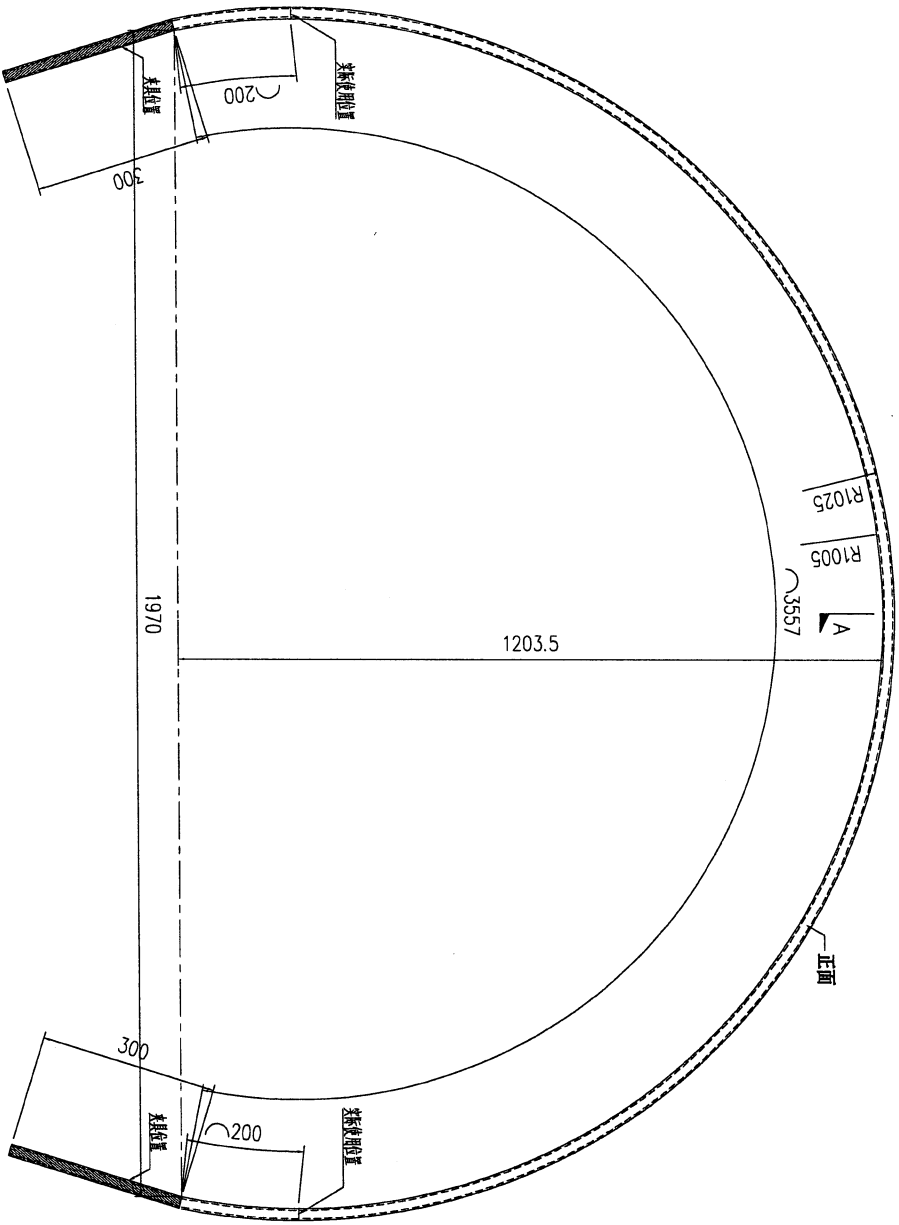

DWG. NO.		REV.		SCALE		DATE		DRAWN BY		APPROVED BY	
LW01-M04		-		-		08-03-2024		-		-	

PROJECT				MATERIAL				COATING				COLOUR				MARK. NO.		QTY.	
YIN PING ROAD KOWLOON FEATURE WALL (PHASE 2)				铝通拉弯加工图				PVF2				EC-DG-D334232-ZD1				-		-	
REV.	CHANGED REV. BY	PART NUMBER	Dim. A	Dim. B	Dim. C	Dim. D	Dim. E	Dim. F	Dim. G	Dim. H	QTY.	Inv. Code	ASSEMBLE ON PARTS				注: 工厂用		
-		LW02-M01	-	-	-	-	-	-	-	-	2						注: 工地复尺		

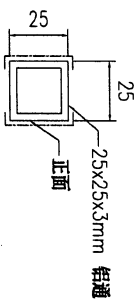
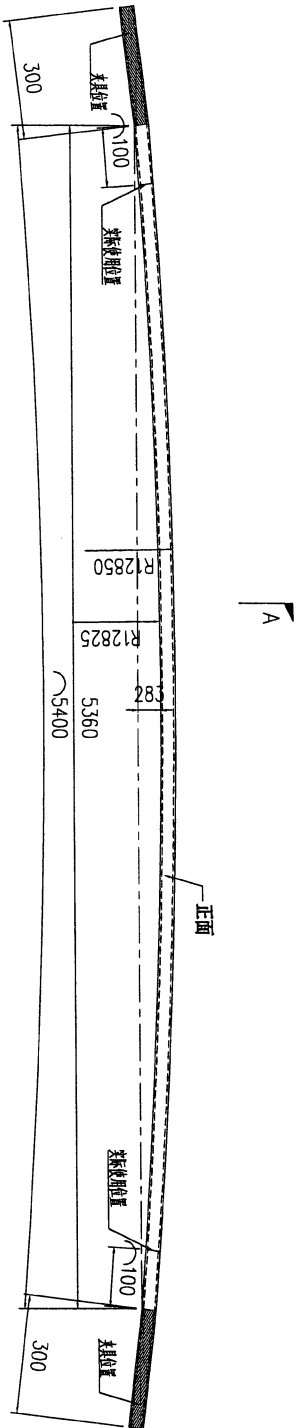

DWG. NO.		REV.		SCALE		DATE		DRAWN BY		APPROVED BY	
LW01-M01		-		-		08-03-2024		-		-	

PROJECT		YIN PING ROAD KOWLOON FEATURE WALL (PHASE 2)				MATERIAL		铝通拉弯加工图		COATING		PVF2		COLOUR		EC-DG-D334232-ZD1		MARK. NO.		QTY.	
checked and by	PART NUMBER	Dim. A	Dim. B	Dim. C	Dim. D	Dim. E	Dim. F	Dim. G	Dim. H	QTY.	Inv. Code	ASSEMBLE ON PARTS									
-	LW02-M02	-	-	-	-	-	-	-	-	4											
												注: 工厂用									
												注: 工地复尺									

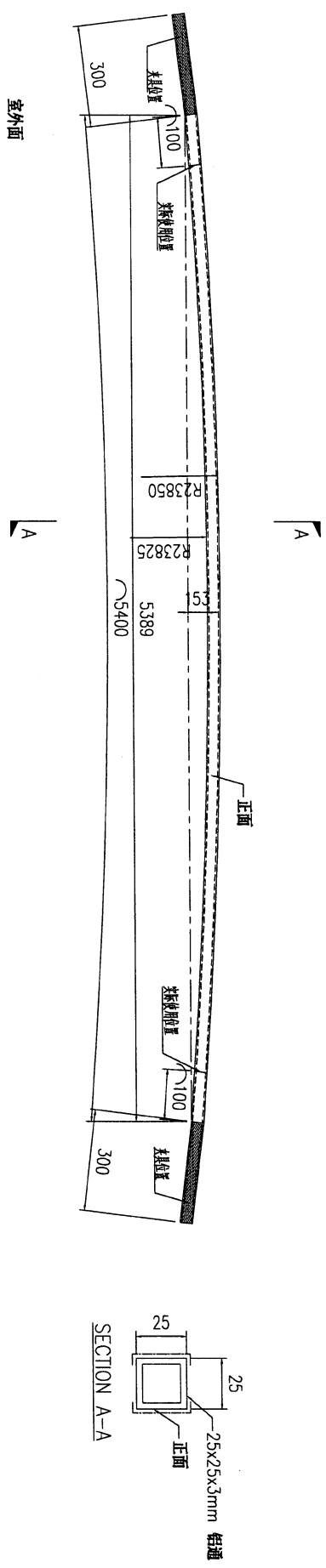

DWG. NO.		LW02-M02		REV.		SCALE		DATE		DRAWN BY		APPROVED BY	
								08-03-2024					

PROJECT				MATERIAL				COATING				COLOUR		MARK. NO.		QTY.	
YIN PING ROAD KOWLOON FEATURE WALL (PHASE 2)				铝通拉弯加工图				PVF2				EC-DG-D334232-ZD1		-		-	
REV. ORIGIN	PART NUMBER	Dim. A	Dim. B	Dim. C	Dim. D	Dim. E	Dim. F	Dim. G	Dim. H	QTY.	Inv. Code	ASSEMBLE ON PARTS					
-	LW02-M03	-	-	-	-	-	-	-	-	1							
													注: 工厂用				
													注: 工地复尺				

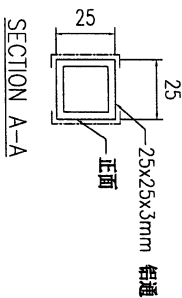
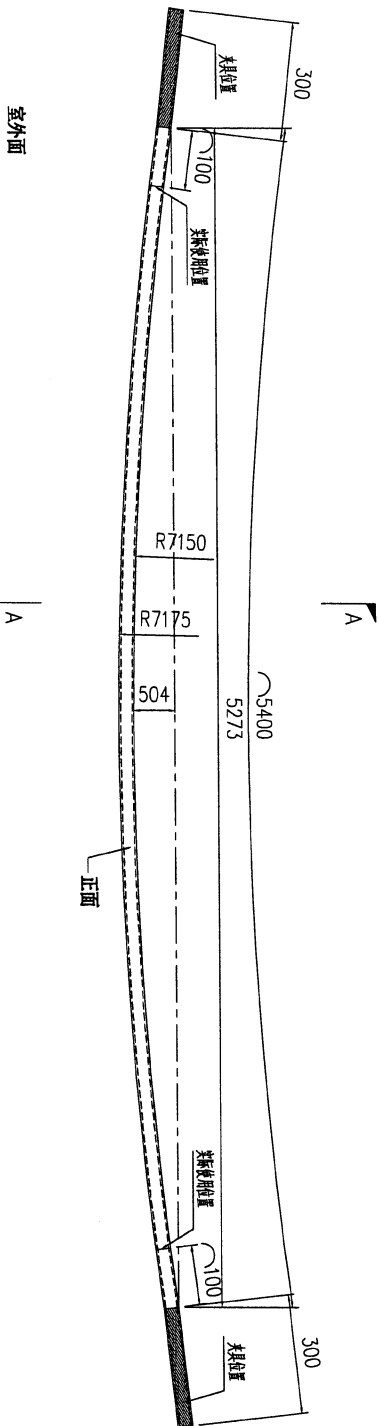

DWG. NO.		REV.		SCALE		DATE		DRAWN BY		APPROVED BY	
LW02-M03		-		-		08-03-2024		-		-	

PROJECT				MATERIAL				COATING				COLOUR		MARK. NO.		QTY.	
YIN PING ROAD KOWLOON FEATURE WALL (PHASE 2)				铝通拉弯加工图				PVF2				EC-DG-D334232-ZD1		-		-	
REV.	Checked Date	PART NUMBER	Dim. A	Dim. B	Dim. C	Dim. D	Dim. E	Dim. F	Dim. G	Dim. H	QTY.	Inv. Code	ASSEMBLE ON PARTS				
-		LW02-M04	-	-	-	-	-	-	-	-	4						
													注: 工厂用				
													注: 工地复尺				

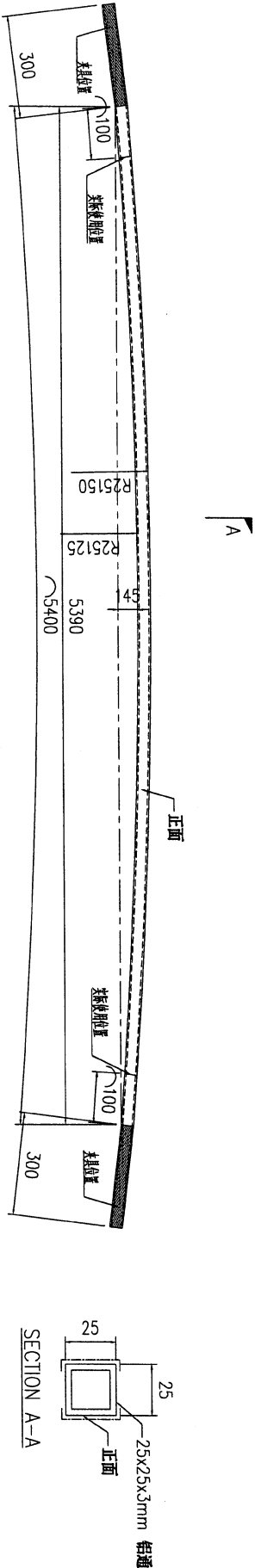

DWG. NO.		REV.		SCALE		DATE		DRAWN BY		APPROVED BY	
LW02-M04		-		-		08-03-2024		-		-	

PROJECT  
YIN PING ROAD KOWLOON  
FEATURE WALL (PHASE 2)

MATERIAL  
铝通拉弯加工图

COATING  
PVF2

COLOUR  
EC-DG-D334232-ZD1

MARK. NO.  
-

QTY.  
-

ASSEMBLE ON PARTS

注：工厂用

注：工地复尺

REV.	CHANGED DATE	PART NUMBER	Dim. A	Dim. B	Dim. C	Dim. D	Dim. E	Dim. F	Dim. G	Dim. H	QTY.	Inv. Code
-		LW02-M05	-	-	-						1	

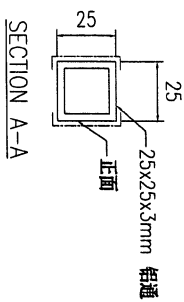
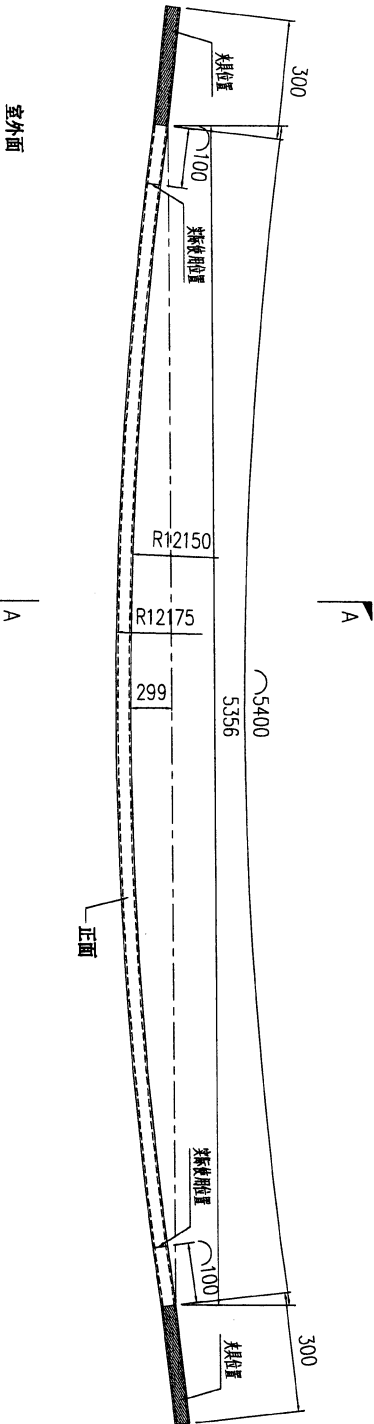

室外面

DWG. NO.

LW02-M05

REV.

-

SCALE

-

DATE

08-03-2024

DRAWN BY

-

APPROVED BY

-

PROJECT				MATERIAL				COATING		COLOUR		MARK. NO.		QTY.	
YIN PING ROAD KOWLOON FEATURE WALL (PHASE 2)				铝通拉弯加工图				PVF2		EC-DG-D334232-ZD1		-		-	
REV.	DESCRIBED REV. BY	PART NUMBER	Dim. A	Dim. B	Dim. C	Dim. D	Dim. E	Dim. F	Dim. G	Dim. H	QTY.	Inv. Code	ASSEMBLE ON PARTS		
-		LW03-M01	-	-	-	-	-	-	-	-	2				
													注: 工厂用		
													注: 工地复尺		

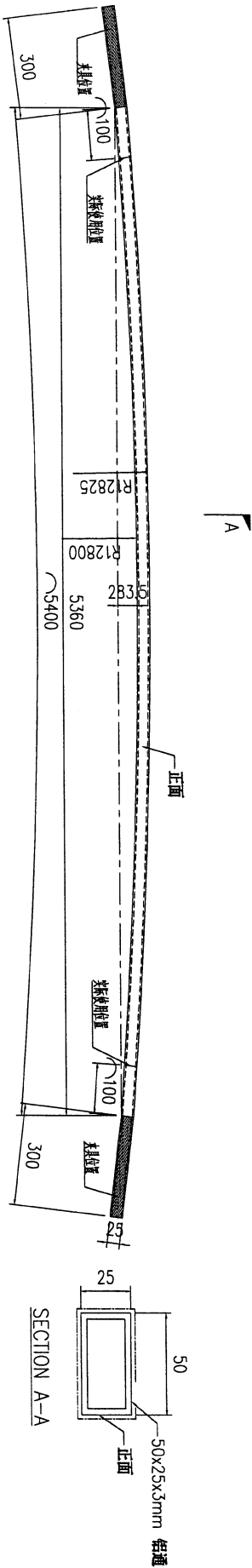

室外面

DWG. NO.		REV.		SCALE		DATE		DRAWN BY		APPROVED BY	
LW03-M01		-		-		08-03-2024		-		-	

PROJECT  
YIN PING ROAD KOWLOON  
FEATURE WALL (PHASE 2)

MATERIAL  
铝通拉弯加工图

COATING  
PVF2

COLOUR  
EC-DG-D334232-ZD1

MARK. NO.  
-

QTY.  
-

REV.	CHECKED DATE	PART NUMBER	Dim. A	Dim. B	Dim. C	Dim. D	Dim. E	Dim. F	Dim. G	Dim. H	QTY.	Inv. Code
-		LW03-M02	-	-	-	-	-	-	-	-	4	

ASSEMBLE ON PARTS

注：工厂用

注：工地复尺

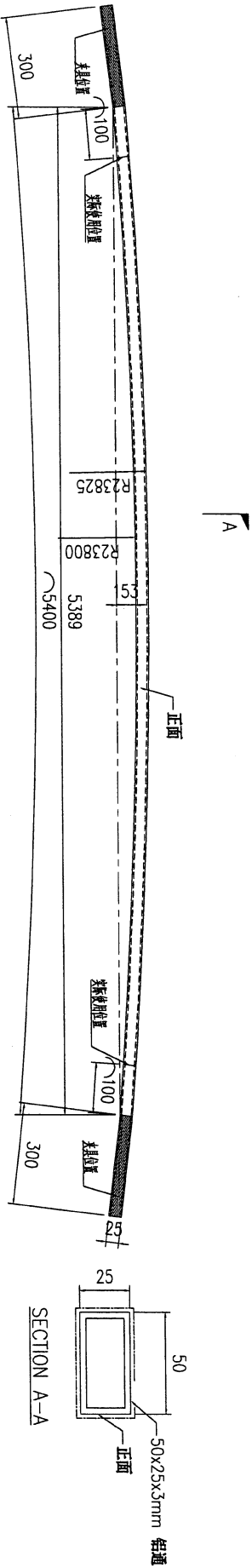

DWG. NO.

LW03-M02

REV.

SCALE

DATE  
08-03-2024

DRAWN BY

APPROVED BY

PROJECT  
YIN PING ROAD KOWLOON  
FEATURE WALL (PHASE 2)

MATERIAL  
铝通拉弯加工图

COATING  
PVF2

COLOUR  
EC-DG-D334232-ZD1

MARK. NO.  
-

QTY.  
-

CHECKED  
DWG BY

PART NUMBER  
LW03-M03

Dim. A

Dim. B

Dim. C

Dim. D

Dim. E

Dim. F

Dim. G

Dim. H

QTY.  
1

Inv. Code

ASSEMBLE ON PARTS

注：工厂用  
注：工地复尺

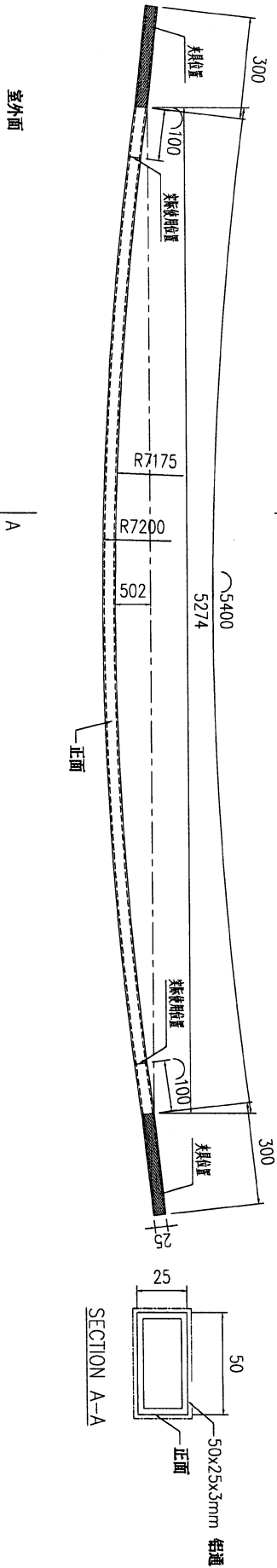

DWG. NO.

LW03-M03

REV.

SCALE

DATE  
08-03-2024

DRAWN BY

APPROVED BY

PROJECT				MATERIAL				COATING				COLOUR		MARK. NO.		QTY.	
YIN PING ROAD KOWLOON FEATURE WALL (PHASE 2)				铝通拉弯加工图				PVF2				EC-DG-D334232-ZD1		-		-	
REV.	CHANGED BY	PART NUMBER	Dim. A	Dim. B	Dim. C	Dim. D	Dim. E	Dim. F	Dim. G	Dim. H	QTY.	Inv. Code	ASSEMBLE ON PARTS				
-		LW03-M04	-	-	-	-	-	-	-	-	4						
													注: 工厂用		注: 工地复尺		

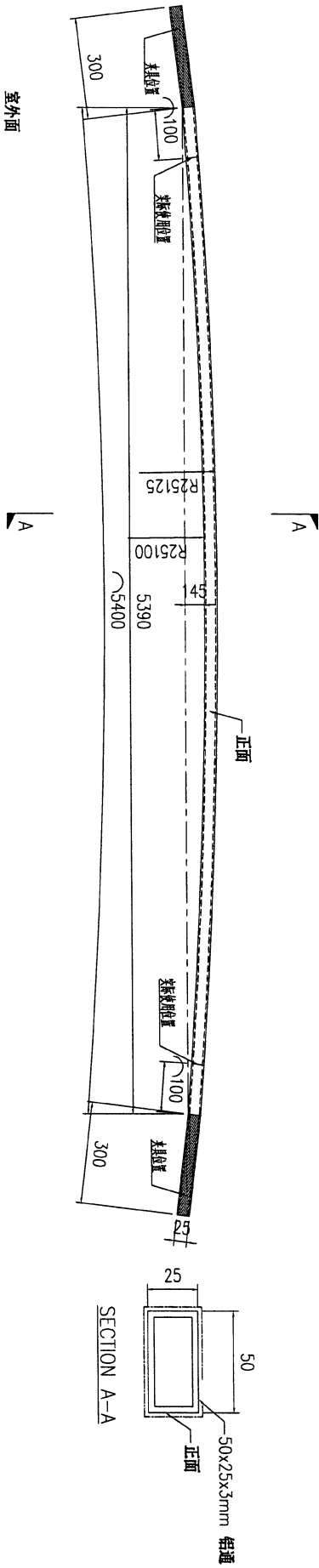

DWG. NO.		REV.		SCALE		DATE		DRAWN BY		APPROVED BY	
LW03-M04		-		-		08-03-2024		-		-	

PROJECT				MATERIAL				COATING				COLOUR		MARK. NO.		QTY.	
YIN PING ROAD KOWLOON FEATURE WALL (PHASE 2)				铝通拉弯加工图				PVF2				EC-DG-D334232-ZD1		-		-	
REV.	CHECKED DATE BY	PART NUMBER	Dim. A	Dim. B	Dim. C	Dim. D	Dim. E	Dim. F	Dim. G	Dim. H	QTY.	Inv. Code	ASSEMBLE ON PARTS				
-		LW03-M05	-	-	-	-	-	-	-	-	1						
													注: 工厂用		注: 工地复尺		

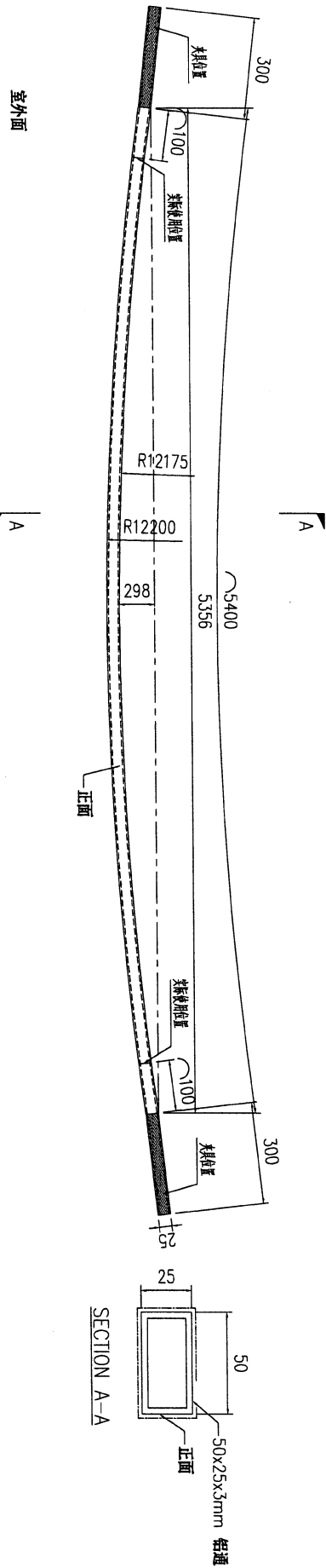

DWG. NO.		REV.		SCALE		DATE		DRAWN BY		APPROVED BY	
LW03-M05		-		-		08-03-2024		-		-	

PROJECT				MATERIAL				COATING				COLOUR		MARK. NO.		QTY.	
YIN PING ROAD KOWLOON FEATURE WALL (PHASE 2)				铝通(JMFG0078)拉弯加工图				PVF2				EC-DG-D334232-ZD1		-		-	
REV.	PART NUMBER	Dim. A	Dim. B	Dim. C	Dim. D	Dim. E	Dim. F	Dim. G	Dim. H	QTY.	Inv. Code	ASSEMBLE ON PARTS					
-	LW04-M01	-	-	-	-	-	-	-	-	4	-	注: 工厂用 注: 工地复尺					

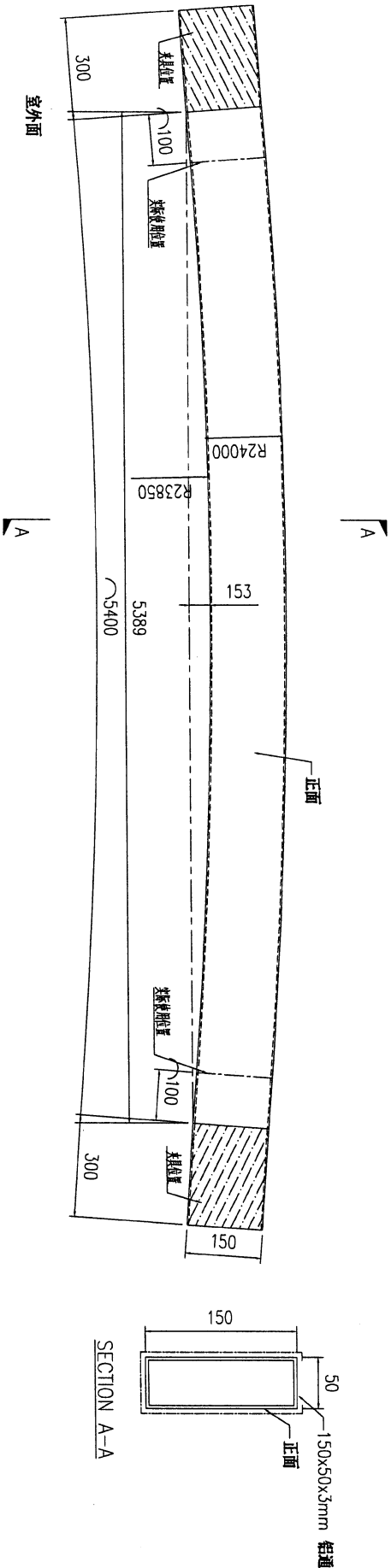

DWG. NO.		REV.		SCALE		DATE		DRAWN BY		APPROVED BY	
LW04-M01		-		-		08-03-2024		-		-	

PROJECT				MATERIAL				COATING				COLOUR				MARK. NO.		QTY.	
YIN PING ROAD KOWLOON FEATURE WALL (PHASE 2)				铝通(JMF G0078)拉弯加工图				PVF2				EC-DG-D334232-ZD1				-		-	
REV.	Checked Date by	PART NUMBER	Dim. A	Dim. B	Dim. C	Dim. D	Dim. E	Dim. F	Dim. G	Dim. H	QTY.	Inv. Code	ASSEMBLE ON PARTS						
-		LW04-M02	-	-	-	-	-	-	-	-	4								
注: 工厂用																			
注: 工地复尺																			

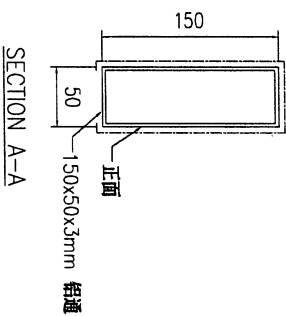
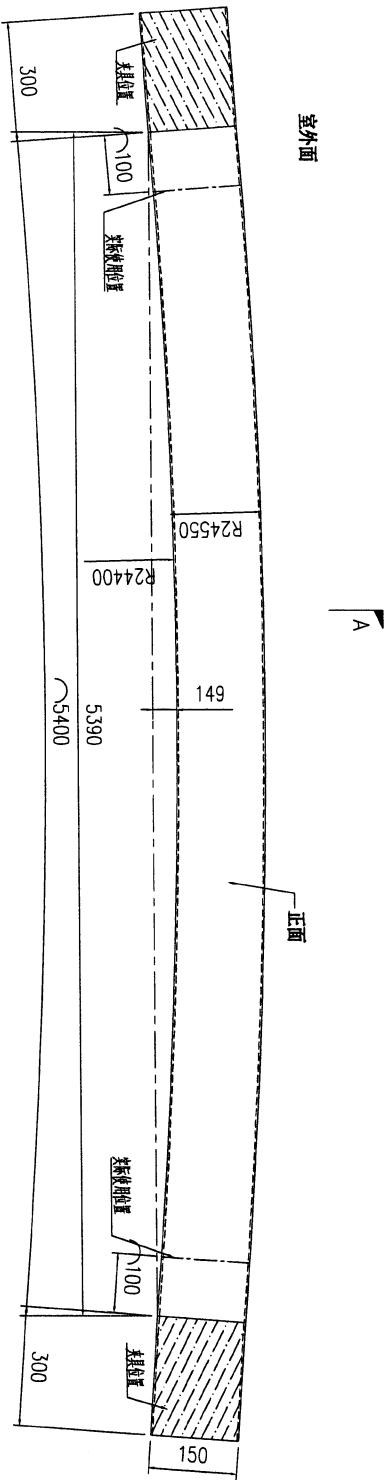

DWG. NO.		REV.		SCALE		DATE		DRAWN BY		APPROVED BY	
LW04-M02		-		-		08-03-2024		-		-	

PROJECT				MATERIAL				COATING				COLOUR		MARK. NO.		QTY.	
YIN PING ROAD KOWLOON FEATURE WALL (PHASE 2)				铝通(JMFG0078)拉弯加工图				PVF2				EC-DG-D334232-ZD1		-		-	
checked part no	PART NUMBER	Dim. A	Dim. B	Dim. C	Dim. D	Dim. E	Dim. F	Dim. G	Dim. H	QTY.	Inv. Code	ASSEMBLE ON PARTS					
-	LW04-M03	-	-	-	-	-	-	-	-	3	-						
注: 工厂用 注: 工地复尺																	

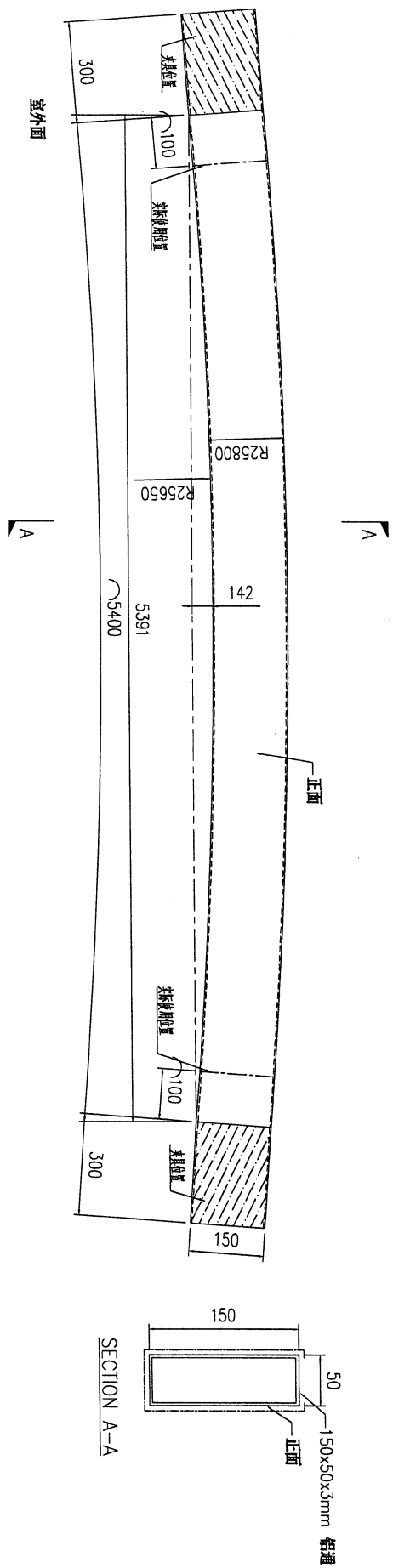

DWG. NO.	LW04-M03	REV.	-	SCALE	-	DATE	08-03-2024	DRAWN BY	-	APPROVED BY	-
----------	----------	------	---	-------	---	------	------------	----------	---	-------------	---

PROJECT  
YIN PING ROAD KOWLOON  
FEATURE WALL (PHASE 2)

MATERIAL  
铝通(JMFG0078)拉弯加工图

COATING  
PVF2

COLOUR  
EC-DG-D334232-ZD1

MARK. NO.  
-

QTY.  
-

REV.	CHECKED DATE BY	PART NUMBER	Dim. A	Dim. B	Dim. C	Dim. D	Dim. E	Dim. F	Dim. G	Dim. H	QTY.	Inv. Code
-		LW04-M04	-	-	-	-	-	-	-	-	3	

ASSEMBLE ON PARTS

注: 工厂用

注: 工地复尺

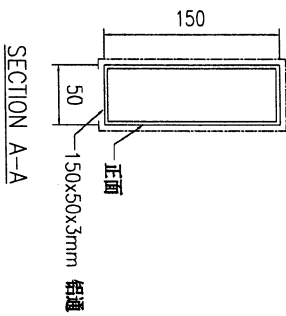
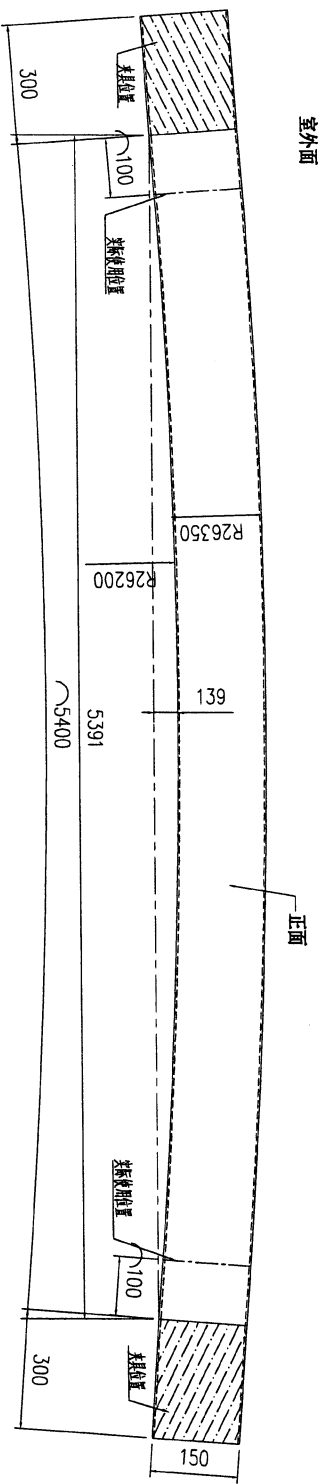

DWG. NO.	LW04-M04	REV.	-	SCALE	-	DATE	08-03-2024	DRAWN BY	-	APPROVED BY	-
----------	----------	------	---	-------	---	------	------------	----------	---	-------------	---

PROJECT				MATERIAL				COATING				COLOUR		MARK. NO.		QTY.	
YIN PING ROAD KOWLOON FEATURE WALL (PHASE 2)				铝通(JMFG0078)拉弯加工图				PVF2				EC-DG-D334232-ZD1		-		-	
REV.	PART NUMBER	Dim. A	Dim. B	Dim. C	Dim. D	Dim. E	Dim. F	Dim. G	Dim. H	QTY.	Inv. Code	ASSEMBLE ON PARTS					
-	LW04-M05	-	-	-	-	-	-	-	-	2							
注: 工厂用																	
注: 工地复尺																	

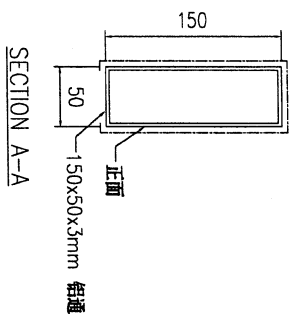
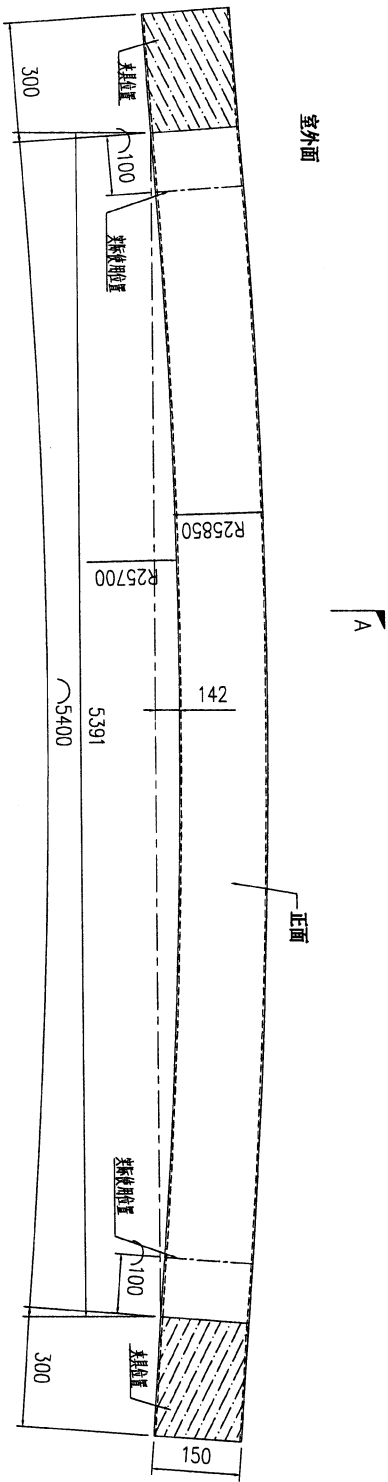

DWG. NO.		REV.		SCALE		DATE		DRAWN BY		APPROVED BY	
LW04-M05		-		-		08-03-2024		-		-	