

工程指示 / 要求簡箋 ENGINEER INSTRUCTIONS (E.I.)

工程指示編號:	EI- 7462	修改版本:	-
	HK-0458		
工程編號:	J 853	工程名稱:	延坪道 (第2期)
收件人:	生統	發件人:	Joe Chan
工程項目:	Feature Wall 項目 鋁料拉彎報價	日期:	13/03/2024

<input type="checkbox"/> 原合約工程包	<input type="checkbox"/> 原合約工程加 / 減賬 QT-	<input type="checkbox"/> 新工程報價 QT-
---------------------------------	------------------------------------------	------------------------------------

信件批核號碼/圖紙參考編號:	批核模具圖紙編號:
客戶指示附件:	管理內部批簽署:

<input type="checkbox"/> 初步鋁料 B.M.	<input type="checkbox"/> 加工拆圖, 然後生產	<input type="checkbox"/> 尺寸表
<input type="checkbox"/> 正式鋁料 B.M.	<input type="checkbox"/> 技術上資料 / 指示	<input checked="" type="checkbox"/> 報價
<input type="checkbox"/> 配件 B.M.	<input type="checkbox"/> 樣辦或貨品說明書	<input type="checkbox"/> 分判合約
<input type="checkbox"/> 其他:		

內容: 有關 EI7418A 之鋁料, 附上拉彎圖紙,
- 需拉彎之鋁料是 6063-T4, Mill料, 完成拉彎後
送噴塗。
- 請提供報價

完成上列要求日期: 20/3/2024

國內

<input type="checkbox"/> 生產技術總監	<input type="checkbox"/> 連附件	<input type="checkbox"/> 技術部	<input type="checkbox"/> 連附件	<input type="checkbox"/> 生產部	<input type="checkbox"/> 連附件
<input type="checkbox"/> 採購部	<input type="checkbox"/> 連附件	<input checked="" type="checkbox"/> 生產統籌部	<input checked="" type="checkbox"/> 連附件	<input type="checkbox"/> 報關組	<input type="checkbox"/> 連附件
<input type="checkbox"/> 質檢部	<input type="checkbox"/> 連附件	<input type="checkbox"/> 會計部	<input type="checkbox"/> 連附件	<input type="checkbox"/> 機械設計部	<input type="checkbox"/> 連附件
<input type="checkbox"/> 香港辦	<input type="checkbox"/> 連附件	<input type="checkbox"/> 其他:			

香港

<input type="checkbox"/> 行政部	<input type="checkbox"/> 連附件	<input type="checkbox"/> 會計部	<input type="checkbox"/> 連附件	<input type="checkbox"/> 統籌部	<input type="checkbox"/> 連附件	<input type="checkbox"/> 工程部	<input type="checkbox"/> 連附件
<input type="checkbox"/> 採購部	<input type="checkbox"/> 連附件	<input type="checkbox"/> QS部	<input type="checkbox"/> 連附件	<input type="checkbox"/> 地盤管理	<input type="checkbox"/> 連附件	<input type="checkbox"/> 維修部	<input type="checkbox"/> 連附件

*發件人簽署:		*組別成員批核簽署:	
傳遞編號:	HK 0458	項目經理簽署:	

PROJECT				YIN PING ROAD KOWLOON FEATURE WALL (PHASE 2)				MATERIAL				铝通拉弯加工图				COATING				PVF2				COLOUR				EC-DG-D334232-ZD1				MARK. NO.				QTY.																			
checked DWG BY				PART NUMBER				Dim. A				Dim. B				Dim. C				Dim. D				Dim. E				Dim. F				Dim. G				Dim. H				QTY.				Inv. Code				ASSEMBLE ON PARTS				注: 工厂用			
-				LM01-M01				-				-				-				-				-				-				-				-				36															

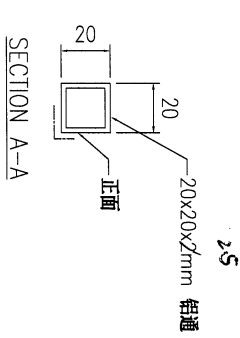
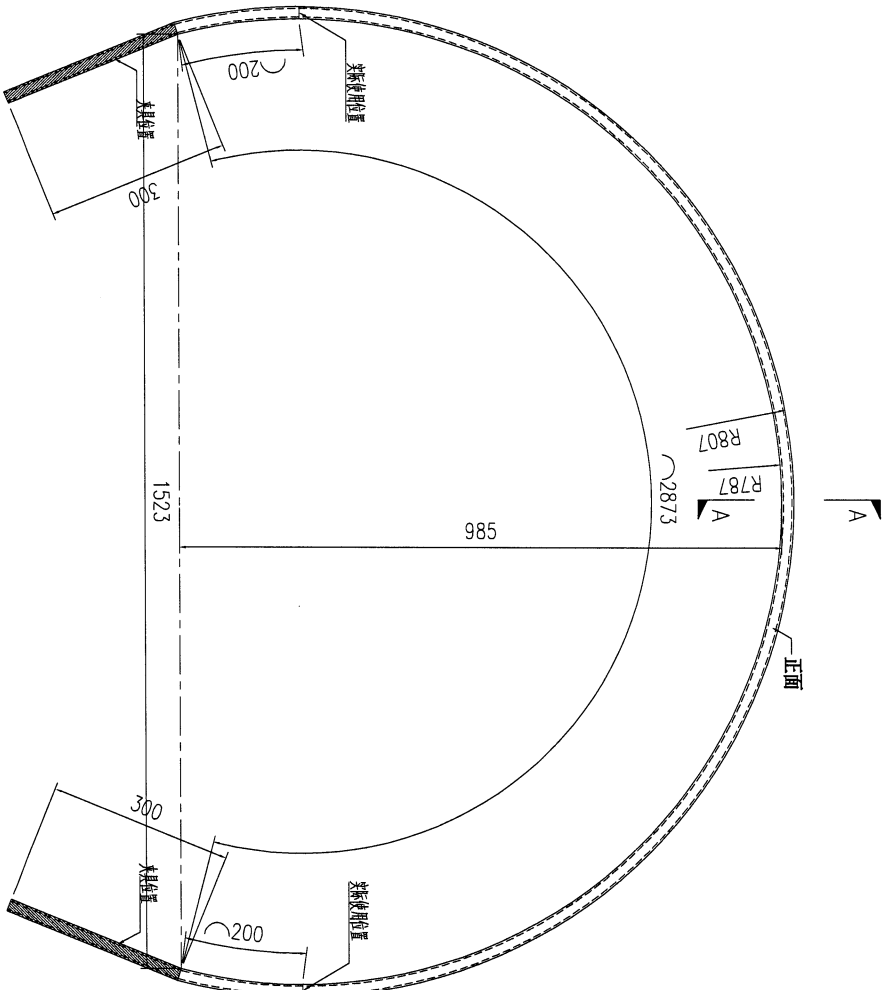

DWG. NO.		REV.		SCALE		DATE		DRAWN BY		APPROVED BY	
LM01-M01		-		-		08-03-2024		-		-	

PROJECT		YIN PING ROAD KOWLOON FEATURE WALL (PHASE 2)					MATERIAL		铝通拉弯加工图		COATING		PVF2		COLOUR		EC-DG-D334232-ZD1		MARK. NO.		QTY.	
REV.	CHECKED DATE BY	PART NUMBER	Dim. A	Dim. B	Dim. C	Dim. D	Dim. E	Dim. F	Dim. G	Dim. H	QTY.	Inv. Code	ASSEMBLE ON PARTS		注: 工厂用							
-		LW01-M02	-	-	-	-	-	-	-	-	36											

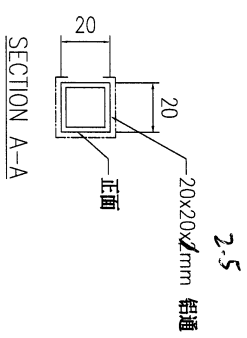
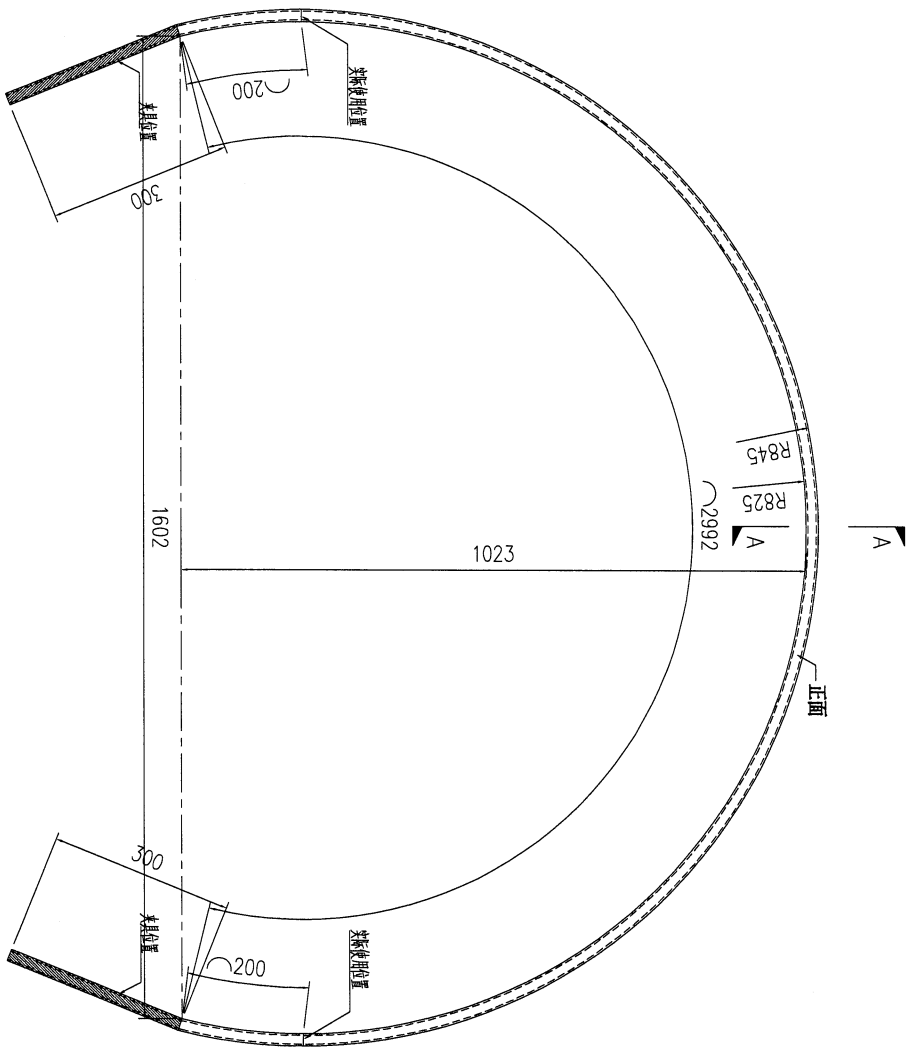

DWG. NO.		LW01-M02		REV.		SCALE		DATE		DRAWN BY		APPROVED BY	
								08-03-2024					

PROJECT		YIN PING ROAD KOWLOON FEATURE WALL (PHASE 2)				MATERIAL		铝通拉弯加工图		COATING		PVF2		COLOUR		EC-DG-D334232-ZD1		MARK. NO.		QTY.		
REV.	CREATED BY	PART NUMBER	Dim. A	Dim. B	Dim. C	Dim. D	Dim. E	Dim. F	Dim. G	Dim. H	QTY.	Inv. Code	ASSEMBLE ON PARTS		注: 工厂用							
-		LW01-M03	-	-	-	-	-	-	-	-	36											

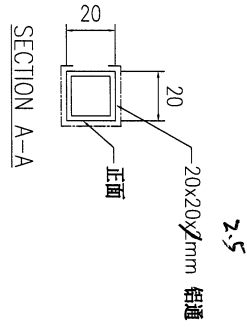
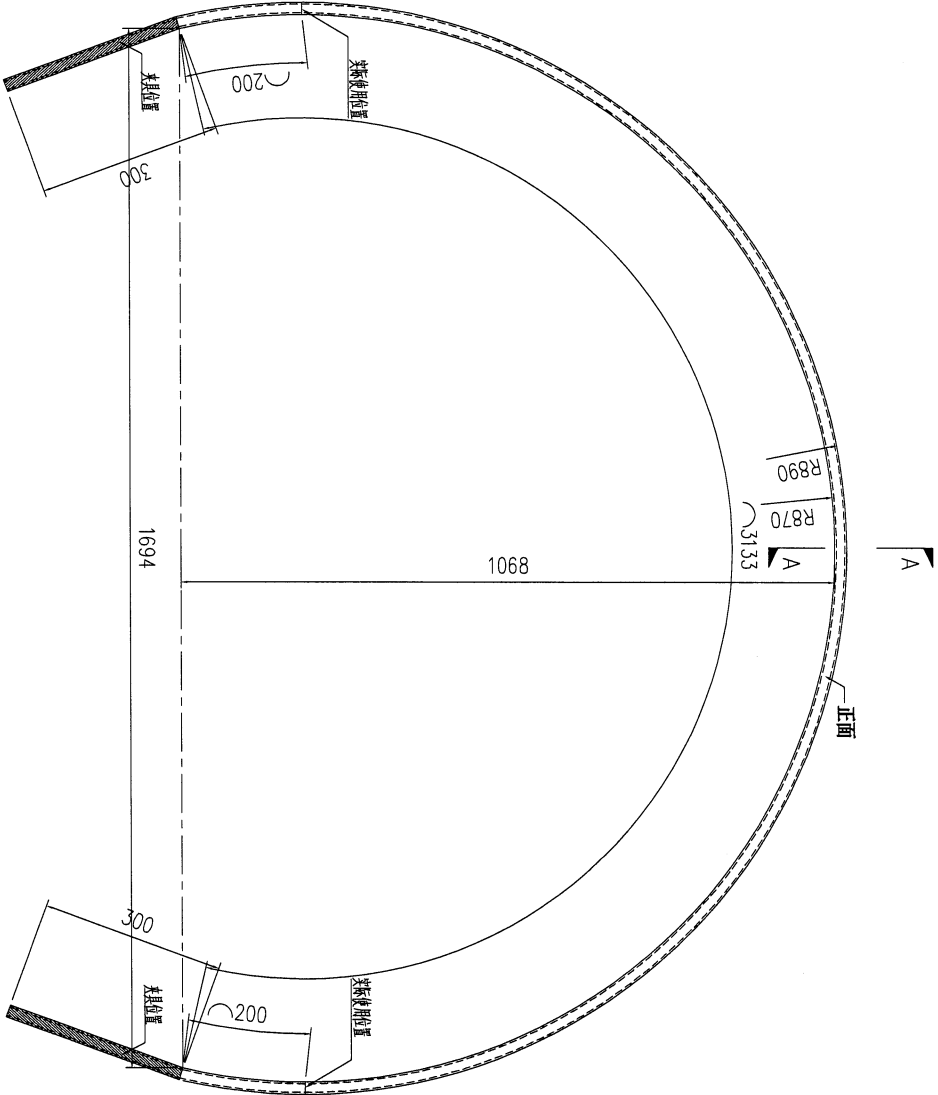

DWG. NO.		LW01-M03		REV.		SCALE		DATE		DRAWN BY		APPROVED BY	
				-		-		08-03-2024		-		-	

PROJECT		YIN PING ROAD KOWLOON FEATURE WALL (PHASE 2)				MATERIAL		铝通拉弯加工图		COATING		PVF2		COLOUR		EC-DG-D334232-ZD1		MARK. NO.		QTY.	
checked and by	PART NUMBER	Dim. A	Dim. B	Dim. C	Dim. D	Dim. E	Dim. F	Dim. G	Dim. H	QTY.	Inv. Code	ASSEMBLE ON PARTS									
-	LW01-M04	-	-	-	-	-	-	-	-	36											
												注: 工厂用									

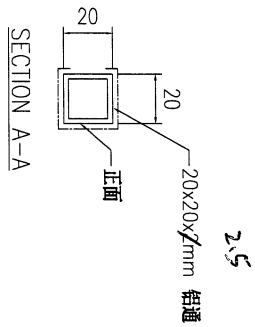
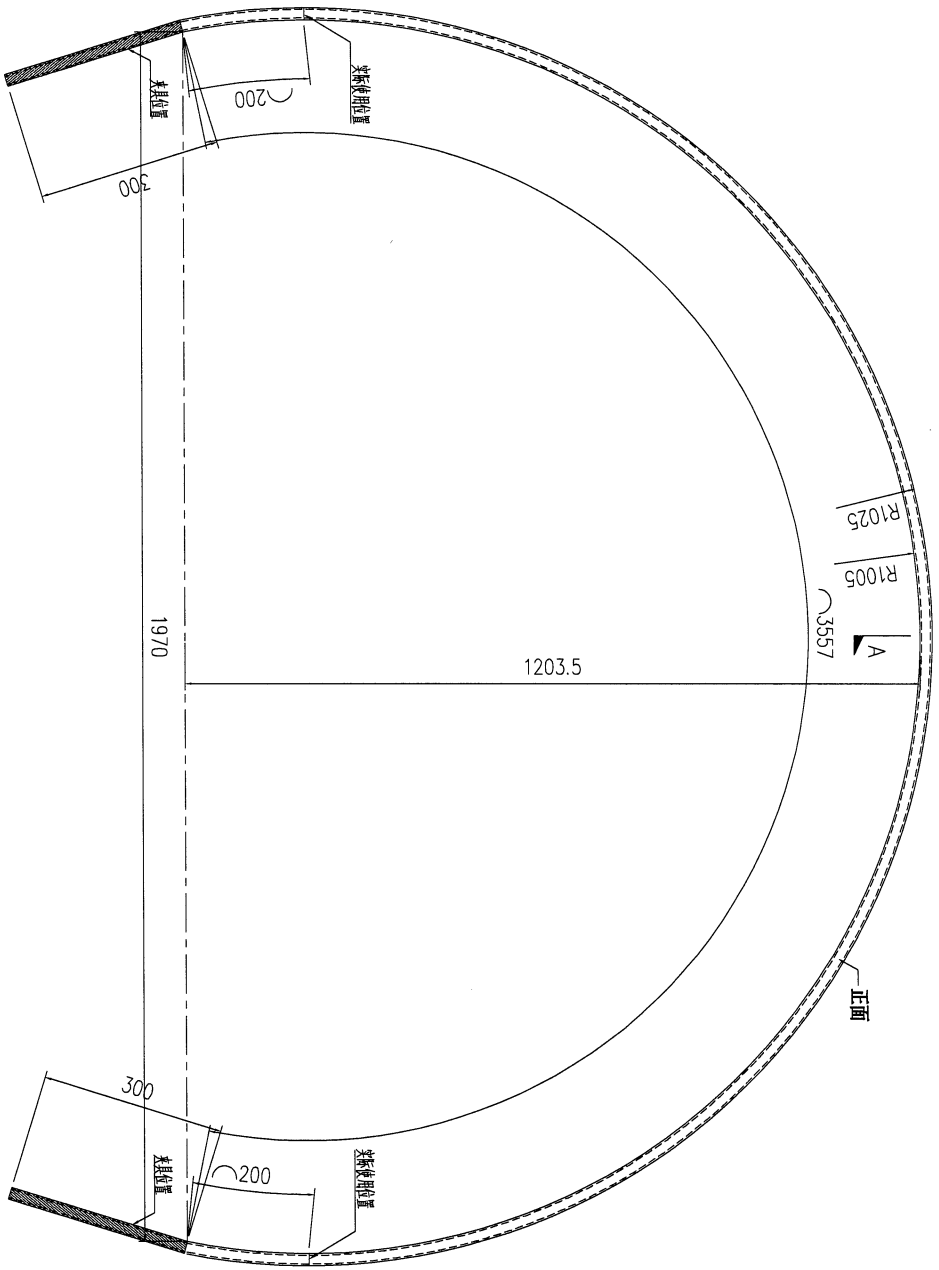

DWG. NO.	REV.	SCALE	DATE	DRAWN BY	APPROVED BY
LW01-M04	-	-	08-03-2024	-	-

PROJECT				MATERIAL				COATING				COLOUR		MARK. NO.		QTY.	
YIN PING ROAD KOWLOON FEATURE WALL (PHASE 2)				铝通拉弯加工图				PVF2				EC-DG-D334232-ZD1		-		-	
REV.	DWG. NO.	PART NUMBER	Dim. A	Dim. B	Dim. C	Dim. D	Dim. E	Dim. F	Dim. G	Dim. H	QTY.	Inv. Code	ASSEMBLE ON PARTS				
-	LW02-M01	-	-	-	-	-	-	-	-	-	2	-	注: 工厂用				
													注: 工地复尺				

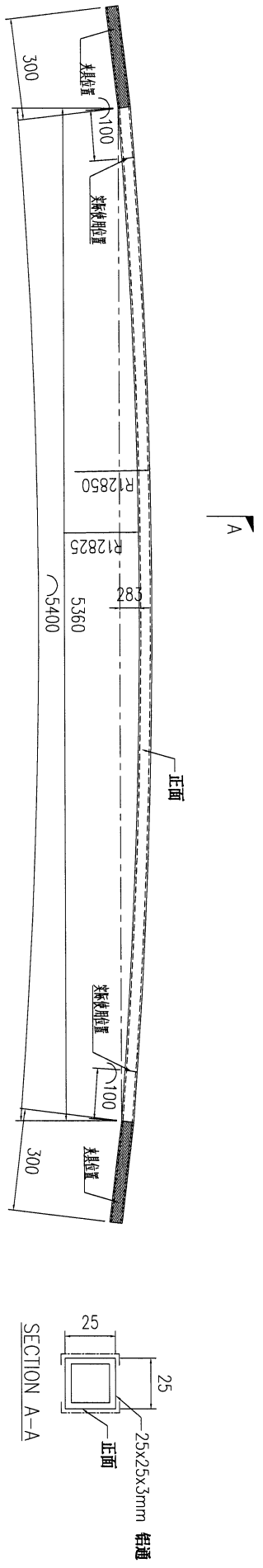

DWG. NO.	REV.	SCALE	DATE	DRAWN BY	APPROVED BY
LW01-M01	-	-	08-03-2024	-	-

PROJECT				MATERIAL				COATING				COLOUR		MARK. NO.		QTY.	
YIN PING ROAD KOWLOON FEATURE WALL (PHASE 2)				铝通拉弯加工图				PVF2				EC-DG-D334232-ZD1		-		-	
REV.	PART NUMBER	Dim. A	Dim. B	Dim. C	Dim. D	Dim. E	Dim. F	Dim. G	Dim. H	QTY.	Inv. Code	ASSEMBLE ON PARTS					
CHKD BY	LW02-M02	-	-	-	-	-	-	-	-	4	-	注: 工厂用					
												注: 工地复尺					

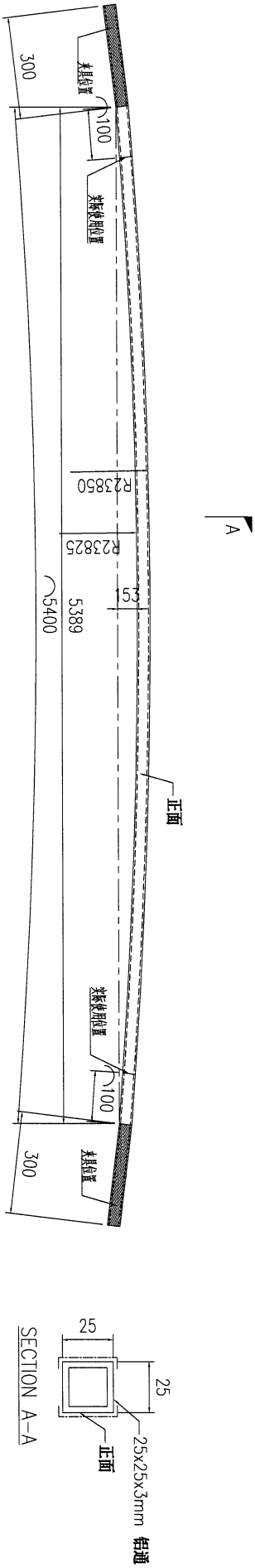

DWG. NO.		REV.		SCALE		DATE		DRAWN BY		APPROVED BY	
LW02-M02		-		-		08-03-2024		-		-	

PROJECT		YIN PING ROAD KOWLOON FEATURE WALL (PHASE 2)				MATERIAL		铝通拉弯加工图		COATING		PVF2		COLOUR		EC-DG-D334232-ZD1		MARK. NO.		-		QTY.		-	
REV.	CHANGED BY	PART NUMBER	Dim. A	Dim. B	Dim. C	Dim. D	Dim. E	Dim. F	Dim. G	Dim. H	QTY.	Inv. Code	ASSEMBLE ON PARTS												
-		LW02-M03	-	-	-	-	-	-	-	-	1														
注: 工厂用																									
注: 工地复尺																									

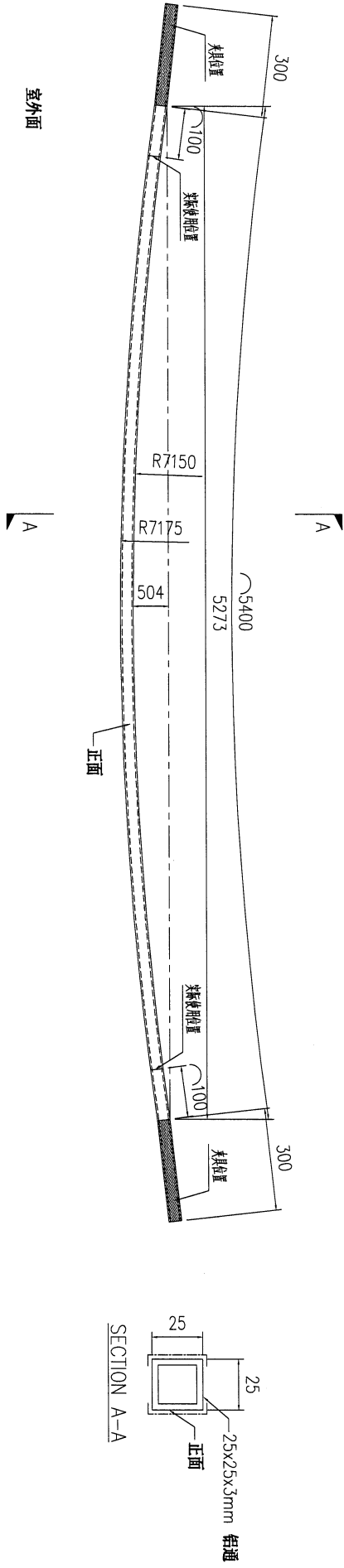

DWG. NO.		LW02-M03		REV.		-		SCALE		-		DATE		08-03-2024		DRAWN BY		-		APPROVED BY		-	
----------	--	----------	--	------	--	---	--	-------	--	---	--	------	--	------------	--	----------	--	---	--	-------------	--	---	--

PROJECT				MATERIAL				COATING				COLOUR		MARK. NO.		QTY.	
YIN PING ROAD KOWLOON FEATURE WALL (PHASE 2)				铝通拉弯加工图				PVF2				EC-DG-D334232-ZD1		-		-	
REV.	CHECKED DATE BY	PART NUMBER	Dim. A	Dim. B	Dim. C	Dim. D	Dim. E	Dim. F	Dim. G	Dim. H	QTY.	Inv. Code	ASSEMBLE ON PARTS				
-		LW02-M04	-	-	-	-	-	-	-	-	4		注: 工厂用				
													注: 工地复尺				

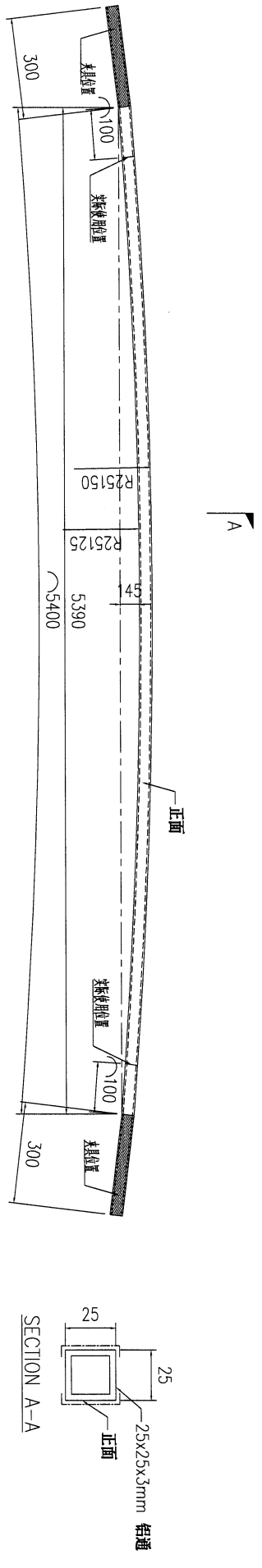

室外面

DWG. NO.		REV.		SCALE		DATE		DRAWN BY		APPROVED BY	
LW02-M04		-		-		08-03-2024		-		-	

PROJECT				MATERIAL				COATING				COLOUR		MARK. NO.		QTY.	
YIN PING ROAD KOWLOON FEATURE WALL (PHASE 2)				铝通拉弯加工图				PVF2				EC-DG-D334232-ZD1		-		-	
REV.	ORIG/REV	PART NUMBER	Dim. A	Dim. B	Dim. C	Dim. D	Dim. E	Dim. F	Dim. G	Dim. H	QTY.	Inv. Code	ASSEMBLE ON PARTS				
-		LW02-M05	-	-	-						1		注: 工厂用				
													注: 工地复尺				

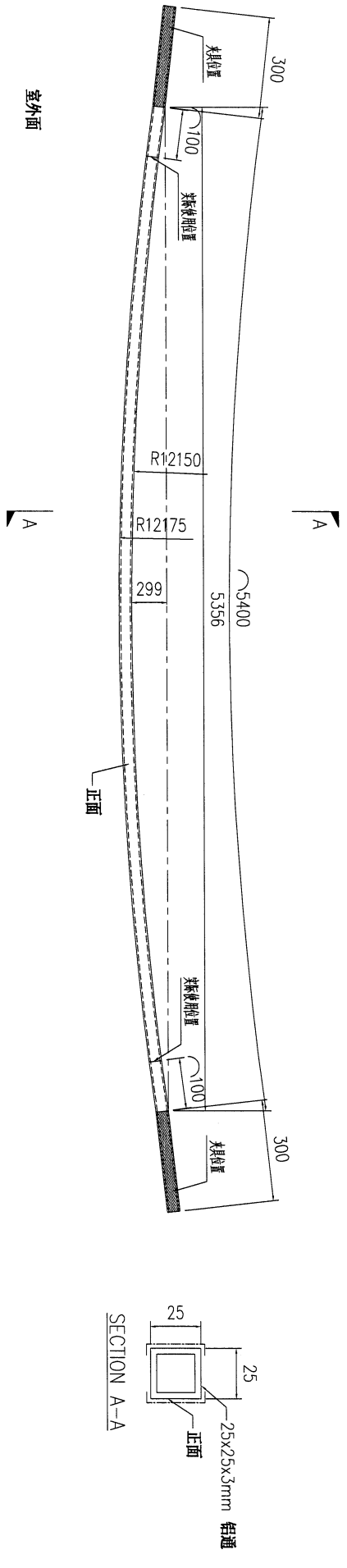

DWG. NO.		REV.		SCALE		DATE		DRAWN BY		APPROVED BY	
LW02-M05		-		-		08-03-2024		-		-	

PROJECT	YIN PING ROAD KOWLOON FEATURE WALL (PHASE 2)				MATERIAL	铝通拉弯加工图				COATING	PVF2		COLOUR	EC-DG-D334232-ZD1		MARK. NO.	-	QTY.	-
REV. / CHECKED BY	PART NUMBER	Dim. A	Dim. B	Dim. C	Dim. D	Dim. E	Dim. F	Dim. G	Dim. H	QTY.	Inv. Code	ASSEMBLE ON PARTS							
-	LW03-M01	-	-	-	-	-	-	-	-	2	-								

注：工厂用
注：工地复尺

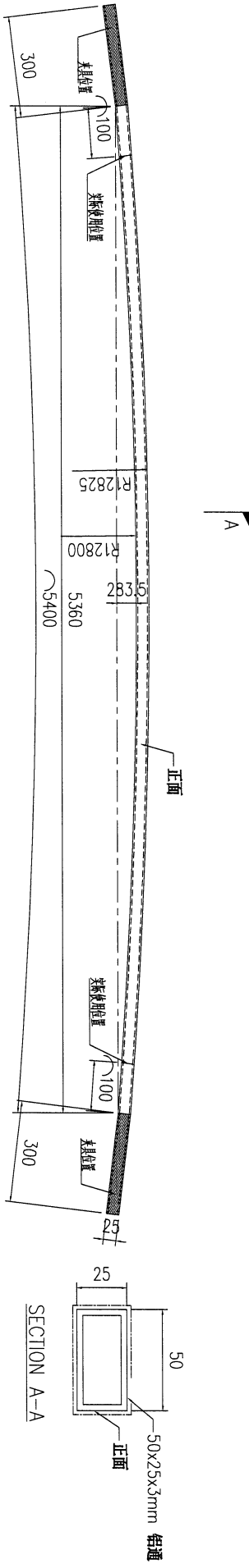

DWG. NO.	LW03-M01	REV.	-	SCALE	-	DATE	08-03-2024	DRAWN BY	-	APPROVED BY	-
----------	----------	------	---	-------	---	------	------------	----------	---	-------------	---

PROJECT		YIN PING ROAD KOWLOON FEATURE WALL (PHASE 2)				MATERIAL		铝通拉弯加工图		COATING		PVF2		COLOUR		EC-DG-D334232-ZD1		MARK. NO.		QTY.		
REV.	CHECKED DATE BY	PART NUMBER	Dim. A	Dim. B	Dim. C	Dim. D	Dim. E	Dim. F	Dim. G	Dim. H	QTY.	Inv. Code	ASSEMBLE ON PARTS									
-		LW03-M02	-	-	-	-	-	-	-	-	4											

注：工厂用
注：工地复尺

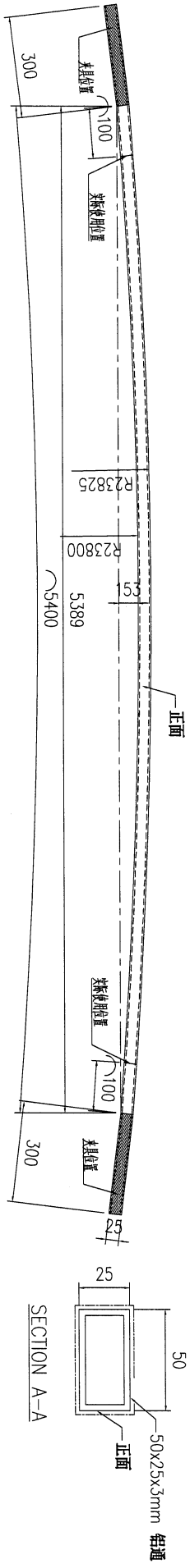

室外面

DWG. NO.		LW03-M02		REV.		-		SCALE		-		DATE		08-03-2024		DRAWN BY		-		APPROVED BY	
----------	--	----------	--	------	--	---	--	-------	--	---	--	------	--	------------	--	----------	--	---	--	-------------	--

PROJECT				MATERIAL				COATING				COLOUR		MARK. NO.		QTY.	
YIN PING ROAD KOWLOON FEATURE WALL (PHASE 2)				铝通拉弯加工图				PVF2				EC-DG-D334232-ZD1		-		-	
REV. CHECKED BY	PART NUMBER	Dim. A	Dim. B	Dim. C	Dim. D	Dim. E	Dim. F	Dim. G	Dim. H	QTY.	Inv. Code	ASSEMBLE ON PARTS					
-	LW03-M03	-	-	-	-	-	-	-	-	1	-	注: 工厂用 注: 工地复尺					

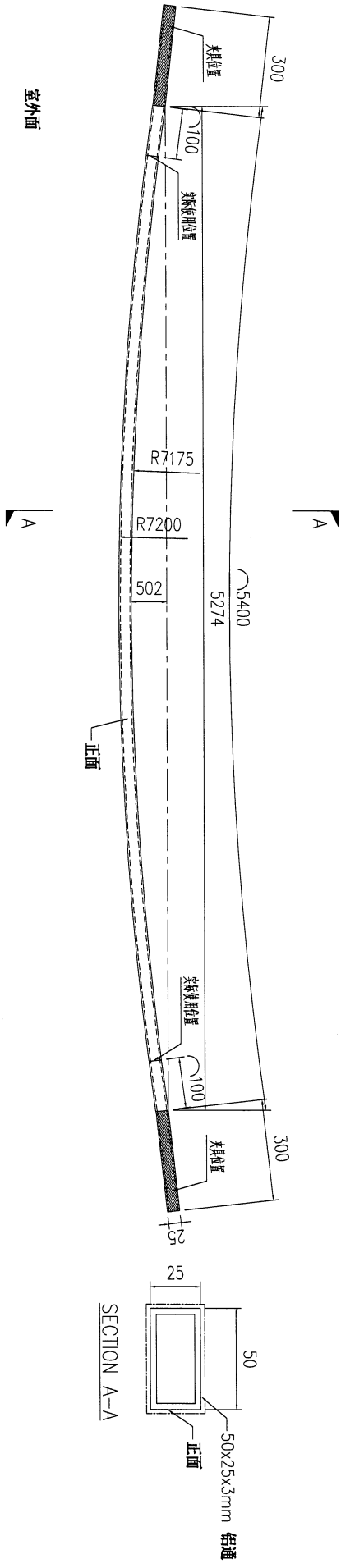

DWG. NO.		REV.		SCALE		DATE		DRAWN BY		APPROVED BY	
LW03-M03		-		-		08-03-2024		-		-	

PROJECT				MATERIAL				COATING				COLOUR		MARK. NO.		QTY.	
YIN PING ROAD KOWLOON FEATURE WALL (PHASE 2)				铝通拉弯加工图				PVF2				EC-DG-D334232-ZD1		-		-	
REV.	CHECKED DATE BY	PART NUMBER	Dim. A	Dim. B	Dim. C	Dim. D	Dim. E	Dim. F	Dim. G	Dim. H	QTY.	Inv. Code	ASSEMBLE ON PARTS				
-		LW03-M04	-	-	-	-	-	-	-	-	4						
													注: 工厂用				
													注: 工地复尺				

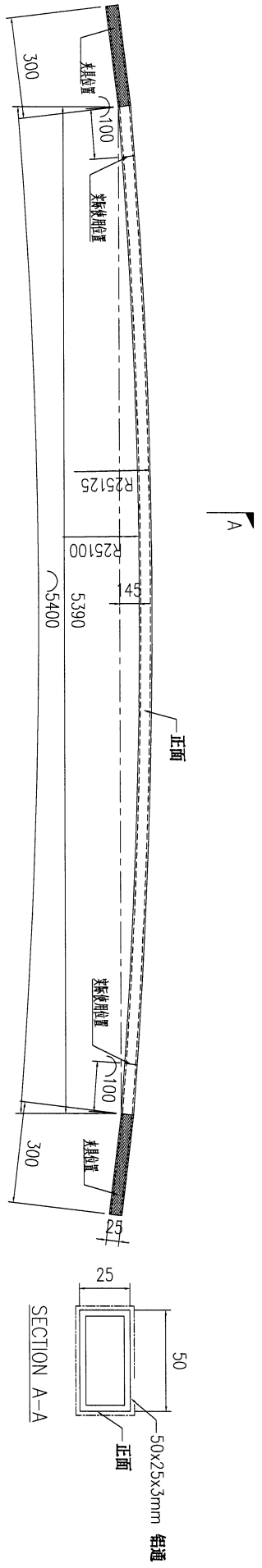

DWG. NO.		REV.		SCALE		DATE		DRAWN BY		APPROVED BY	
LW03-M04		-		-		08-03-2024		-		-	

PROJECT				MATERIAL				COATING				COLOUR		MARK. NO.		QTY.	
YIN PING ROAD KOWLOON FEATURE WALL (PHASE 2)				铝通拉弯加工图				PVF2				EC-DG-D334232-ZD1		-		-	
REV.	ORDERED DATE BY	PART NUMBER	Dim. A	Dim. B	Dim. C	Dim. D	Dim. E	Dim. F	Dim. G	Dim. H	QTY.	Inv. Code	ASSEMBLE ON PARTS				
-		LW03-M05	-	-	-						1						
													注: 工厂用				
													注: 工地复尺				

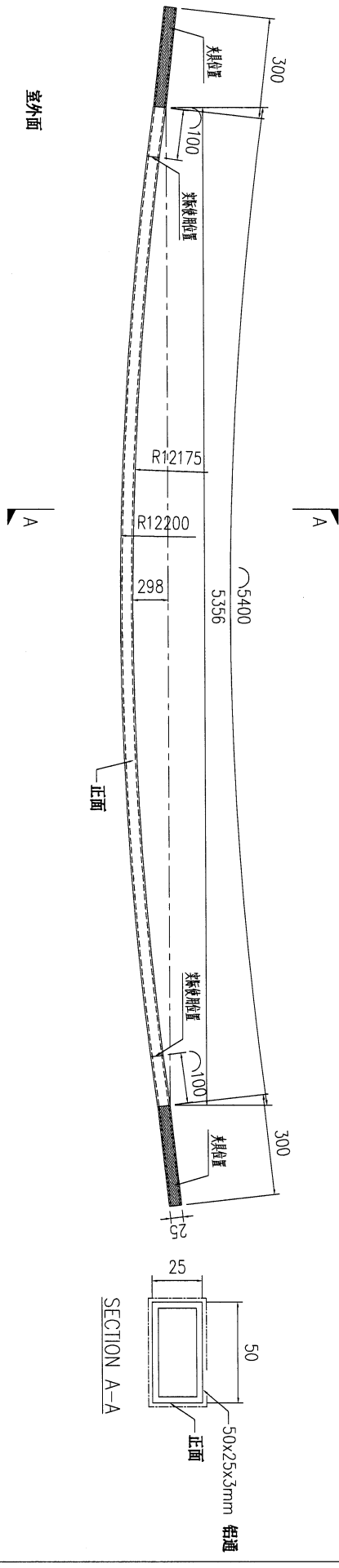

DWG. NO.		REV.		SCALE		DATE		DRAWN BY		APPROVED BY	
LW03-M05		-		-		08-03-2024		-		-	

PROJECT				MATERIAL				COATING				COLOUR		MARK. NO.		QTY.	
YIN PING ROAD KOWLOON FEATURE WALL (PHASE 2)				铝通(JMF G0078)拉弯加工图				PVF2				EC-DG-D334232-ZD1		-		-	
REV.	ORDERED BY	PART NUMBER	Dim. A	Dim. B	Dim. C	Dim. D	Dim. E	Dim. F	Dim. G	Dim. H	QTY.	Inv. Code	ASSEMBLE ON PARTS				
-		LW04-M01	-	-	-						4						
													注: 工厂用				
													注: 工地复尺				

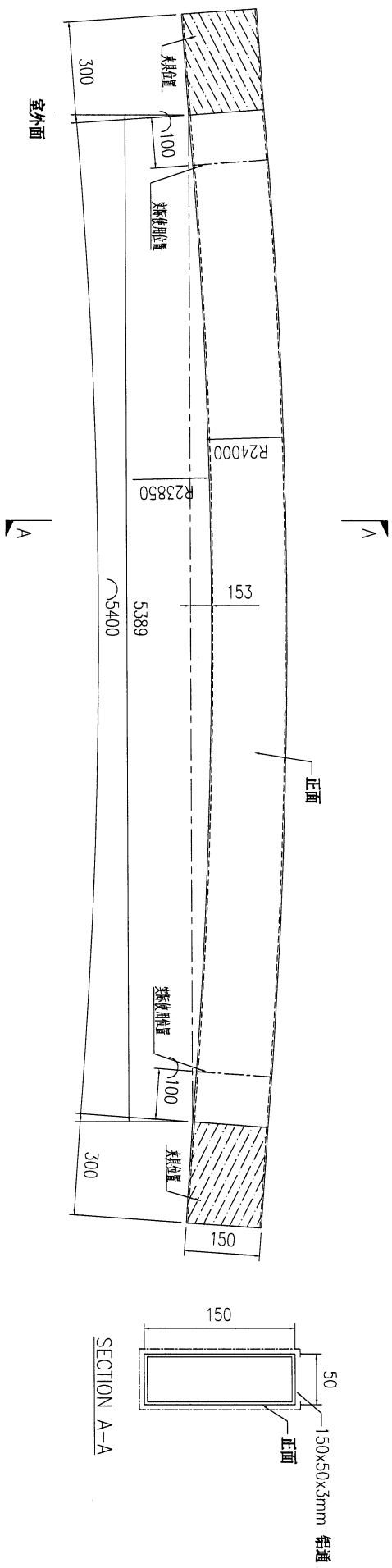

DWG. NO.		REV.		SCALE		DATE		DRAWN BY		APPROVED BY	
LW04-M01		-		-		08-03-2024		-		-	

PROJECT				MATERIAL				COATING				COLOUR		MARK. NO.		QTY.	
YIN PING ROAD KOWLOON FEATURE WALL (PHASE 2)				铝通(JMF G0078)拉弯加工图				PVF2				EC-DG-D334232-ZD1		-		-	
REV.	checked date	PART NUMBER	Dim. A	Dim. B	Dim. C	Dim. D	Dim. E	Dim. F	Dim. G	Dim. H	QTY.	Inv. Code	ASSEMBLE ON PARTS				
-		LW04-M03	-	-	-	-	-	-	-	-	3						
													注: 工厂用		注: 工地复尺		

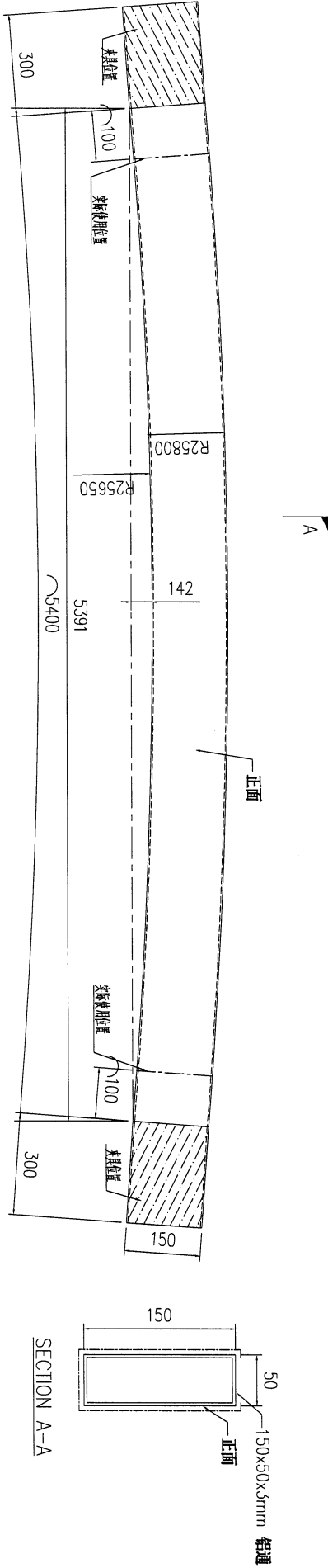

DWG. NO.		REV.		SCALE		DATE		DRAWN BY		APPROVED BY	
LW04-M03		-		-		08-03-2024		-		-	

PROJECT		YIN PING ROAD KOWLOON FEATURE WALL (PHASE 2)				MATERIAL		铝通(JMFG0078)拉弯加工图		COATING		PVF2		COLOUR		EC-DG-D334232-ZD1		MARK. NO.		QTY.	
PART NUMBER		Dim. A	Dim. B	Dim. C	Dim. D	Dim. E	Dim. F	Dim. G	Dim. H	QTY.	Inv. Code	ASSEMBLE ON PARTS									
REV. DWG BY	LW04-M04	-	-	-	-	-	-	-	-	3											

注：工厂用
注：工地复尺

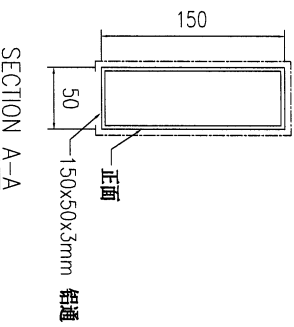
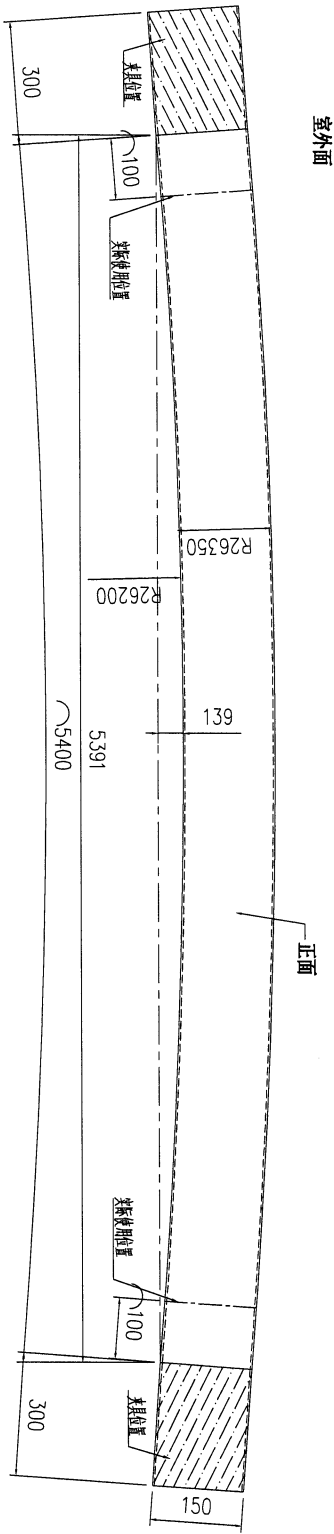

DWG. NO.	LW04-M04	REV.	-	SCALE	-	DATE	08-03-2024	DRAWN BY	-	APPROVED BY	-
----------	----------	------	---	-------	---	------	------------	----------	---	-------------	---

PROJECT				MATERIAL				COATING				COLOUR		MARK. NO.		QTY.											
YIN PING ROAD KOWLOON FEATURE WALL (PHASE 2)				铝通(JMFG0078)拉弯加工图				PVF2				EC-DG-D334232-ZD1		-		-											
CHECKED DWG BY		PART NUMBER		Dim. A		Dim. B		Dim. C		Dim. D		Dim. E		Dim. F		Dim. G		Dim. H		QTY.		Inv. Code		ASSEMBLE ON PARTS		注: 工厂用	
-		LW04-M05		-		-		-		-		-		-		-		-		2						注: 工地复尺	

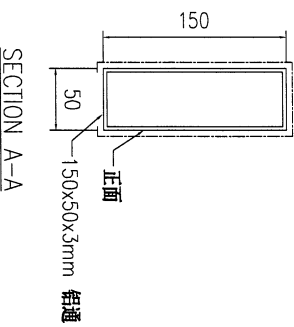
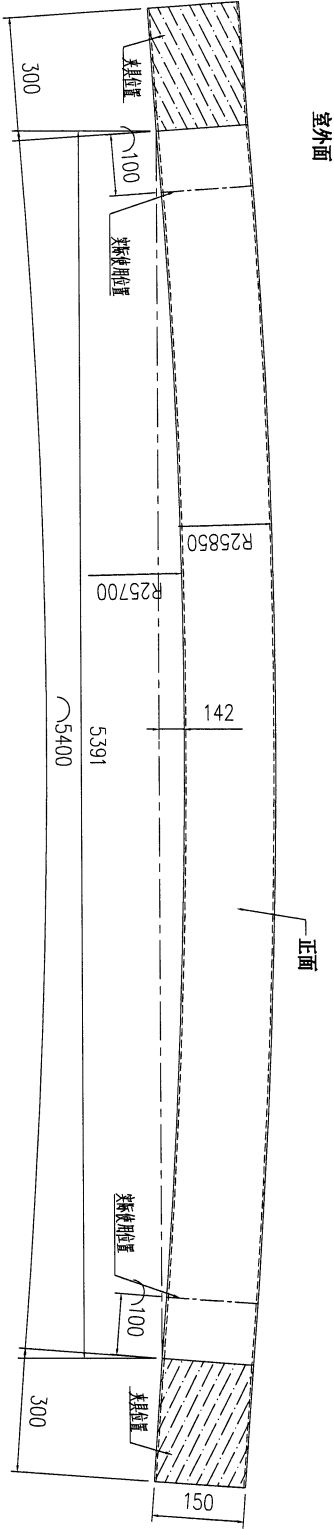

DWG. NO.		REV.		SCALE		DATE		DRAWN BY		APPROVED BY	
LW04-M05		-		-		08-03-2024		-		-	