

工程指示 / 要求簡箋(E.I.)

工程指示編號：EI / 293^Y 21

修改版次：-

工程編號：J - 852

工程名稱：亞皆老街中電

工程項目：天花鋁板 色辦 Colonial White (10 件) (AB 單位)

收件人：生統 / 板金

發件人：Ant Yeung

日期：12/01/2021

要求提供 / 確認 事項：

- | | | |
|------------------------------------|-------------------------------------|-------------------------------|
| <input type="checkbox"/> 初步鋁料 B.M. | <input type="checkbox"/> 加工拆圖，然後生產 | <input type="checkbox"/> 尺寸表 |
| <input type="checkbox"/> 正式鋁料 B.M. | <input type="checkbox"/> 技術上資料 / 指示 | <input type="checkbox"/> 報價 |
| <input type="checkbox"/> 配件 B.M. | <input type="checkbox"/> 樣辦或貨品說明書 | <input type="checkbox"/> 分判合約 |
| <input type="checkbox"/> 其他：_____ | | |

內容：

請配天花鋁板色辦 (UC54983: Colonial White) 各 5 件有孔板及無孔板，共 10 件。送寫字樓 1/F 阿源收。
有孔板: 5mm 厚; 無孔板: 3mm 厚。尺寸: 300X300. PPG 3 塗。

請在 2021.01.21 前完成上列要求。

附：2 頁

以上項目為：

- 原合約工程包 原合約工程加 / 減賬 新工程報價

原因：-

分發東莞各部門：

- | | | | |
|--------------------------------------------------------------|-----------------------------------------------------------------------------------|-------------------------------------------------------------------------|---------------------------------------------------------------------|
| <input type="checkbox"/> 生產技術總監 <input type="checkbox"/> 連附件 | <input type="checkbox"/> 技術部 <input type="checkbox"/> 連附件 | <input type="checkbox"/> 生產部 <input type="checkbox"/> 連附件 | <input type="checkbox"/> 機械設計部 <input type="checkbox"/> 連附件 |
| <input type="checkbox"/> 採購部 <input type="checkbox"/> 連附件 | <input checked="" type="checkbox"/> 生產統籌部 <input checked="" type="checkbox"/> 連附件 | <input checked="" type="checkbox"/> 小羅 & 清 <input type="checkbox"/> 連附件 | |
| <input type="checkbox"/> 質檢部 <input type="checkbox"/> 連附件 | <input type="checkbox"/> 會計部 <input type="checkbox"/> 連附件 | <input type="checkbox"/> 報關組 <input type="checkbox"/> 連附件 | <input type="checkbox"/> 其他 <u>楊榮輝</u> <input type="checkbox"/> 連附件 |

分發其他分判：

- (v) 水洪 連附件

分發香港各部門：

- | | | | |
|-----------------------------------------------------------|------------------------------------------------------------|-----------------------------------------------------------|----------------------------------------------------------------|
| <input type="checkbox"/> 行政部 <input type="checkbox"/> 連附件 | <input type="checkbox"/> 會計部 <input type="checkbox"/> 連附件 | <input type="checkbox"/> 統籌部 <input type="checkbox"/> 連附件 | <input type="checkbox"/> 工程部地盤科文 <input type="checkbox"/> 連附件 |
| <input type="checkbox"/> 採購部 <input type="checkbox"/> 連附件 | <input type="checkbox"/> QS 部 <input type="checkbox"/> 連附件 | <input type="checkbox"/> 維修部 <input type="checkbox"/> 連附件 | <input type="checkbox"/> 其他 _____ <input type="checkbox"/> 連附件 |

傳遞編號：

HK 0088 / 21

發件人簽署： 

項目經理簽署： 



美特鋁質有限公司
MIDI Aluminium Fabricator Ltd.

序號	物料編號	數量	使用位置	樓層
1	360-4303-L1-05 375	21	J852-SD-ALC-4303	T3/(3F, 5F)

工程號	J-852	地盤	亞答老街/天花
-----	-------	----	---------

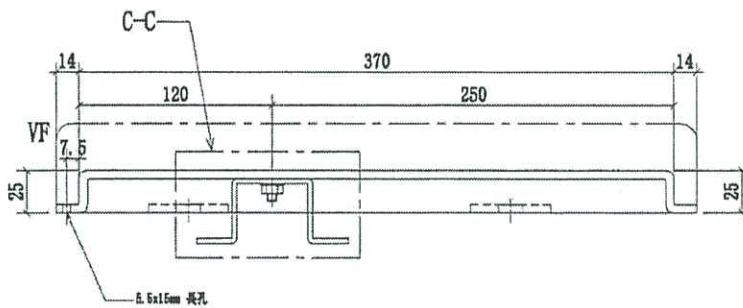
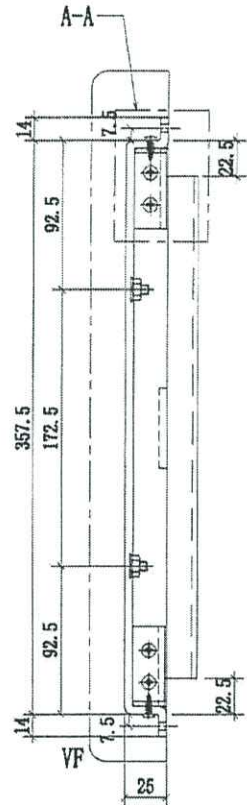
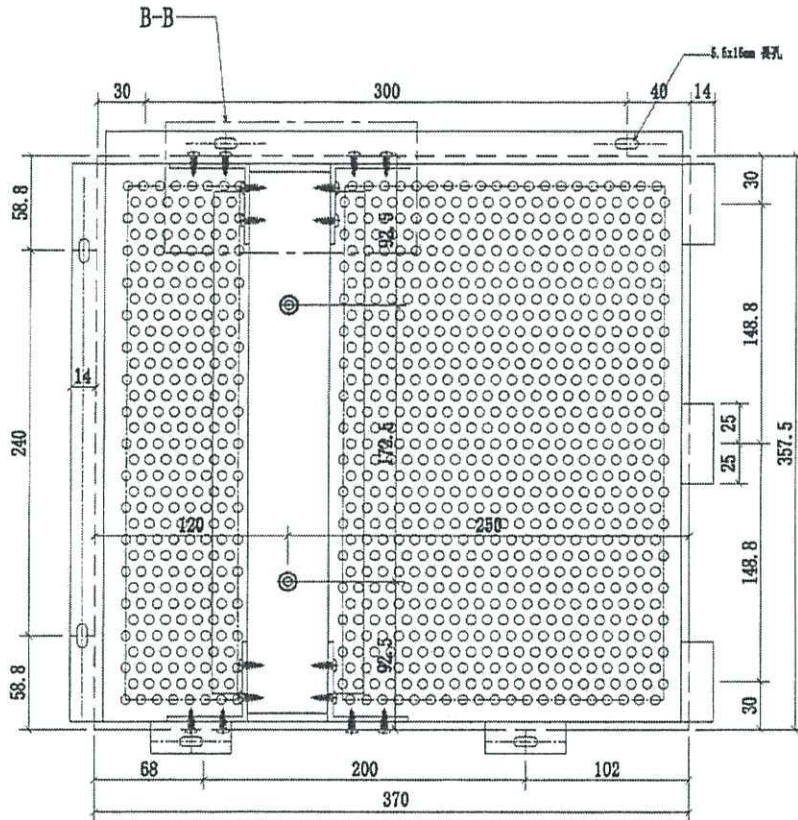

有孔板
(參考用)
A B A L

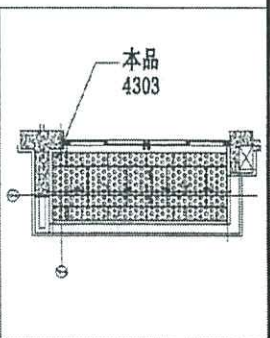
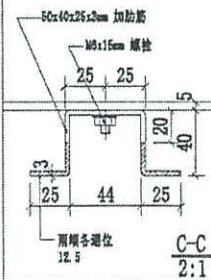
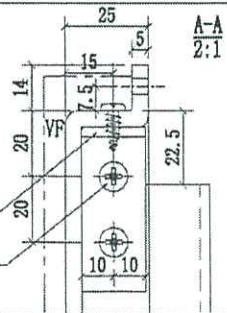
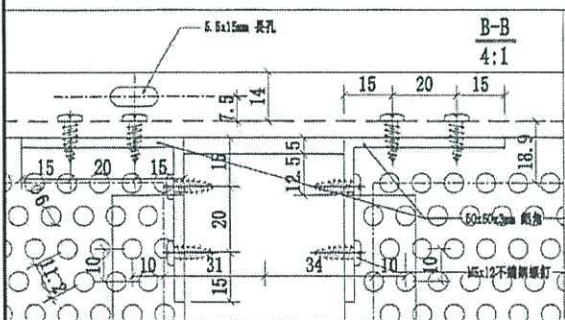

名稱	4303天花鋁板加工圖	制圖	CJM	2020.10.15	修改	
材料	✓ 5mm 厚穿孔鋁板	復核	SHUI	2020.10.20	日期	
顏色	UCT201498X1(A)=3 銀	批准			圖號	375-4303-L1-05 ✕

DURANAR® COATINGS (2-COAT SYSTEM)



UC43350 Bone White



UC51825 Fashion Gray



UC45392 Sandstone



UC54434 Aged Copper



UC54983 Colonial White



UC43352 Colonial Gray



UC54137 Beige



UC56785 Rosewood



UC54412 Ivory



UC54271 Charcoal Gray



UC45082 Sage Brown



UC56729 Coral



UC45074 Seawolf



UC40577 Black



UC43347 Statuary Bronze



UC43355 Brick Red

The DURANAR color chips provided in our color guide are as close as possible to the DURANAR paint color, however color chip reproduction has limitations. Panels of the actual DURANAR finish are available upon request. The color guide represents the range of available colors, but custom color matches are available within the limits of durable color pigments.

DURANAR EXOTIC COATINGS (2-COAT SYSTEM)



UC43359 Colonial Blue



UC50014 Interstate Blue



UC51524 Interstate Green



UC52006 River Rouge Red



UC51130 Blue



UC52064 Arabian Blue



UC52026 Dark Green



UC52003 Boysenberry



UC51704 Night Horizon Blue



UC52128 Cherokee Blue



UC51733 Hartford Green



UC50927 Commerce Brown

Exotic Colors: These colors carry a surcharge due to their exotic pigmentation; therefore, premium pricing is applicable. Certain exotic colors may also require a barrier coat and/or the XL clear coat.