

工程指示 / 要求簡箋(E.I.)

工程指示編號：EI / 2132 / 20

修改版次：-

工程編號：J - 852

工程名稱：亞皆老街中電

工程項目：幕牆- 鋁模生產 ( 9 個 ) (X85825-X85833, 85836, 85837)

收件人：Maggie / 生統

發件人：Ant Yeung

日期：15/07/2020

要求提供 /  確認 事項：

- |                                    |                                     |                               |
|------------------------------------|-------------------------------------|-------------------------------|
| <input type="checkbox"/> 初步鋁料 B.M. | <input type="checkbox"/> 加工拆圖，然後生產  | <input type="checkbox"/> 尺寸表  |
| <input type="checkbox"/> 正式鋁料 B.M. | <input type="checkbox"/> 技術上資料 / 指示 | <input type="checkbox"/> 報價   |
| <input type="checkbox"/> 配件 B.M.   | <input type="checkbox"/> 樣辦或貨品說明書   | <input type="checkbox"/> 分判合約 |

內容：

請按加工模圖共 11 個作生產幕牆鋁模用。

AL-14(0)= A10000035

按榮陽建議修改 X85826 X85833

X85827 X85832

X85837

由 X85837 會修螺絲，預留螺絲(改短)

請在 2020 / 07 / 31 前完成上列要求。

附：1 + 11 頁

以上項目為：

- 原合約工程包                       原合約工程加 / 減賬                       新工程報價

原因：-

分發東莞各部門：

- ( ) 生產技術總監  連附件    ( ) 技術部     連附件    ( ) 生產部     連附件    ( ) 機械設計部  連附件  
 ( ) 採購部     連附件    ( ) 生產統籌部  連附件  
 ( ) 質檢部     連附件    ( ) 會計部     連附件    ( ) 報關組     連附件    ( ) 其他 楊榮輝  連附件

分發其他分判：

- (v) 水洪  連附件

分發香港各部門：

- ( ) 行政部  連附件    ( ) 會計部  連附件    ( ) 統籌部  連附件    ( ) 工程部地盤科文  連附件  
 ( ) 採購部  連附件    ( ) QS 部  連附件    ( ) 維修部  連附件    ( ) 其他 \_\_\_\_\_  連附件

傳遞編號：

HK 1433 / 20

發件人簽署：

項目經理簽署：

Aluminium Die for J852 CURTAIN WALL

| Item | Die no. (midi) | Die no. ( ) | Member no. | Grade              | 畫模圖EI1872 |   |   |   |   |   |   |   | 開模 EI 2132 |   |   |   |   |   | Remark |   |   |  |              |
|------|----------------|-------------|------------|--------------------|-----------|---|---|---|---|---|---|---|------------|---|---|---|---|---|--------|---|---|--|--------------|
|      |                |             |            |                    | 0         | A | B | C | D | E | F | G | H          | 0 | A | B | C | D |        | E | F |  |              |
| 1    | X85825         | LH0091432   | AL-01      | 6063 T6            | v         | v | v |   |   |   |   |   |            |   | 1 |   |   |   |        |   |   |  |              |
| 3    | X85826         | LH0091433   | AL-03      | 6063 T6            | v         | v | v |   |   |   |   |   |            |   | 1 |   |   |   |        |   |   |  |              |
| 2    | X85827         | LH0091436   | AL-04      | 6063 T6            | v         | v | v |   |   |   |   |   |            |   | 1 |   |   |   |        |   |   |  |              |
| 4    | X85828         | LH0091439   | AL-FD04    | 6063 T6            | v         | v | v |   |   |   |   |   |            |   | 1 |   |   |   |        |   |   |  | FD門用         |
| 5    | X85829         | LH0091440   | AL-11      | 6061 T6            | v         | v | v |   |   |   |   |   |            |   | 1 |   |   |   |        |   |   |  |              |
| 6    | X85830         | LH0091441   | AL-12      | 6061 T6            | v         | v | v |   |   |   |   |   |            |   | 1 |   |   |   |        |   |   |  |              |
| 7    | X85831         | LH0091442   | AL-13      | 6061 T6            | v         | v | v |   |   |   |   |   |            |   | 1 |   |   |   |        |   |   |  |              |
| 8    | X85832         | LH0091437   | AL-38(0)   | 6063 T6            | v         | v | v |   |   |   |   |   |            |   | 1 |   |   |   |        |   |   |  |              |
| 9    | X85833         | LH0091434   | AL-39(0)   | 6063 T6            | v         | v | v |   |   |   |   |   |            |   | 1 |   |   |   |        |   |   |  |              |
| 10   | X85835         | old die     | AL-14(0)   | <del>6063 T6</del> | v         | v | v |   |   |   |   |   |            |   |   |   |   |   |        |   |   |  | 用A10000035代替 |
| 11   | X85836         | LH0091536   | AL-41      | 6063 T6            | v         | v | v |   |   |   |   |   |            |   |   |   |   |   |        |   |   |  | 幕牆鋁疋         |
| 12   | X85837         | LH0091537   | AL-42      | 6063 T6            | v         | v | v |   |   |   |   |   |            |   |   |   |   |   |        |   |   |  | 幕牆鋁疋         |

2132  
433

此处开口过窄，容易变形，建议修改

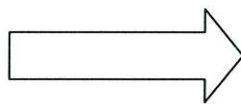
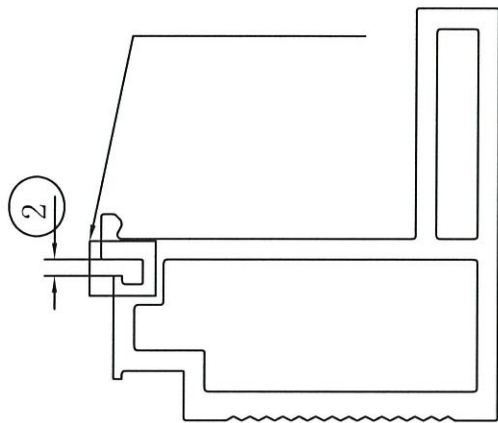

X85826  
LH0091433

建议修改如右图所示 ✓

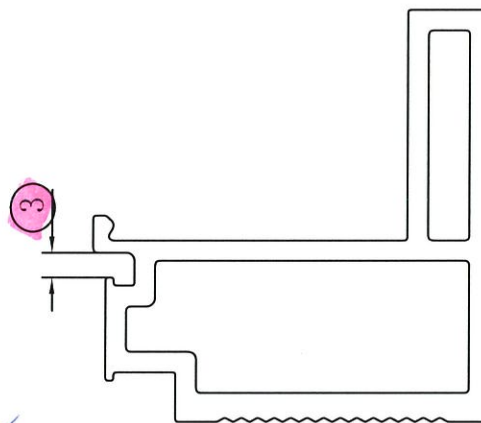

OK

为了与X85826配合，建议修改

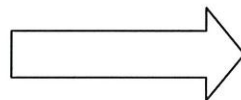
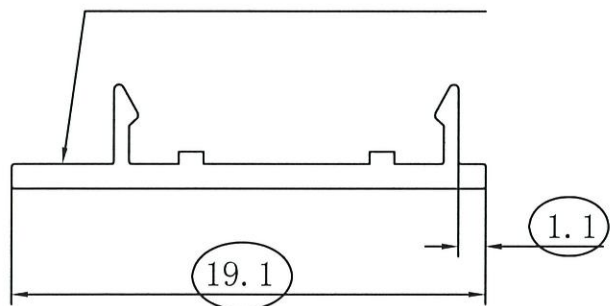

X85833  
LH0091434

建议修改如右图所示 ✓

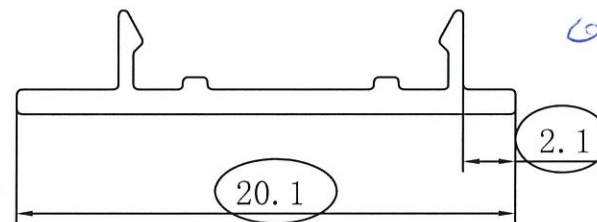

OK

此处开口过窄，容易变形，建议修改

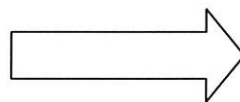
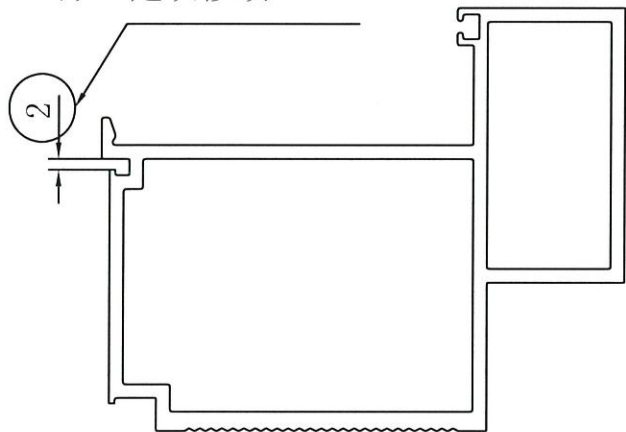

X85827  
LH0091436

建议修改如右图所示

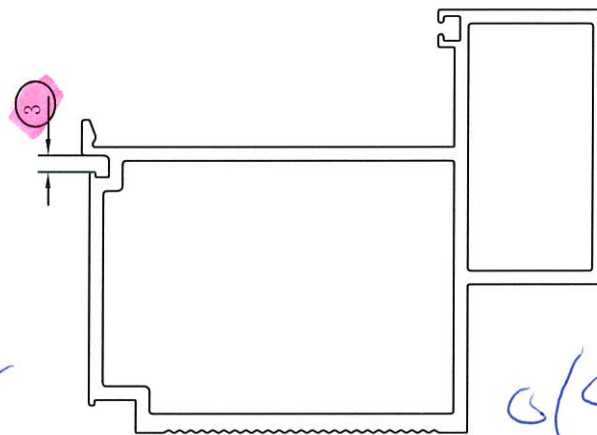

为了与X85827配合，建议修改

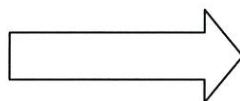
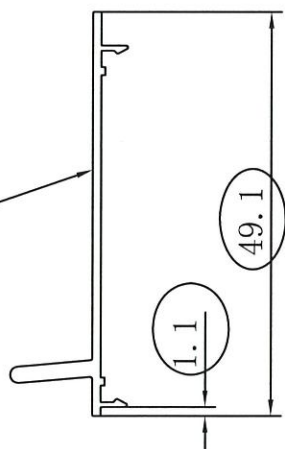

X85832  
LH0091437

建议修改如右图所示

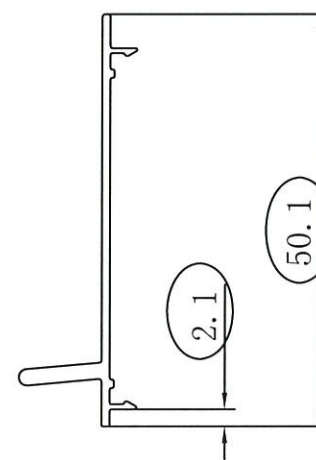

此两处深并且窄，不能  
做模，建议修改尺寸  
12mm为3.0mm，如右图

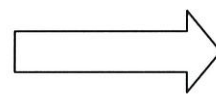
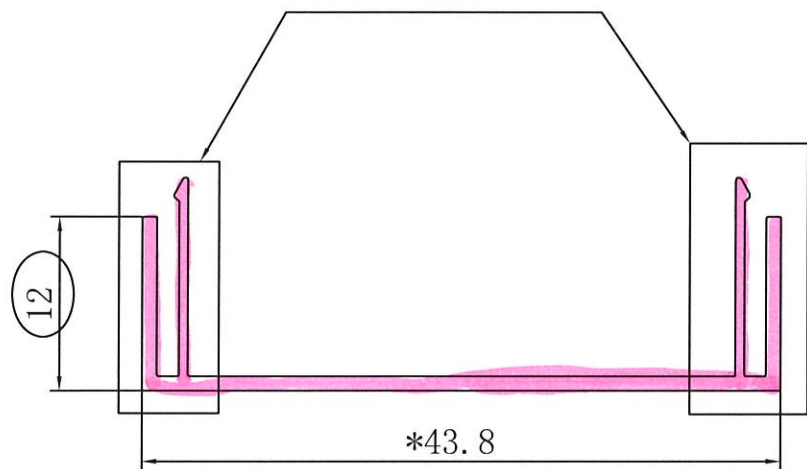

X85837  
LH0091537

建议修改如右图所示

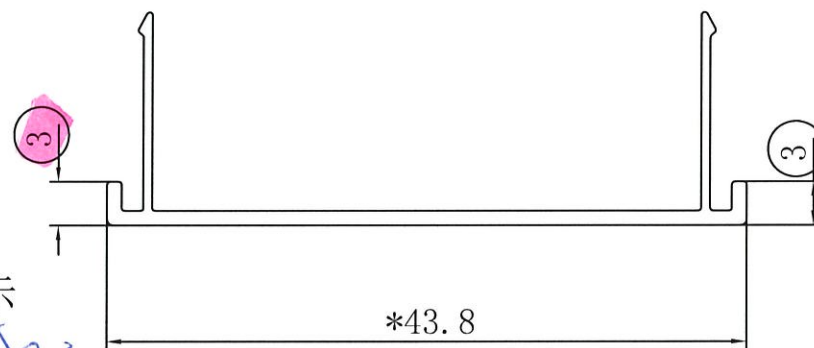

|          |              |                   |               |           |
|----------|--------------|-------------------|---------------|-----------|
| CUSTOMER | HONGKONG CO. | CUSTOMER APPROVAL | CUST PART NO. | X85825    |
|          |              |                   | SECTION NO.   | LH0091432 |

AL-01

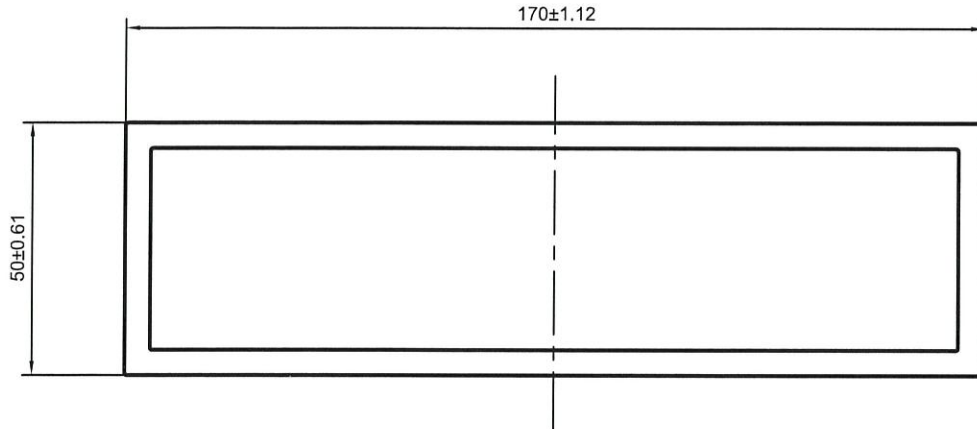

|          |                    |
|----------|--------------------|
| 美特鋁質有限公司 |                    |
| 承認圖面     | <i>[Signature]</i> |
| 日期       | 16-7-20            |

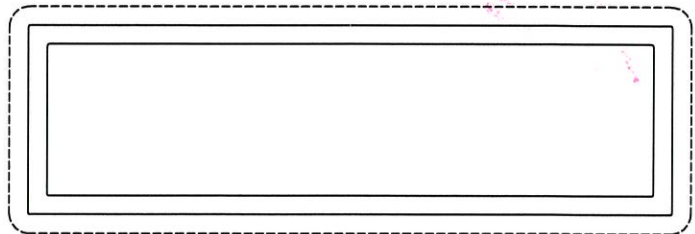

V.F

*[Signature]*

\*配合尺寸以实物配合效果为准!

SCALE 1:2

|                    |                         |                       |                 |                |        |            |             |         |         |  |
|--------------------|-------------------------|-----------------------|-----------------|----------------|--------|------------|-------------|---------|---------|--|
| SIGNATURE GRADEING | HIGH SIGNATURE GRADEING | C.C.DIA(MM)           | Ø176.96         |                |        |            | 喷涂收费周长(mm): |         | 439.14  |  |
| AREA (SQ MM)       | 2100                    | UNSPECIFIED THICKNESS | 5±0.3           | PERIMETER (MM) | 439.14 | STANDARD   | BS EN755    | SCALE   | 1:1.5   |  |
| MASS (KG/M)        | 5.691                   | UNSPECIFIED CORNERS   | R 0.5           | SURFACE AREA   | 439.14 | ALLOY      | 6063-T6     | VERSION | A       |  |
| COMPANY ISSUE      |                         | A                     | DRAWN           | 陈晓舒            | DATE   | 2020-06-08 | APPELLATION | -       | PAGE OF |  |
|                    |                         |                       | STANDARDIZATION |                | DATE   |            |             |         |         |  |
|                    |                         |                       | TO SIGN         | 王添明            | DATE   |            |             |         |         |  |
|                    |                         |                       | AUDITING        |                | DATE   |            |             |         |         |  |
| MARKER             | MODIFY                  | FILE NO               | SIGNATURE       | DATE           | APPROV | DATE       |             |         |         |  |



PANASIA ALUMINUM (CHINA) LIMITED

|          |              |                   |        |               |           |
|----------|--------------|-------------------|--------|---------------|-----------|
| CUSTOMER | HONGKONG CO. | CUSTOMER APPROVAL | (5833) | CUST PART NO. | X85826    |
|          |              |                   |        | SECTION NO.   | LH0091433 |

AL103

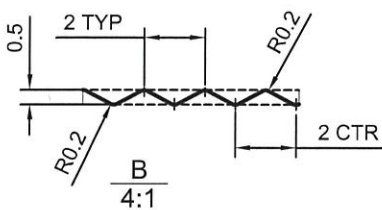
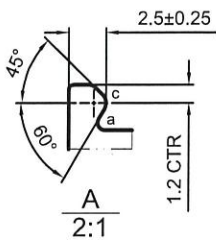
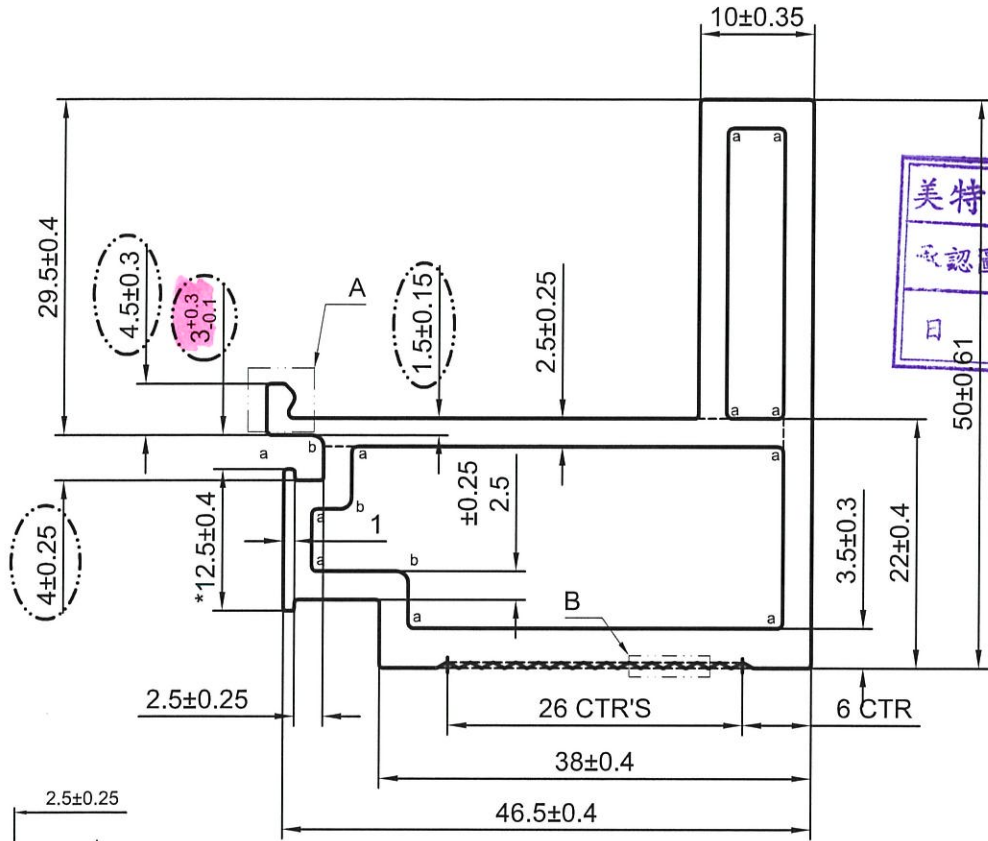

LH0091434  
X85833

a=R0.5    b=R1    c=R0.8  
 ----- 次要装饰面, 喷涂膜厚不足, 但不露底  
 ----- 装饰面  
 ●●●●●● 凹槽位置可能会有露底现象, 即膜厚不足  
 \*配合尺寸以实物配合效果为准!

V.F.  
SCALE 1:1

|                    |                         |                       |                 |                |        |            |             |         |         |  |
|--------------------|-------------------------|-----------------------|-----------------|----------------|--------|------------|-------------|---------|---------|--|
| SIGNATURE GRADEING | HIGH SIGNATURE GRADEING | C.C.DIA(MM)           | Ø 64.84         |                |        |            | 喷涂收费周长(mm): |         | 128.29  |  |
| AREA (SQ MM)       | 512.24                  | UNSPECIFIED THICKNESS | 2.5±0.25        | PERIMETER (MM) | 213.82 | STANDARD   | BS EN755    | SCALE   | 1.5:1   |  |
| MASS (KG/M)        | 1.388                   | UNSPECIFIED CORNERS   | R 0.3           | SURFACE AREA   | 108.21 | ALLOY      | 6063-T6     | VERSION | A       |  |
| COMPANY ISSUE      |                         | A                     | DRAWN           | 蔡晓婷            | DATE   | 2020-07-14 | APELLATION  | -       | PAGE OF |  |
|                    |                         |                       | STANDARDIZATION |                | DATE   |            |             |         |         |  |
|                    |                         |                       | TO SIGN         | 王添明            | DATE   |            |             |         |         |  |
|                    |                         |                       | AUDITING        |                | DATE   |            |             |         |         |  |
| MARKER             | MODIFY                  | FILE NO               | SIGNATURE       | DATE           | APPROV | DATE       |             |         |         |  |



|          |              |                   |           |               |           |
|----------|--------------|-------------------|-----------|---------------|-----------|
| CUSTOMER | HONGKONG CO. | CUSTOMER APPROVAL | / 16/7/20 | CUST PART NO. | X85827    |
|          |              |                   |           | SECTION NO.   | LH0091436 |

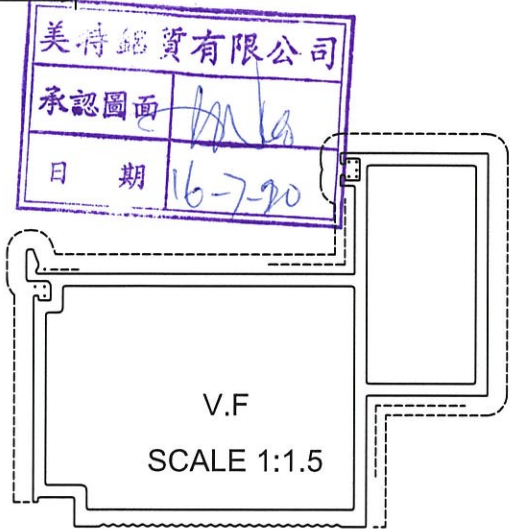
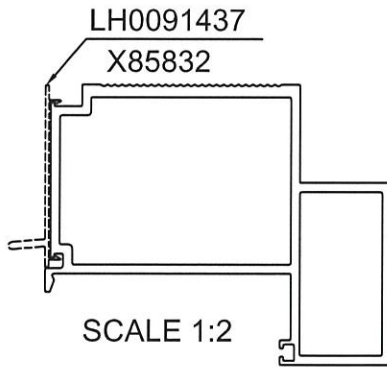
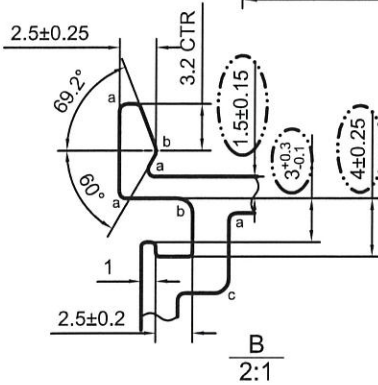
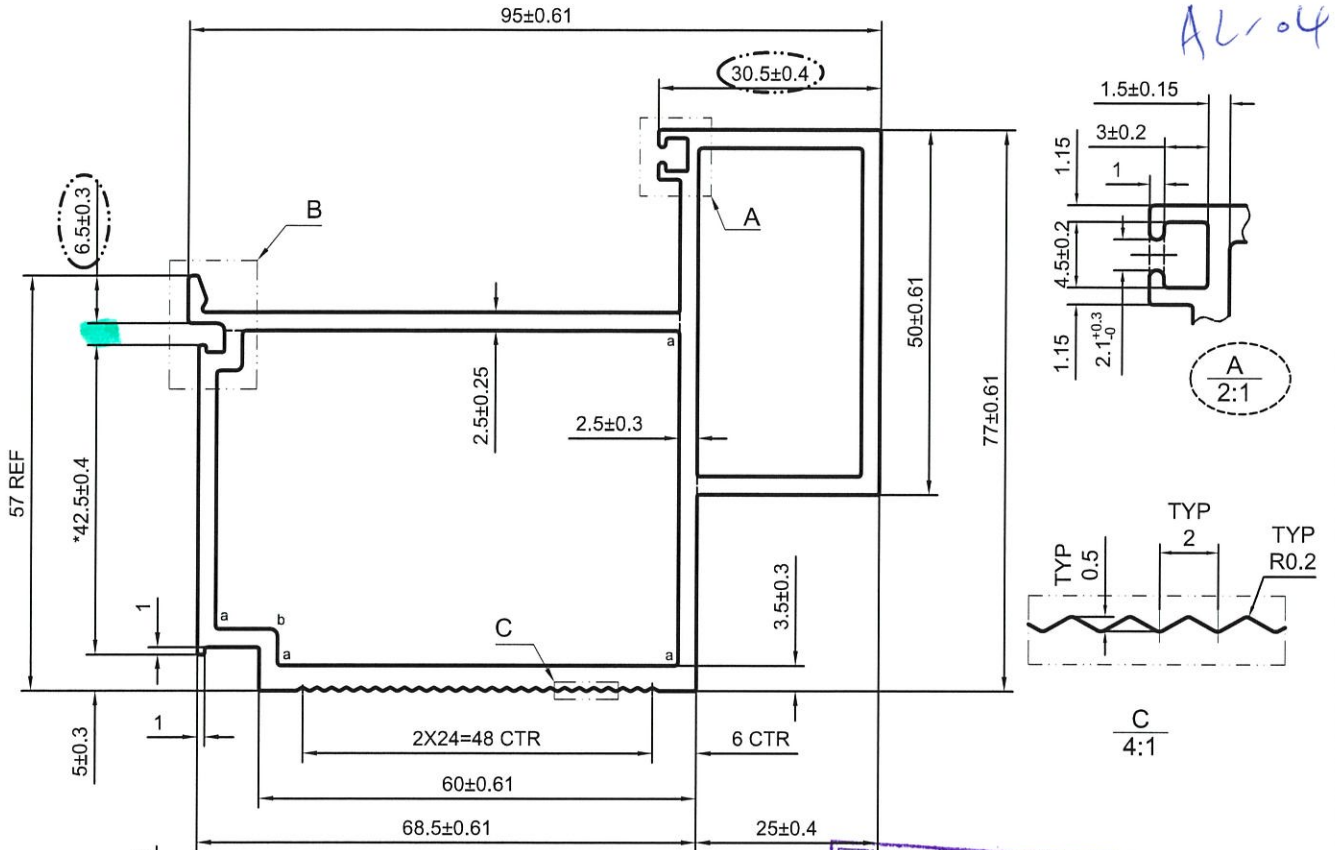

a=R0.5 b=R0.8 c=R1

----- 次要装饰面, 喷涂膜厚不足, 但不露底

----- 装饰面

●●●●● 凹槽位置可能会有露底现象, 即膜厚不足

\*配合尺寸以实物配合效果为准!

|                    |                         |                       |                 |                |                    |            |            |         |         |
|--------------------|-------------------------|-----------------------|-----------------|----------------|--------------------|------------|------------|---------|---------|
| SIGNATURE GRADEING | HIGH SIGNATURE GRADEING | C.C.DIA(MM)           | Ø 119.72        |                | 喷涂收费周长(mm): 304.46 |            |            |         |         |
| AREA (SQ MM)       | 944.48                  | UNSPECIFIED THICKNESS | 2.5±0.25        | PERIMETER (MM) | 385.12             | STANDARD   | BS EN755   | SCALE   | 1:1     |
| MASS (KG/M)        | 2.560                   | UNSPECIFIED CORNERS   | R 0.3           | SURFACE AREA   | 304.46             | ALLOY      | 6063-T6    | VERSION | B       |
| COMPANY ISSUE      |                         | A                     | DRAWN           | 蔡晓婷            | DATE               | 2020-07-14 | APELLATION | -       | PAGE OF |
|                    |                         |                       | STANDARDIZATION |                | DATE               |            |            |         |         |
|                    |                         |                       | TO SIGN         | 王添明            | DATE               |            |            |         |         |
|                    |                         |                       | AUDITING        |                | DATE               |            |            |         |         |
| MARKER             | MODIFY                  | FILE NO               | SIGNATURE       | DATE           | APPROV             | DATE       |            |         |         |

PANASIA ALUMINUM (CHINA) LIMITED

|          |              |                   |               |           |
|----------|--------------|-------------------|---------------|-----------|
| CUSTOMER | HONGKONG CO. | CUSTOMER APPROVAL | CUST PART NO. | X85828    |
|          |              |                   | SECTION NO.   | LH0091439 |

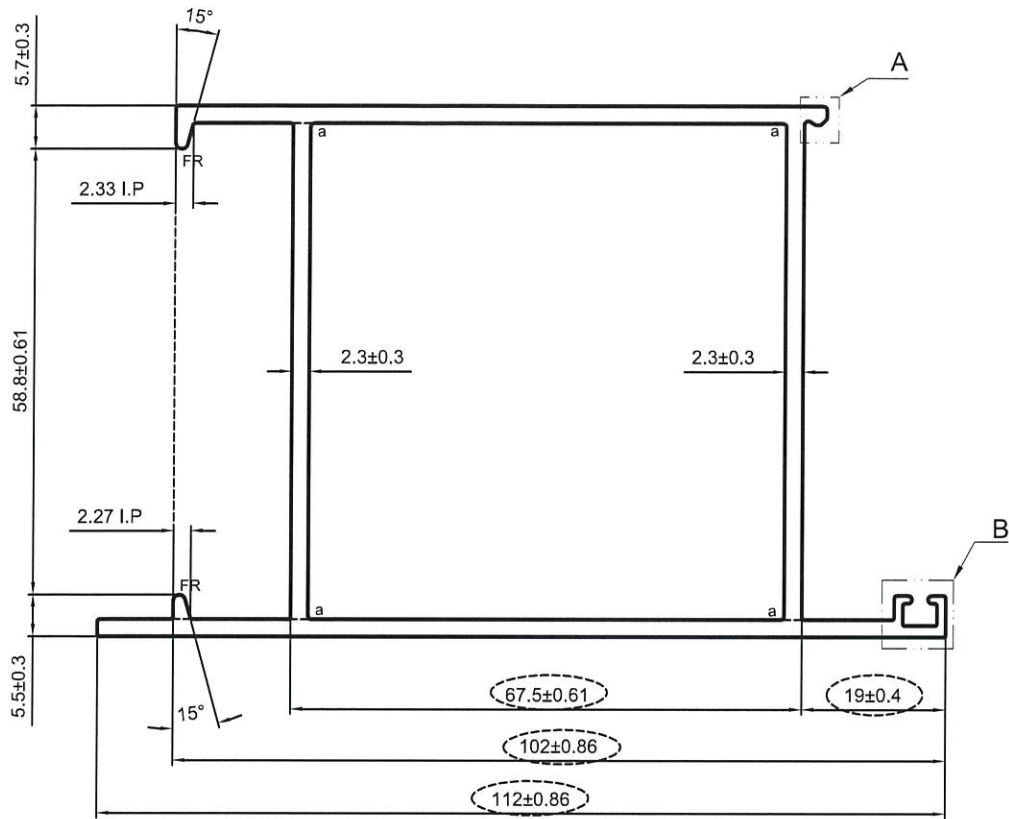

T 004

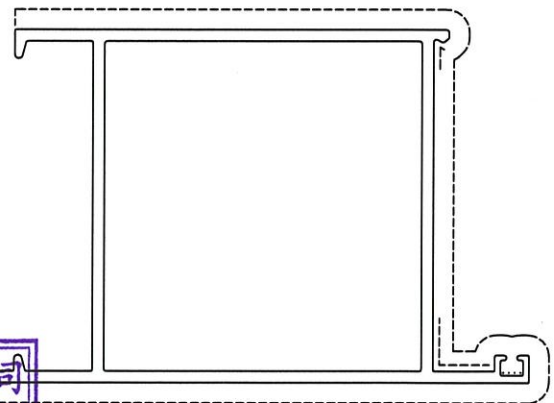
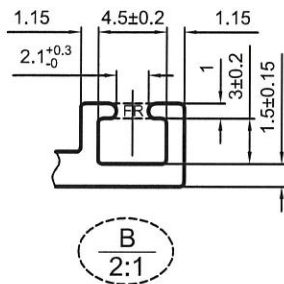
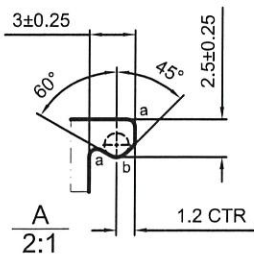

a=R0.5 b=R0.8

----- 次要装饰面, 喷涂膜厚不足, 但不露底

----- 装饰面

●●●●●● 凹槽位置可能会有露底现象, 即膜厚不足

\*配合尺寸以实物配合效果为准!

美特铝质有限公司  
承認圖面  
日期 16-7-20

V.F

SCALE 1:1.5

|                    |                         |                       |                 |                |                    |            |            |         |         |
|--------------------|-------------------------|-----------------------|-----------------|----------------|--------------------|------------|------------|---------|---------|
| SIGNATURE GRADEING | HIGH SIGNATURE GRADEING | C.C.DIA(MM)           | Ø 128.95        |                | 喷涂收费周长(mm): 307.22 |            |            |         |         |
| AREA (SQ MM)       | 773.91                  | UNSPECIFIED THICKNESS | 2.3±0.25        | PERIMETER (MM) | 427.59             | STANDARD   | BS EN755   | SCALE   | 1:1     |
| MASS (KG/M)        | 2.097                   | UNSPECIFIED CORNERS   | R 0.2           | SURFACE AREA   | 307.22             | ALLOY      | 6063-T6    | VERSION | B       |
| COMPANY ISSUE      |                         | A                     | DRAWN           | 蔡晓婷            | DATE               | 2020-07-14 | APELLATION | -       | PAGE OF |
|                    |                         |                       | STANDARDIZATION |                | DATE               |            |            |         |         |
|                    |                         |                       | TO SIGN         | 王添明            | DATE               |            |            |         |         |
|                    |                         |                       | AUDITING        |                | DATE               |            |            |         |         |
| MARKER             | MODIFY                  | FILE NO               | SIGNATURE       | DATE           | APPROV             | DATE       |            |         |         |

 PANASIA ALUMINUM (CHINA) LIMITED

|          |              |                   |               |           |
|----------|--------------|-------------------|---------------|-----------|
| CUSTOMER | HONGKONG CO. | CUSTOMER APPROVAL | CUST PART NO. | X85829    |
|          |              |                   | SECTION NO.   | LH0091440 |

AL-11

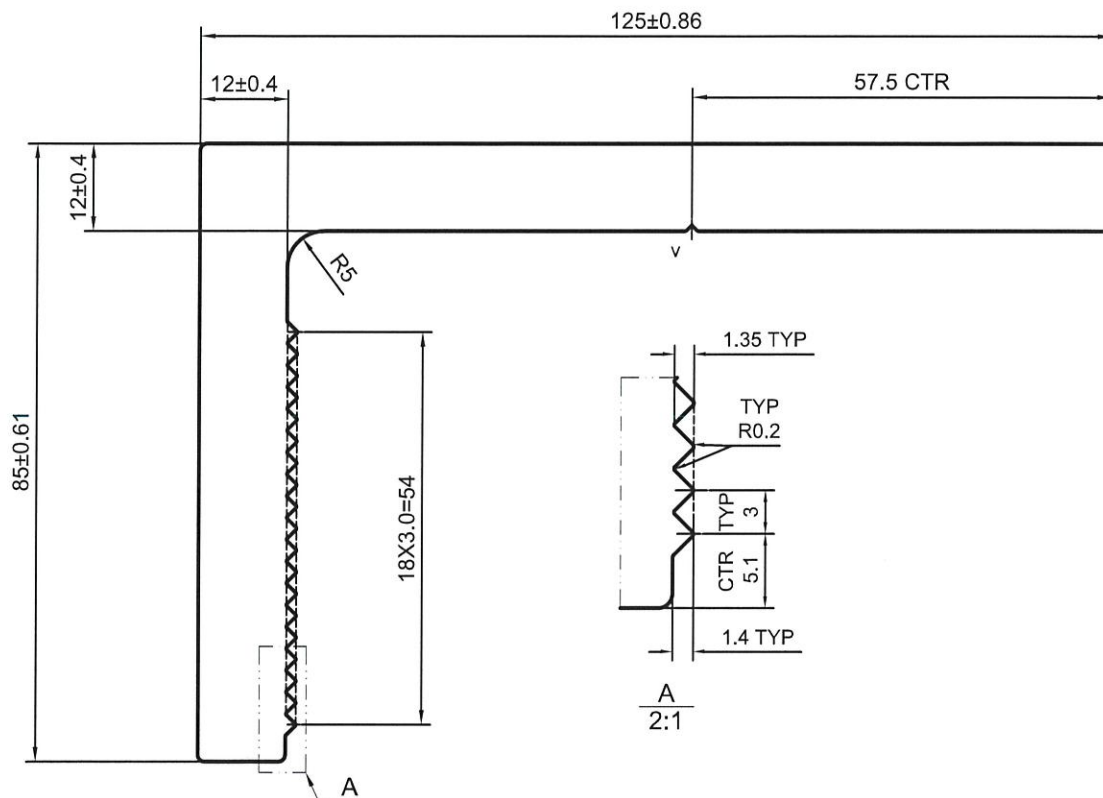

美特鋁質有限公司  
承認圖面  
日期 16-7-20

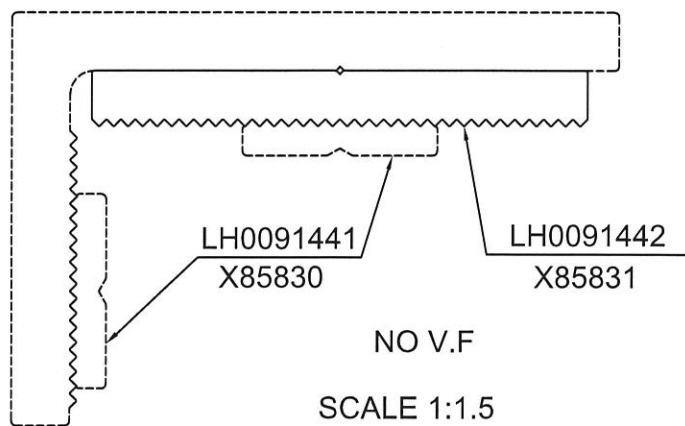

v=0.85X90°XR0.5

\*配合尺寸以实物配合效果为准!

|                    |                         |                       |                 |                |               |            |             |         |         |
|--------------------|-------------------------|-----------------------|-----------------|----------------|---------------|------------|-------------|---------|---------|
| SIGNATURE GRADEING | HIGH SIGNATURE GRADEING | C.C.DIA(MM)           | Ø 150.39        |                | 喷涂收费周长(mm): - |            |             |         |         |
| AREA (SQ MM)       | 2422.30                 | UNSPECIFIED THICKNESS | -               | PERIMETER (MM) | 436.79        | STANDARD   | BS EN755    | SCALE   | 1:1     |
| MASS (KG/M)        | 6.564                   | UNSPECIFIED CORNERS   | R 1             | SURFACE AREA   | -             | ALLOY      | 6061-T6     | VERSION | A       |
| COMPANY ISSUE      |                         | A                     | DRAWN           | 蔡晓婷            | DATE          | 2020-06-10 | APPELLATION | -       | PAGE OF |
|                    |                         |                       | STANDARDIZATION |                | DATE          |            |             |         |         |
|                    |                         |                       | TO SIGN         | 王添明            | DATE          |            |             |         |         |
|                    |                         |                       | AUDITING        |                | DATE          |            |             |         |         |
| MARKER             | MODIFY                  | FILE NO               | SIGNATURE       | DATE           | APPROV        | DATE       |             |         |         |

 PANASIA ALUMINUM (CHINA) LIMITED

|          |              |                   |               |           |
|----------|--------------|-------------------|---------------|-----------|
| CUSTOMER | HONGKONG CO. | CUSTOMER APPROVAL | CUST PART NO. | X85830    |
|          |              |                   | SECTION NO.   | LH0091441 |

AL-12

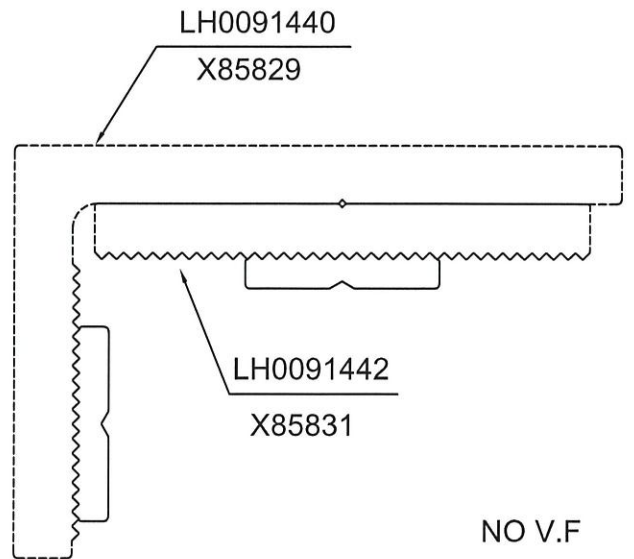
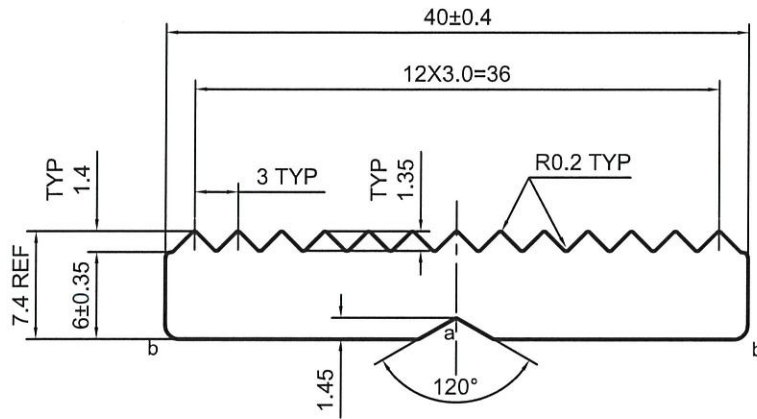

a=R0.2 b=R1

\*配合尺寸以实物配合效果为准!

NO V.F

SCALE 1:1

|                    |                         |                       |                 |                |        |            |            |         |         |
|--------------------|-------------------------|-----------------------|-----------------|----------------|--------|------------|------------|---------|---------|
| SIGNATURE GRADEING | HIGH SIGNATURE GRADEING | C.C.DIA(MM)           | Ø 40.28         | 喷涂收费周长(mm): -  |        |            |            |         |         |
| AREA (SQ MM)       | 264.85                  | UNSPECIFIED THICKNESS | -               | PERIMETER (MM) | 105.56 | STANDARD   | BS EN755   | SCALE   | 2:1     |
| MASS (KG/M)        | 0.718                   | UNSPECIFIED CORNERS   | R 0.4           | SURFACE AREA   | -      | ALLOY      | 6061-T6    | VERSION | A       |
| COMPANY ISSUE      |                         | A                     | DRAWN           | 蔡晓婷            | DATE   | 2020-06-11 | APELLATION | -       | PAGE OF |
|                    |                         |                       | STANDARDIZATION |                | DATE   |            |            |         |         |
|                    |                         |                       | TO SIGN         | 王添明            | DATE   |            |            |         |         |
|                    |                         |                       | AUDITING        |                | DATE   |            |            |         |         |
| MARKER             | MODIFY                  | FILE NO               | SIGNATURE       | DATE           | APPROV | DATE       |            |         |         |



|          |              |                   |               |           |
|----------|--------------|-------------------|---------------|-----------|
| CUSTOMER | HONGKONG CO. | CUSTOMER APPROVAL | CUST PART NO. | X85831    |
|          |              |                   | SECTION NO.   | LH0091442 |

A1-13

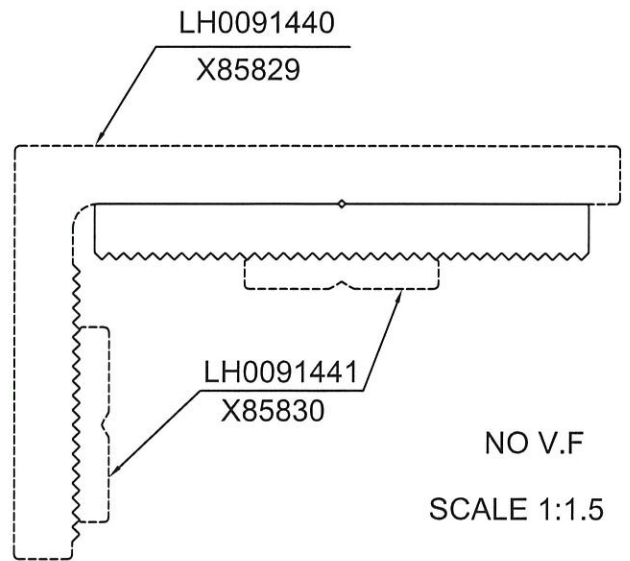
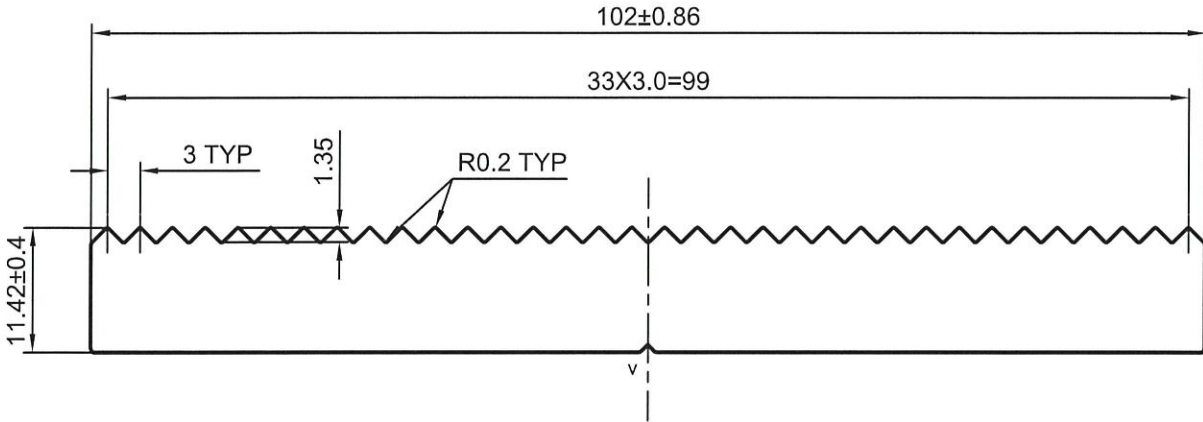

v=0.7X90°XR0.5

\*配合尺寸以实物配合效果为准!

|                    |                         |                       |                 |                |               |            |             |         |         |
|--------------------|-------------------------|-----------------------|-----------------|----------------|---------------|------------|-------------|---------|---------|
| SIGNATURE GRADEING | HIGH SIGNATURE GRADEING | C.C.DIA(MM)           | Ø 102.45        |                | 喷涂收费周长(mm): - |            |             |         |         |
| AREA (SQ MM)       | 1095.92                 | UNSPECIFIED THICKNESS | -               | PERIMETER (MM) | 105.56        | STANDARD   | BS EN755    | SCALE   | 1.5:1   |
| MASS (KG/M)        | 2.970                   | UNSPECIFIED CORNERS   | R 0.4           | SURFACE AREA   | -             | ALLOY      | 6061-T6     | VERSION | A       |
| COMPANY ISSUE      |                         | A                     | DRAWN           | 蔡晓婷            | DATE          | 2020-06-11 | APPELLATION | -       | PAGE OF |
|                    |                         |                       | STANDARDIZATION |                | DATE          |            |             |         |         |
|                    |                         |                       | TO SIGN         | 王添明            | DATE          |            |             |         |         |
|                    |                         |                       | AUDITING        |                | DATE          |            |             |         |         |
| MARKER             | MODIFY                  | FILE NO               | SIGNATURE       | DATE           | APPROV        |            |             |         |         |



PANASIA ALUMINUM (CHINA) LIMITED

|          |              |                   |     |               |           |
|----------|--------------|-------------------|-----|---------------|-----------|
| CUSTOMER | HONGKONG CO. | CUSTOMER APPROVAL | 修改了 | CUST PART NO. | X85832    |
|          |              |                   |     | SECTION NO.   | LH0091437 |

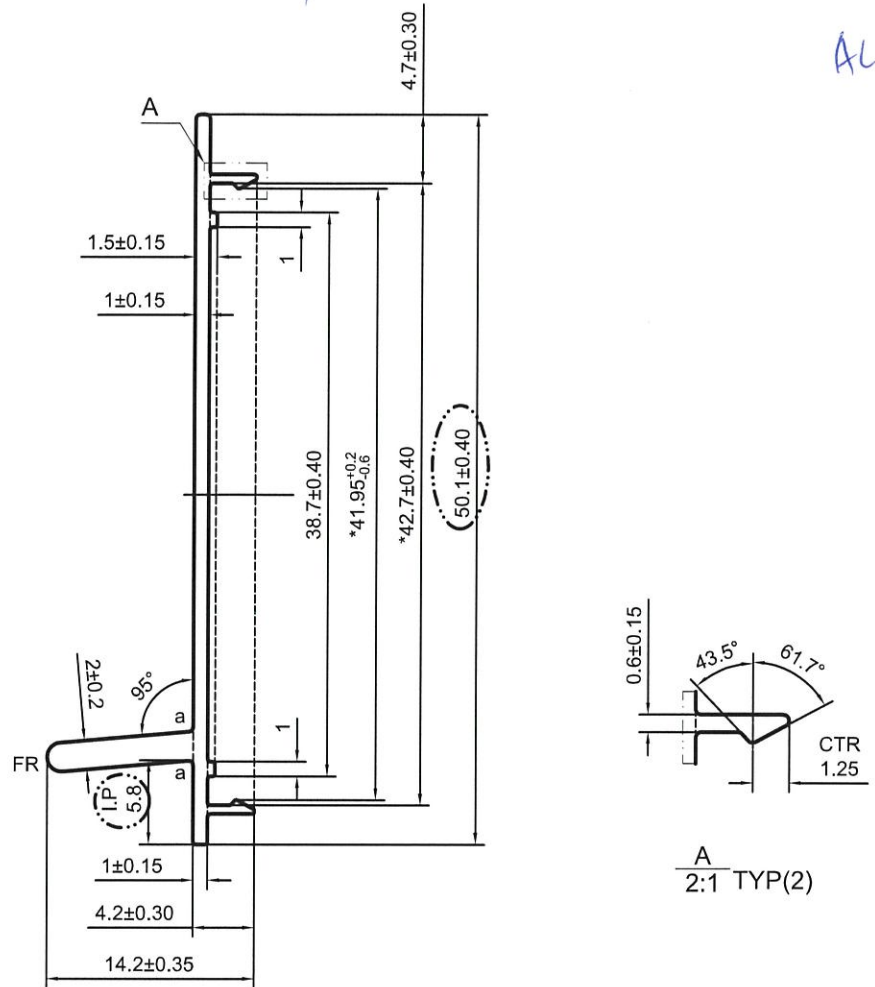

AL-38

美特鋁質有限公司  
承認圖面  
日期 16-7-20

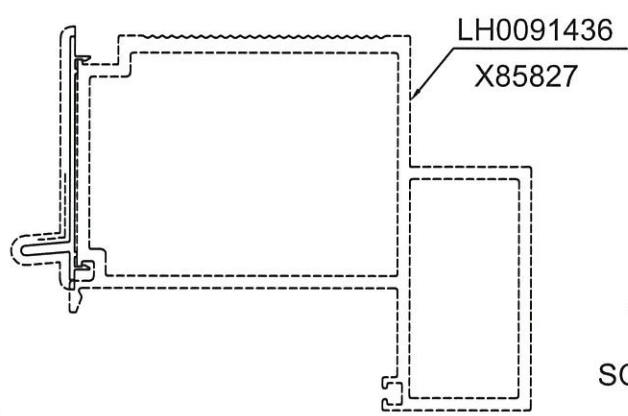

a=R0.3  
----- 次要裝飾面，噴塗膜厚不足，但不露底  
----- 裝飾面

\*配合尺寸以实物配合效果为准！

|                    |                         |                       |                 |                   |        |            |            |         |         |
|--------------------|-------------------------|-----------------------|-----------------|-------------------|--------|------------|------------|---------|---------|
| SIGNATURE GRADEING | HIGH SIGNATURE GRADEING | C.C.DIA(MM)           | Ø 49.11         | 噴塗收費周長(mm): 80.61 |        |            |            |         |         |
| AREA (SQ MM)       | 74.91                   | UNSPECIFIED THICKNESS | -               | PERIMETER (MM)    | 134.35 | STANDARD   | BS EN755   | SCALE   | 2:1     |
| MASS (KG/M)        | 0.203                   | UNSPECIFIED CORNERS   | R 0.2           | SURFACE AREA      | 71.12  | ALLOY      | 6063-T6    | VERSION | A       |
| COMPANY ISSUE      |                         | A                     | DRAWN           | 蔡曉婷               | DATE   | 2020-06-10 | APELLATION | -       | PAGE OF |
|                    |                         |                       | STANDARDIZATION |                   | DATE   |            |            |         |         |
|                    |                         |                       | TO SIGN         | 王添明               | DATE   |            |            |         |         |
|                    |                         |                       | AUDITING        |                   | DATE   |            |            |         |         |
| MARKER             | MODIFY                  | FILE NO               | SIGNATURE       | DATE              | APPROV | DATE       |            |         |         |

PANASIA ALUMINUM (CHINA) LIMITED

|          |              |                   |     |               |           |
|----------|--------------|-------------------|-----|---------------|-----------|
| CUSTOMER | HONGKONG CO. | CUSTOMER APPROVAL | 修改了 | CUST PART NO. | X85833    |
|          |              |                   |     | SECTION NO.   | LH0091434 |

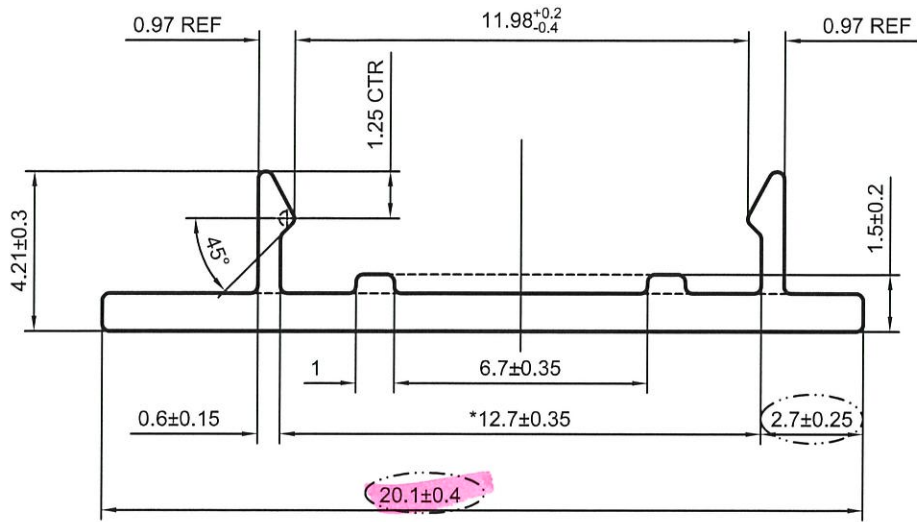

AL-39

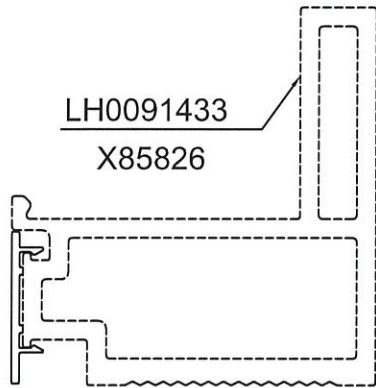

|          |                    |
|----------|--------------------|
| 美特鋁質有限公司 |                    |
| 承認圖面     | <i>[Signature]</i> |
| 日期       | 16-7-20            |

SCALE 1:1



V.F  
SCALE 3:1

\*配合尺寸以实物配合效果为准!

|                    |                         |                       |                 |                |             |            |             |         |         |
|--------------------|-------------------------|-----------------------|-----------------|----------------|-------------|------------|-------------|---------|---------|
| SIGNATURE GRADEING | HIGH SIGNATURE GRADEING | C.C.DIA(MM)           | Ø 20.11         |                | 喷涂收费周长(mm): |            | 33.29       |         |         |
| AREA (SQ MM)       | 25.26                   | UNSPECIFIED THICKNESS | 1±0.15          | PERIMETER (MM) | 55.48       | STANDARD   | BS EN755    | SCALE   | 5:1     |
| MASS (KG/M)        | 0.068                   | UNSPECIFIED CORNERS   | R 0.2           | SURFACE AREA   | 22.16       | ALLOY      | 6063-T6     | VERSION | A       |
| COMPANY ISSUE      |                         | A                     | DRAWN           | 陈晓舒            | DATE        | 2020-06-09 | APPELLATION | -       | PAGE OF |
|                    |                         |                       | STANDARDIZATION |                | DATE        |            |             |         |         |
|                    |                         |                       | TO SIGN         | 王添明            | DATE        |            |             |         |         |
|                    |                         |                       | AUDITING        |                | DATE        |            |             |         |         |
| MARKER             | MODIFY                  | FILE NO               | SIGNATURE       | DATE           | APPROV      | DATE       |             |         |         |

PANASIA ALUMINUM (CHINA) LIMITED

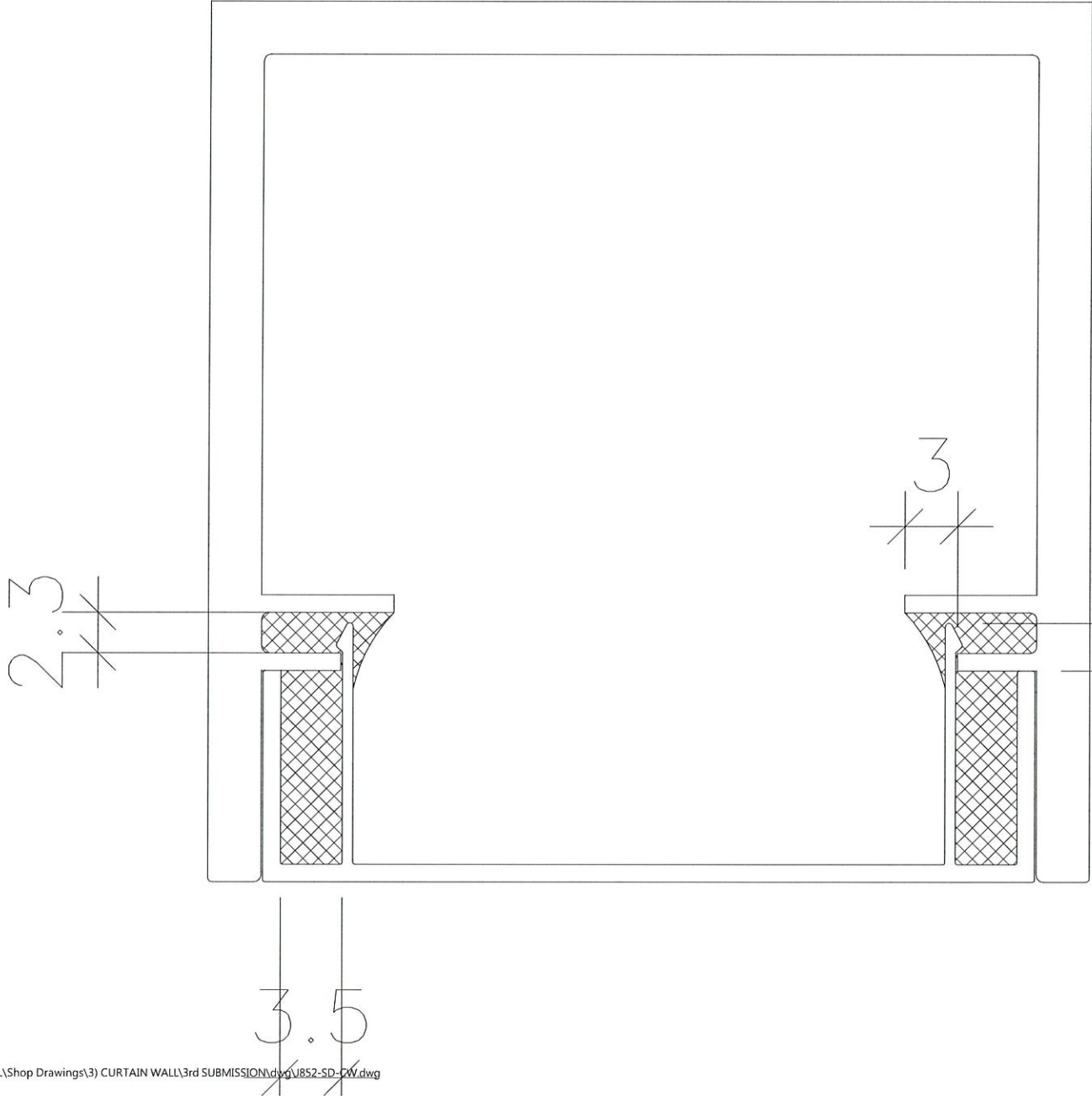

重新建議

1. 上面是否OK?  
3月後是否OK?