

Drawing Submission Form

To : Grand Tech Construction Co., Ltd Attn : Mr. Elvis Koo
 Address : 22/F, Railway Plaza, 39 Chatham Road South, Tsim Sha Tsui, Kowloon
 Project Code : SIC20-024 Date : 16 April 2021
 Project Name : 18 Sai Shan Road Our Ref : SIC20-024/DS/012
 Contract Name : Design, Supply & Installation of Vertical Green System for Residential Development At 18 Sai Shan Road, Tsing Yi, Kwai Tsing District (Tsing Yi Town Lot 190)

Subject: Submission of Drawing Submission for Vertical Green System

We submit herewith the following information for () information/ (✓) approval / (✓) others: Comment

Item	Location	Drawing No.	Rev
1	Green wall (VG02e-g)- Location Plan UG/F & 1/F	SIC20-024-VG02e-g-101	A
2	Green wall (VG02e-g)- Elevation	SIC20-024-VG02e-g-102	B
3	Green wall (VG02e-g)- Elevation	SIC20-024-VG02e-g-103	-
4	Green wall (VG02e-g)- Elevation	SIC20-024-VG02e-g-104	-
5	Green wall (VG02e-g)- Elevation	SIC20-024-VG02e-g-105	-
6	Green wall (VG02e-g)- Plan & Detail	SIC20-024-VG02e-g-106	B
7	Green wall (VG02e-g)- Section & Details	SIC20-024-VG02e-g-107	A
8	Green wall (VG02e-g)- Elevation	SIC20-024-VG02e-g-108	-
9	Green wall (VG02e-g)- Elevation	SIC20-024-VG02e-g-109	A
10	Green wall (VG02e-g)- Elevation	SIC20-024-VG02e-g-110	-
11	Green wall (VG02e-g)- Irrigation Elevation	SIC20-024-VG02e-g-111	-
12	Green wall (VG02e-g)- Irrigation Elevation	SIC20-024-VG02e-g-112	-
13	Green wall (VG02e-g)- Irrigation Elevation	SIC20-024-VG02e-g-113	-
14	Schematic Diagram Of Automatic Irrigation System (1)	SIC20-024-VG02e-g-114	-
15	Schematic Diagram Of Automatic Irrigation System (2)	SIC20-024-VG02e-g-115	-
16	Schematic Diagram Of Automatic Irrigation System (3)	SIC20-024-VG02e-g-116	-

Expected Reply Date: 30 April 2021

Comment:

Contractor Representative:



Name: Maggie Tsang

Position: Senior Operation Manager

MT/lt/kc



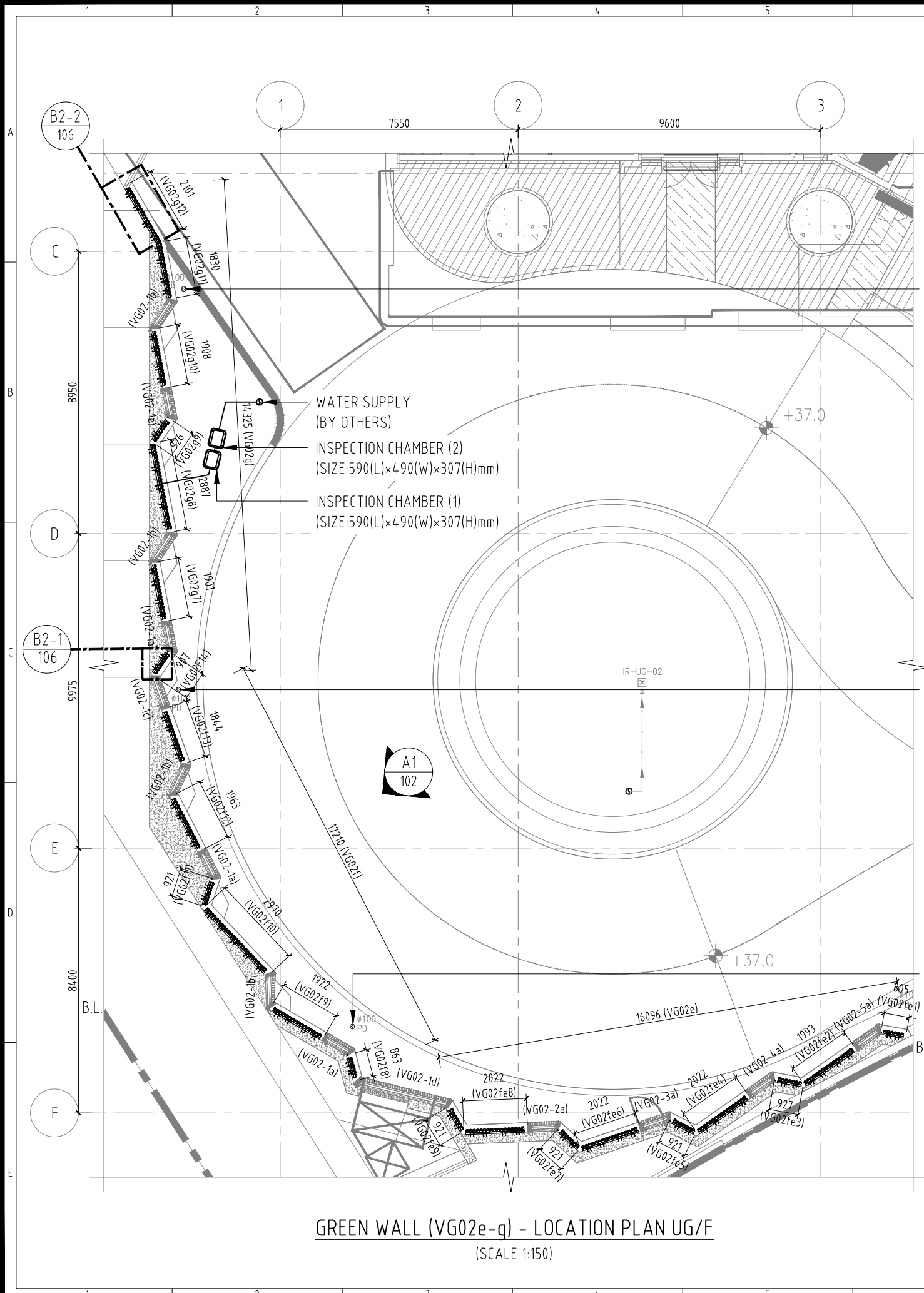

GREEN WALL (VG02e-g) - LOCATION PLAN UG/F
(SCALE 1:150)

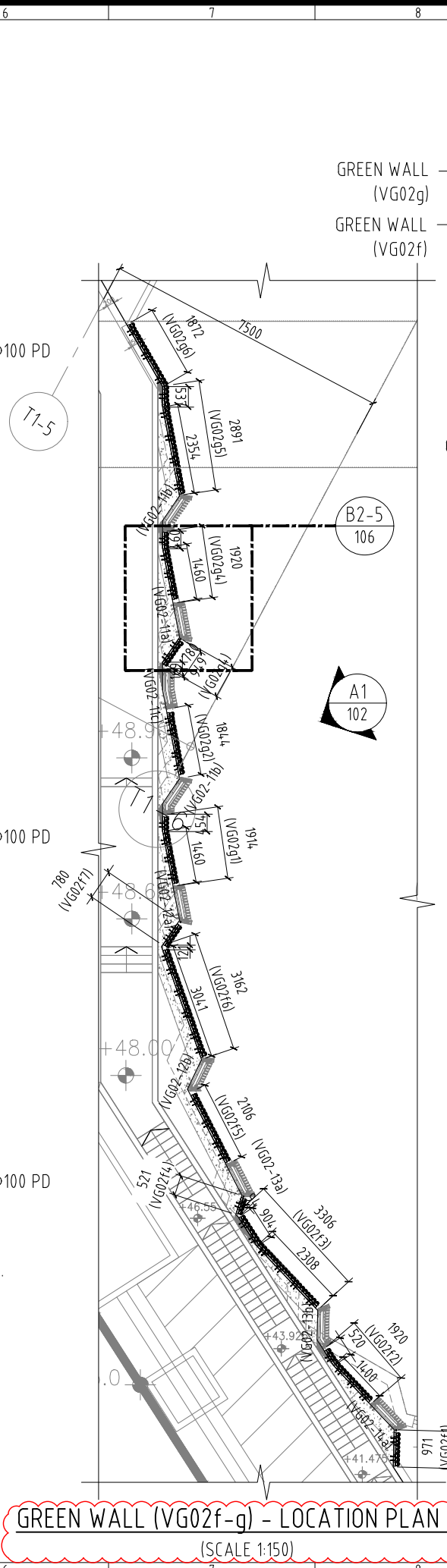

GREEN WALL (VG02f-g) - LOCATION PLAN 1/F
(SCALE 1:150)

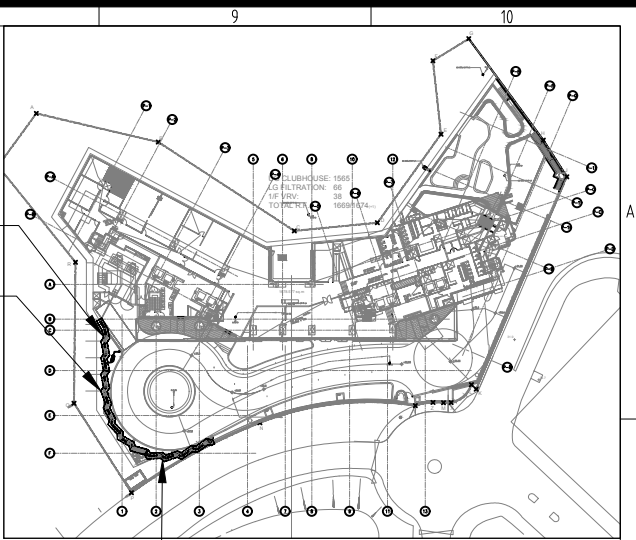

KEY PLAN

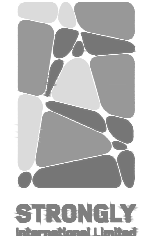
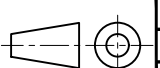
CAD FILE: SIC20-024-VG02e-g-101		
REV.	DESCRIPTION	DATE
-		15.09.20
A	DESIGN REVISED	21.01.21
B	DESIGN REVISED	09.04.21
CLIENT:		
ARCHITECT:		
LANDSCAPE ARCHITECT:		
STRUCTURAL ENGINEER:		
E & M CONTRACTOR:		
MAIN CONTRACTOR:		
SUB CONTRACTOR:		
 STRONGLY International Limited		
TEL: 3696 6688 FAX: 3696 6699 EMAIL: strongly@hkvgl.com		
Copyright Strongly International Limited. All rights reserved.		
DRAWN	CHECKED	APPROVED
HUA	YANG	LEE
DATE	09-04-2021	
PROJECT No.	SIC20-024	
PROJECT GREEN WALL SYSTEM AT TSING YI TOWN LOT 190 SAI SHAN ROAD		
TITLE GREEN WALL (VG02e-g) - LOCATION PLAN UG/F & 1/F		
SCALE	1: 150 OR AS STATED	
DRAWING NUMBER SIC20-024-VG02e-g-101		
DRF210335D	REV. A	
		
ALL DIMENSIONS IN mm A3 SIZE (420 x 297) DO NOT SCALE		

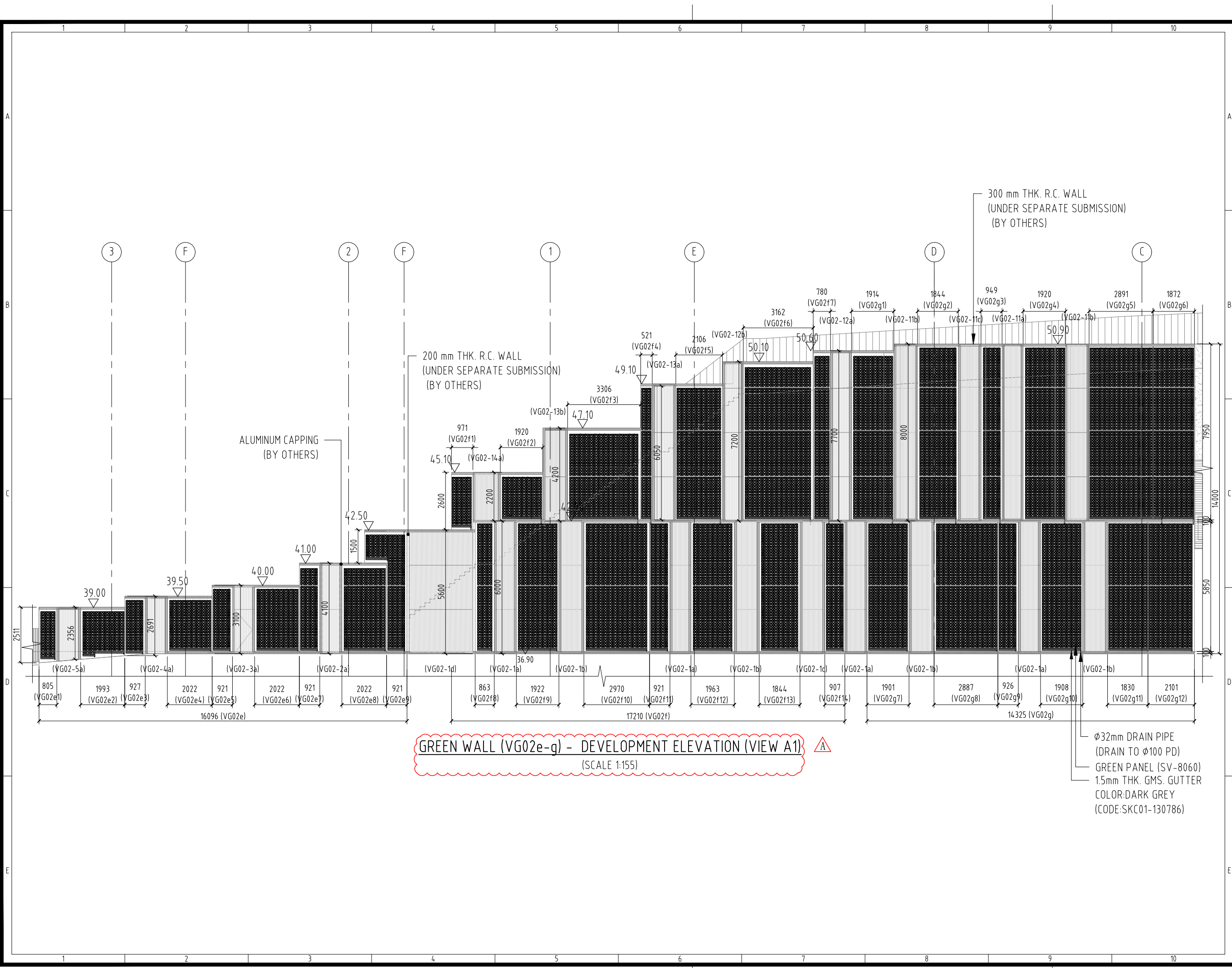

GREEN WALL (VG02e-g) - DEVELOPMENT ELEVATION (VIEW A1) A
 (SCALE 1:155)

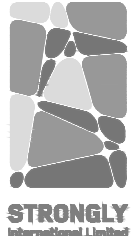
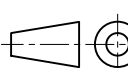
CAD FILE: SIC20-024-VG02e-g-101		
REV.	DESCRIPTION	DATE
-		15.09.20
A	DESIGN REVISED	21.01.21
B	DESIGN REVISED	09.04.21
CLIENT:		
ARCHITECT:		
LANDSCAPE ARCHITECT:		
STRUCTURAL ENGINEER:		
E & M CONTRACTOR:		
MAIN CONTRACTOR:		
SUB CONTRACTOR:		
 STRONGLY <small>International Limited</small>		
TEL: 3696 6688 FAX: 3696 6699 EMAIL: strongly@hkvgl.com		
Copyright Strongly International Limited. All rights reserved.		
DRAWN	CHECKED	APPROVED
HUA	YANG	LEE
DATE	09-04-2021	
PROJECT No.	SIC20-024	
PROJECT GREEN WALL SYSTEM AT TSING YI TOWN LOT 190 SAI SHAN ROAD		
TITLE GREEN WALL (VG02e-g) - ELEVATION		
SCALE	1: 155 OR AS STATED	
DRAWING NUMBER SIC20-024-VG02e-g-102		
DRF210335D	REV. B	
		
ALL DIMENSIONS IN mm A3 SIZE (420 x 297) DO NOT SCALE		

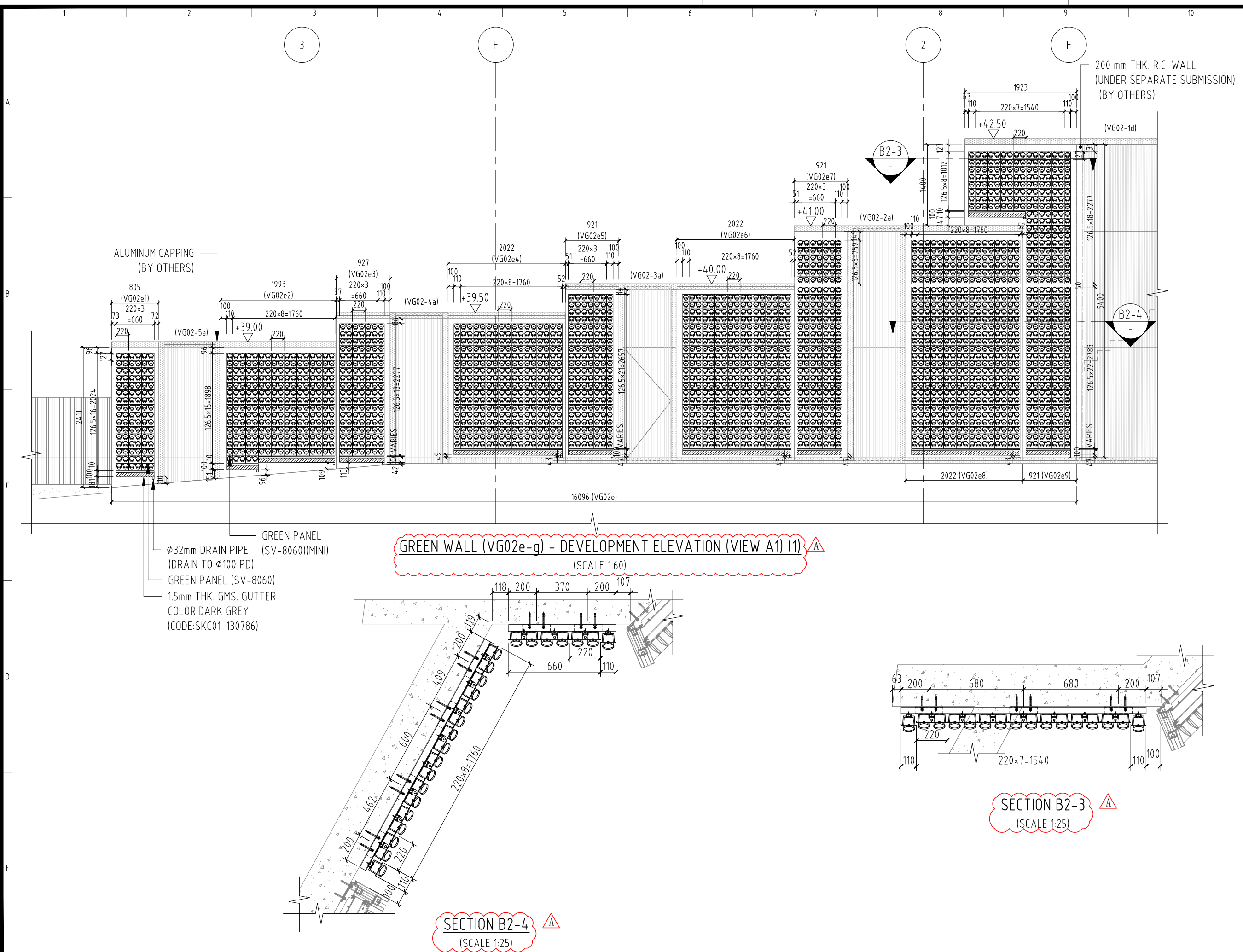

GREEN WALL (VG02e-g) - DEVELOPMENT ELEVATION (VIEW A1) (1)
 (SCALE 1:60)

- ALUMINUM CAPPING (BY OTHERS)
- GREEN PANEL (SV-8060)(MINI)
- φ32mm DRAIN PIPE (DRAIN TO φ100 PD)
- GREEN PANEL (SV-8060)
- 1.5mm THK. GMS. GUTTER
- COLOR:DARK GREY
- (CODE:SKC01-130786)

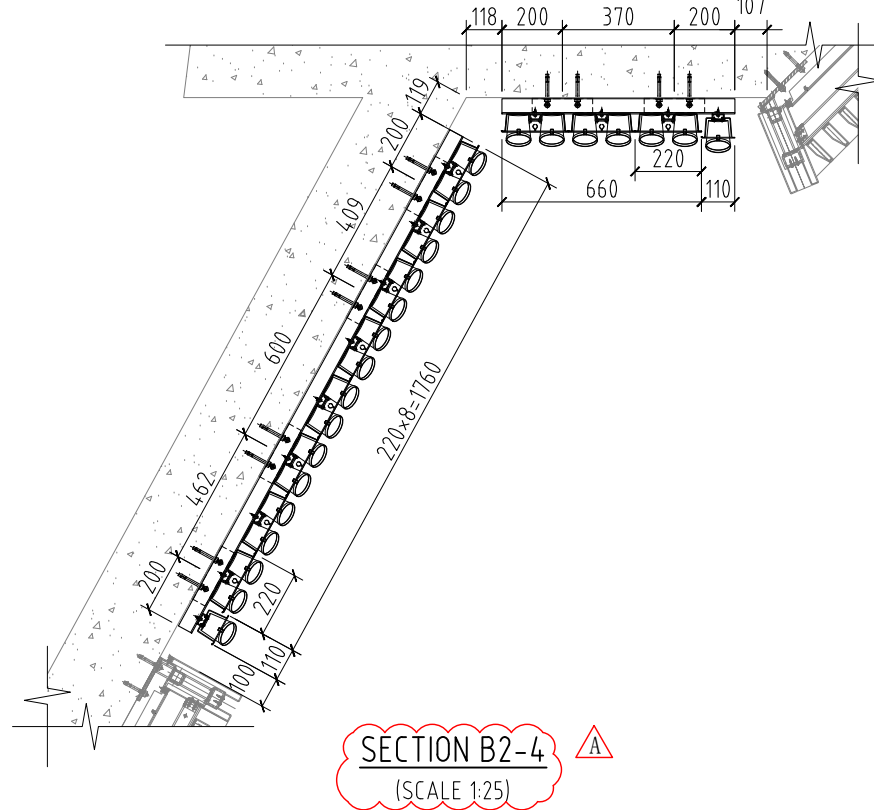

SECTION B2-4
 (SCALE 1:25)

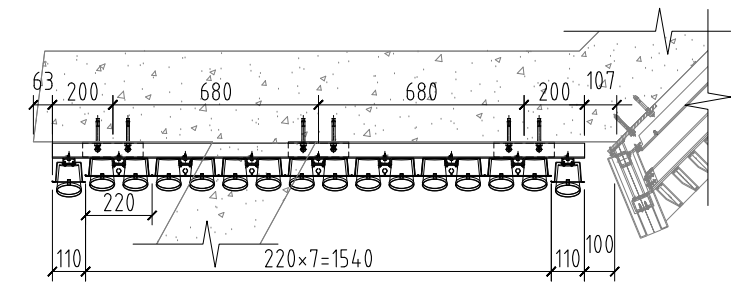

SECTION B2-3
 (SCALE 1:25)

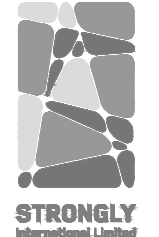
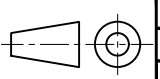
CAD FILE: SIC20-024-VG02e-g-101		
REV.	DESCRIPTION	DATE
-		09.04.21
CLIENT:		
ARCHITECT:		
LANDSCAPE ARCHITECT:		
STRUCTURAL ENGINEER:		
E & M CONTRACTOR:		
MAIN CONTRACTOR:		
SUB CONTRACTOR:		
 STRONGLY <small>International Limited</small>		
TEL: 3696 6688 FAX: 3696 6699 EMAIL: strongly@hkvgl.com		
Copyright Strongly International Limited. All rights reserved.		
DRAWN	CHECKED	APPROVED
HUA	YANG	LEE
DATE	09-04-2021	
PROJECT No.	SIC20-024	
PROJECT GREEN WALL SYSTEM AT TSING YI TOWN LOT 190 SAI SHAN ROAD		
TITLE GREEN WALL (VG02e-g) - ELEVATION		
SCALE	1: 155 OR AS STATED	
DRAWING NUMBER SIC20-024-VG02e-g-103		
DRF210335D	REV. -	
		
ALL DIMENSIONS IN mm A3 SIZE (420 x 297) DO NOT SCALE		

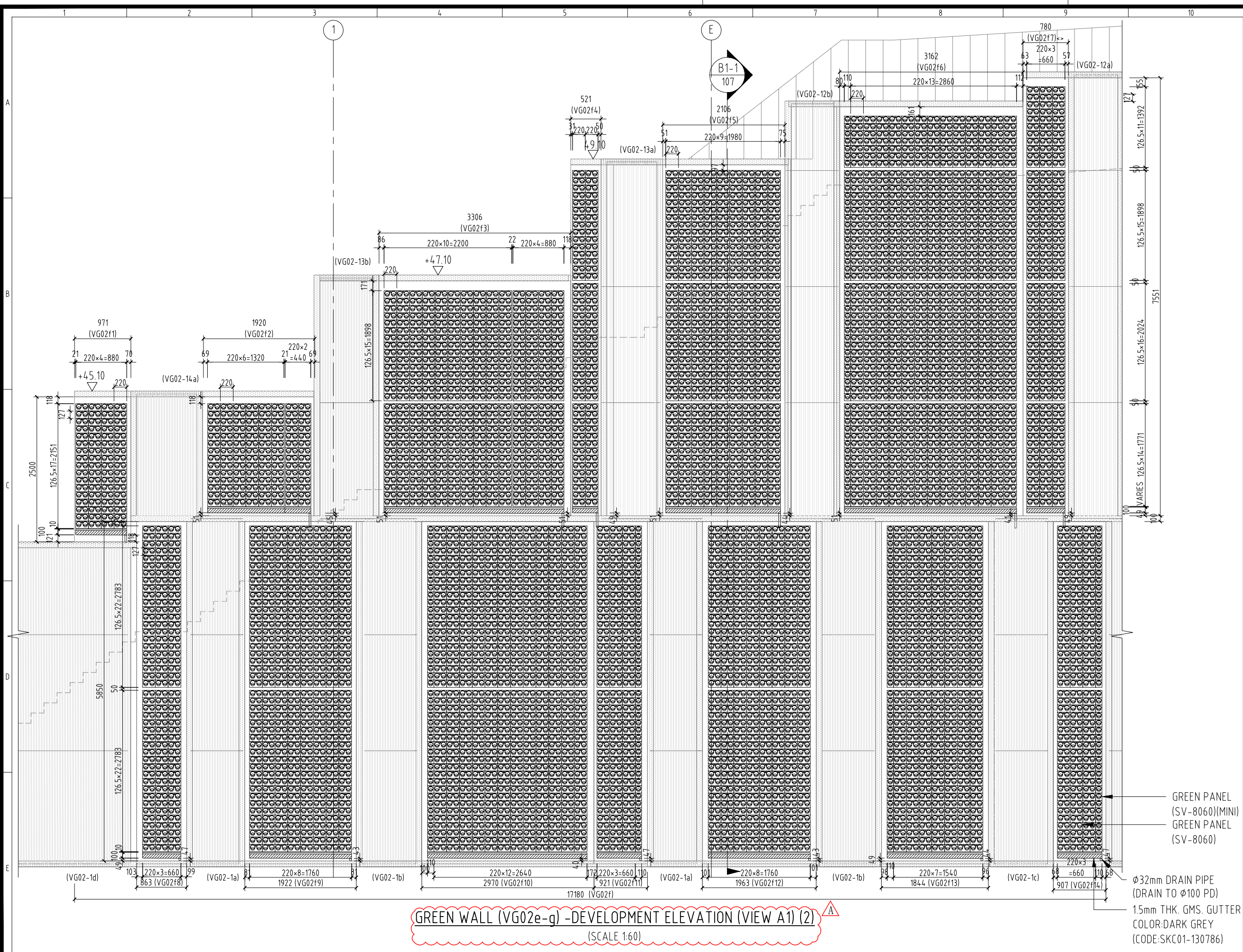

GREEN WALL (VG02e-g) -DEVELOPMENT ELEVATION (VIEW A1) (2)
 (SCALE 1:60)

GREEN PANEL (SV-8060)(MINI)
 GREEN PANEL (SV-8060)
 φ32mm DRAIN PIPE (DRAIN TO φ100 PD)
 1.5mm THK. GMS. GUTTER
 COLOR:DARK GREY (CODE:SKC01-130786)

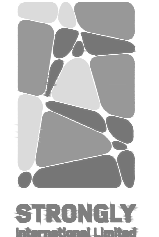
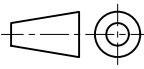
CAD FILE: SIC20-024-VG02e-g-101		
REV.	DESCRIPTION	DATE
-		210121
CLIENT:		
ARCHITECT:		
LANDSCAPE ARCHITECT:		
STRUCTURAL ENGINEER:		
E & M CONTRACTOR:		
MAIN CONTRACTOR:		
SUB CONTRACTOR:		
 STRONGLY <small>International Limited</small>		
TEL: 3696 6688 FAX: 3696 6699 EMAIL: strongly@hkvgl.com		
Copyright Strongly International Limited. All rights reserved.		
DRAWN	CHECKED	APPROVED
HUA	YANG	LEE
DATE	09-04-2021	
PROJECT No.	SIC20-024	
PROJECT GREEN WALL SYSTEM AT TSING YI TOWN LOT 190 SAI SHAN ROAD		
TITLE GREEN WALL (VG02e-g) - ELEVATION		
SCALE	1: 155 OR AS STATED	
DRAWING NUMBER SIC20-024-VG02e-g-104		
DRF210335D	REV.	-
		
ALL DIMENSIONS IN mm A3 SIZE (420 x 297) DO NOT SCALE		

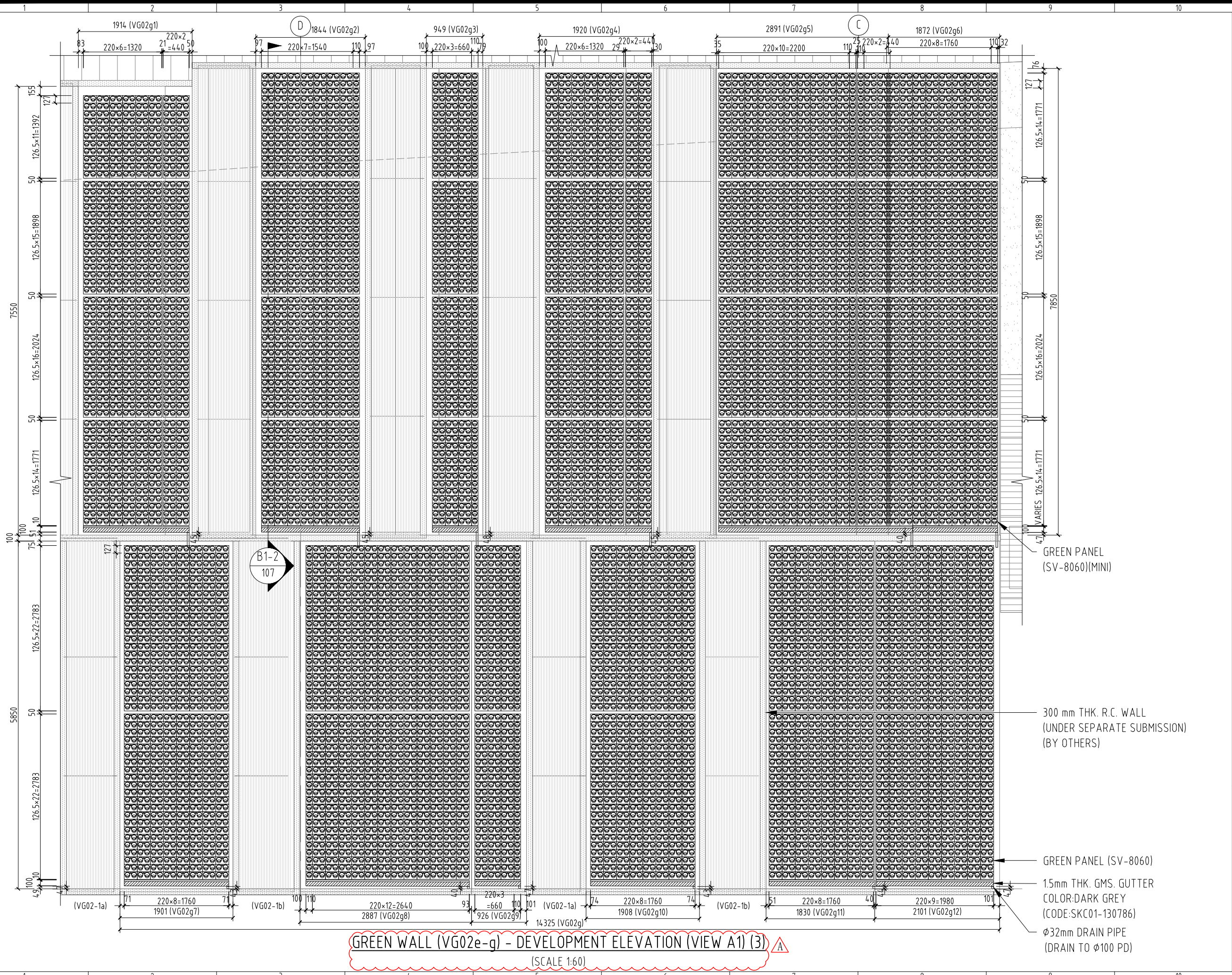

GREEN WALL (VG02e-g) - DEVELOPMENT ELEVATION (VIEW A1) (3)
 (SCALE 1:60)

CAD FILE:
 SIC20-024-VG02e-g-101

REV.	DESCRIPTION	DATE
-		09.04.21

CLIENT:

ARCHITECT:

LANDSCAPE ARCHITECT:

STRUCTURAL ENGINEER:

E & M CONTRACTOR:

MAIN CONTRACTOR:

SUB CONTRACTOR:

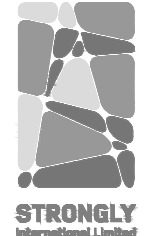

STRONGLY
 International Limited

TEL: 3696 6688 FAX: 3696 6699
 EMAIL: strongly@hkvgl.com

Copyright Strongly International Limited.
 All rights reserved.

DRAWN	CHECKED	APPROVED
HUA	YANG	LEE

DATE: 09-04-2021

PROJECT No. SIC20-024

PROJECT
 GREEN WALL SYSTEM AT TSING YI TOWN LOT 190 SAI SHAN ROAD

TITLE
 GREEN WALL (VG02e-g) - ELEVATION

SCALE: 1:155 OR AS STATED

DRAWING NUMBER
 SIC20-024-VG02e-g-105

DRF210335D REV. -

ALL DIMENSIONS IN mm
 A3 SIZE (420 x 297)
 DO NOT SCALE

MARKS	TYPE OF SECTION	GRADE
EA1	50x50x4mm THK. G.M.S. ANGLE (L=200mm)	S275J0
EA2	50x50x4mm THK G.M.S. ANGLE	
RH1	40x20x3mm THK. G.M.S. R.H.S. (CONTINUE)	
M5.5	M5.5 SCREW	A4-80
M8	M8 BOLT & NUT (L=25mm)	
HM10	HILTI HST3-R M10(L=90mm) ANCHOR BOLT	A4-70

CAD FILE: SIC20-024-VG02e-g-101		
REV.	DESCRIPTION	DATE
-		15.09.20
A	DESIGN REVISED	21.01.21
B	DESIGN REVISED	09.04.21

CLIENT:
ARCHITECT:
LANDSCAPE ARCHITECT:
STRUCTURAL ENGINEER:
E & M CONTRACTOR:
MAIN CONTRACTOR:
SUB CONTRACTOR:

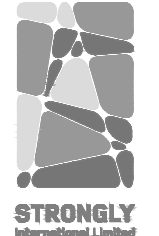

TEL: 3696 6688 FAX: 3696 6699
EMAIL: strongly@hkvgl.com

Copyright Strongly International Limited.
All rights reserved.

DRAWN	CHECKED	APPROVED
HUA	YANG	LEE

DATE: 09-04-2021

PROJECT No. SIC20-024

PROJECT
GREEN WALL SYSTEM AT TSING YI
TOWN LOT 190 SAI SHAN ROAD

TITLE
**GREEN WALL (VG02e-g)
- PLAN & DETAIL**

SCALE: 1:16 OR AS STATED

DRAWING NUMBER
SIC20-024-VG02e-g-106

DRF210335D REV. B

ALL DIMENSIONS IN mm
A3 SIZE (420 x 297)
DO NOT SCALE

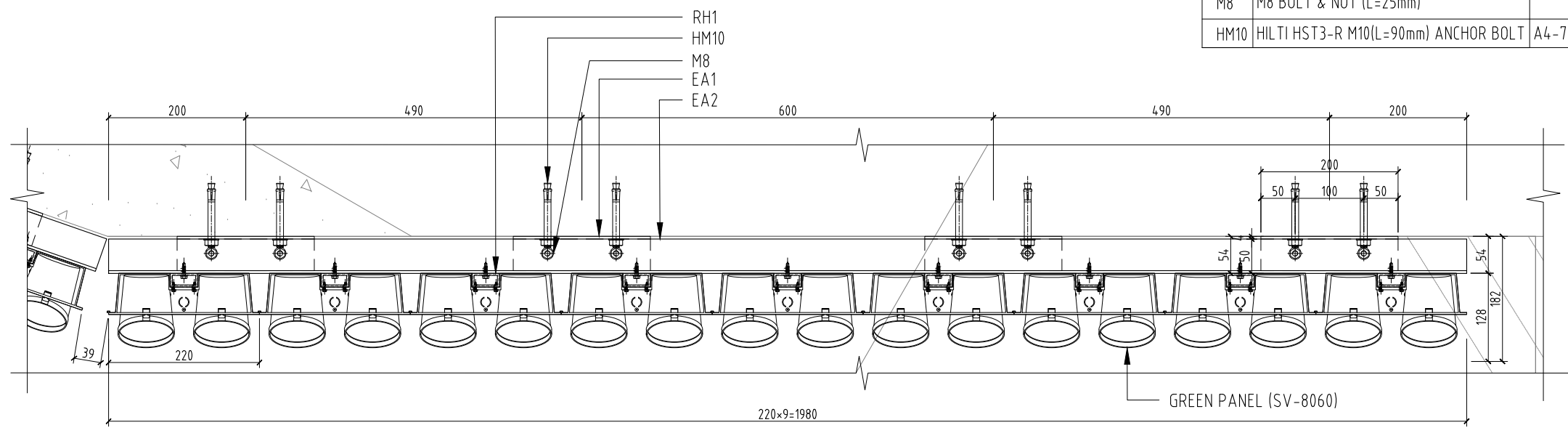

DETAIL B2-2
(SCALE 1:8)

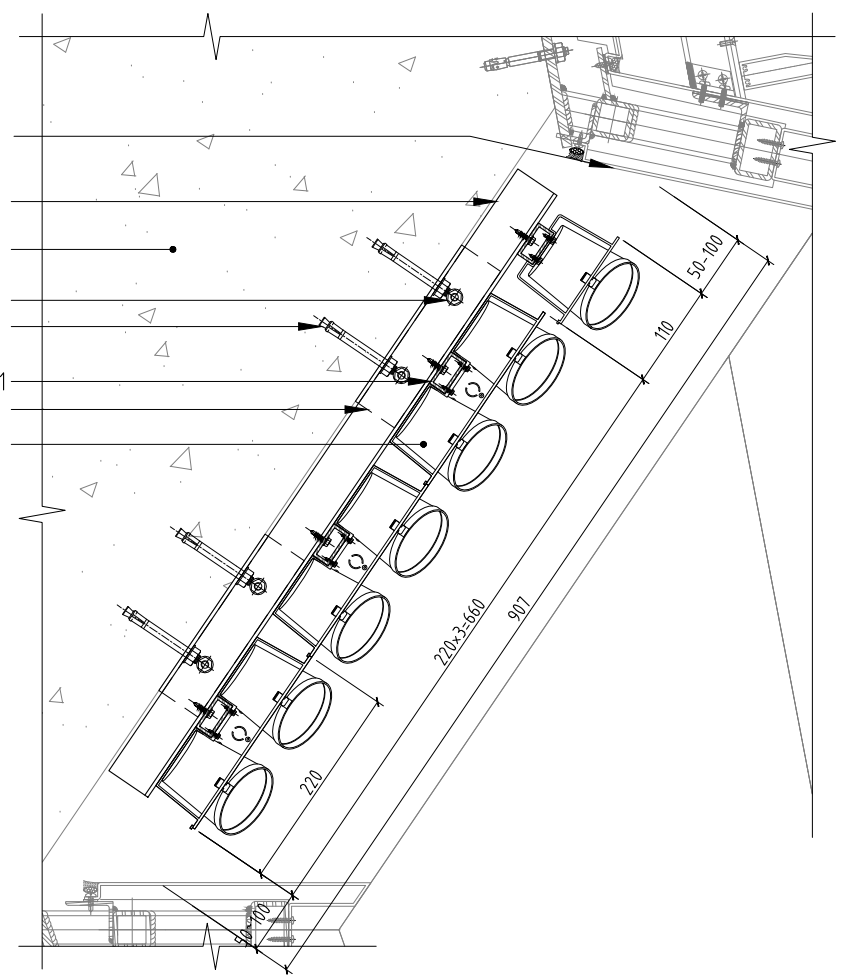

DETAIL B2-1
(SCALE 1:8)

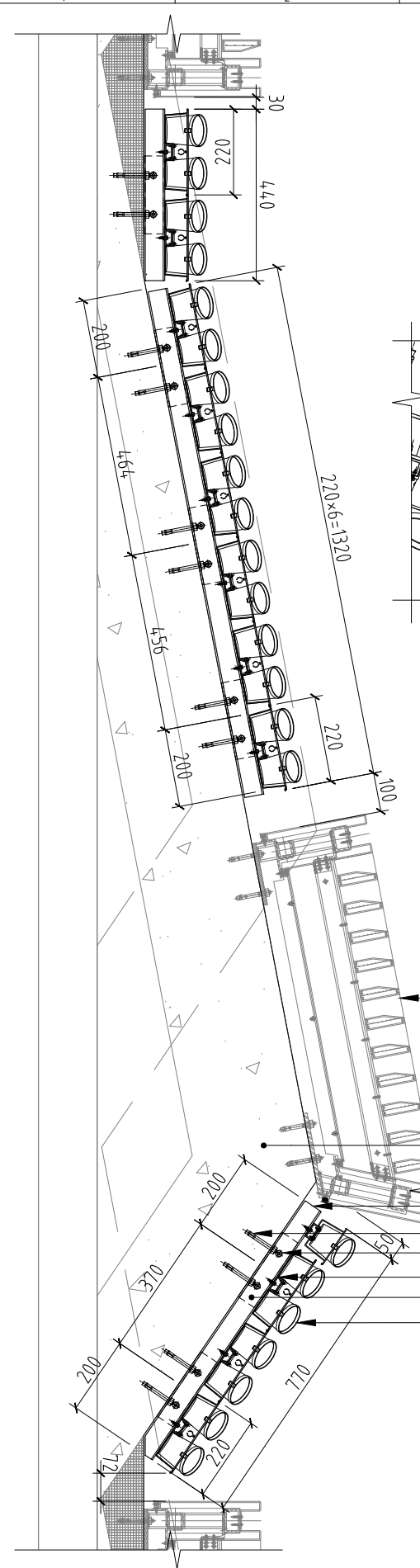

DETAIL B2-5
(SCALE 1:16)

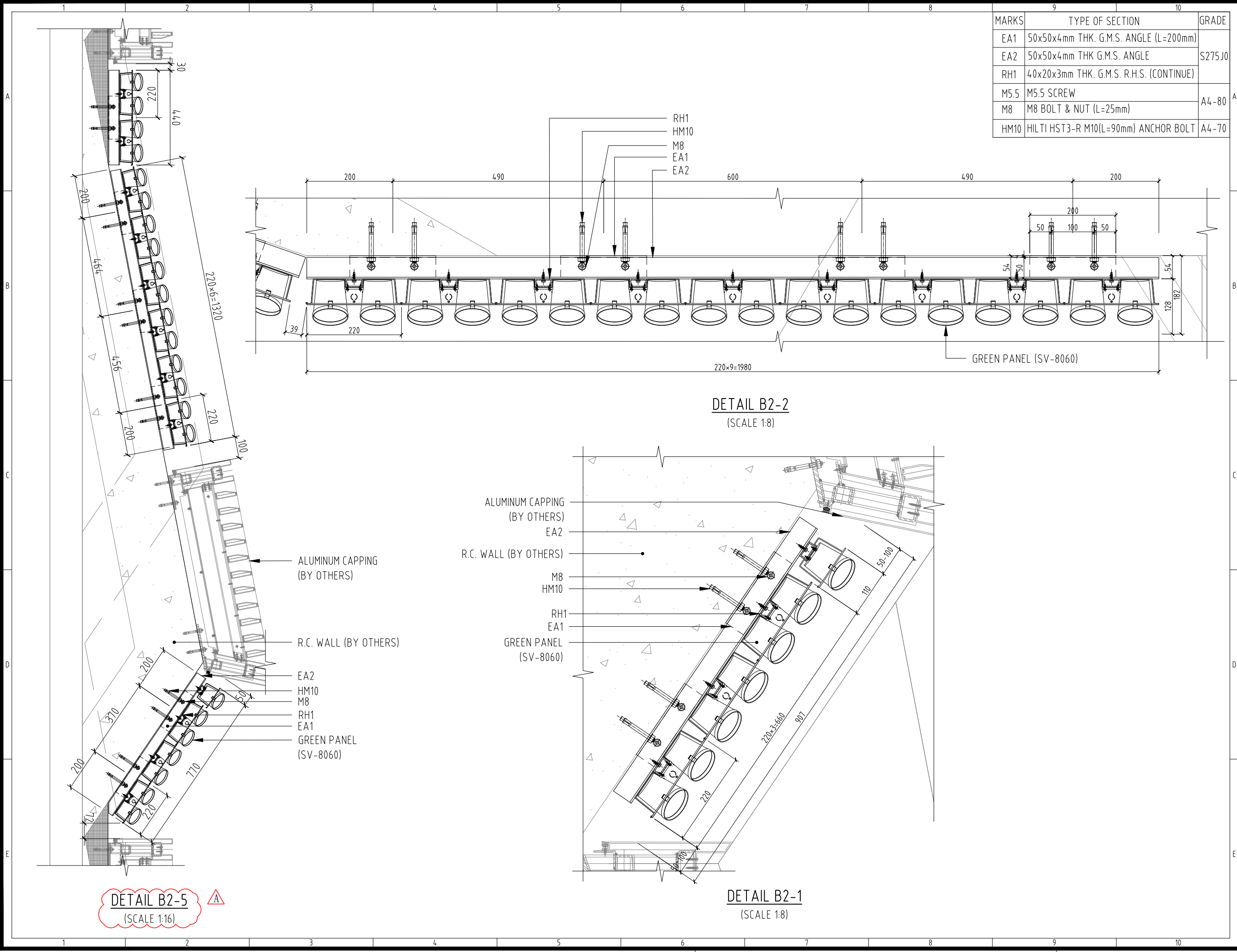

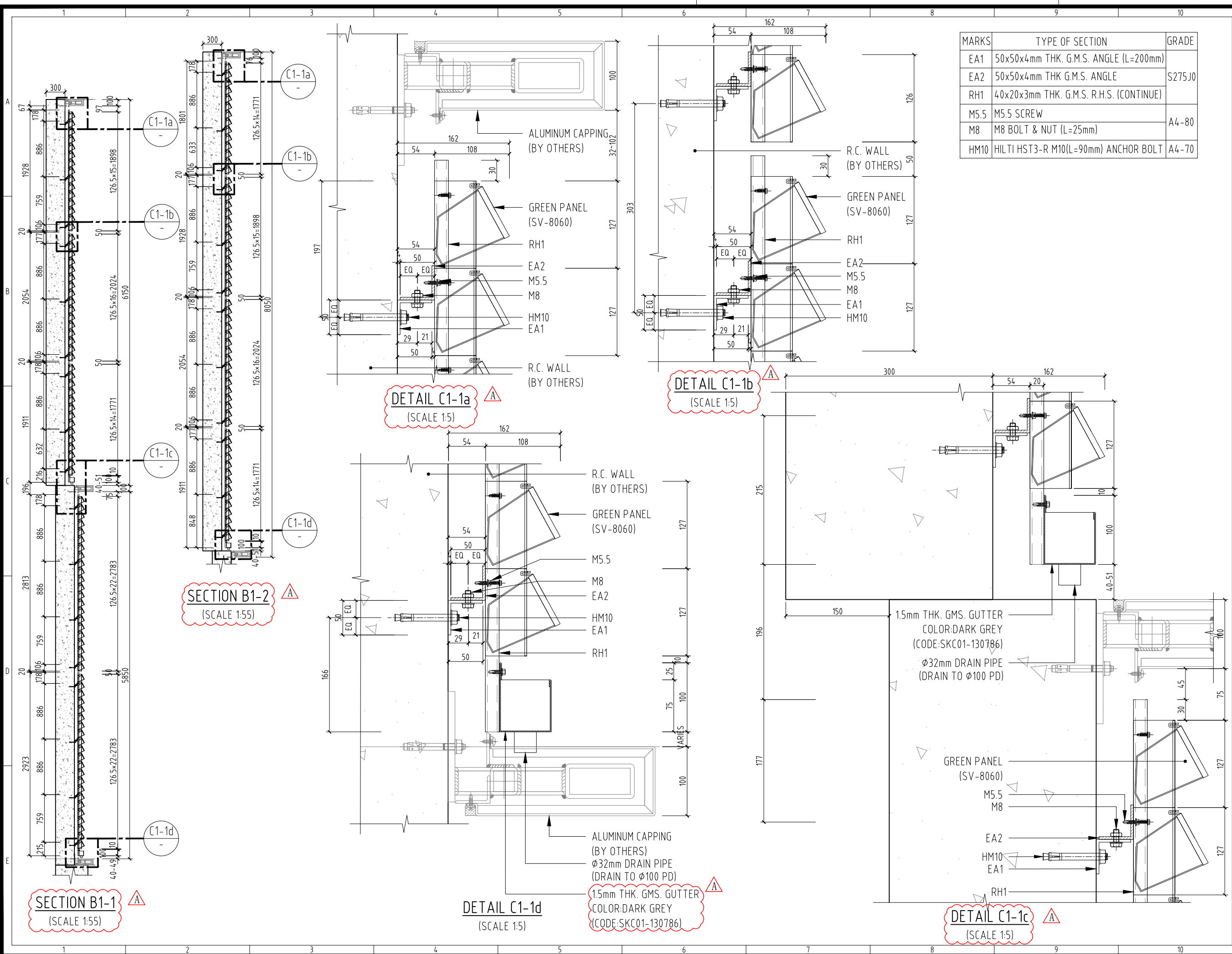

MARKS	TYPE OF SECTION	GRADE
EA1	50x50x4mm THK. G.M.S. ANGLE (L=200mm)	S275 J0
EA2	50x50x4mm THK G.M.S. ANGLE	
RH1	40x20x3mm THK. G.M.S. R.H.S. (CONTINUE)	A4-80
M5.5	M5.5 SCREW	
M8	M8 BOLT & NUT (L=25mm)	A4-70
HM10	HILTI HST3-R M10(L=90mm) ANCHOR BOLT	

CAD FILE:
SIC20-024-VG02e-g-101

REV.	DESCRIPTION	DATE
-		15.09.20
A	DESIGN REVISED	21.01.21

CLIENT:

ARCHITECT:

LANDSCAPE ARCHITECT:

STRUCTURAL ENGINEER:

E & M CONTRACTOR:

MAIN CONTRACTOR:

SUB CONTRACTOR:

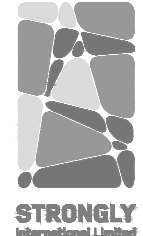

STRONGLY International Limited

TEL: 3696 6688 FAX: 3696 6699
EMAIL: strongly@hkvgl.com

Copyright Strongly International Limited.
All rights reserved.

DRAWN	CHECKED	APPROVED
HUA	YANG	LEE

DATE: 09-04-2021

PROJECT No. SIC20-024

PROJECT
GREEN WALL SYSTEM AT TSING YI TOWN LOT 190 SAI SHAN ROAD

TITLE
GREEN WALL (VG02e-g)
- SECTION & DETAILS

SCALE: 1:250 OR AS STATED

DRAWING NUMBER
SIC20-024-VG02e-g-107

DRF210335D REV. A

ALL DIMENSIONS IN mm
A3 SIZE (420 x 297)
DO NOT SCALE

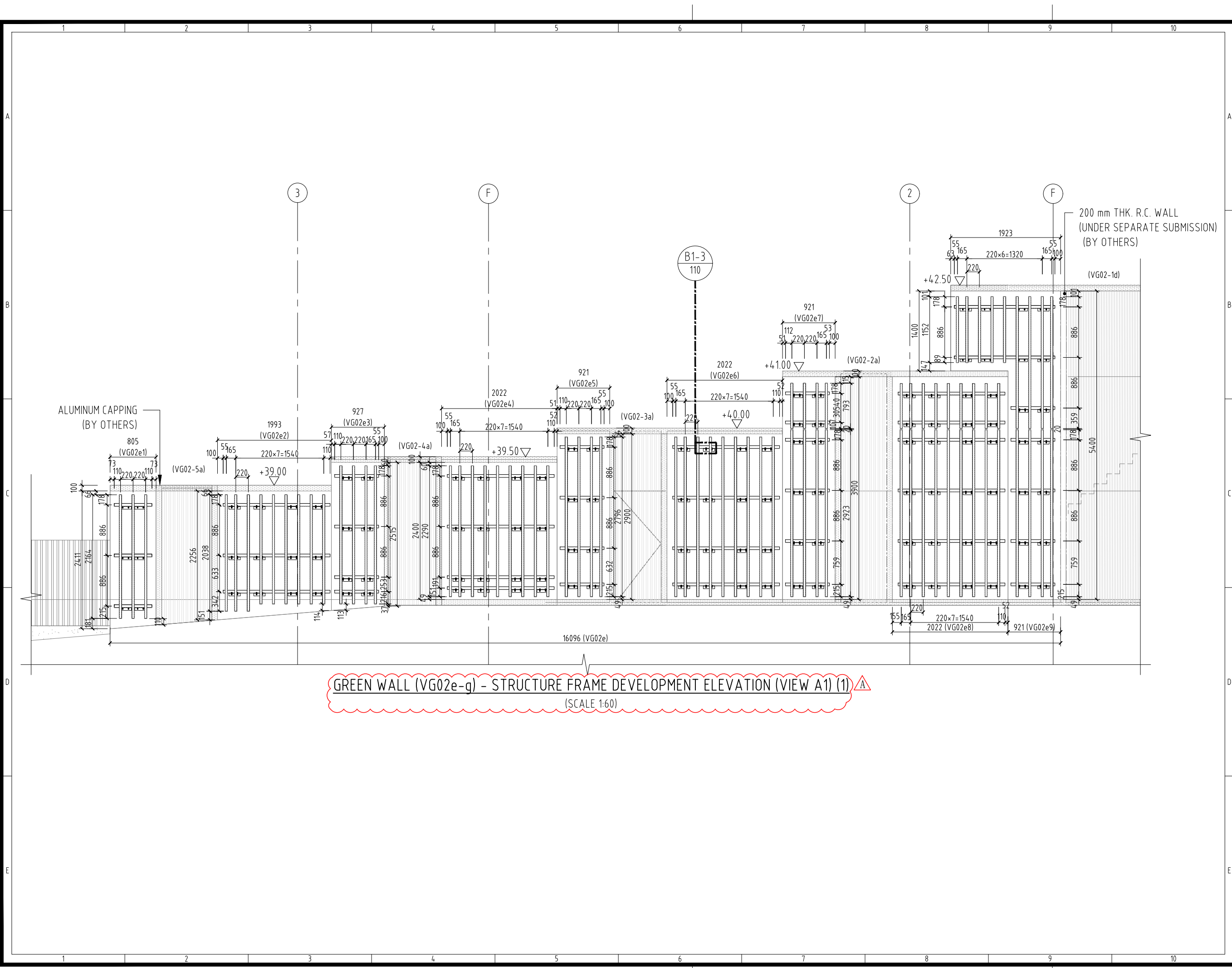

GREEN WALL (VG02e-g) - STRUCTURE FRAME DEVELOPMENT ELEVATION (VIEW A1) (1) A
(SCALE 1:60)

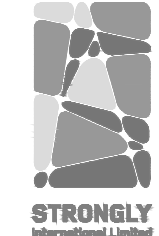
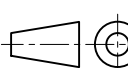
CAD FILE: SIC20-024-VG02e-g-101		
REV.	DESCRIPTION	DATE
-		09.04.21
CLIENT:		
ARCHITECT:		
LANDSCAPE ARCHITECT:		
STRUCTURAL ENGINEER:		
E & M CONTRACTOR:		
MAIN CONTRACTOR:		
SUB CONTRACTOR:		
 STRONGLY <small>International Limited</small>		
TEL: 3696 6688 FAX: 3696 6699 EMAIL: strongly@hkvgl.com		
Copyright Strongly International Limited. All rights reserved.		
DRAWN	CHECKED	APPROVED
HUA	YANG	LEE
DATE	09-04-2021	
PROJECT No.	SIC20-024	
PROJECT GREEN WALL SYSTEM AT TSING YI TOWN LOT 190 SAI SHAN ROAD		
TITLE GREEN WALL (VG02e-g) - ELEVATION		
SCALE	1: 155 OR AS STATED	
DRAWING NUMBER SIC20-024-VG02e-g-108		
DRF210335D	REV. -	
		
ALL DIMENSIONS IN mm A3 SIZE (420 x 297) DO NOT SCALE		

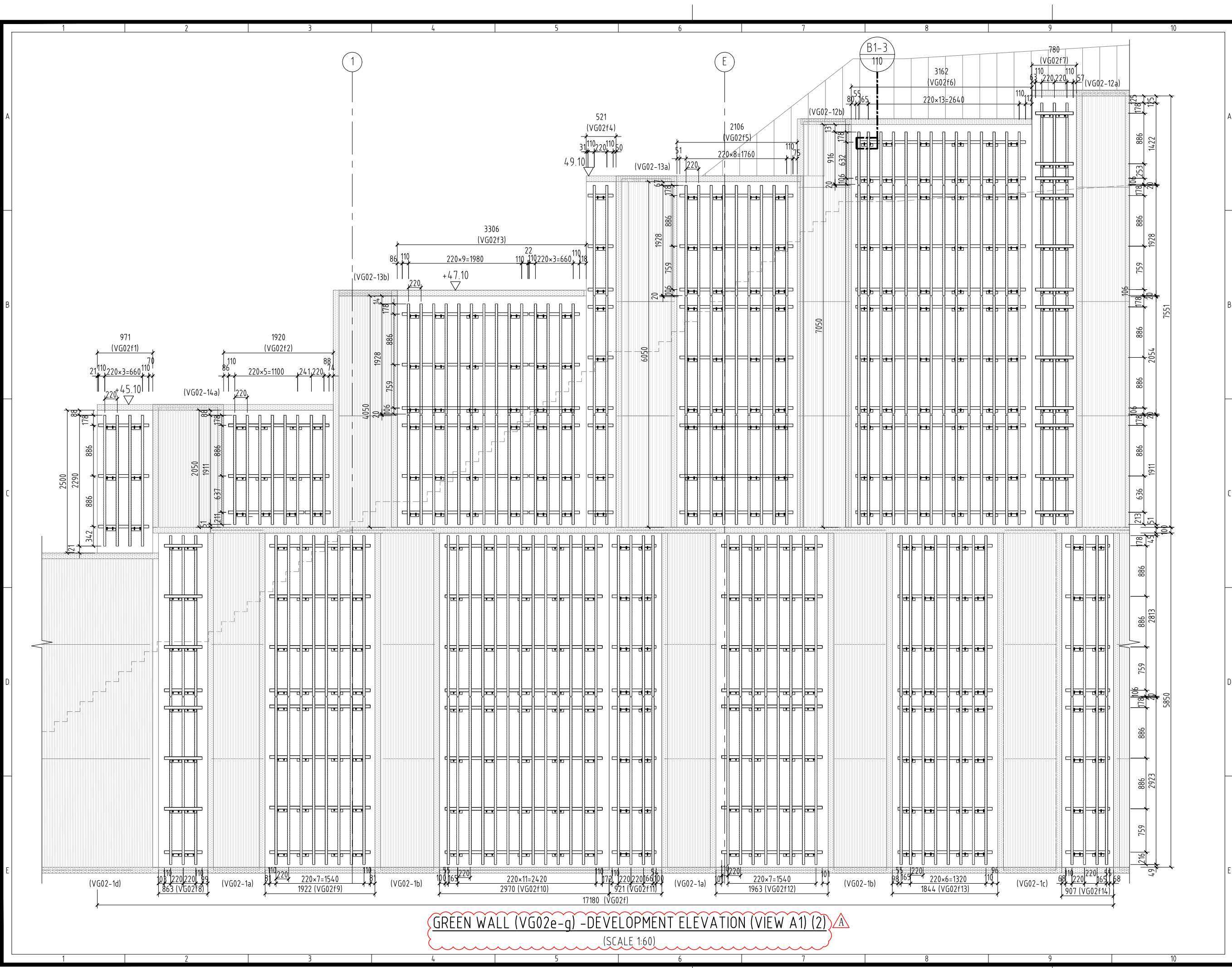

CAD FILE:
SIC20-024-VG02e-g-101

REV.	DESCRIPTION	DATE
-		210121

CLIENT:

ARCHITECT:

LANDSCAPE ARCHITECT:

STRUCTURAL ENGINEER:

E & M CONTRACTOR:

MAIN CONTRACTOR:

SUB CONTRACTOR:

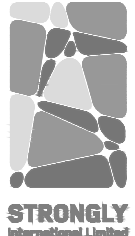

STRONGLY
International Limited

TEL: 3696 6688 FAX: 3696 6699
EMAIL: strongly@hkvgl.com

Copyright Strongly International Limited.
All rights reserved.

DRAWN	CHECKED	APPROVED
HUA	YANG	LEE

DATE: 09-04-2021

PROJECT No. SIC20-024

PROJECT
GREEN WALL SYSTEM AT TSING YI
TOWN LOT 190 SAI SHAN ROAD

TITLE
GREEN WALL (VG02e-g)
- ELEVATION

SCALE: 1:155 OR AS STATED

DRAWING NUMBER
SIC20-024-VG02e-g-109

DRF210335D REV. A

ALL DIMENSIONS IN mm
A3 SIZE (420 x 297)
DO NOT SCALE

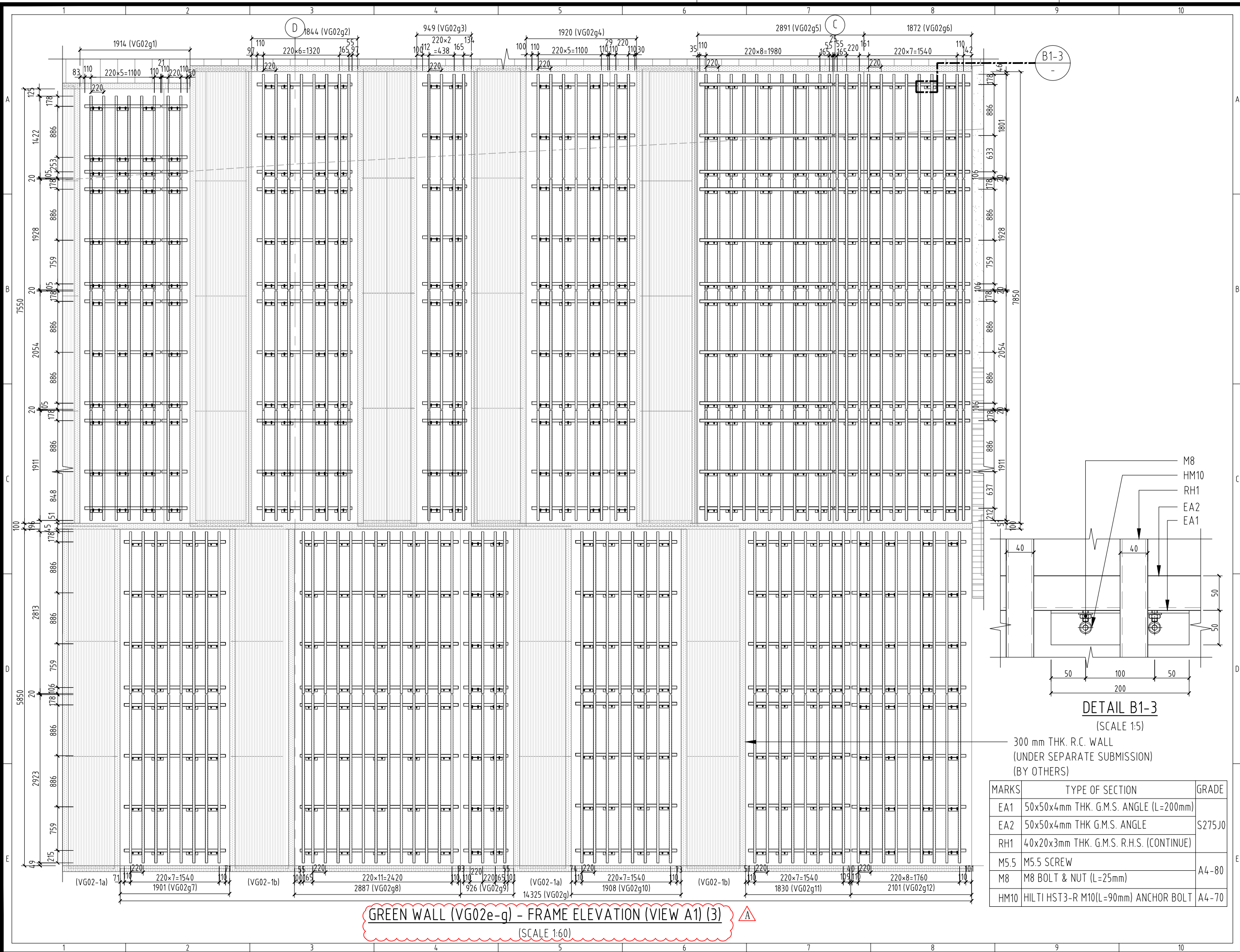

GREEN WALL (VG02e-g) - FRAME ELEVATION (VIEW A1) (3)
 (SCALE 1:60)

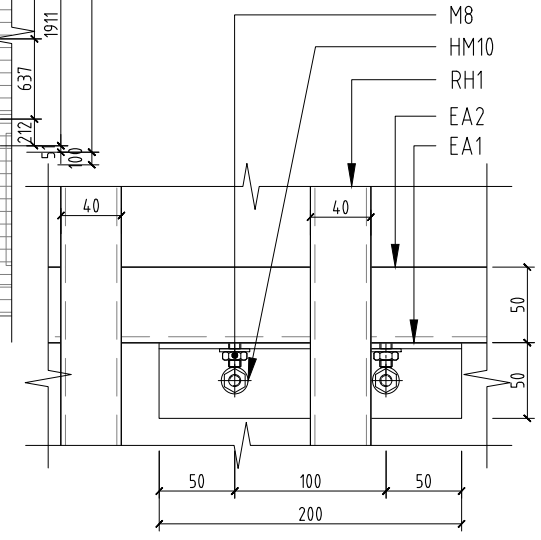

DETAIL B1-3
 (SCALE 1:5)

300 mm THK. R.C. WALL
 (UNDER SEPARATE SUBMISSION)
 (BY OTHERS)

MARKS	TYPE OF SECTION	GRADE
EA1	50x50x4mm THK. G.M.S. ANGLE (L=200mm)	S275J0
EA2	50x50x4mm THK G.M.S. ANGLE	
RH1	40x20x3mm THK. G.M.S. R.H.S. (CONTINUE)	
M5.5	M5.5 SCREW	A4-80
M8	M8 BOLT & NUT (L=25mm)	A4-70
HM10	HILTI HST3-R M10(L=90mm) ANCHOR BOLT	

CAD FILE:
SIC20-024-VG02e-g-101

REV.	DESCRIPTION	DATE
-		09.04.21

CLIENT:

ARCHITECT:

LANDSCAPE ARCHITECT:

STRUCTURAL ENGINEER:

E & M CONTRACTOR:

MAIN CONTRACTOR:

SUB CONTRACTOR:

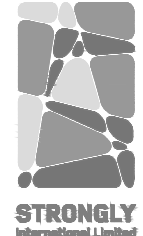

STRONGLY
International Limited

TEL: 3696 6688 FAX: 3696 6699
 EMAIL: strongly@hkvgl.com

Copyright Strongly International Limited.
 All rights reserved.

DRAWN	CHECKED	APPROVED
HUA	YANG	LEE

DATE: 09-04-2021

PROJECT No. SIC20-024

PROJECT
 GREEN WALL SYSTEM AT TSING YI
 TOWN LOT 190 SAI SHAN ROAD

TITLE
**GREEN WALL (VG02e-g)
 - ELEVATION**



SCALE: 1:155 OR AS STATED

DRAWING NUMBER
SIC20-024-VG02e-g-110

DRF210335D REV. -

ALL DIMENSIONS IN mm
 A3 SIZE (420 x 297)
 DO NOT SCALE

LEGEND:

	φ20mm UPVC PIPE
	φ17mm IRRIGATION PIPE
	EMITTER

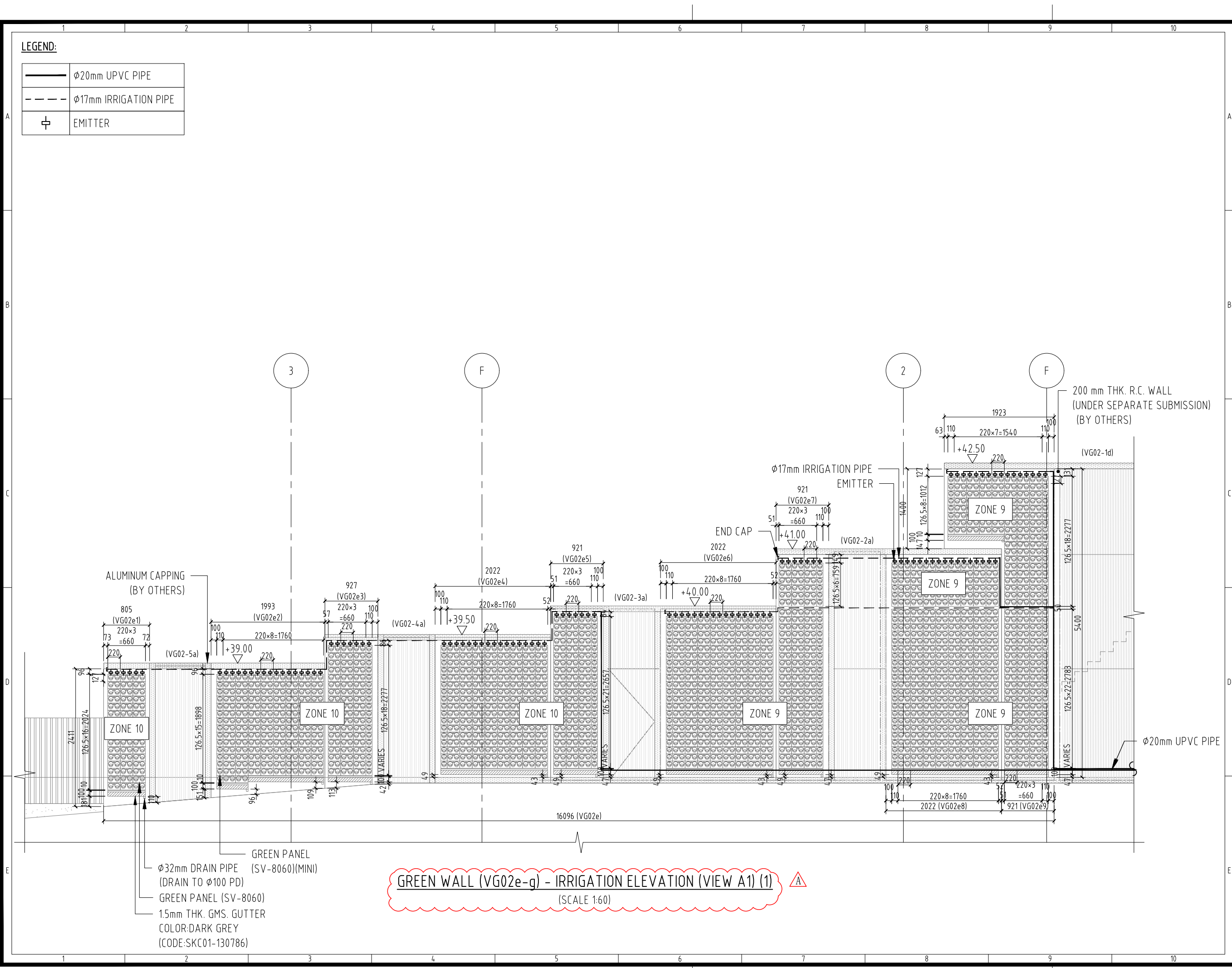

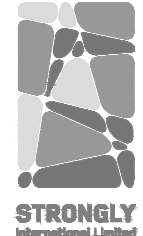
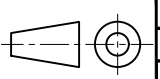

GREEN WALL (VG02e-g) - IRRIGATION ELEVATION (VIEW A1) (1)
(SCALE 1:60)

- GREEN PANEL (SV-8060)(MINI)
- φ32mm DRAIN PIPE (SV-8060)(MINI) (DRAIN TO φ100 PD)
- GREEN PANEL (SV-8060)
- 1.5mm THK. GMS. GUTTER COLOR:DARK GREY (CODE:SKC01-130786)

CAD FILE: SIC20-024-VG02e-g-101		
REV.	DESCRIPTION	DATE
-		09.04.21
CLIENT:		
ARCHITECT:		
LANDSCAPE ARCHITECT:		
STRUCTURAL ENGINEER:		
E & M CONTRACTOR:		
MAIN CONTRACTOR:		
SUB CONTRACTOR:		
 STRONGLY <small>International Limited</small>		
TEL: 3696 6688 FAX: 3696 6699 EMAIL: strongly@hkvgl.com		
Copyright Strongly International Limited. All rights reserved.		
DRAWN	CHECKED	APPROVED
HUA	YANG	LEE
DATE	09-04-2021	
PROJECT No.	SIC20-024	
PROJECT GREEN WALL SYSTEM AT TSING YI TOWN LOT 190 SAI SHAN ROAD		
TITLE GREEN WALL (VG02e-g) - IRRIGATION ELEVATION		
SCALE	1:155 OR AS STATED	
DRAWING NUMBER SIC20-024-VG02e-g-111		
DRF210335D	REV. -	
		
ALL DIMENSIONS IN mm A3 SIZE (420 x 297) DO NOT SCALE		

LEGEND:

	Ø20mm UPVC PIPE
	Ø17mm IRRIGATION PIPE
	EMITTER

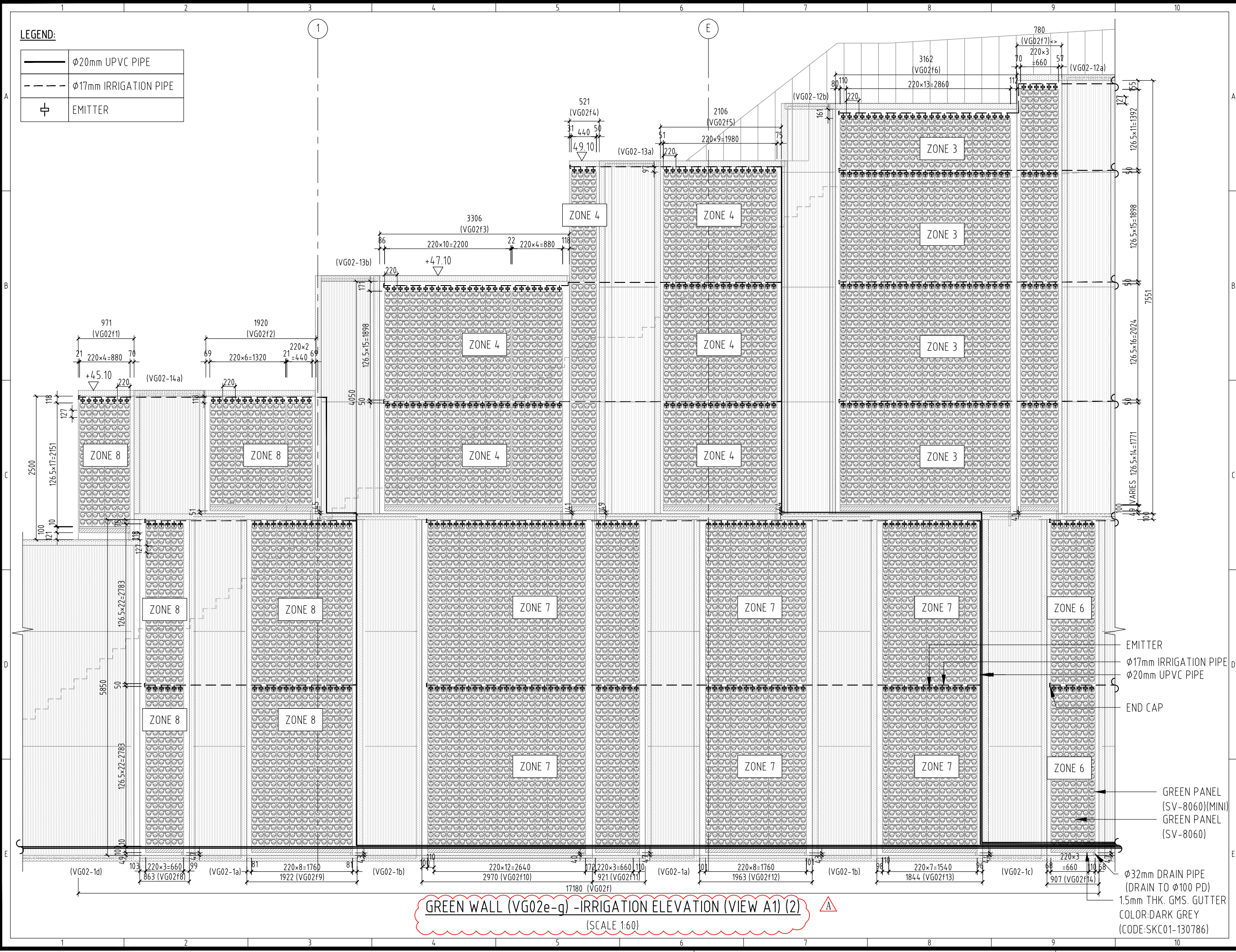

GREEN WALL (VG02e-g) - IRRIGATION ELEVATION (VIEW A1) (2)
 (SCALE 1:60)

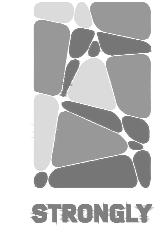
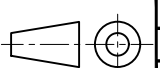
CAD FILE: SIC20-024-VG02e-g-101		
REV.	DESCRIPTION	DATE
-		09.04.21
CLIENT:		
ARCHITECT:		
LANDSCAPE ARCHITECT:		
STRUCTURAL ENGINEER:		
E & M CONTRACTOR:		
MAIN CONTRACTOR:		
SUB CONTRACTOR:		
 STRONGLY <small>International Limited</small>		
TEL: 3696 6688 FAX: 3696 6699 EMAIL: strongly@hkvgl.com		
Copyright Strongly International Limited. All rights reserved.		
DRAWN	CHECKED	APPROVED
HUA	YANG	LEE
DATE		09-04-2021
PROJECT No. SIC20-024		
PROJECT GREEN WALL SYSTEM AT TSING YI TOWN LOT 190 SAI SHAN ROAD		
TITLE GREEN WALL (VG02e-g) - IRRIGATION ELEVATION		
SCALE 1: 155 OR AS STATED		
DRAWING NUMBER SIC20-024-VG02e-g-112		
DRF210335D		REV. -
		
ALL DIMENSIONS IN mm A3 SIZE (420 x 297) DO NOT SCALE		

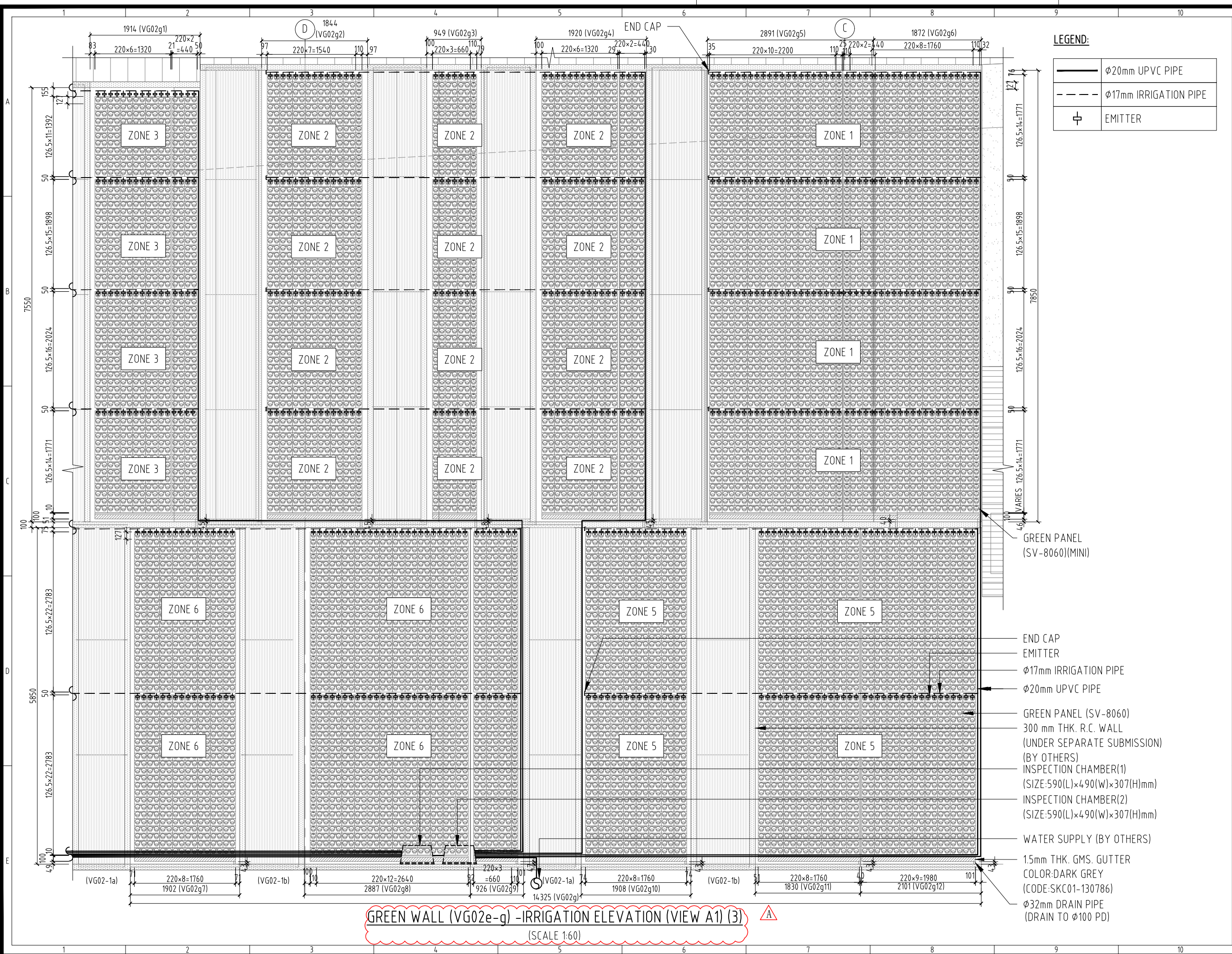

LEGEND:

	φ20mm UPVC PIPE
	φ17mm IRRIGATION PIPE
	EMITTER

- GREEN PANEL (SV-8060)(MINI)
- END CAP
- EMITTER
- φ17mm IRRIGATION PIPE
- φ20mm UPVC PIPE
- GREEN PANEL (SV-8060)
- 300 mm THK. R.C. WALL (UNDER SEPARATE SUBMISSION)
- INSPECTION CHAMBER(1) (SIZE:590(L)×490(W)×307(H)mm)
- INSPECTION CHAMBER(2) (SIZE:590(L)×490(W)×307(H)mm)
- WATER SUPPLY (BY OTHERS)
- 15mm THK. GMS. GUTTER
- COLOR:DARK GREY (CODE:SKC01-130786)
- φ32mm DRAIN PIPE (DRAIN TO φ100 PD)

GREEN WALL (VG02e-g) -IRRIGATION ELEVATION (VIEW A1) (3)

(SCALE 1:60)

CAD FILE:
SIC20-024-VG02e-g-101

REV.	DESCRIPTION	DATE
-		09.04.21

CLIENT:

ARCHITECT:

LANDSCAPE ARCHITECT:

STRUCTURAL ENGINEER:

E & M CONTRACTOR:

MAIN CONTRACTOR:

SUB CONTRACTOR:

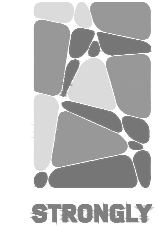

STRONGLY
International Limited

TEL: 3696 6688 FAX: 3696 6699
EMAIL: strongly@hkvgl.com

Copyright Strongly International Limited.
All rights reserved.

DRAWN	CHECKED	APPROVED
HUA	YANG	LEE

DATE: 09-04-2021

PROJECT No. SIC20-024

PROJECT
GREEN WALL SYSTEM AT TSING YI TOWN LOT 190 SAI SHAN ROAD

TITLE
GREEN WALL (VG02e-g) - IRRIGATION ELEVATION

SCALE: 1:155 OR AS STATED

DRAWING NUMBER
SIC20-024-VG02e-g-113

DRF210335D REV. -

ALL DIMENSIONS IN mm
A3 SIZE (420 x 297)
DO NOT SCALE

LEGEND:

	WATER SUPPLY (BY OTHERS)
	GATE VALVE
	Y-STRAINER
	NON-RETURN VALVE
	Y-STRAINER (COPPER)
	PRESSURE REGULATOR WITH PRESSURE GAUGE
	TIMER CONTROLLER
	φ20mm UPVC PIPE
	φ17mm IRRIGATION PIPE
	EMITTER

WATER IRRIGATION MAIN REQUIREMENT

- FLOW RATE : 1.0 LITER / SECOND (MINIMUM)
- PRESSURE : 3.5-4 BAR AT WORKING LEVEL

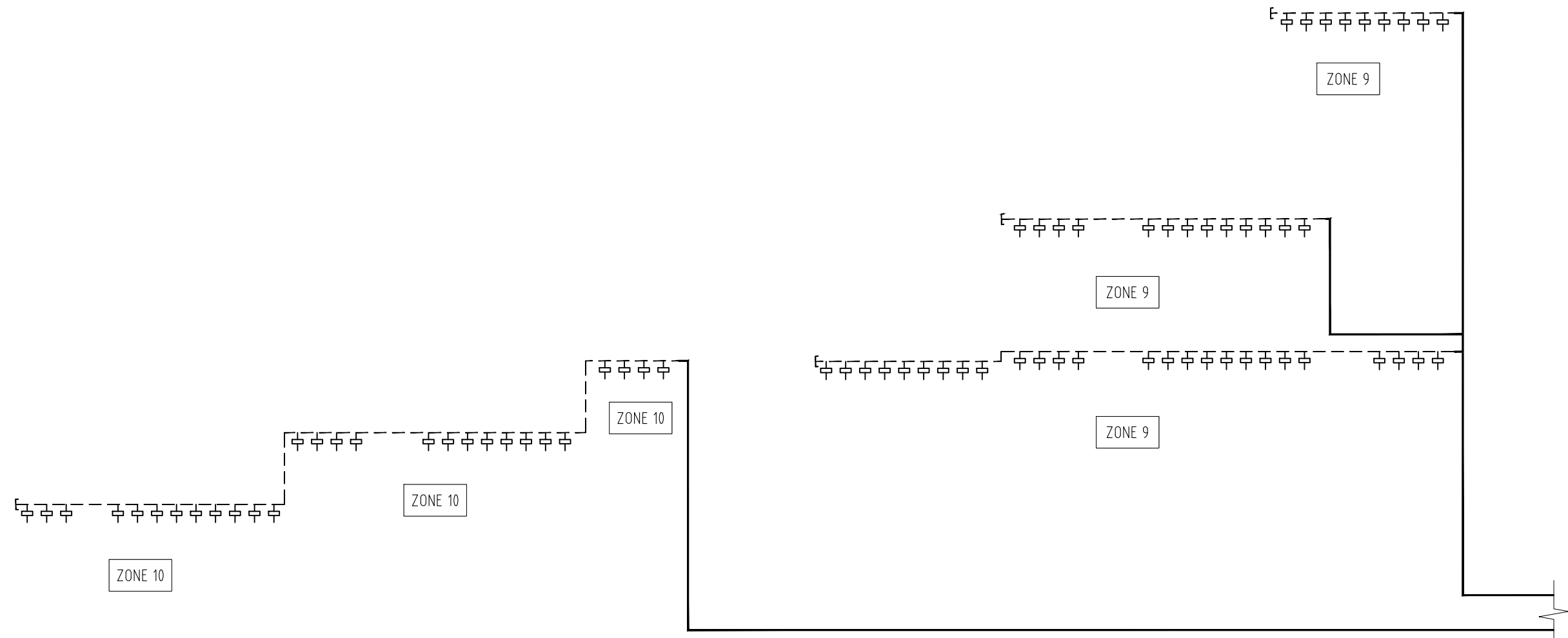

SCHEMATIC DIAGRAM OF AUTOMATIC IRRIGATION SYSTEM (1)

CAD FILE: SIC20-024-VG02e-g-101		
REV.	DESCRIPTION	DATE
-		09.04.21
CLIENT:		
ARCHITECT:		
LANDSCAPE ARCHITECT:		
STRUCTURAL ENGINEER:		
E & M CONTRACTOR:		
MAIN CONTRACTOR:		
SUB CONTRACTOR:		
 STRONGLY <small>International Limited</small>		
TEL: 3696 6688 FAX: 3696 6699 EMAIL: strongly@hkvgl.com		
Copyright Strongly International Limited. All rights reserved.		
DRAWN	CHECKED	APPROVED
HUA	YANG	LEE
DATE	09-04-2021	
PROJECT No.	SIC20-024	
PROJECT GREEN WALL SYSTEM AT TSING YI TOWN LOT 190 SAI SHAN ROAD		
TITLE SCHEMATIC DIAGRAM OF AUTOMATIC IRRIGATION SYSTEM (1)		
SCALE	N.T.S	
DRAWING NUMBER SIC20-024-VG2-114		
DRF210335D	REV. -	
ALL DIMENSIONS IN mm A3 SIZE (420 x 297) DO NOT SCALE		

LEGEND:

	WATER SUPPLY (BY OTHERS)
	GATE VALVE
	Y-STRAINER
	NON-RETURN VALVE
	Y-STRAINER (COPPER)
	PRESSURE REGULATOR WITH PRESSURE GAUGE
	TIMER CONTROLLER
	φ20mm UPVC PIPE
	φ17mm IRRIGATION PIPE
	EMITTER

WATER IRRIGATION MAIN REQUIREMENT

- FLOW RATE : 1.0 LITER / SECOND (MINIMUM)
- PRESSURE : 3.5-4 BAR AT WORKING LEVEL

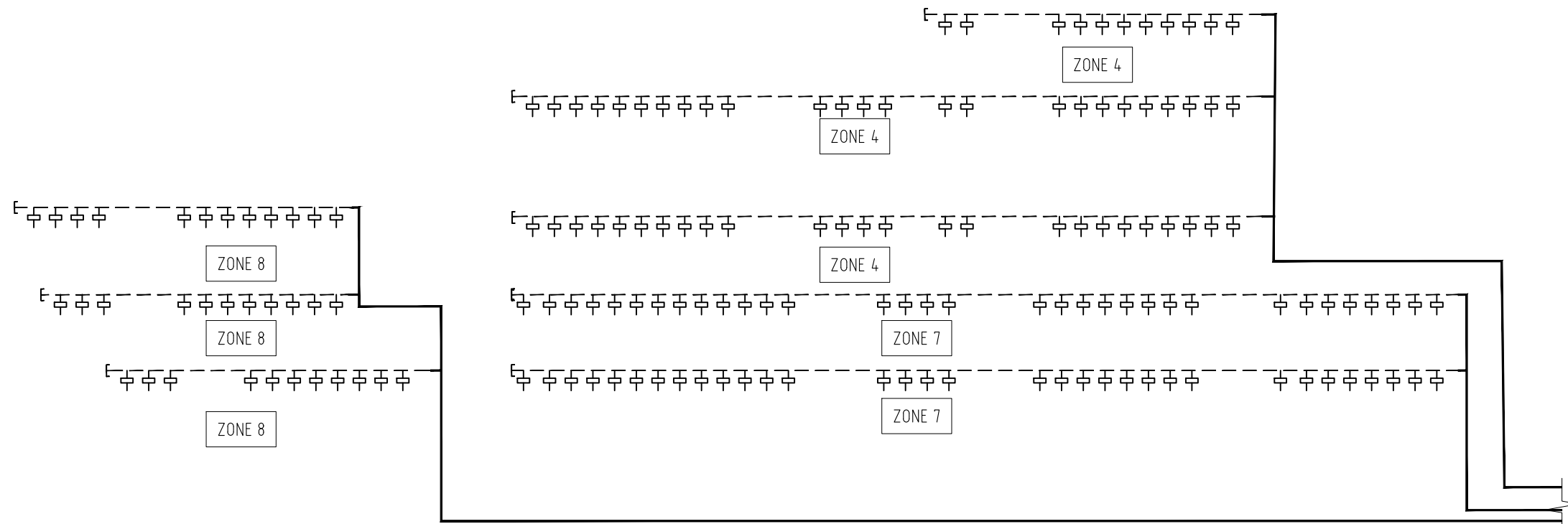

VG2f

SCHEMATIC DIAGRAM OF AUTOMATIC IRRIGATION SYSTEM (2)



CAD FILE:
SIC20-024-VG02e-g-101

REV.	DESCRIPTION	DATE
-		09.04.21

CLIENT:
ARCHITECT:
LANDSCAPE ARCHITECT:
STRUCTURAL ENGINEER:

E & M CONTRACTOR:

MAIN CONTRACTOR:

SUB CONTRACTOR:



STRONGLY
International Limited

TEL: 3696 6688 FAX: 3696 6699
EMAIL: strongly@hkvgl.com

Copyright Strongly International Limited.
All rights reserved.

DRAWN	CHECKED	APPROVED
HUA	YANG	LEE

DATE: 09-04-2021

PROJECT No. SIC20-024

PROJECT
GREEN WALL SYSTEM AT TSING YI
TOWN LOT 190 SAI SHAN ROAD

TITLE
**SCHEMATIC DIAGRAM OF
AUTOMATIC IRRIGATION SYSTEM (2)**

SCALE: N.T.S.

DRAWING NUMBER
SIC20-024-VG2-115

DRF210335D REV. -

ALL DIMENSIONS IN mm
A3 SIZE (420 x 297)
DO NOT SCALE

LEGEND:

	WATER SUPPLY (BY OTHERS)
	GATE VALVE
	Y-STRAINER
	NON-RETURN VALVE
	Y-STRAINER (COPPER)
	PRESSURE REGULATOR WITH PRESSURE GAUGE
	TIMER CONTROLLER
	φ20mm UPVC PIPE
	φ17mm IRRIGATION PIPE
	EMITTER

WATER IRRIGATION MAIN REQUIREMENT

- FLOW RATE : 1.0 LITER / SECOND (MINIMUM)
- PRESSURE : 3.5-4 BAR AT WORKING LEVEL

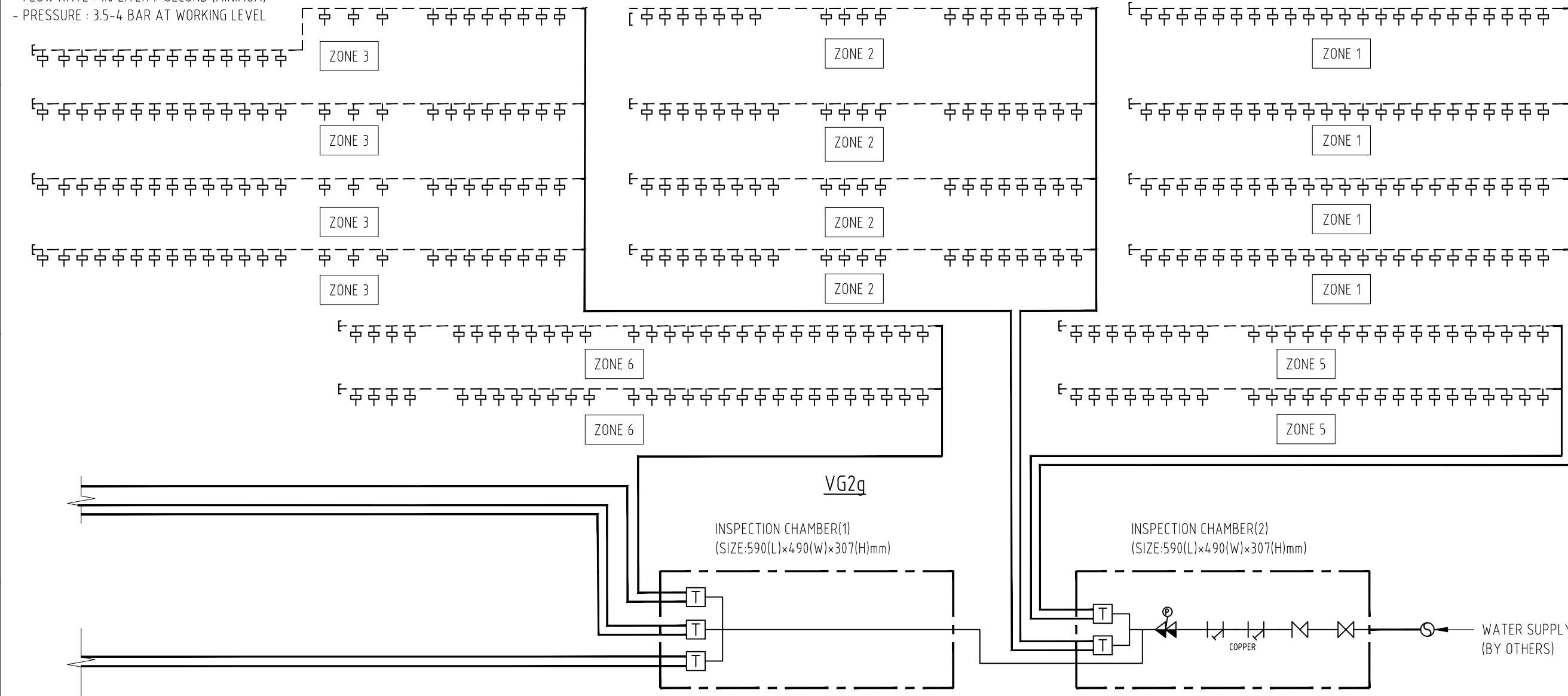

SCHEMATIC DIAGRAM OF AUTOMATIC IRRIGATION SYSTEM (3)

CAD FILE:
SIC20-024-VG02e-g-101

REV.	DESCRIPTION	DATE
-		09.04.21

CLIENT:

ARCHITECT:

LANDSCAPE ARCHITECT:

STRUCTURAL ENGINEER:

E & M CONTRACTOR:

MAIN CONTRACTOR:

SUB CONTRACTOR:

STRONGLY
International Limited

TEL: 3696 6688 FAX: 3696 6699
EMAIL: strongly@hkvgl.com

Copyright Strongly International Limited.
All rights reserved.

DRAWN	CHECKED	APPROVED
HUA	YANG	LEE

DATE: 09-04-2021

PROJECT No. SIC20-024

PROJECT
GREEN WALL SYSTEM AT TSING YI
TOWN LOT 190 SAI SHAN ROAD

TITLE
**SCHEMATIC DIAGRAM OF
AUTOMATIC IRRIGATION SYSTEM (3)**

SCALE: N.T.S.

DRAWING NUMBER
SIC20-024-VG2-116

DRF210335D REV. -

ALL DIMENSIONS IN mm
A3 SIZE (420 x 297)
DO NOT SCALE