



工程指示 / 要求簡箋(E.I.)

工程指示編號：EI/ 2244 /20 修改版次：
 工程編號：J851 工程名稱：青衣明翹滙
 工程項目：露台欄河地盤用鐵件
 收件人：Maggie Lor 發件人：Joe Chan 日期：5/8/2020

要求提供 / 確認 事項：

- | | | |
|------------------------------------|-------------------------------------|-------------------------------|
| <input type="checkbox"/> 初步鋁料 B.M. | <input type="checkbox"/> 加工拆圖，然後生產 | <input type="checkbox"/> 尺寸表 |
| <input type="checkbox"/> 正式鋁料 B.M. | <input type="checkbox"/> 技術上資料 / 指示 | <input type="checkbox"/> 報價 |
| <input type="checkbox"/> 配件 B.M. | <input type="checkbox"/> 樣辦或貨品說明書 | <input type="checkbox"/> 分判合約 |
| <input type="checkbox"/> 其他：_____ | | |

內容：

請依附件資料，生產 GMS 鐵件，按地盤要求分批送地盤。(每5層出貨一次)。
 第一批：1/F - 6/F 請於 20/8/2020 出貨。

請在 30/9/2020 前完成上列要求。

附有關圖紙 / 文件：

1 + 16 頁

以上項目為：

- 原合約工程包 原合約工程加 / 減賬 新工程報價

原因：-

分發東莞各部門：

- () 生產技術總監 連附件 () 技術部 連附件 () 生產部 連附件 () 機械設計部 連附件
 () 採購部 連附件 () 生產統籌部 連附件
 () 質檢部 連附件 () 會計部 連附件 () 報關組 連附件 () 其他 _____ 連附件

分發香港各部門：

- () 行政部 連附件 () 會計部 連附件 () 統籌部 連附件 () 工程地盤科文 連附件 積哥
 () 採購部 連附件 () QS 部 連附件 () 維修部 連附件 () 其他 _____ 連附件

傳遞編號：

發件人簽署：

項目經理簽署：

①



美特鋁質有限公司
MTD1 Aluminium Fabricator Ltd.

工程號: J-851

計算: XYB/SAM

日期: 27/7/2020

送呈:

地盤名稱: TYTTL190 青衣明匯

核對: JOE

日期: 30/7/2020

副本:

項目類別:

批准:

日期:

BM編號:

修改版次:

A/C Code:

鐵件總重量KG:

44608.79

序號	修改內容	鐵件圖號	鐵件名稱	顏色	實用	後備	總數	單位	單件 (kg)	總重量 (kg)	備注
1		ST-AN01	75x50x6 角碼	熱浸鋅	7688	300	7988	件	0.559	4465.292	
2		ST-AN02-01	75x50x6 角鐵	熱浸鋅	769	0	769	件	11.230	8635.870	
3		ST-AN02-02	75x50x6 角鐵	熱浸鋅	201	0	201	件	8.380	1684.380	
4		ST-AN02-03	75x50x6 角鐵	熱浸鋅	968	0	968	件	5.360	5188.480	
5		ST-AN02-04	75x50x6 角鐵	熱浸鋅	853	0	853	件	2.460	2098.380	
6		ST-AN02-05	75x50x6 角鐵	熱浸鋅	88	0	88	件	4.250	374.000	
7		ST-AN03-01	75x50x6 角鐵	熱浸鋅	769	0	769	件	11.230	8635.870	
8		ST-AN03-02	75x50x6 角鐵	熱浸鋅	201	0	201	件	8.380	1684.380	
9		ST-AN03-03	75x50x6 角鐵	熱浸鋅	968	0	968	件	5.360	5188.480	
10		ST-AN03-04	75x50x6 角鐵	熱浸鋅	853	0	853	件	2.460	2098.380	
11		ST-AN03-05	75x50x6 角鐵	熱浸鋅	88	0	88	件	4.250	374.000	
12		ST-AN04-01	100x50x5 槽鐵	熱浸鋅	58	0	58	件	2.040	118.320	使用10.2KG/M款式槽鐵
13		ST-AN04-02	100x50x5 槽鐵	熱浸鋅	825	0	825	件	3.672	3029.400	使用10.2KG/M款式槽鐵
14		ST-AN04-03	100x50x5 槽鐵	熱浸鋅	56	0	56	件	6.732	376.992	使用10.2KG/M款式槽鐵
15		ST-AN05-01	40x25x4 角鐵	熱浸鋅	58	0	58	件	0.380	22.040	
16		ST-AN05-02	40x25x4 角鐵	熱浸鋅	825	0	825	件	0.684	564.300	
17		ST-AN05-03	40x25x4 角鐵	熱浸鋅	56	0	56	件	1.254	70.224	
					合計:		15624	件	合共:	44608.788	

3

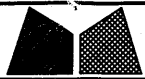
 美特鋁質有限公司 MIDI Aluminium Fabricator Ltd.				工程號	J851	類別		物料號	-					
				地盘	青衣190	制圖	W. E. X	2020-05-13	圖號	ST-AN01				
修改	-	-	-	採用工廠		地盤	✓	图纸名称	铁件加工图	復核	-	-	數量	7688 + 300
日期	-	-	-	材料颜色	热浸锌	材料	75x50x6mm铁角	批准	-	-	單件重量	0.559	(KG)	

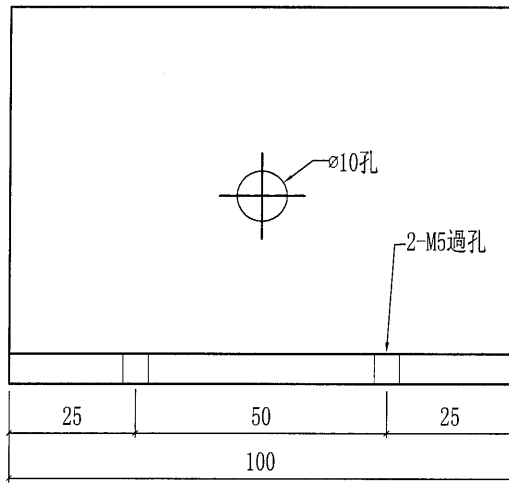

此面刷漆

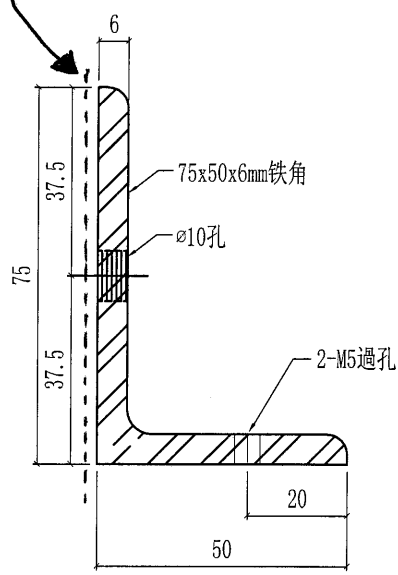

每個露台8隻，分佈示意圖

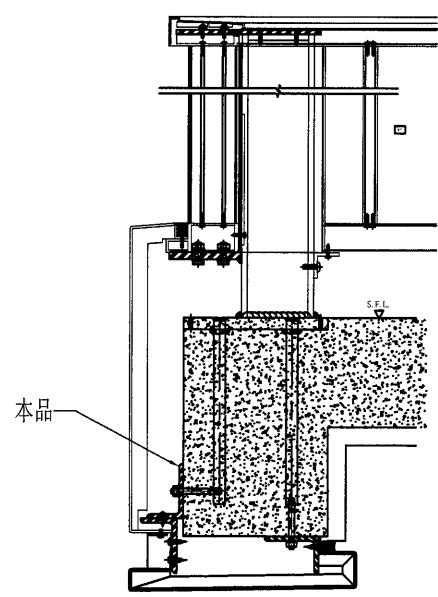
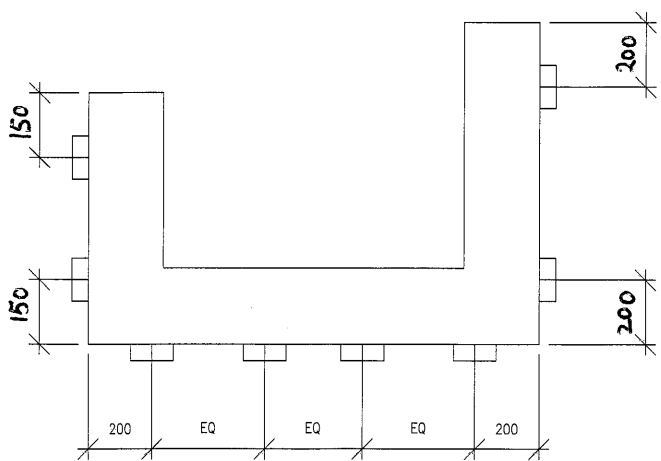

4



美特鋁質有限公司
MIDI Aluminium Fabricator Ltd.

工程號	J851	類別		物料號	-		
地盘	青衣190	制圖	W. E. X	2020-05-13	圖號	ST-AN02	
修改	-	採用工廠		地盤	✓	圖紙名稱	铁件加工图
日期	-	材料颜色	热浸锌	材料	75x50x6mm铁角	復核	-
						批准	-
						數量	-
						單件重量	- (KG)

铁件编号	L	数量	单件重量(kg)
ST-AN02-01	2000	70	11.23
ST-AN02-02	1500	201	8.38
ST-AN02-03	960	968	5.36
ST-AN02-04	440	853	2.46
ST-AN02-05	700	88	4.25

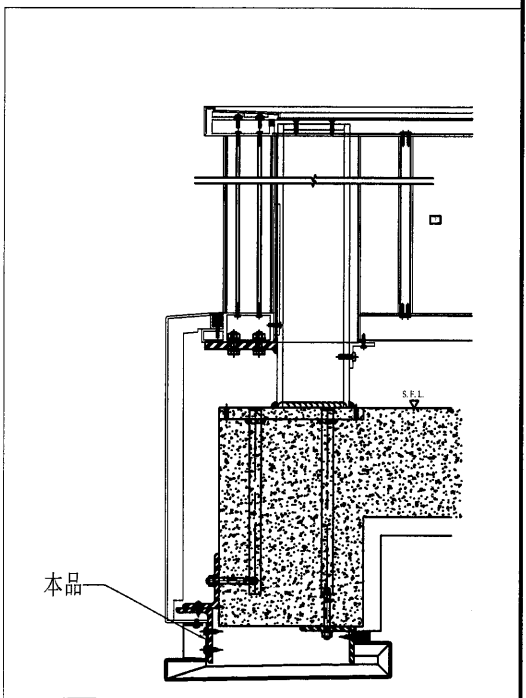
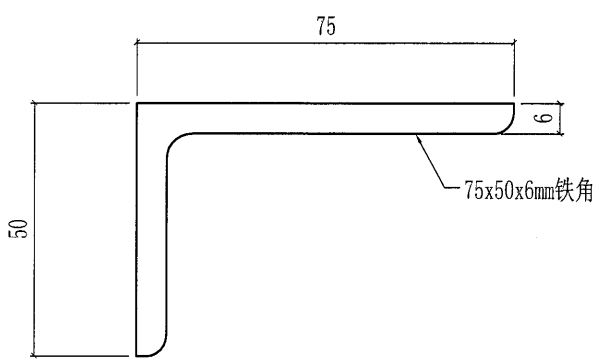
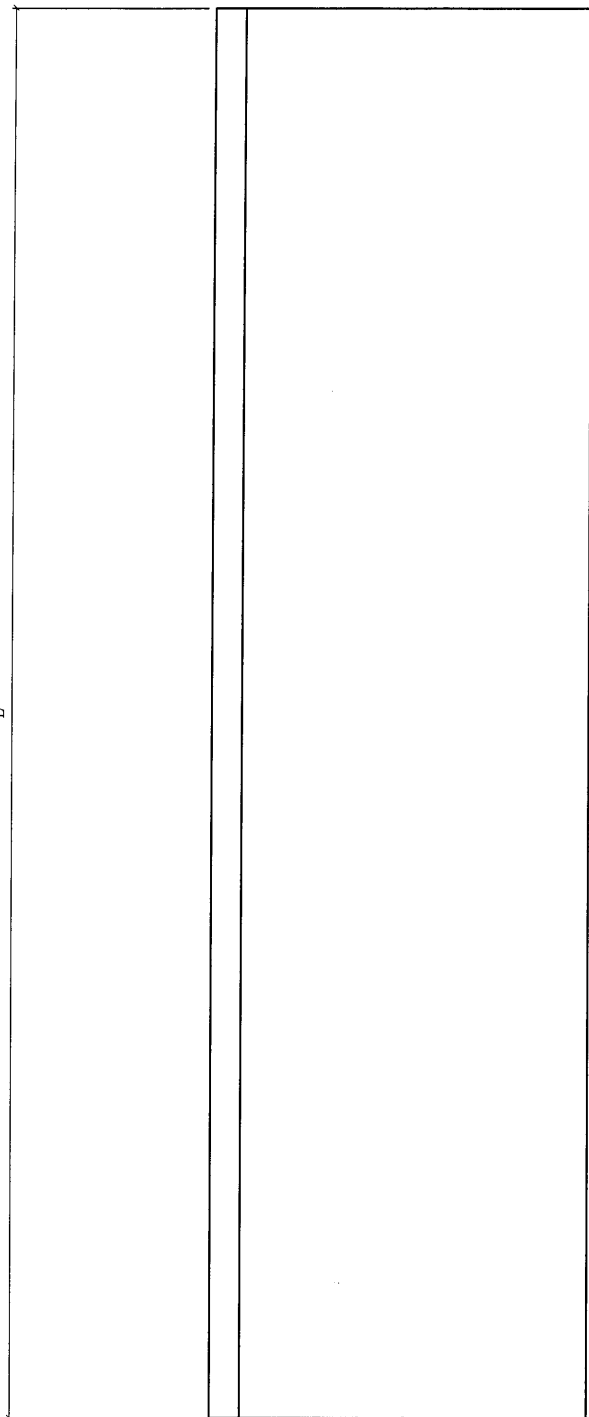

5

美特鋁質有限公司
MIDI Aluminium Fabricator Ltd.

工程號	J851	類別		物料號	-		
地盤	青衣190	制圖	W. E. X	2020-05-13	圖號	ST-AN03	
修改	-	採用工廠		地盤	✓	圖紙名稱	鐵件加工圖
日期	-	材料顏色	熱浸鋅	材料	75x50x6mm鐵角	復核	-
						批准	-
						數量	-
						單件重量	- (KG)

鐵件編號	L	N	數量	單件重量(kg)
ST-AN03-01	2000	2x800c/c	769	11.23
ST-AN03-02	1500	2x600c/c	201	8.38
ST-AN03-03	960	1x700c/c	968	5.36
ST-AN03-04	440	1x300c/c	853	2.46
ST-AN03-05	700	1x500c/c	38	4.25

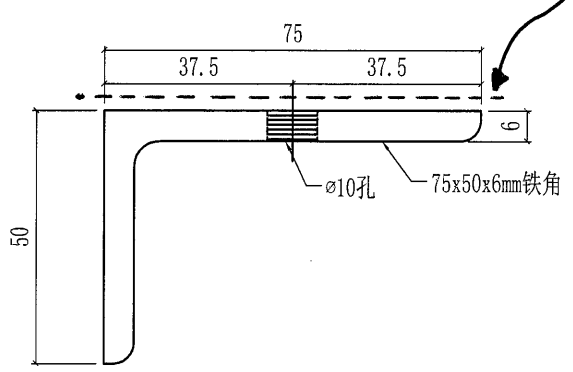
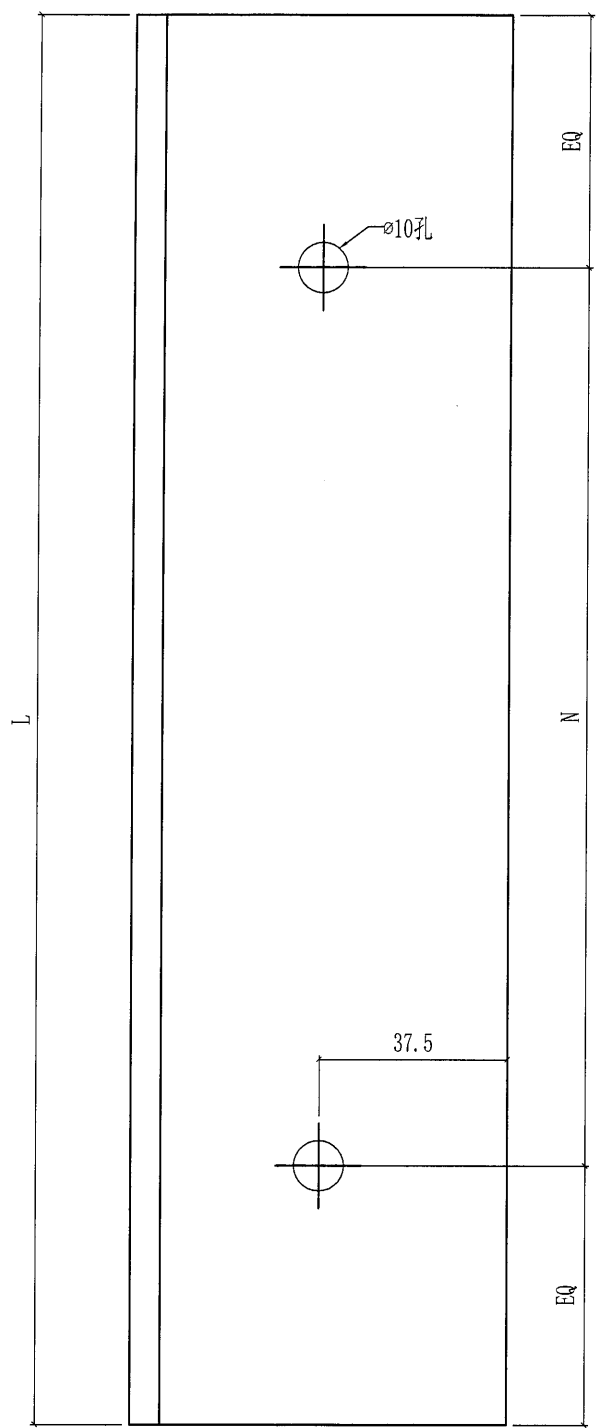

此面刷瀝青

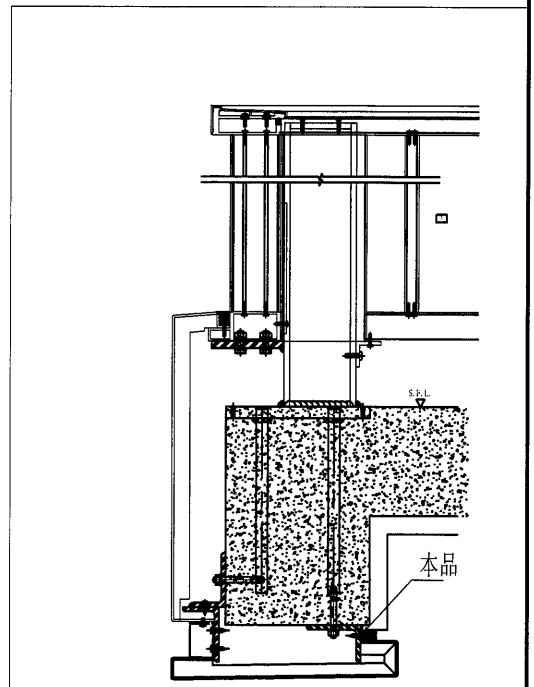

6

美特鋁質有限公司
MIDI Aluminium Fabricator Ltd.

工程號	J851	類別		物料號	-		
地盤	青衣190	制圖	W. E. X	2020-05-13	圖號	ST-AN04	
修改	-	採用工廠		地盤	✓	圖紙名稱	鐵件加工圖
日期	-	材料顏色	熱浸鋅	材料	100x50x5mm鐵槽	復核	-
						批准	-
						數量	-
						單件重量	- (KG)

鐵件編號	L	N	數量	單件重量(kg)
ST-AN04-01	200	1x100c/c	58	2.04
ST-AN04-02	360	1x200c/c	825	3.672
ST-AN04-03	660	1x500c/c	56	6.732

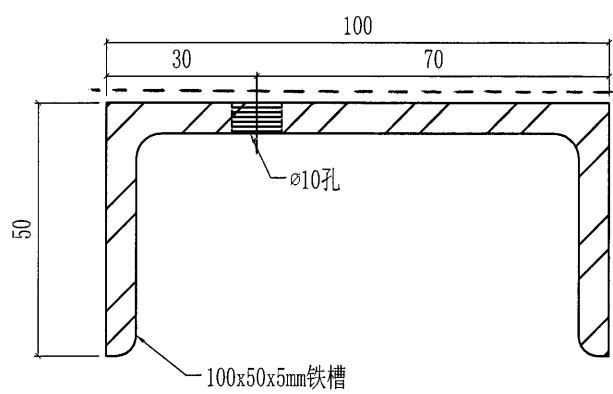
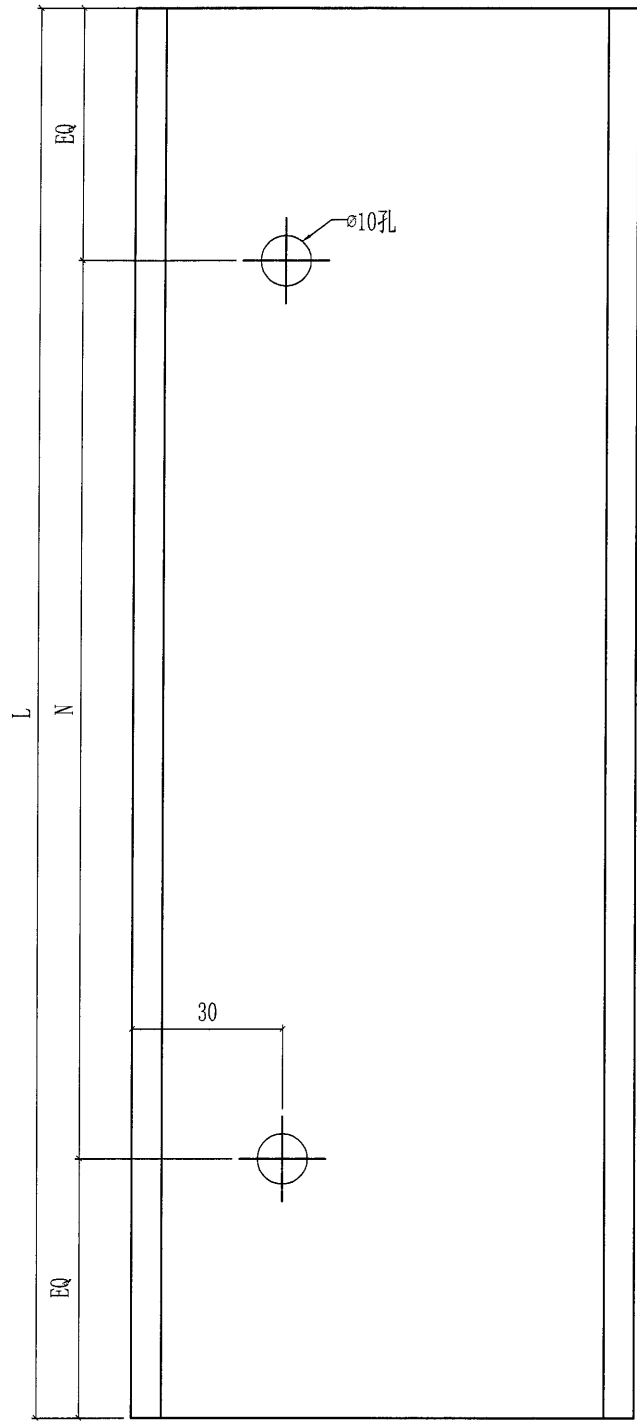

此面刷瀝青

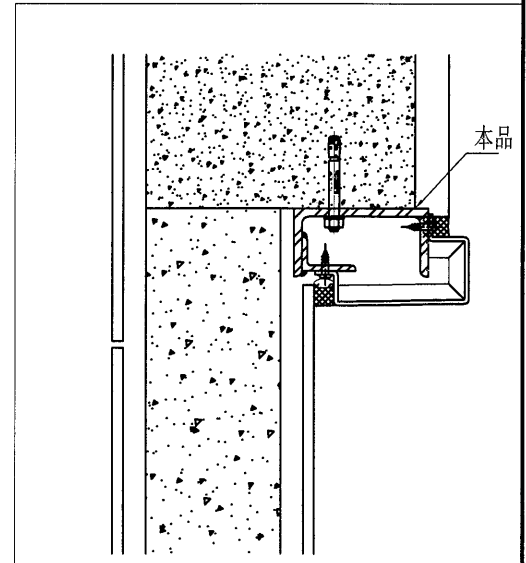

7

美特鋁質有限公司
MIDI Aluminium Fabricator Ltd.

工程號	J851	類別		物料號	-						
地盘	青衣190	制圖	W. E. X	2020-05-13	圖號	ST-AN05					
修改	-	採用工廠		地盤	✓	圖紙名稱	铁件加工图	復核	-	數量	-
日期	-	材料顏色	热浸锌	材料	40x25x4mm铁角	批准	-	單件重量	-	(KG)	

铁件编号	L	数量	单件重量(kg)
ST-AN05-01	200	58	0.38
ST-AN05-02	360	825	0.684
ST-AN05-03	660	56	1.254

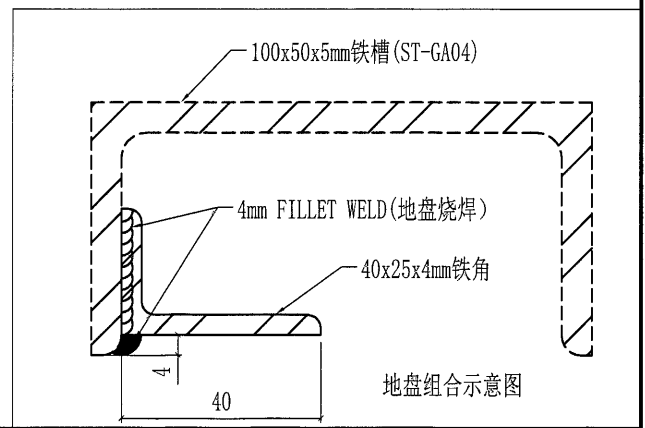
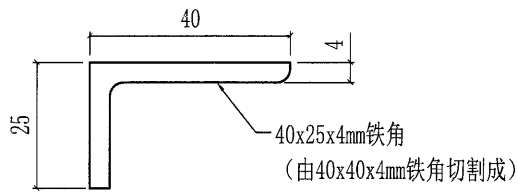
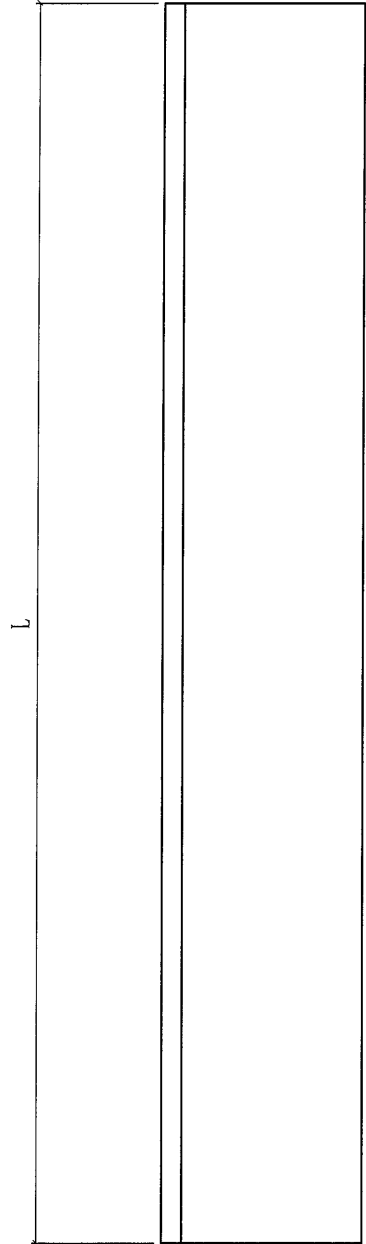

TI FLAT A

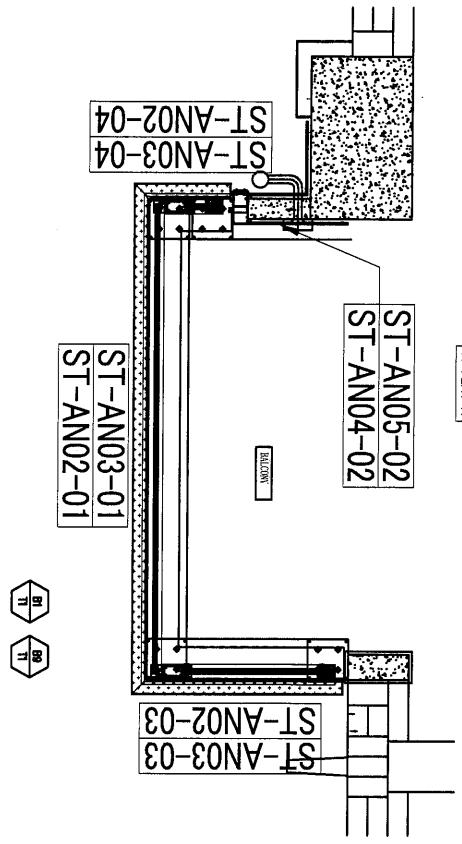

FAÇADE COLOUR

BALUSTRADE OF RAILING (1-17)	WHITE
BALUSTRADE OF RAILING (18-33)	DARK GREY
AL01	DARK GREY
AL02	WHITE
AL03	SANDY BROWN
AL04	TIMBER PATTERN

BAL TYPE TOWER FLR FLAT QTY

B1	T1	1/F	A	1
	T1	2/F TO 31/F	A	26
B9	T1	32/F	A	1
	T1	33/F	A	1



TI FLAT B

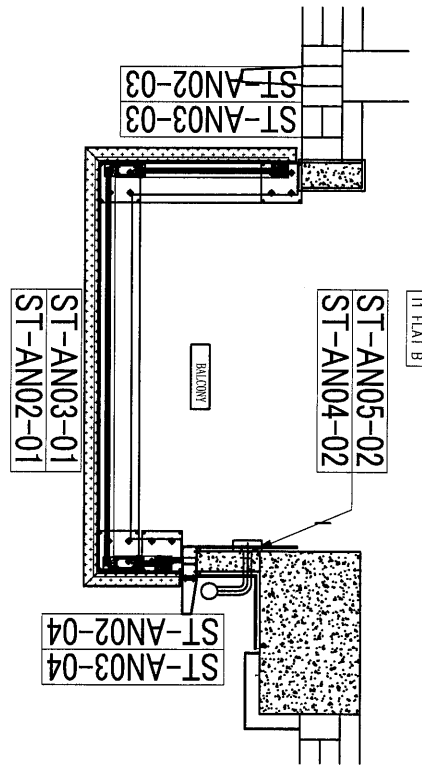

FAÇADE COLOUR

BALUSTRADE OF RAILING (1-17)	DARK GREY
BALUSTRADE OF RAILING (18-33)	WHITE
AL01	DARK GREY
AL02	WHITE
AL03	SANDY BROWN
AL04	TIMBER PATTERN

BAL TYPE TOWER FLR FLAT QTY

B2	T1	1/F	B	1
	T1	2/F TO 31/F	B	26
B10	T1	32/F	B	1



TI FLAT C

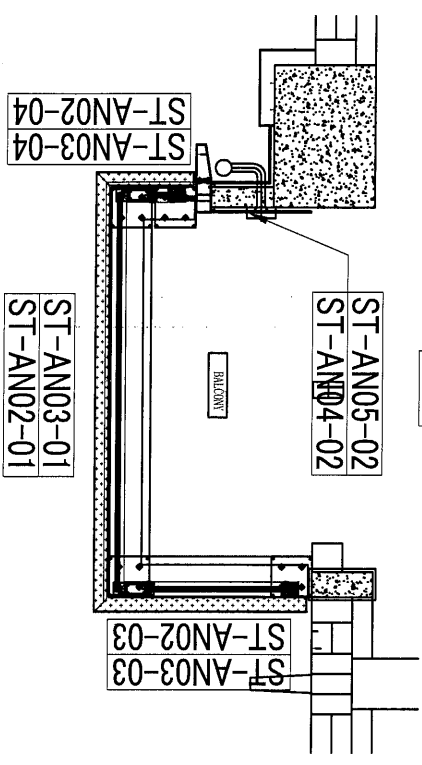

FAÇADE COLOUR

BALUSTRADE OF RAILING (1-17)	DARK GREY
BALUSTRADE OF RAILING (18-33)	WHITE
AL01	DARK GREY
AL02	WHITE
AL03	SANDY BROWN
AL04	TIMBER PATTERN

BAL TYPE TOWER FLR FLAT QTY

B2	T1	1/F	C	1
	T1	2/F TO 31/F	C	26
B10	T1	32/F	C	1
B10	T1	33/F	C	1



TI FLAT D

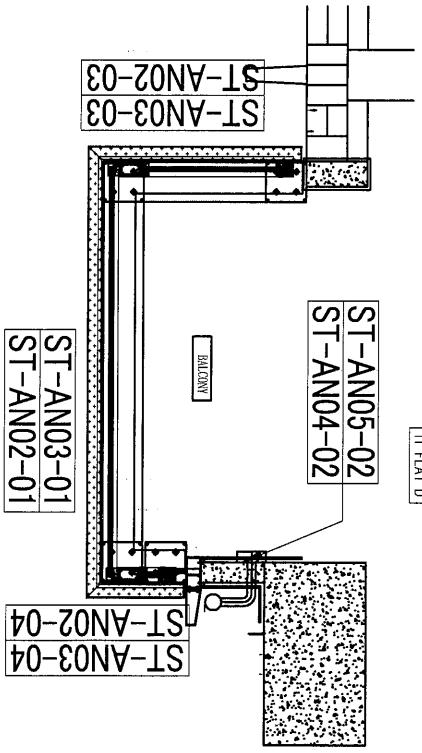

FAÇADE COLOUR

BALUSTRADE OF RAILING (1-17)	WHITE
BALUSTRADE OF RAILING (18-33)	DARK GREY
AL01	DARK GREY
AL02	WHITE
AL03	SANDY BROWN
AL04	TIMBER PATTERN

BAL TYPE TOWER FLR FLAT QTY

B3	T1	1/F	D	1
	T1	2/F TO 31/F	D	26
B11	T1	32/F	D	1



SCALE REF :
1:50
1:100
1:200
1:500
1:1000

GENERAL NOTES
1. All dimensions are in mm.
2. All elevations are viewed from outside.
3. All dimensions to be verified on site before construction.

Legend :
1. ST - Staircase
2. ST - Staircase
3. ST - Staircase
4. ST - Staircase

NO.	DATE	REVISION	BY

CLIENT : 佳明集團控股有限公司
GRAND MING GROUP HOLDINGS LIMITED

MAIN CONTRACTOR : GRAND TECH CONSTRUCTION CO. LTD.

ARCHITECT : 香港建築師學會
STRUCTURAL ENGINEER : 香港工程師學會

C M WONG & ASSOCIATES LTD

英特經貿有限公司
MIDI COMMERCIAL DEVELOPMENT LTD.

PROJECT : RESIDENTIAL DEVELOPMENT AT
TSING YI TOWN LOT 190 SAN SHAN ROAD

TITLE :
TITLE-1
TITLE-2
TITLE-3
TITLE-4

JOB NO. :	1-581	DATE :	
DRAWN BY :		SCALE :	
CHECK BY :		DATE :	
DRAWN NO. :		REV. :	

(9)

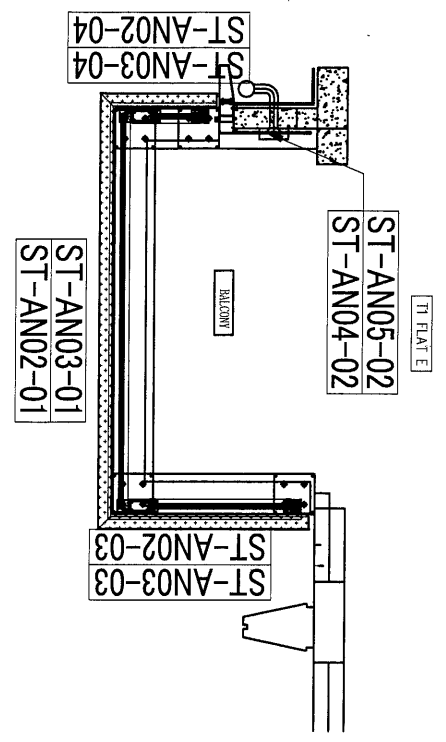

FAÇADE COLOUR

BALUSTRADE OF RAILING (2~17F)	DARK GREY
BALUSTRADE OF RAILING (18~33F)	DARK GREY
AL01	DARK GREY
AL02	WHITE
AL03	SANDY BROWN
AL04	TIMBER PATTERN

BAL TYPE	TOWER	FLR	FLAT	QTY
B4	TI	2/F TO 31/F	E	28
B12	TI	32/F TO 33/F	E	2

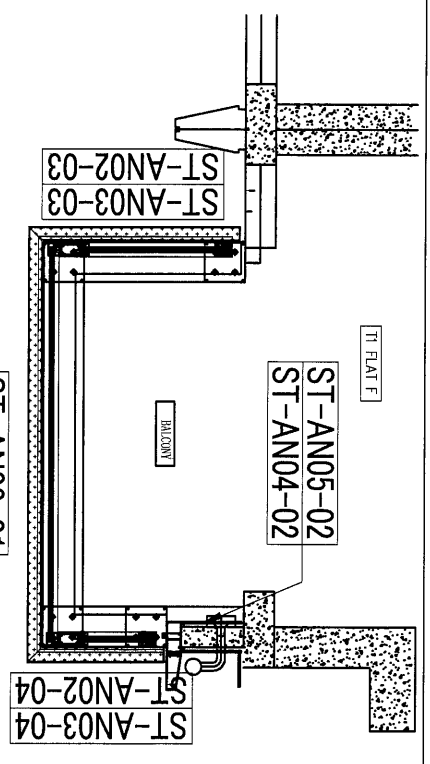

FAÇADE COLOUR

BALUSTRADE OF RAILING (2~17F)	DARK GREY
BALUSTRADE OF RAILING (18~33F)	DARK GREY
AL01	DARK GREY
AL02	WHITE
AL03	SANDY BROWN
AL04	TIMBER PATTERN

BAL TYPE	TOWER	FLR	FLAT	QTY
B5	TI	2/F TO 31/F	F	28
B13	TI	32/F TO 33/F	F	2

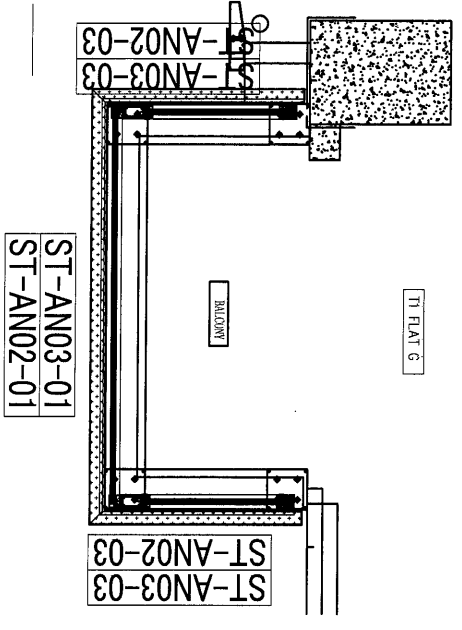

FAÇADE COLOUR

BALUSTRADE OF RAILING (2~17F)	DARK GREY
BALUSTRADE OF RAILING (18~33F)	DARK GREY
AL01	DARK GREY
AL02	WHITE
AL03	SANDY BROWN
AL04	TIMBER PATTERN

BAL TYPE	TOWER	FLR	FLAT	QTY
B6	TI	2/F TO 31/F	G	28
B14	TI	32/F TO 33/F	G	2

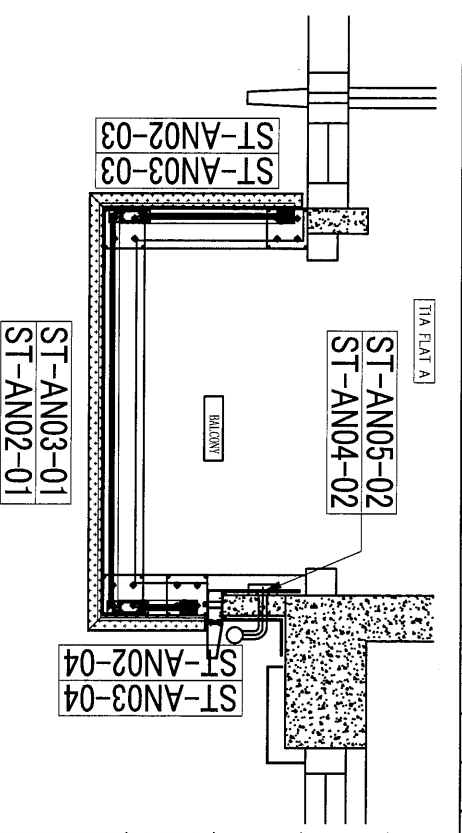

FAÇADE COLOUR

BALUSTRADE OF RAILING (2~17F)	DARK GREY
BALUSTRADE OF RAILING (18~33F)	DARK GREY
AL01	DARK GREY
AL02	WHITE
AL03	SANDY BROWN
AL04	TIMBER PATTERN

BAL TYPE	TOWER	FLR	FLAT	QTY
B7	T1A	2/F TO 31/F	A	28
B15	T1A	32/F TO 33/F	A	2



SCALE REF :
 FSU REF :
 Note :
 1. All dimensions are in mm.
 2. All elevations are viewed from outside.
 3. All dimensions to be verified on site before construction.
 GENERAL NOTES

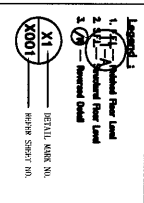

CLIENT : 住明集團控股有限公司
 GRAND MING GROUP HOLDINGS LIMITED

MAIN CONTRACTOR : GRAND TECH CONSTRUCTION CO. LTD.

ARCHITECT : WONG YONG & PARTNERS LIMITED

STRUCTURAL ENGINEER : C M WONG & ASSOCIATES LTD

M&E ENGINEER : 英特經實有限公司
 MIDT COMMERCIAL ENGINEERING LTD.
 110 Selegie Road, Singapore, 117
 Tel: 65486111 Fax: 65477788

PROJECT : RESIDENTIAL DEVELOPMENT AT TSIANG YI TOWN LOT 180 SAI SHAN ROAD

TITLE :
 TITLE-1
 TITLE-2
 TITLE-3
 TITLE-4

JOB NO. : J-851
 DRAWN BY : CHENWJ
 DATE :
 CHECK BY :
 SCALE : AS SH
 DATE :
 DRAWING NO. :
 REVISION :

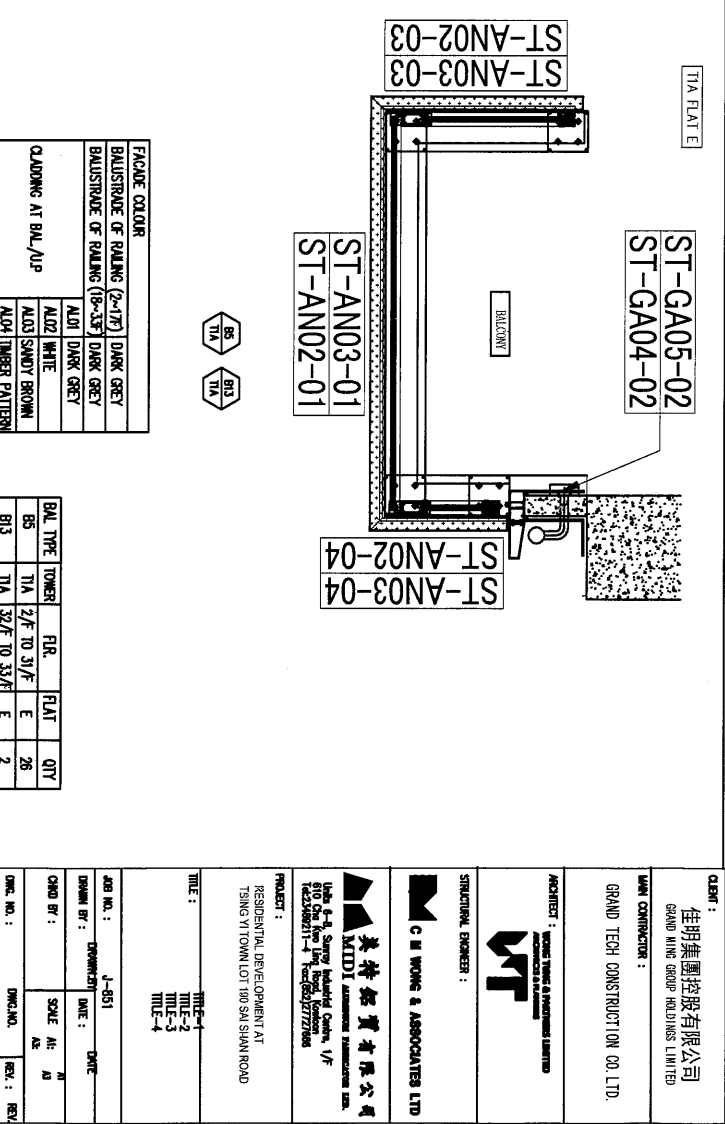
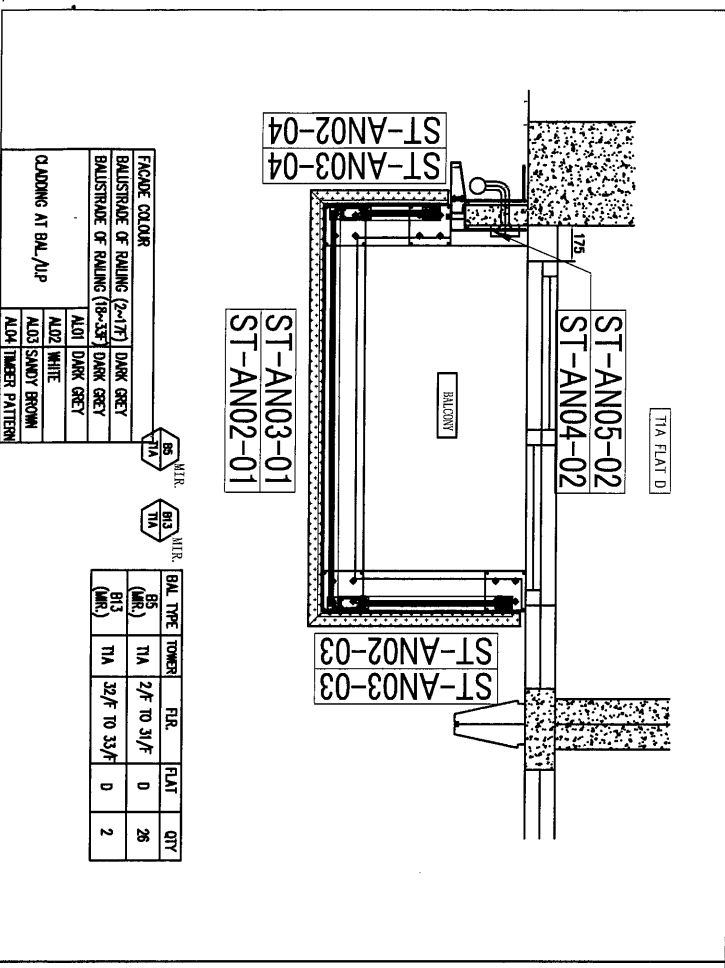
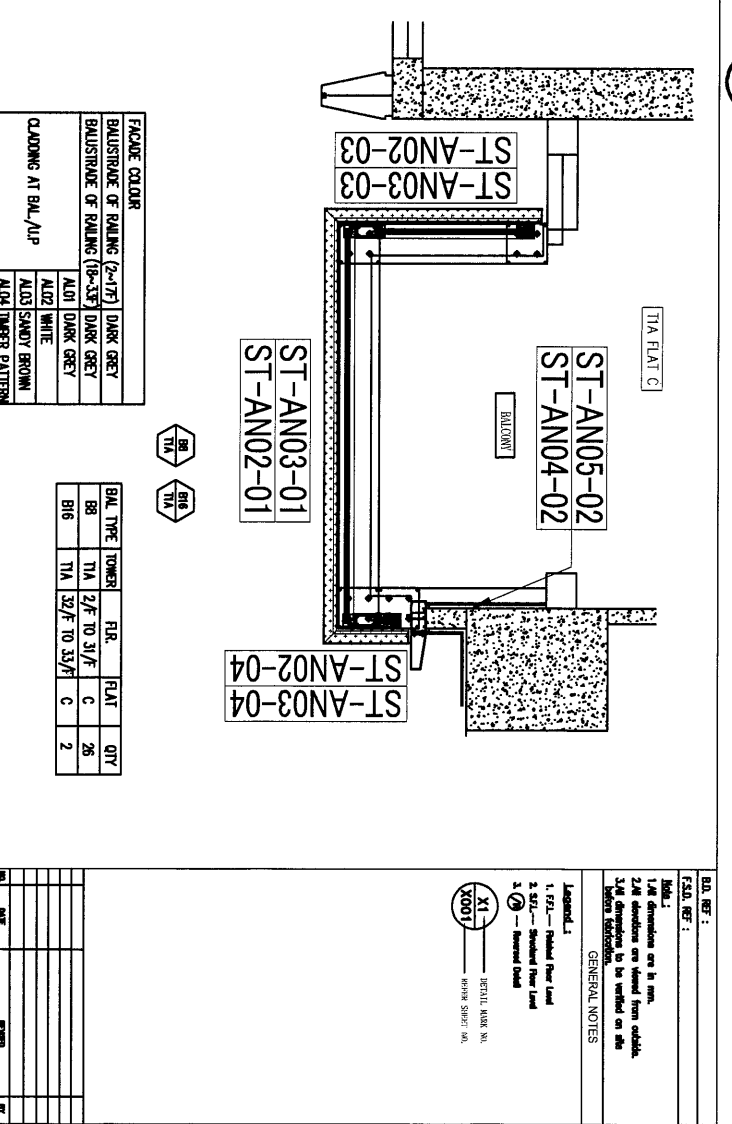
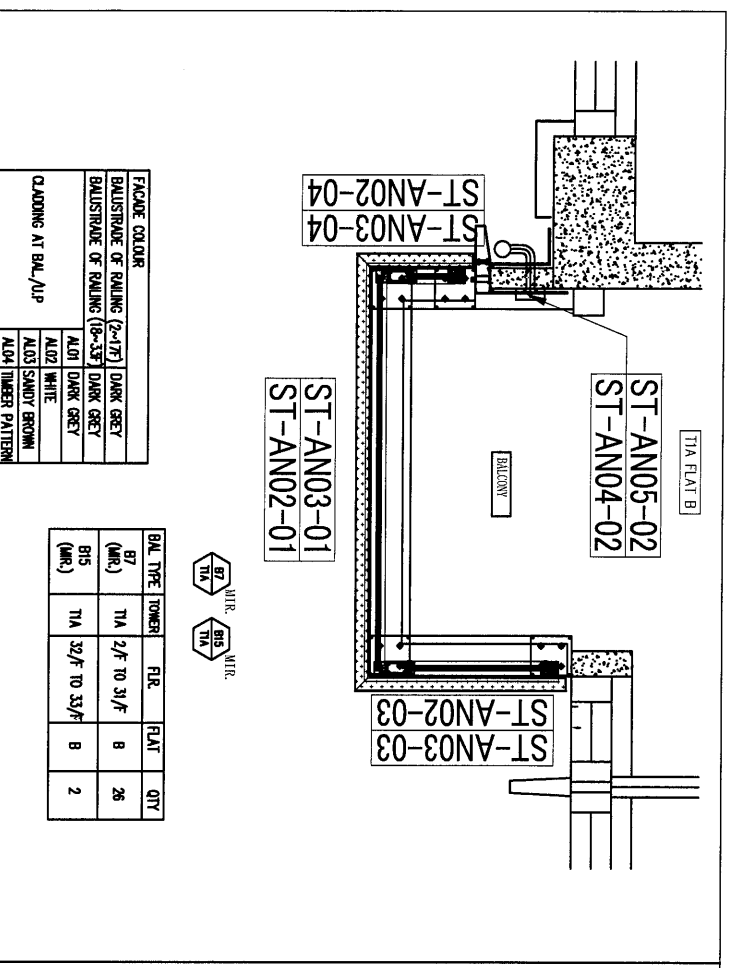

DATE: 11/11/2014
 F.S.O. REF: 11/11/2014
 Note: 1. All dimensions are in mm.
 2. All elevations are viewed from outside.
 3. All dimensions to be verified on site before construction.

Legend:
 1. F51 - Panel Floor Lead
 2. F52 - Standard Floor Lead
 3. F53 - Internal Lead
 4. F54 - External Lead

CLIENT: 佳明集團控股有限公司
 GRAND MING GROUP HOLDINGS LIMITED
 MAIN CONTRACTOR: GRAND TECH CONSTRUCTION CO. LTD.
 ARCHITECT: WONG TUNG & PARTNERS LIMITED
 STRUCTURAL ENGINEER: C M WONG & ASSOCIATES LTD
 11th Floor, Spring Industrial Centre, 1/F
 610 Cheong Cheong Street, Tsim Sha Tsui
 Tel: (852) 27772000 Fax: (852) 27772000

PROJECT: RESIDENTIAL DEVELOPMENT AT TSIANG VI TOWN LOT 110 SAN SHAN ROAD
 TITLE: TITLE-1
 TITLE-2
 TITLE-3
 TITLE-4
 JOB NO.: 1-051
 DRAWN BY: DWG
 DATE: 11/11/2014
 CHECK BY: SCALE: A1
 DATE: 11/11/2014
 DWG. NO.: REV: REV

11

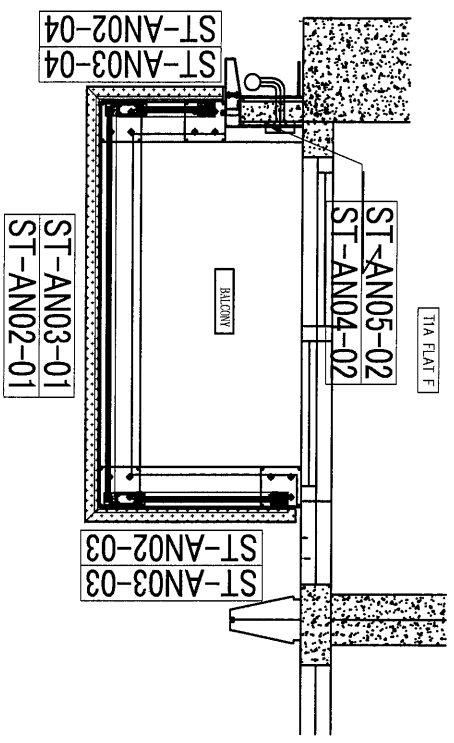

FAÇADE COLOUR

BALUSTRADE OF RAILING (2-1/7)	DARK GREY
BALUSTRADE OF RAILING (8-13)	DARK GREY
AL01	DARK GREY
AL02	WHITE
AL03	SANDY BROWN
AL04	TIMBER PATTERN

BAL. TYPE TOWER FLR. FLAT QTY

B5 (MR.)	T1A	2/F TO 31/F	F	26
B13 (MR.)	T1A	32/F TO 33/F	F	2

T12 FLAT A (MIR.)

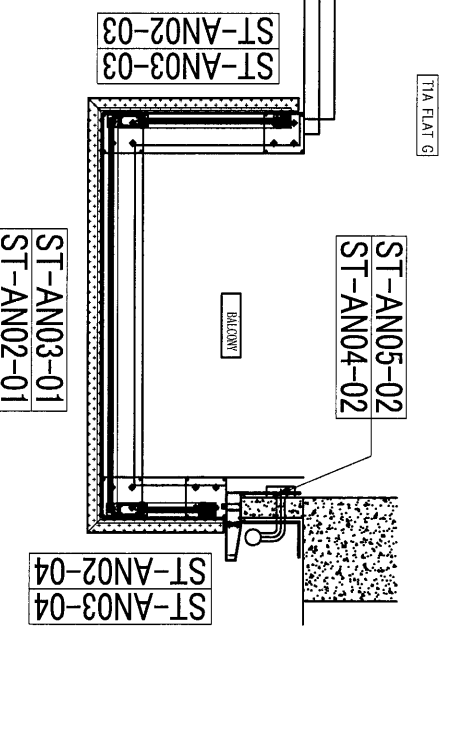

FAÇADE COLOUR

BALUSTRADE OF RAILING (2-1/7)	DARK GREY
BALUSTRADE OF RAILING (8-13)	DARK GREY
AL01	DARK GREY
AL02	WHITE
AL03	SANDY BROWN
AL04	TIMBER PATTERN

BAL. TYPE TOWER FLR. FLAT QTY

B5 (MR.)	T1A	2/F TO 31/F	F	26
B13 (MR.)	T1A	32/F TO 33/F	F	2

T12 FLAT B

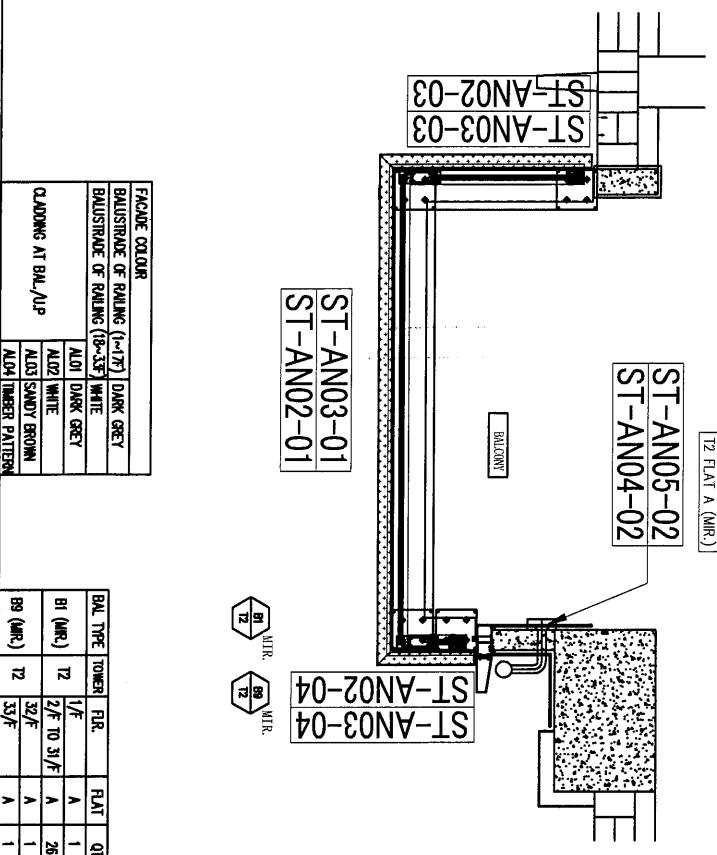

FAÇADE COLOUR

BALUSTRADE OF RAILING (2-1/7)	DARK GREY
BALUSTRADE OF RAILING (8-13)	WHITE
AL01	DARK GREY
AL02	WHITE
AL03	SANDY BROWN
AL04	TIMBER PATTERN

BAL. TYPE TOWER FLR. FLAT QTY

B1 (MR.)	T2	1/F	A	1
B12 (MR.)	T2	2/F TO 31/F	A	26
B9 (MR.)	T2	32/F	A	1
		33/F	A	1

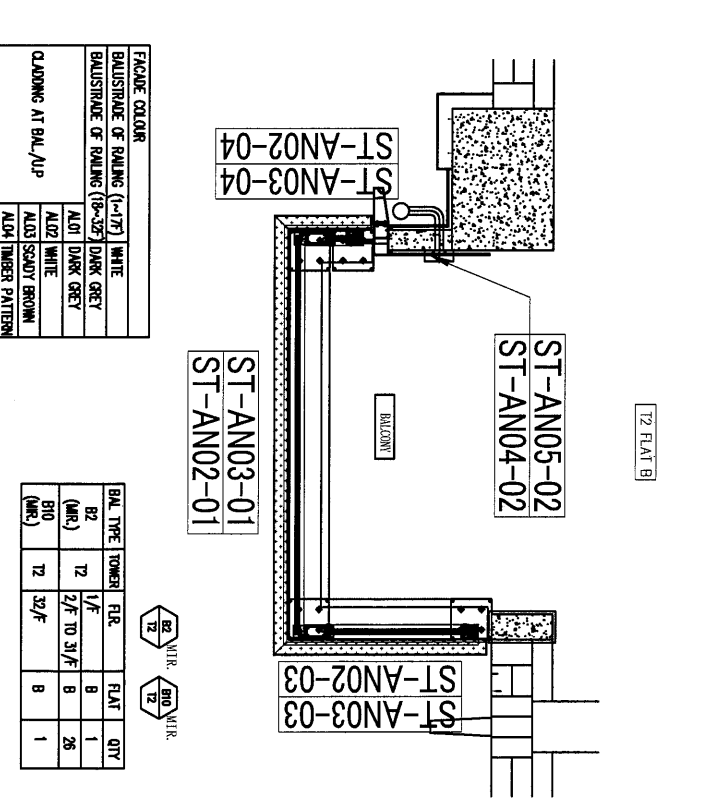

FAÇADE COLOUR

BALUSTRADE OF RAILING (2-1/7)	WHITE
BALUSTRADE OF RAILING (8-13)	DARK GREY
AL01	DARK GREY
AL02	WHITE
AL03	SANDY BROWN
AL04	TIMBER PATTERN

BAL. TYPE TOWER FLR. FLAT QTY

B2 (MR.)	T2	1/F	B	1
B10 (MR.)	T2	2/F TO 31/F	B	26
		32/F	B	1
		33/F	B	1

DDI REF :
 FSOI REF :
 Note :
 1. All dimensions are in mm.
 2. All dimensions are stated from outside.
 3. All dimensions to be verified on site.
 4. All dimensions to be verified on site.
 GENERAL NOTES

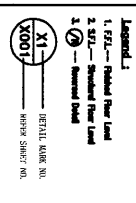

美特經實有限公司
 MIDT ASSOCIATED CONSULTANTS
 11th-14th Storey, Island Centre, 1/F
 810 The Loop, Hong Kong, China
 Tel: 2522 1111 Fax: 2522 1111

PROJECT - 1
 RESIDENTIAL DEVELOPMENT AT
 TSIING YI TOWER 300 SAI SHAN ROAD
 PROJECT - 4

TITLE :
 TITLE - 1
 TITLE - 2
 TITLE - 3
 TITLE - 4

JOB NO. :	DATE :
DRAWN BY :	DATE :
CHECKED BY :	DATE :
CHECKER :	DATE :
CHK. NO. :	REV. :

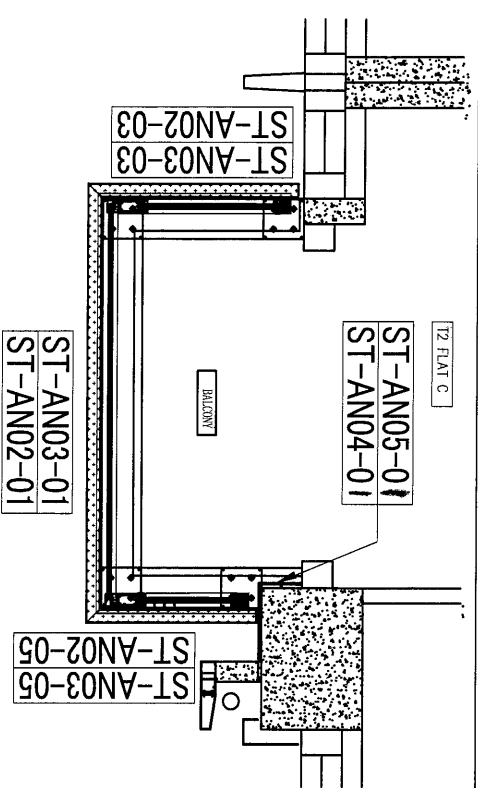

FAÇADE COLOUR

BALUSTRADE OF RAILING (1~17F)	WHITE
BALUSTRADE OF RAILING (18~32F)	DARK GREY
AL01	DARK GREY
AL02	WHITE
AL03	SANDY BROWN
AL04	TIMBER PATTERN

CLADDING AT BAL./L/P

BAL. TYPE	TOWER	R/R	FLAT	QTY
B17	T2	1/F	C	1
B22	T2	2/F TO 31/F	C	26
B22	T2	32/F	C	1

BAL. TYPE TOWER R/R FLAT QTY

B17	T2	1/F	C	1
B22	T2	2/F TO 31/F	C	26
B22	T2	32/F	C	1

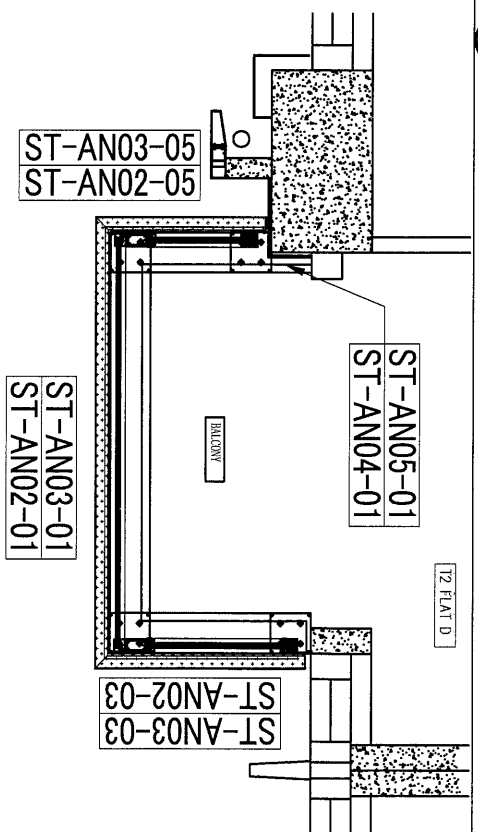

FAÇADE COLOUR

BALUSTRADE OF RAILING (1~17F)	DARK GREY
BALUSTRADE OF RAILING (18~32F)	WHITE
AL01	DARK GREY
AL02	WHITE
AL03	SANDY BROWN
AL04	TIMBER PATTERN

CLADDING AT BAL./L/P

BAL. TYPE	TOWER	R/R	FLAT	QTY
B18	T2	1/F	D	1
B23	T2	2/F TO 31/F	D	26
B23	T2	32/F	D	1

BAL. TYPE TOWER R/R FLAT QTY

B18	T2	1/F	D	1
B23	T2	2/F TO 31/F	D	26
B23	T2	32/F	D	1

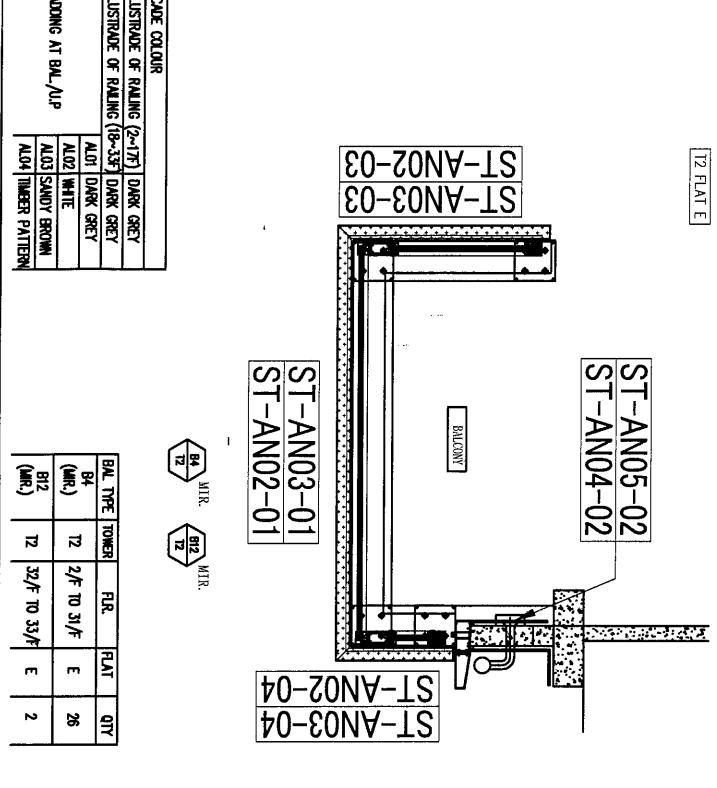

FAÇADE COLOUR

BALUSTRADE OF RAILING (2~17F)	DARK GREY
BALUSTRADE OF RAILING (18~32F)	DARK GREY
AL01	DARK GREY
AL02	WHITE
AL03	SANDY BROWN
AL04	TIMBER PATTERN

CLADDING AT BAL./L/P

BAL. TYPE	TOWER	R/R	FLAT	QTY
B4	T2	2/F TO 31/F	E	26
B12	T2	32/F TO 33/F	E	2

BAL. TYPE TOWER R/R FLAT QTY

B4	T2	2/F TO 31/F	E	26
B12	T2	32/F TO 33/F	E	2

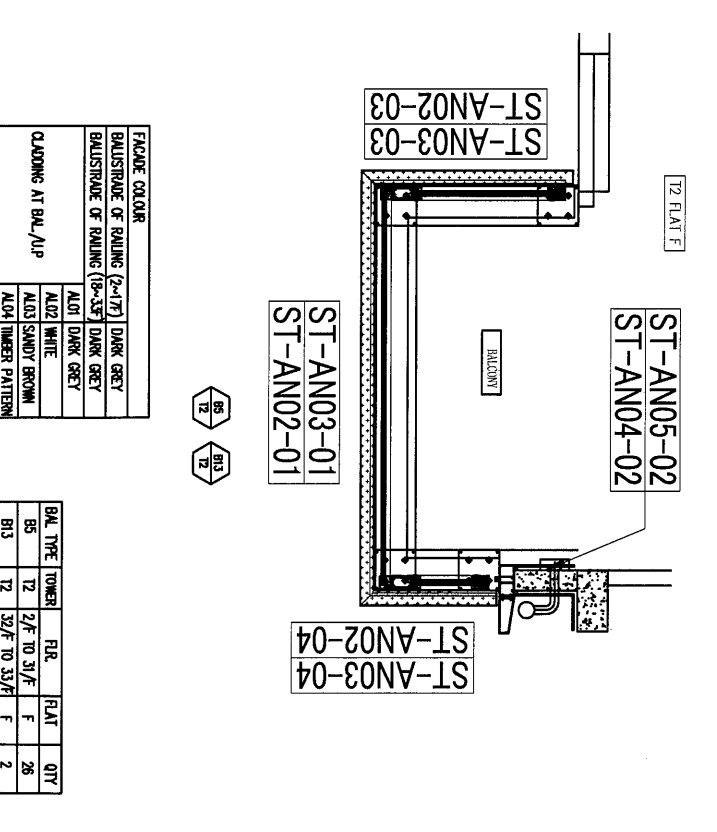

FAÇADE COLOUR

BALUSTRADE OF RAILING (2~17F)	DARK GREY
BALUSTRADE OF RAILING (18~32F)	DARK GREY
AL01	DARK GREY
AL02	WHITE
AL03	SANDY BROWN
AL04	TIMBER PATTERN

CLADDING AT BAL./L/P

BAL. TYPE	TOWER	R/R	FLAT	QTY
B5	T2	2/F TO 31/F	F	26
B13	T2	32/F TO 33/F	F	2

BAL. TYPE TOWER R/R FLAT QTY

B5	T2	2/F TO 31/F	F	26
B13	T2	32/F TO 33/F	F	2

SCALE: 1/50

DATE: 2023.07.26

PROJECT: RESIDENTIAL DEVELOPMENT AT TSIANG YI TOWN LOT 170/5A, SHAN ROAD

CLIENT: 佳明集團控股有限公司
GRAND WING GROUP HOLDINGS LIMITED

MAIN CONTRACTOR: GRAND TECH CONSTRUCTION CO. LTD.

STRUCTURAL ENGINEER: C M WONG & ASSOCIATES LTD

ARCHITECT: 英特建築有限公司
MIDI ASSOCIATES ARCHITECTURE LTD.

GENERAL NOTES

1. ERI - External Floor Level
2. ERI - Standard Floor Level
3. ERI - Internal Floor Level

Legend:

- X1 - Detail Room No.
- X001 - Mirror Sheet No.

JOB NO.: J-051

DRAWN BY: CHENWEN

DATE: 2023.07.26

SCALE: A1

DWG. NO.: 12

REV.: 001

(13)

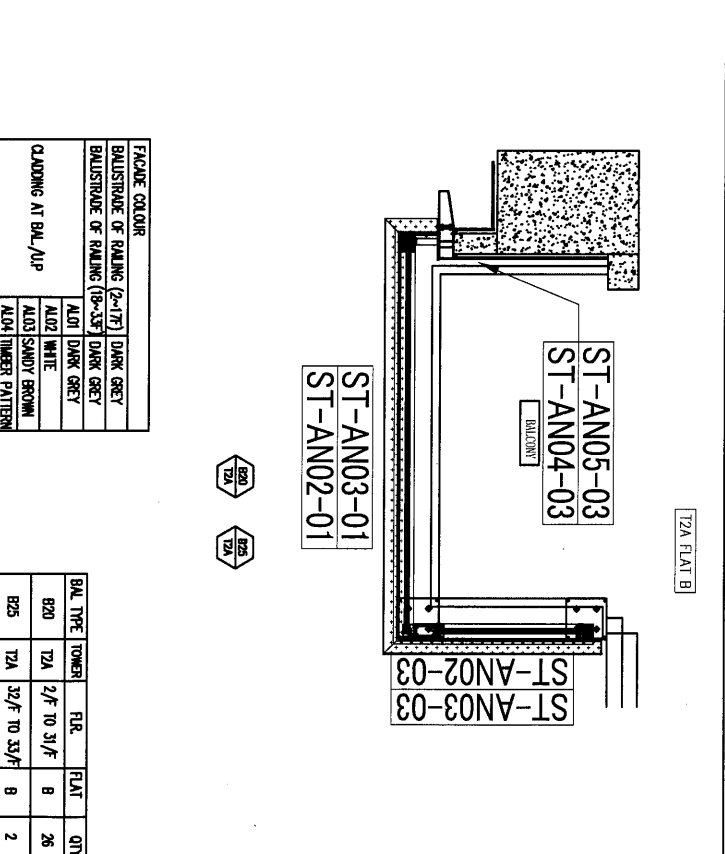
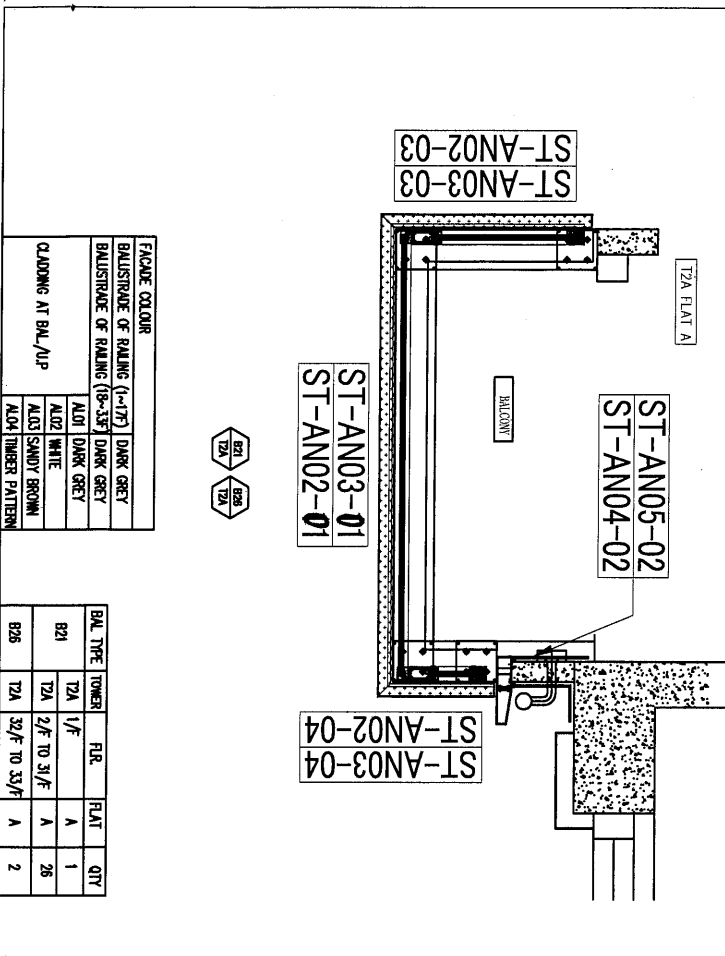
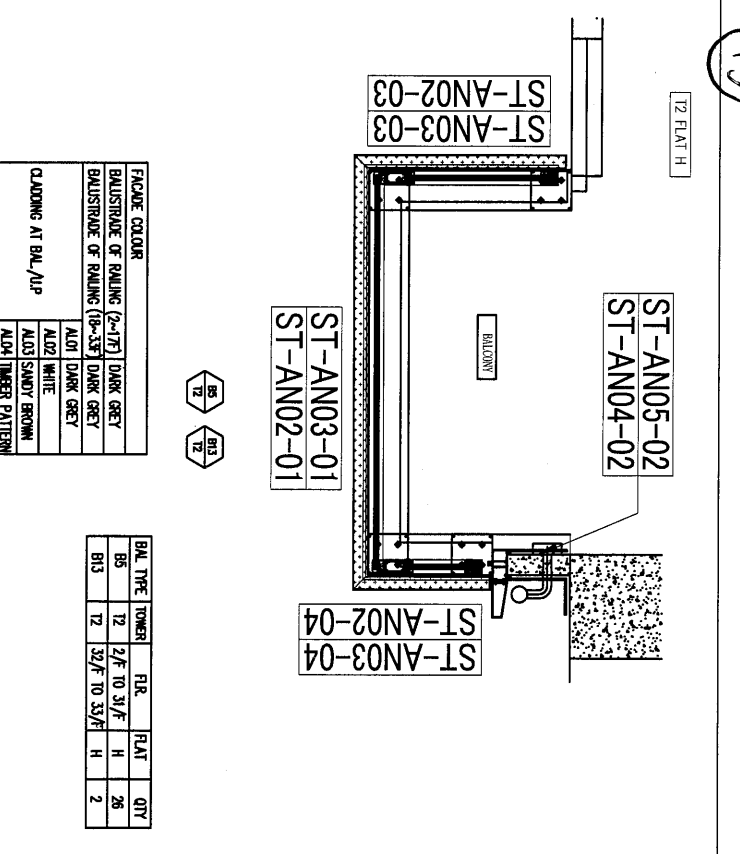
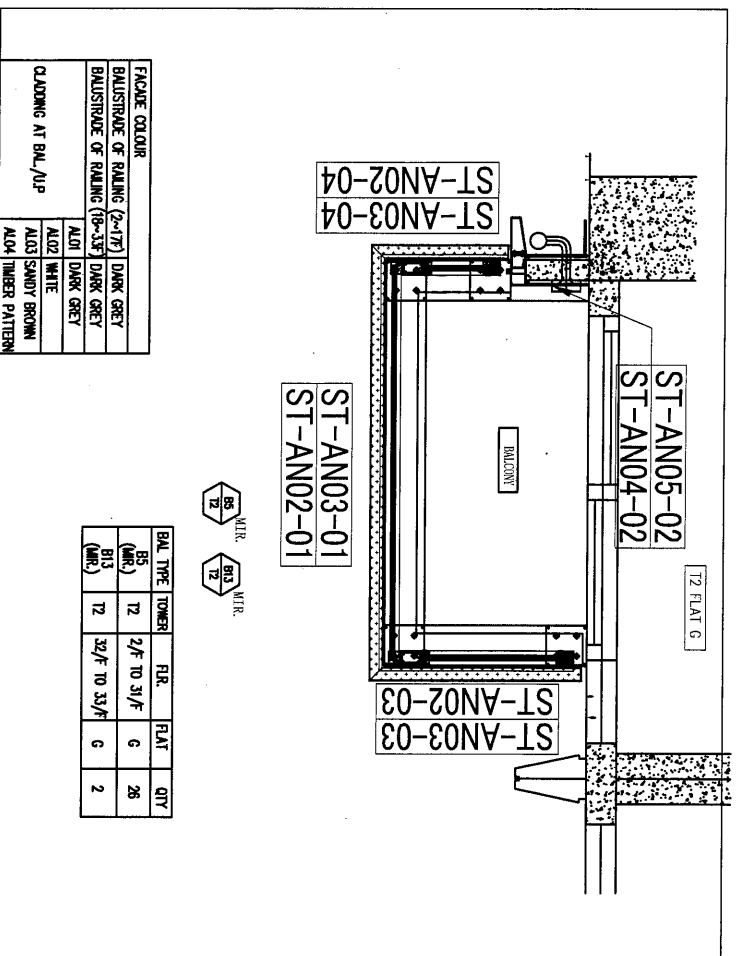

DATE: / /
 TITLE: / /
 SHEET NO. /

Legend:
 1. F21 - Painted Iron Lead
 2. F22 - Standard Iron Lead
 3. F23 - Mineral Lead
 4. F24 - Mineral Lead

CLIENT: 佳明集團控股有限公司
 GRAND WING GROUP HOLDINGS LIMITED
 MAIN CONTRACTOR: GRAND TECH CONSTRUCTION CO. LTD.
 ARCHITECT: WONG YONG & ASSOCIATES LIMITED
 STRUCTURAL ENGINEER: C M WONG & ASSOCIATES LTD
 PROJECT: Residential Development at Tsinng Yi Town Lot 190 SA Shau Road

DATE: / /
 TITLE: / /
 SHEET NO. /

JOB NO.: 1-831
 DRAWN BY: DATE: / /
 CHECK BY: SCALE: A1: M
 DATE: / /
 DWG. NO.: DWG. NO.: REV.: REV:

15

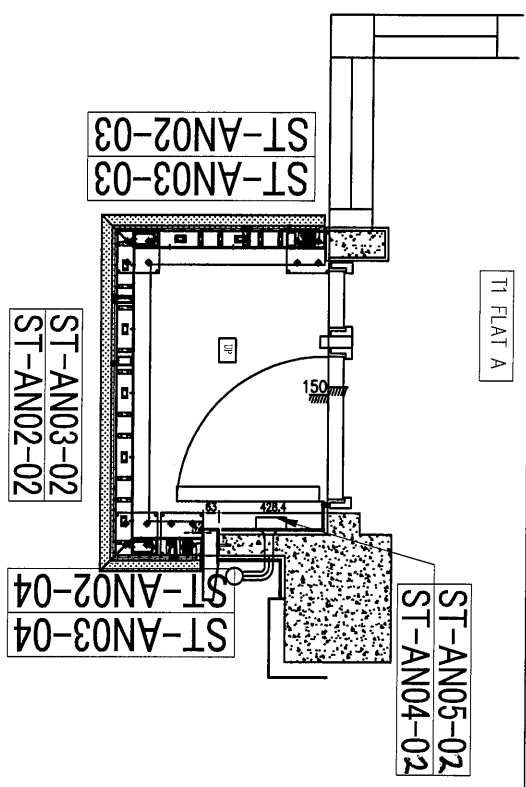

14W
15G

UP TYPE	TOWER	F/R	FLAT	QTY
UP1	T1	1/F TO 31/F	A	27
(FLOOR NOS. 4, 13, 14, 24 NOT USED)				
UP4	T1	32/F TO 33/F	A	2

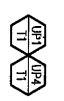

T2A FLAT B

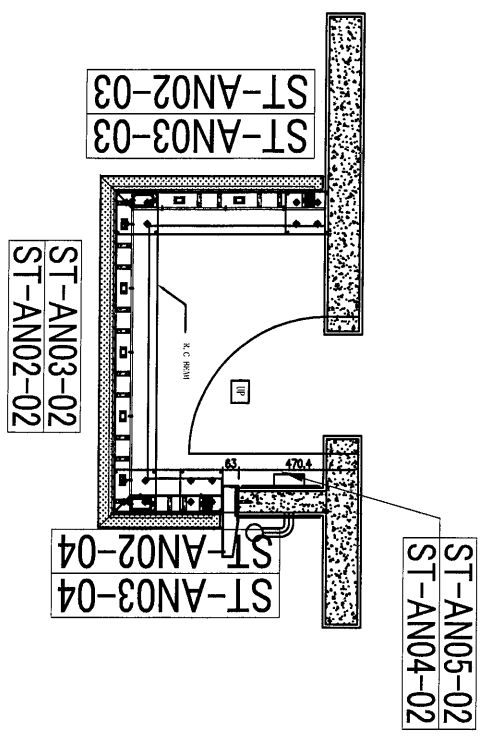

28C

UP TYPE	TOWER	F/R	FLAT	QTY
UP3 (U12)	T2A	12/F TO 31/F	B	26
(FLOOR NOS. 4, 13, 14, 24 NOT USED)				
UP6 (U12)	T2A	32/F TO 33/F	B	2

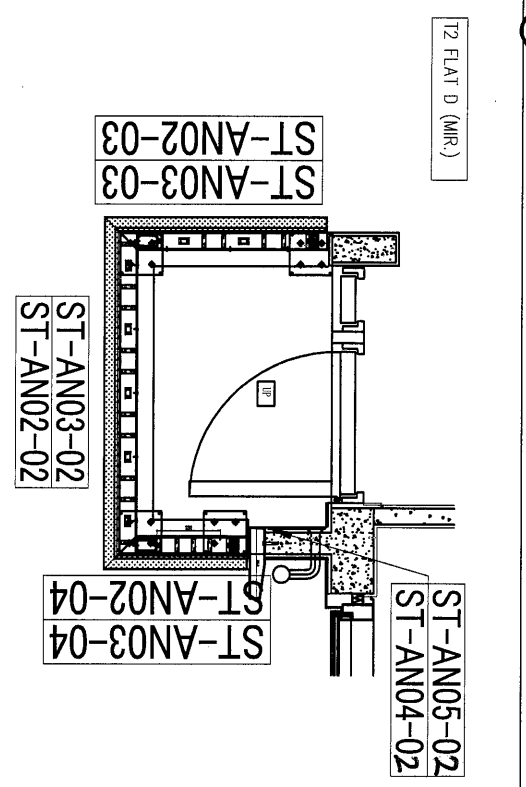

14G
15W

UP TYPE	TOWER	F/R	FLAT	QTY
UP2 (U12)	T2	1/F TO 31/F	D	27
(FLOOR NOS. 4, 13, 14, 24 NOT USED)				
UP5 (U12)	T2	32/F TO 33/F	D	2



T2A FLAT A

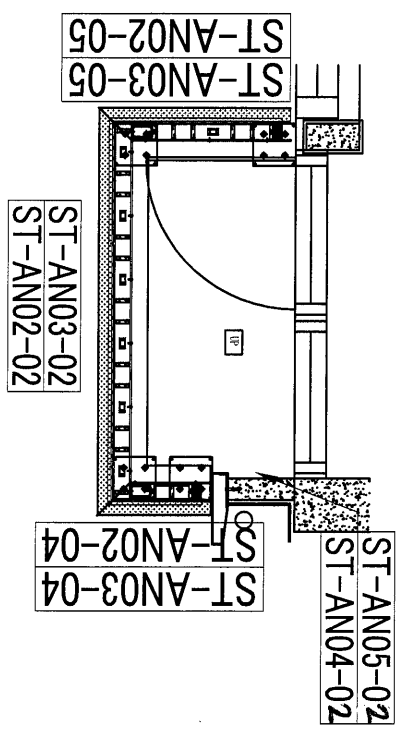

29C

UP TYPE	TOWER	F/R	FLAT	QTY
UP8	T2A	1/F TO 31/F	A	27
(FLOOR NOS. 4, 13, 14, 24 NOT USED)				
UP9	T2A	32/F TO 33/F	A	2



DATE: REF: F333 REF: 1. All dimensions are in mm. 2. All dimensions are stated from outside. 3. All dimensions to be verified on site before construction.

GENERAL NOTES

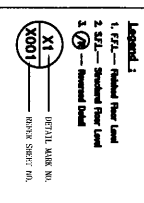

CLIENT: 佳明集團控股有限公司
GRAND MINE GROUP HOLDINGS LIMITED

MAIN CONTRACTOR: GRAND TECH CONSTRUCTION CO. LTD.

ARCHITECT: 香港建築師學會
C M WONG & ASSOCIATES LTD
MCDI ASSOCIATES INTERNATIONAL S.A.

PROJECT: RESIDENTIAL DEVELOPMENT AT TSING YI TOWN LOT 100 SAN SHAN ROAD

DATE: 1-8-01
DRAWN BY: NAME: DATE: SCALE: A1: A1
CHKD BY: NAME: DATE: SCALE: A1: A1
ENCL. NO.: REV: REV:

16

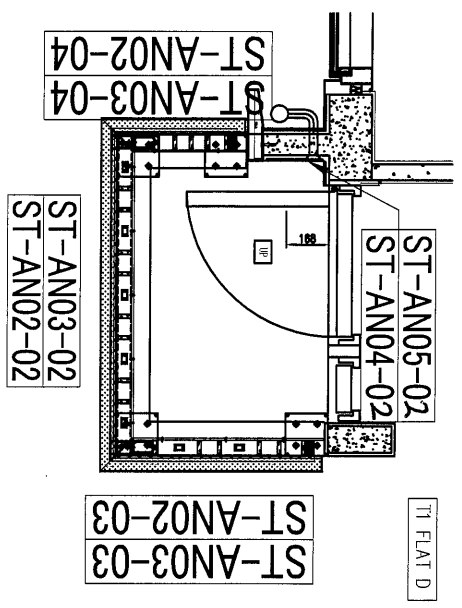

14W
15G

UP TYPE	TOWER	FLOOR	FLAT	QTY
UP2	T1	1/F TO 31/F	D	27
(FLOOR NOS. 4, 13, 14, 24 NOT USED)				
UP5	T1	32/F TO 33/F	D	2

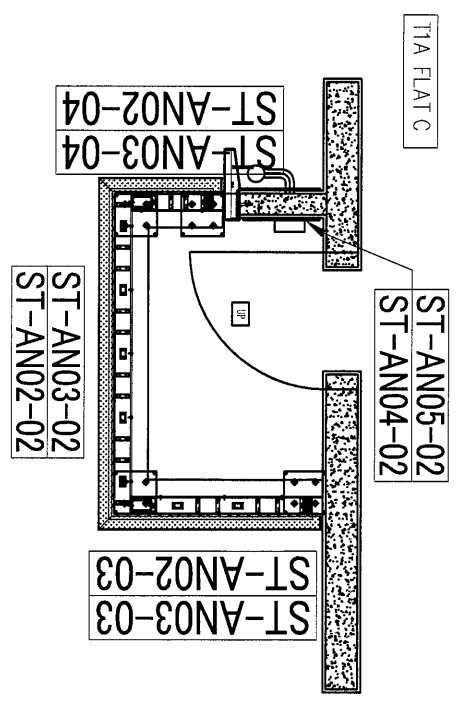

UP TYPE	TOWER	FLOOR	FLAT	QTY
UP3	T1A	2/F TO 31/F	C	26
(FLOOR NOS. 4, 13, 14, 24 NOT USED)				
UP6	T1A	32/F TO 33/F	C	2



28G

T2 FLAT A (MIR.)

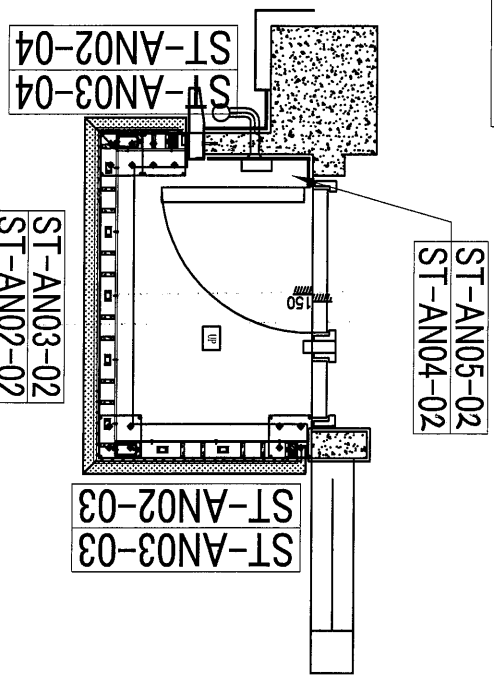

UP TYPE	TOWER	FLOOR	FLAT	QTY
UP1	T2	1/F TO 31/F	A	27
(FLOOR NOS. 4, 13, 14, 24 NOT USED)				
UP4	T2	32/F TO 33/F	A	2

14G
15W



T1A FLAT A

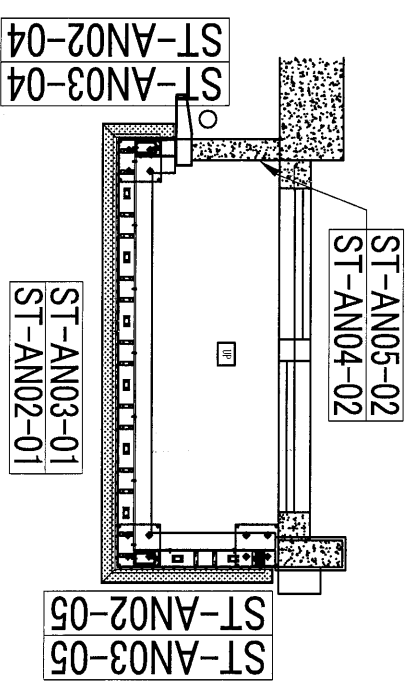

UP TYPE	TOWER	FLOOR	FLAT	QTY
UP7	T1A	33/F	A	1

1G



DATE: 11/11/2020
 ESD: 11/11/2020
 Scale: 1:50
 1. All dimensions are in mm.
 2. All dimensions are based from outside.
 3. All dimensions to be verified on site before construction.
 GENERAL NOTES

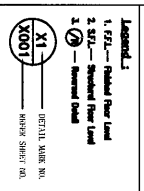

CLIENT: 生明集團控股有限公司
 GRAND MING GROUP HOLDINGS LIMITED
 MAIN CONTRACTOR: GRAND TECH CONSTRUCTION CO. LTD.
 ARCHITECT: 香港建築師學會
 STRUCTURAL ENGINEER: C M WONG & ASSOCIATES LTD
 11th & 12th Storey, 100, Des Voeux Road, Central, Hong Kong
 Tel: (852) 2211-1111 Fax: (852) 2211-1111
 PROJECT: RESIDENTIAL DEVELOPMENT AT TSIING YI TOWN LOT 180, SHAH SHAN ROAD
 TITLE: T1A FLAT A
 DATE: 11/11/2020
 DRAWN BY: CHOW BR: SCALE: A1: A1
 CHECKED BY: CHOW BR: SCALE: A1: A1
 DATE: 11/11/2020
 TITLE: T1A FLAT A
 DATE: 11/11/2020

ARCHITECT: 香港建築師學會
 STRUCTURAL ENGINEER: C M WONG & ASSOCIATES LTD
 11th & 12th Storey, 100, Des Voeux Road, Central, Hong Kong
 Tel: (852) 2211-1111 Fax: (852) 2211-1111
 PROJECT: RESIDENTIAL DEVELOPMENT AT TSIING YI TOWN LOT 180, SHAH SHAN ROAD
 TITLE: T1A FLAT A
 DATE: 11/11/2020
 DRAWN BY: CHOW BR: SCALE: A1: A1
 CHECKED BY: CHOW BR: SCALE: A1: A1
 DATE: 11/11/2020
 TITLE: T1A FLAT A
 DATE: 11/11/2020

ARCHITECT: 香港建築師學會
 STRUCTURAL ENGINEER: C M WONG & ASSOCIATES LTD
 11th & 12th Storey, 100, Des Voeux Road, Central, Hong Kong
 Tel: (852) 2211-1111 Fax: (852) 2211-1111
 PROJECT: RESIDENTIAL DEVELOPMENT AT TSIING YI TOWN LOT 180, SHAH SHAN ROAD
 TITLE: T1A FLAT A
 DATE: 11/11/2020
 DRAWN BY: CHOW BR: SCALE: A1: A1
 CHECKED BY: CHOW BR: SCALE: A1: A1
 DATE: 11/11/2020
 TITLE: T1A FLAT A
 DATE: 11/11/2020

ARCHITECT: 香港建築師學會
 STRUCTURAL ENGINEER: C M WONG & ASSOCIATES LTD
 11th & 12th Storey, 100, Des Voeux Road, Central, Hong Kong
 Tel: (852) 2211-1111 Fax: (852) 2211-1111
 PROJECT: RESIDENTIAL DEVELOPMENT AT TSIING YI TOWN LOT 180, SHAH SHAN ROAD
 TITLE: T1A FLAT A
 DATE: 11/11/2020
 DRAWN BY: CHOW BR: SCALE: A1: A1
 CHECKED BY: CHOW BR: SCALE: A1: A1
 DATE: 11/11/2020
 TITLE: T1A FLAT A
 DATE: 11/11/2020