

工程指示 / 要求簡箋(E.I.)

工程指示編號：EI / 1655 / 20

修改版次：-

工程編號：J851

工程名稱：青衣 明翹匯

工程項目：確認模圖(鋁柵格)

收件人：羅小姐

發件人：Leung Hin Wai

日期：02/04/2020

要求提供 / 確認 事項：

- |                                    |                                     |                               |
|------------------------------------|-------------------------------------|-------------------------------|
| <input type="checkbox"/> 初步鋁料 B.M. | <input type="checkbox"/> 加工拆圖，然後生產  | <input type="checkbox"/> 尺寸表  |
| <input type="checkbox"/> 正式鋁料 B.M. | <input type="checkbox"/> 技術上資料 / 指示 | <input type="checkbox"/> 報價   |
| <input type="checkbox"/> 配件 B.M.   | <input type="checkbox"/> 樣辦或貨品說明書   | <input type="checkbox"/> 分判合約 |
| <input type="checkbox"/> 其他：_____  |                                     |                               |

內容：

確認模圖。共 6 頁。

請在 \_\_\_\_\_ 前完成上列要求。

附： -

以上項目為：

- 原合約工程包                       原合約工程加 / 減賬                       新工程報價

原因：-

分發東莞各部門：

- ( ) 生產技術總監  連附件    ( ) 技術部     連附件                      ( ) 生產部     連附件    ( ) 機械設計部  連附件  
 ( ) 採購部     連附件    ( / ) 生產統籌部  連附件  
 ( / ) 質檢部     連附件    ( ) 會計部     連附件                      ( ) 報關組     連附件    ( ) 其他 \_\_\_\_\_  連附件

分發香港各部門：

- ( ) 行政部  連附件    ( ) 會計部  連附件    ( ) 統籌部  連附件    ( ) 工程部地盤科文(柄)  連附件  
 ( ) 採購部  連附件    ( ) QS 部  連附件    ( ) 維修部  連附件    ( ) 其他 \_\_\_\_\_  連附件

傳遞編號： HX 0501

發件人簽署：

項目經理簽署：

CUSTOMER	HONGKONG CO.	CUSTOMER APPROVAL		CUST PART NO.	X85704
				SECTION NO.	LH0091292

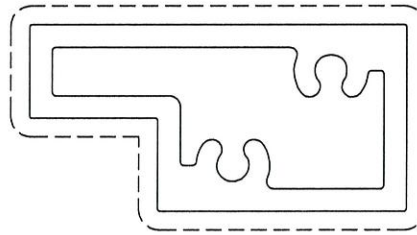
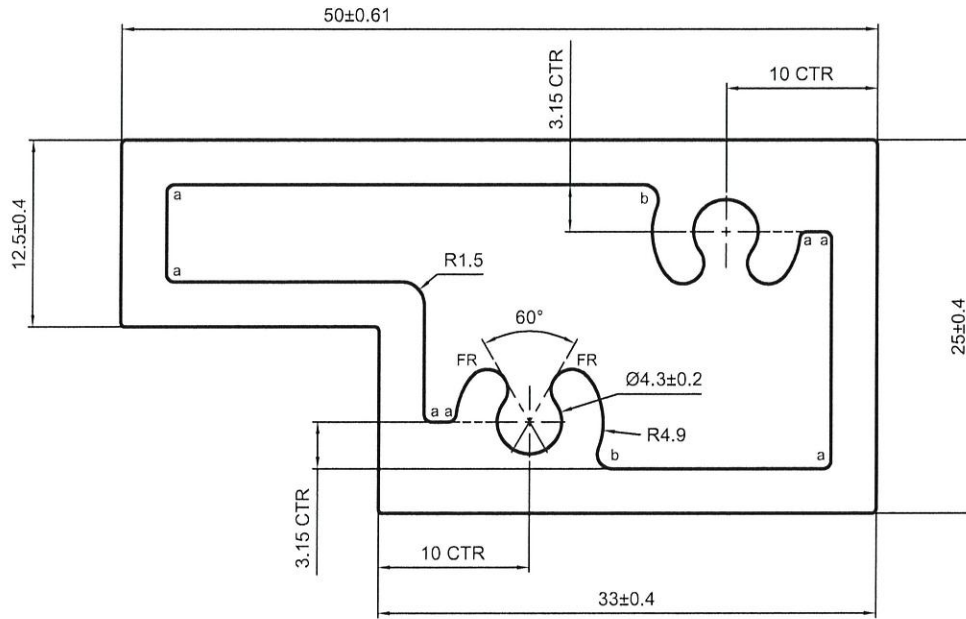

a=R0.5 b=R1

备注：没有配合型号！



V.F

SCALE 1:1

SIGNATURE GRADEING	HIGH SIGNATURE GRADEING	C.C.DIA(MM)	Ø 55.7		喷涂收费周长(mm):		149.23		
AREA (SQ MM)	510.14	UNSPECIFIED THICKNESS	3±0.25	PERIMETER (MM)	149.23	STANDARD	BS EN755	SCALE	2:1
MASS (KG/M)	1.382	UNSPECIFIED CORNERS	R 0.3	SURFACE AREA	149.23	ALLOY	6063-T5	VERSION	A
COMPANY ISSUE		A	DRAWA	陈晓舒	DATE	2020-03-29	APPELLATION	-	PAGE OF
			STANDA-RDIZATION		DATE				
			TO SIGN	陈国提	DATE				
			AUDITING		DATE				
MARKER	MODIFY	FILE NO	SIGNATURE	DATE	APPROV				



PANASIA ALUMINUM (CHINA) LIMITED

CUSTOMER	HONGKONG CO.	CUSTOMER APPROVAL	CUST PART NO.	X85705
			SECTION NO.	LH0091293

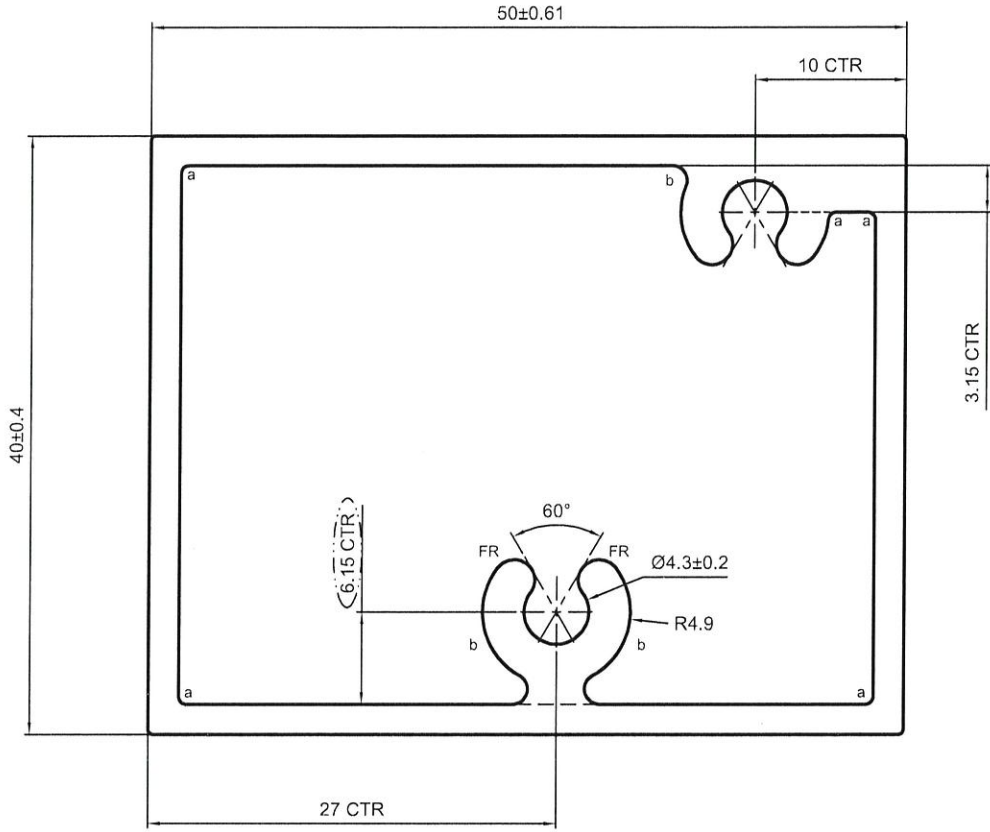

美特鋁質有限公司  
承認圖面  
日期 2/4-2020

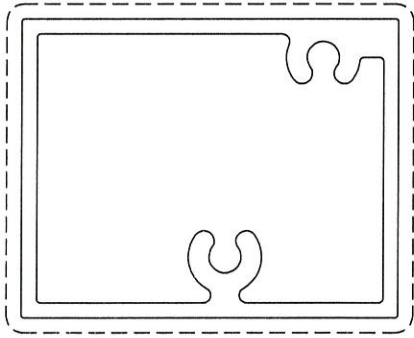

a=R0.5 b=R1

备注：没有配合型号！

V.F

SCALE 1:1

SIGNATURE GRADEING	HIGH SIGNATURE GRADEING	C.C.DIA(MM)	Ø 63.79		喷涂收费周长(mm):		179.48		
AREA (SQ MM)	450.14	UNSPECIFIED THICKNESS	2±0.2	PERIMETER (MM)	179.48	STANDARD	BS EN755	SCALE	2:1
MASS (KG/M)	1.220	UNSPECIFIED CORNERS	R 0.3	SURFACE AREA	179.48	ALLOY	6063-T5	VERSION	B
COMPANY ISSUE		A	DRAWA	陈晓舒	DATE	2020-03-31	APPELLATION	-	PAGE OF
			STANDA-RDIZATION		DATE				
			TO SIGN	陈国提	DATE				
			AUDITING		DATE				
MARKER	MODIFY	FILE NO	SIGNATURE	DATE	APPROV	DATE			



CUSTOMER	HONGKONG CO.	CUSTOMER APPROVAL	CUST PART NO.	X85706
			SECTION NO.	LH0091294

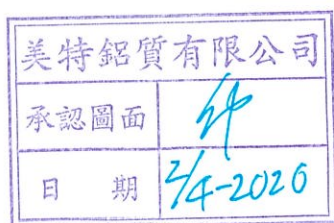
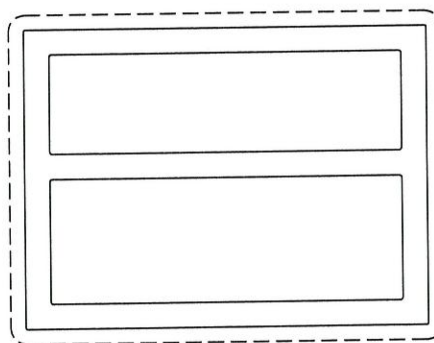
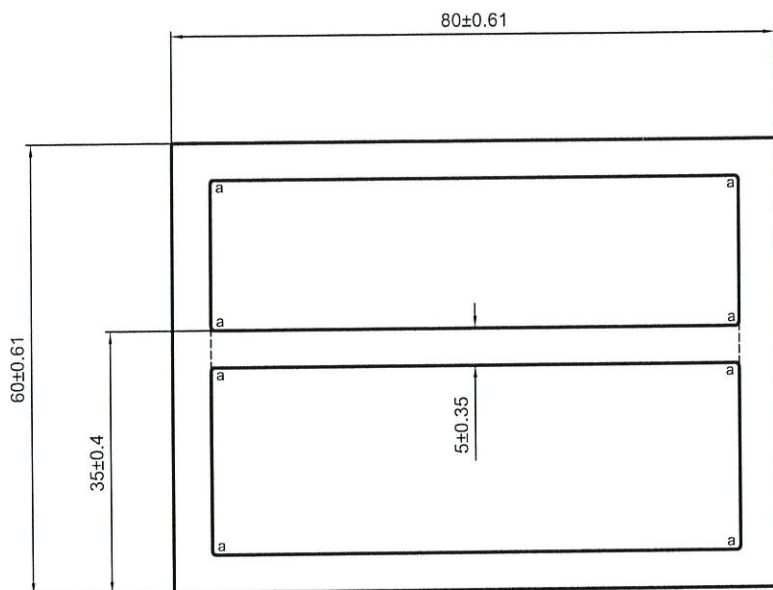

a=R0.5

备注：没有配合型号！

V.F

SCALE 1:1.5

SIGNATURE GRADEING	HIGH SIGNATURE GRADEING	C.C.DIA(MM)	Ø 99.76		喷涂收费周长(mm):				279.48
AREA (SQ MM)	1650.35	UNSPECIFIED THICKNESS	5±0.3	PERIMETER (MM)	279.48	STANDARD	BS EN755	SCALE	1:1
MASS (KG/M)	4.472	UNSPECIFIED CORNERS	R 0.3	SURFACE AREA	279.48	ALLOY	6063-T5	VERSION	A
COMPANY ISSUE		A	DRAWN	陈晓舒	DATE	2020-03-29	APELLATION	-	PAGE OF
			STANDARDIZATION		DATE				
			TO SIGN	陈国提	DATE				
			AUDITING		DATE				
MARKER	MODIFY	FILE NO	SIGNATURE	DATE	APPROV				



**PANSIA ALUMINUM (CHINA) LIMITED**

CUSTOMER	HONGKONG CO.	CUSTOMER APPROVAL	CUST PART NO.	X85707
			SECTION NO.	LH0091295

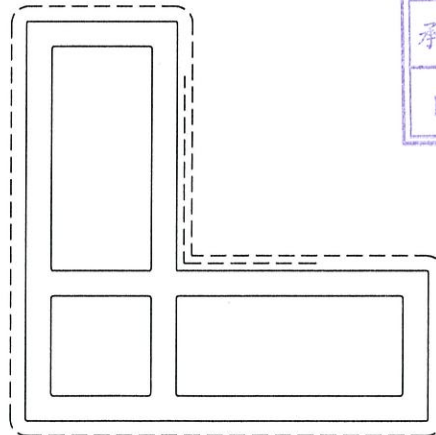
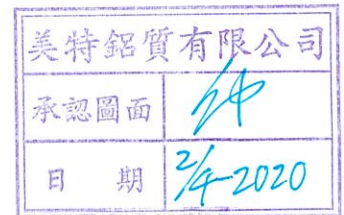
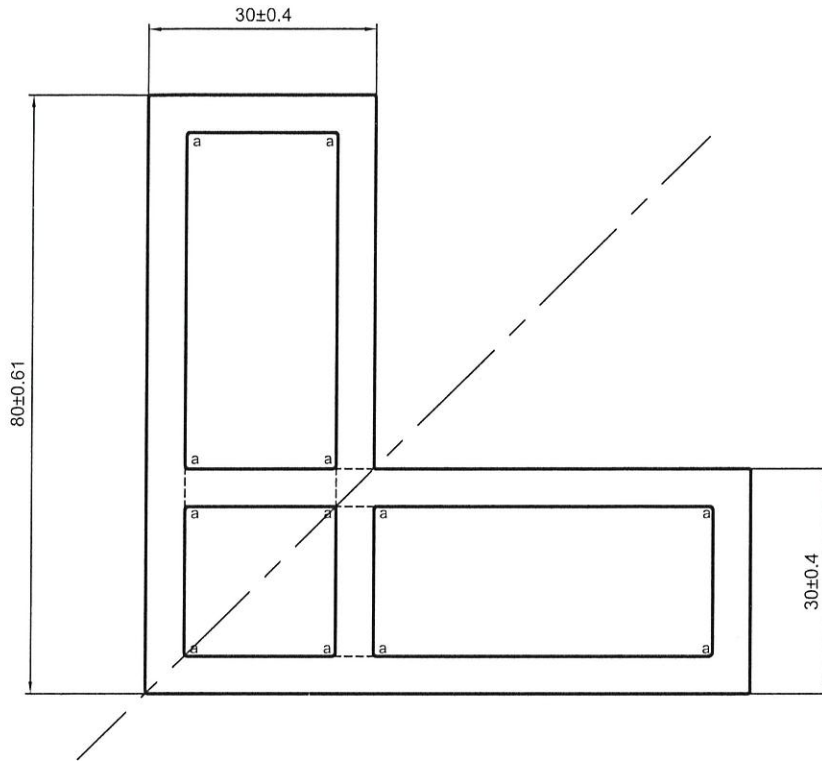

a=R0.5

----- 次要装饰面, 喷涂膜厚不足, 但不露底  
 ----- 装饰面

备注: 没有配合型号!

V.F  
SCALE 1:1.5

SIGNATURE GRADEING	HIGH SIGNATURE GRADEING	C.C.DIA(MM)	Ø 112.89		喷涂收费周长(mm):		319.23		
AREA (SQ MM)	1700.48	UNSPECIFIED THICKNESS	5±0.3	PERIMETER (MM)	319.23	STANDARD	BS EN755	SCALE	1:1
MASS (KG/M)	4.608	UNSPECIFIED CORNERS	R 0.3	SURFACE AREA	319.23	ALLOY	6063-T5	VERSION	A
COMPANY ISSUE		A	DRAWA	陈晓舒	DATE	2020-03-29	APPELLATION	-	PAGE OF
			STANDA-RDIZATION		DATE		 <b>PANASIA ALUMINUM (CHINA) LIMITED</b>		
			TO SIGN	陈国提	DATE				
			AUDITING		DATE				
MARKER	MODIFY	FILE NO	SIGNATURE	DATE	APPROV	DATE			

CUSTOMER	HONGKONG CO.	CUSTOMER APPROVAL	CUST PART NO.	X85807
			SECTION NO.	LH0091296

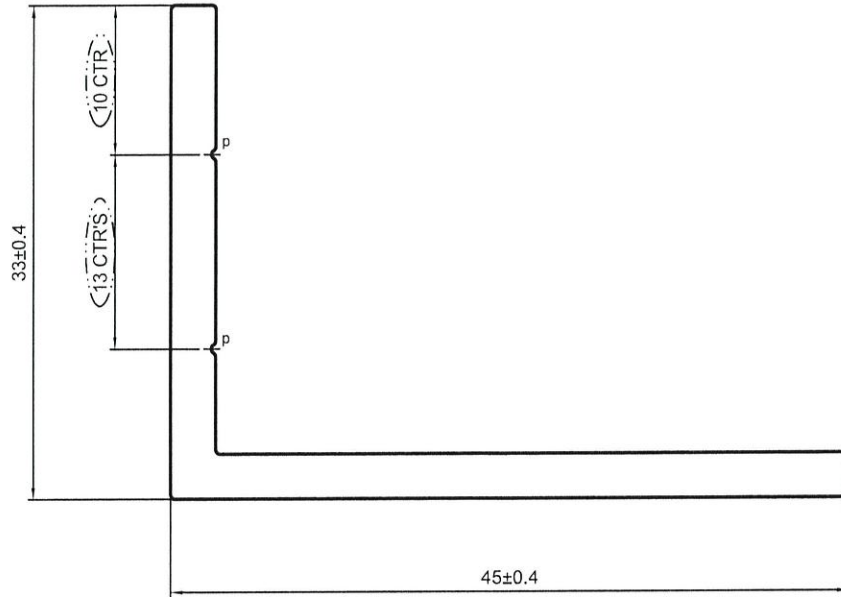

美特鋁質有限公司	
承認圖面	<i>[Signature]</i>
日期	2/4-2020

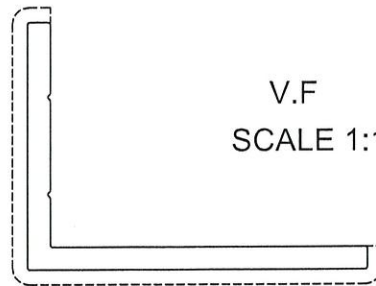

<p=R0.3X0.3>

备注：没有配合型号！

SIGNATURE GRADEING	HIGH SIGNATURE GRADEING	C.C.DIA(MM)	Ø 55.57		喷涂收费周长(mm):		83.96		
AREA (SQ MM)	224.61	UNSPECIFIED THICKNESS	3±0.25	PERIMETER (MM)	155.66	STANDARD	BS EN755	SCALE	2:1
MASS (KG/M)	0.608	UNSPECIFIED CORNERS	R 0.3	SURFACE AREA	83.96	ALLOY	6063-T5	VERSION	B
COMPANY ISSUE		A	DRAWA	陈晓舒	DATE	2020-03-31	APPELLATION	-	PAGE OF
			STANDA-RDIZATION		DATE				
			TO SIGN	陈国提	DATE				
			AUDITING		DATE				
MARKER	MODIFY	FILE NO	SIGNATURE	DATE	APPROV				

 PANASIA ALUMINUM (CHINA) LIMITED

CUSTOMER	HONGKONG CO.	CUSTOMER APPROVAL	CUST PART NO.	X85808
			SECTION NO.	LH0091297

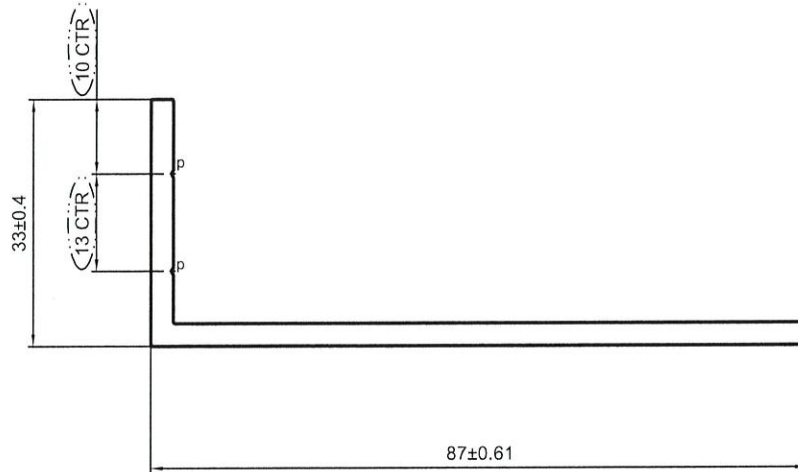

美特鋁質有限公司	
承認圖面	<i>Handwritten signature</i>
日期	2/4-2020

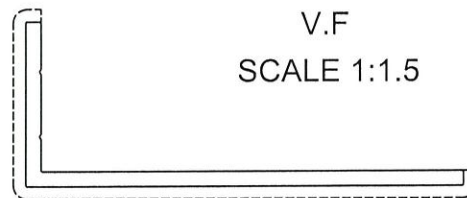

$p=R0.3 \times 0.3$

备注：没有配合型号！

SIGNATURE GRADEING	HIGH SIGNATURE GRADEING	C.C.DIA(MM)	Ø 92.88		喷涂收费周长(mm):		125.96		
AREA (SQ MM)	350.61	UNSPECIFIED THICKNESS	3±0.25	PERIMETER (MM)	239.66	STANDARD	BS EN755	SCALE 1:1	
MASS (KG/M)	0.950	UNSPECIFIED CORNERS	R 0.3	SURFACE AREA	125.96	ALLOY	6063-T5	VERSION B	
COMPANY ISSUE		A	DRAWA	陈晓舒	DATE	2020-03-31	APELLATION	-	PAGE OF
			STANDA-RDIZATION		DATE				
			TO SIGN	陈国提	DATE				
			AUDITING		DATE				
MARKER	MODIFY	FILE NO	SIGNATURE	DATE	APPROV		DATE		