



工程指示 / 要求簡箋(E.I.)

工程指示編號：EI/1465/20

修改版次：-

工程編號：J851

工程名稱：青衣 明翹匯

工程項目：確認模圖(預制窗)

收件人：羅小姐

發件人：Leung Hin Wai

日期：16/01/2020

要求提供 / 確認 事項：

- |                                    |                                     |                               |
|------------------------------------|-------------------------------------|-------------------------------|
| <input type="checkbox"/> 初步鋁料 B.M. | <input type="checkbox"/> 加工拆圖，然後生產  | <input type="checkbox"/> 尺寸表  |
| <input type="checkbox"/> 正式鋁料 B.M. | <input type="checkbox"/> 技術上資料 / 指示 | <input type="checkbox"/> 報價   |
| <input type="checkbox"/> 配件 B.M.   | <input type="checkbox"/> 樣辦或貨品說明書   | <input type="checkbox"/> 分判合約 |
| <input type="checkbox"/> 其他：_____  |                                     |                               |

內容：

現確認附頁模圖。共10頁。

請在\_\_\_\_\_前完成上列要求。

附：-

1 + 10頁

以上項目為：

- 原合約工程包                       原合約工程加 / 減賬                       新工程報價

原因：-

分發東莞各部門：

- ( ) 生產技術總監  連附件    ( ) 技術部     連附件    ( ) 生產部     連附件    ( ) 機械設計部  連附件  
 ( ) 採購部     連附件    ( / ) 生產統籌部  連附件  
 ( / ) 質檢部     連附件    ( ) 會計部     連附件    ( ) 報關組     連附件    ( ) 其他 \_\_\_\_\_  連附件

分發香港各部門：

- ( ) 行政部  連附件    ( ) 會計部  連附件    ( ) 統籌部  連附件    ( ) 工程部地盤科文(柄)  連附件  
 ( ) 採購部  連附件    ( ) QS 部     連附件    ( ) 維修部  連附件    ( ) 其他 \_\_\_\_\_  連附件

傳遞編號：

H2K 0087

發件人簽署：

項目經理簽署：

CUSTOMER	HONGKONG CO.	CUSTOMER APPROVAL	CUST PART NO.	X85678
			SECTION NO.	LH0091085

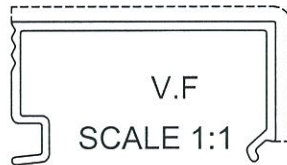
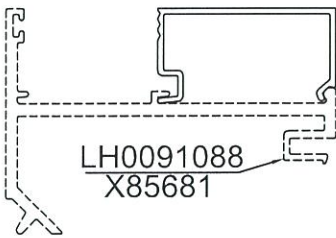
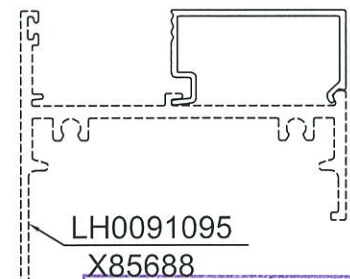
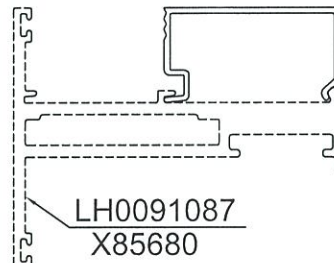
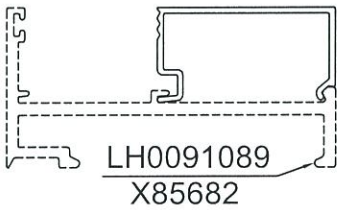
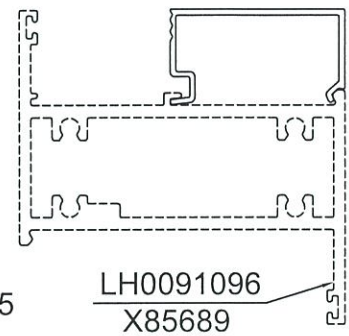
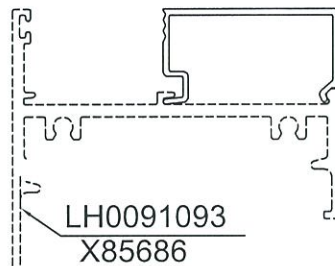
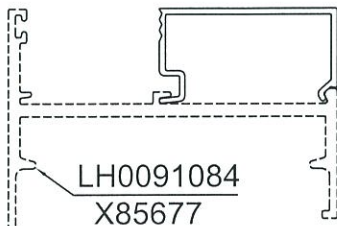
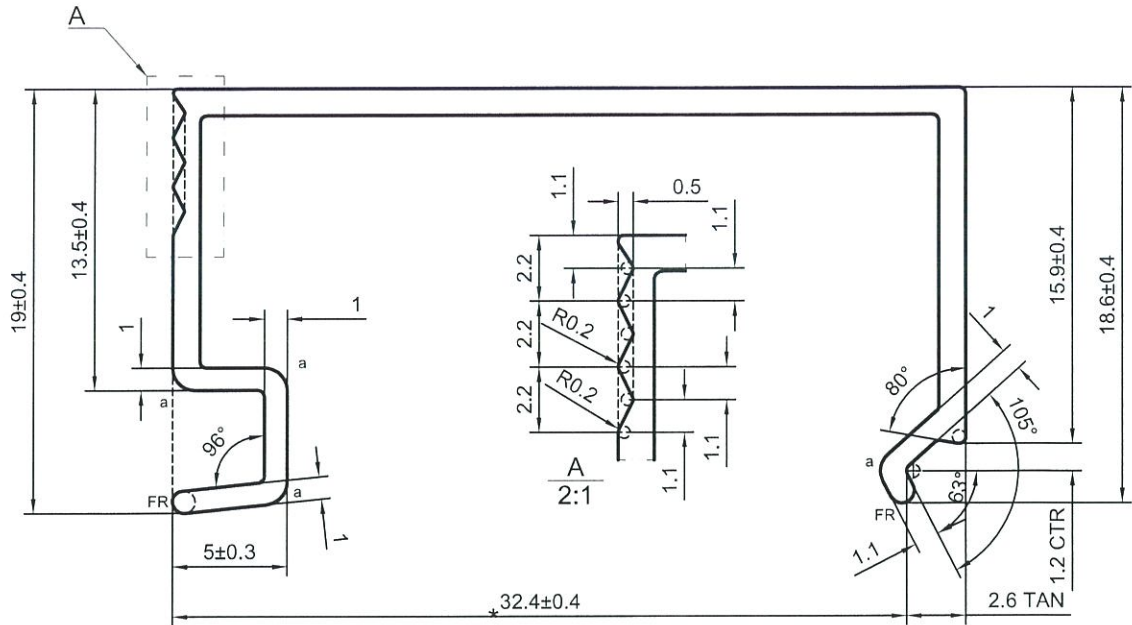

a=R1

\*配合尺寸以实物配合效果为准!

美特鋁質有限公司  
承認圖面  
日期 16/1-2020

SIGNATURE GRADEING	HIGH SIGNATURE GRADEING	C.C.DIA(MM)	Ø 39.54		噴涂收費周長(mm): 51.27				
AREA (SQ MM)	89.58	UNSPECIFIED THICKNESS	1.2±0.15	PERIMETER (MM)	158.40	STANDARD	BS EN755	SCALE	3:1
MASS (KG/M)	0.243	UNSPECIFIED CORNERS	R 0.3	SURFACE AREA	51.27	ALLOY	6063-T5	VERSION	A
		DRAWN	陈晓舒	DATE	2020-01-07	APPELLATION	-	PAGE OF	
		STANDARDIZATION		DATE					
		TO SIGN	陈国提	DATE					
		AUDITING		DATE					
MARKER	MODIFY	FILE NO	SIGNATURE	DATE	APPROV	DATE			

CUSTOMER	HONGKONG CO.	CUSTOMER APPROVAL	CUST PART NO.	X85679
			SECTION NO.	LH0091086

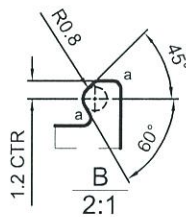
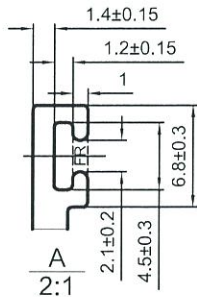
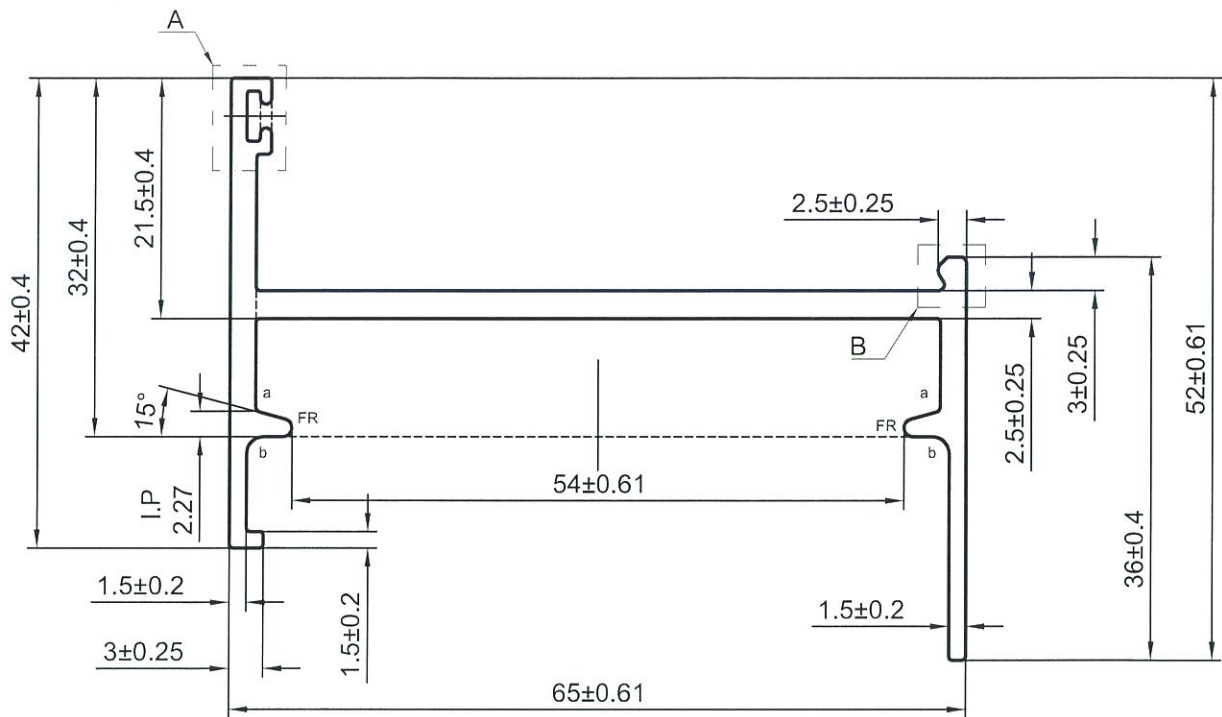

美特铝质有限公司	
承認圖面	<i>[Signature]</i>
日期	16/1-2020

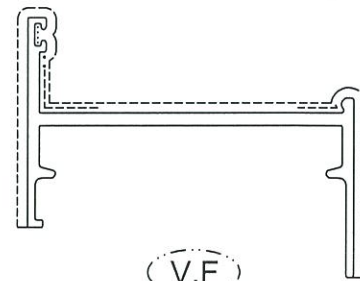

(V.F)  
SCALE 1:1.5

a=R0.5 b=R1.5

----- 次要装饰面, 喷涂膜厚不足, 但不露底

----- 装饰面

●●●●● 凹槽位置可能会有露底现象, 即膜厚不足

备注: 没有配合型号!

SIGNATURE GRADEING	HIGH SIGNATURE GRADEING	C.C.DIA(MM)	Ø 83		喷涂收费周长(mm): 174.82				
AREA (SQ MM)	321.79	UNSPECIFIED THICKNESS	2.3±0.2	PERIMETER (MM)	301.20	STANDARD	BS EN755	SCALE	1.5:1
MASS (KG/M)	0.872	UNSPECIFIED CORNERS	R 0.3	SURFACE AREA	174.82	ALLOY	6063-T6	VERSION	A
		DRAWN	陈晓舒	DATE	2020-01-07	APPELLATION	PAGE OF		
		STANDARDIZATION		DATE					
		TO SIGN	陈国提	DATE					
		AUDITING		DATE					
MARKER	MODIFY	FILE NO	SIGNATURE	DATE	APPROV	DATE			

 PANASIA ALUMINUM (CHINA) LIMITED

CUSTOMER	HONGKONG CO.	CUSTOMER APPROVAL	CUST PART NO.	X85683
			SECTION NO.	LH0091090

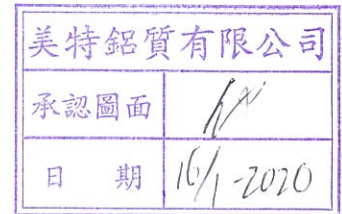
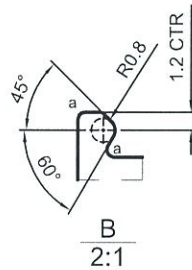
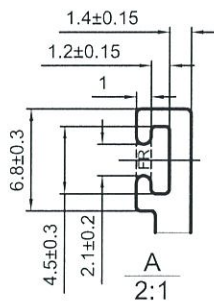
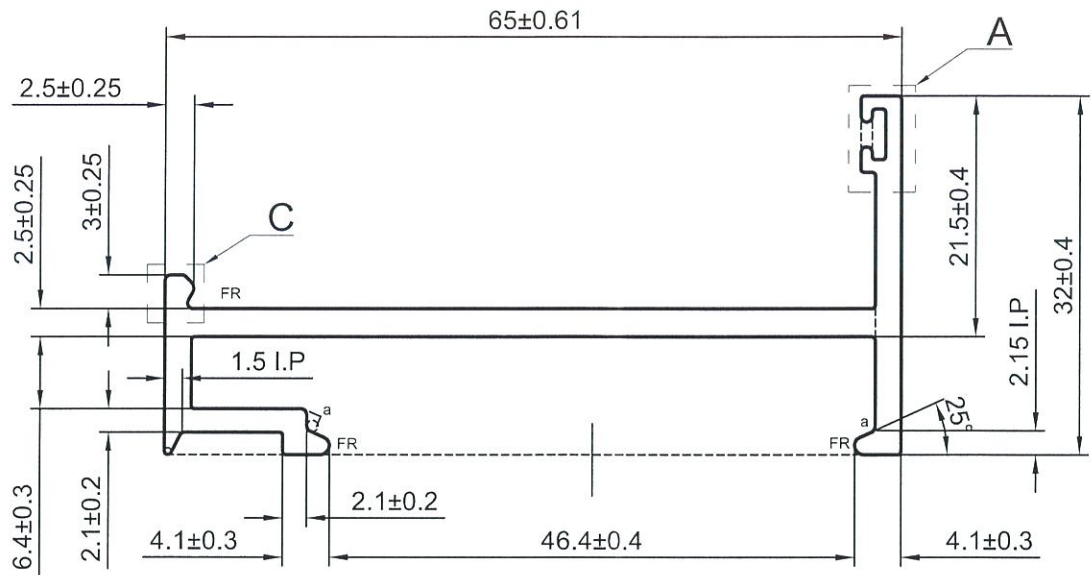

(V.F)  
SCALE 1:1

a=R0.5

----- 次要装饰面，喷涂膜厚不足，但不露底

----- 装饰面

●●●●●● 凹槽位置可能会有露底现象，即膜厚不足

备注：没有配合型号！

SIGNATURE GRADEING	HIGH SIGNATURE GRADEING	C.C.DIA(MM)	Ø 72.25		喷涂收费周长(mm):		144.95		
AREA (SQ MM)	291.38	UNSPECIFIED THICKNESS	2.3±0.2	PERIMETER (MM)	257.88	STANDARD	BS EN755	SCALE	1.5:1
MASS (KG/M)	0.790	UNSPECIFIED CORNERS	R 0.3	SURFACE AREA	144.95	ALLOY	6063-T6	VERSION	A
		DRAWN	陈晓舒	DATE	2020-01-07	APELLATION	PAGE OF		
		STANDARDIZATION		DATE					
		TO SIGN	陈国提	DATE					
		AUDITING		DATE					
MARKER	MODIFY	FILE NO	SIGNATURE	DATE	APPROV	DATE			



PANASIA ALUMINUM  
(CHINA) LIMITED

CUSTOMER	HONGKONG CO.	CUSTOMER APPROVAL	CUST PART NO.	X85684
			SECTION NO.	LH0091091

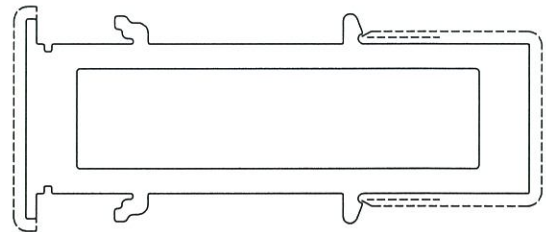
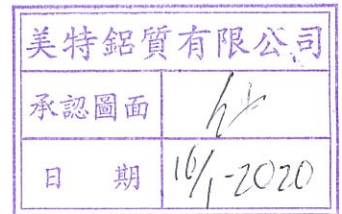
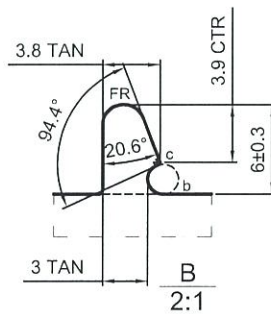
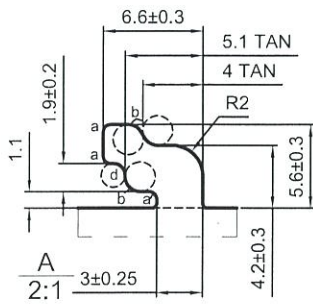
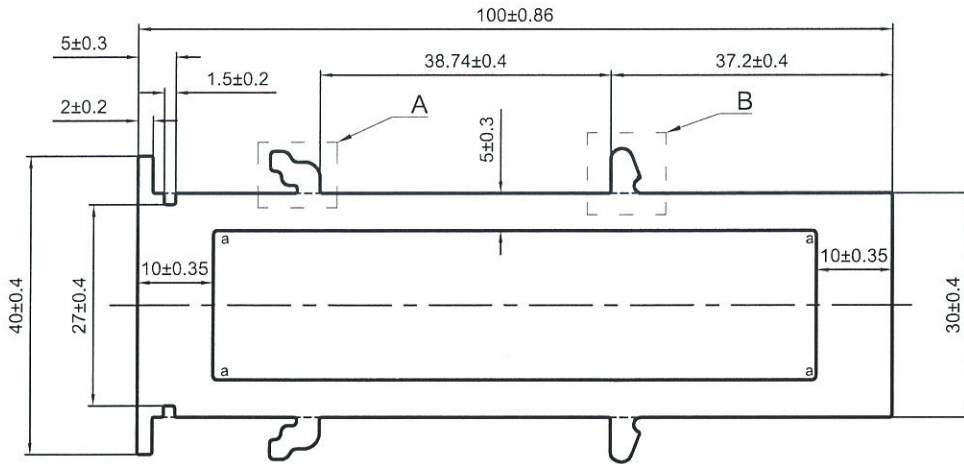

a=R0.5 b=R1 c=R0.2 d=R0.8

----- 次要装饰面，喷涂膜厚不足，但不露底

----- 装饰面

备注：没有配合型号！

(V.F)

SCALE 1:1.5

SIGNATURE GRADEING	HIGH SIGNATURE GRADEING	C.C.DIA(MM)	Ø 105.92		喷涂收费周长(mm):		140.22		
AREA (SQ MM)	1499.35	UNSPECIFIED THICKNESS	2.3±0.2	PERIMETER (MM)	335.15	STANDARD	BS EN755	SCALE	1:1
MASS (KG/M)	4.063	UNSPECIFIED CORNERS	R 0.3	SURFACE AREA	140.22	ALLOY	6063-T6	VERSION	A
		DRAWA	陈晓舒	DATE	2020-01-07	APPELLATION	PAGE OF		
		STANDA-RDIZATION		DATE					
		TO SIGN	陈国提	DATE					
		AUDITING		DATE					
MARKER	MODIFY	FILE NO	SIGNATURE	DATE	APPROV	DATE			



PANASIA ALUMINUM (CHINA) LIMITED

CUSTOMER	HONGKONG CO.	CUSTOMER APPROVAL	CUST PART NO.	X85685
			SECTION NO.	LH0091092

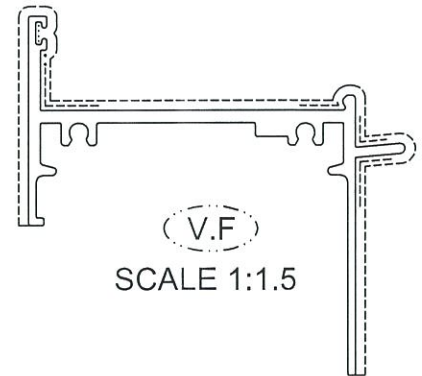
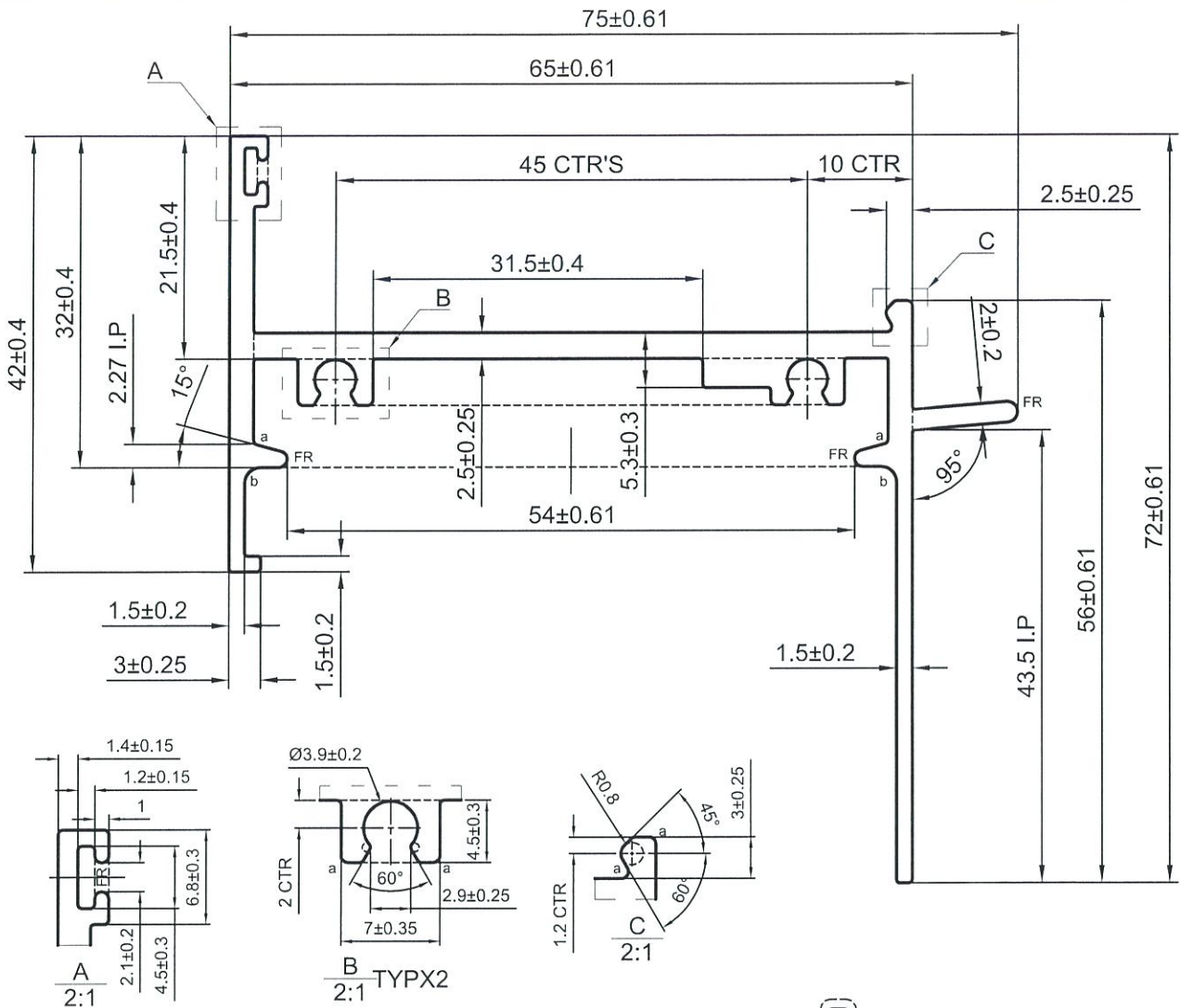

美特鋁質有限公司  
承認圖面  
日期 16/1-2020

a=R0.5 b=R1.5

----- 次要裝飾面，噴塗膜厚不足，但不露底

----- 裝飾面

●●●●●● 凹槽位置可能有露底現象，即膜厚不足

备注：没有配合型号！

SIGNATURE GRADEING	HIGH SIGNATURE GRADEING	C.C.DIA(MM)	Ø 96.75		噴塗收費周長(mm):		213.77		
AREA (SQ MM)	424	UNSPECIFIED THICKNESS	2.3±0.2	PERIMETER (MM)	391.47	STANDARD	BS EN755	SCALE	1.5:1
MASS (KG/M)	1.149	UNSPECIFIED CORNERS	R 0.3	SURFACE AREA	213.77	ALLOY	6063-T6	VERSION	A
		DRAWN	陈晓舒	DATE	2020-01-07	APPELLATION	PAGE OF		
		STANDARDIZATION		DATE					
		TO SIGN	陈国提	DATE					
		AUDITING		DATE					
MARKER	MODIFY	FILE NO	SIGNATURE	DATE	APPROV	DATE			

CUSTOMER	HONGKONG CO.	CUSTOMER APPROVAL	CUST PART NO.	X85687
			SECTION NO.	LH0091094

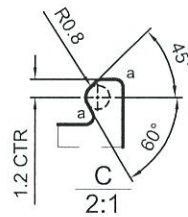
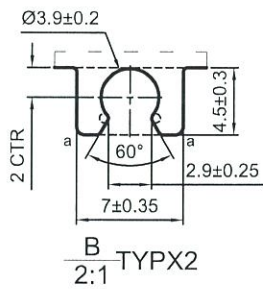
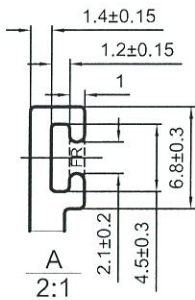
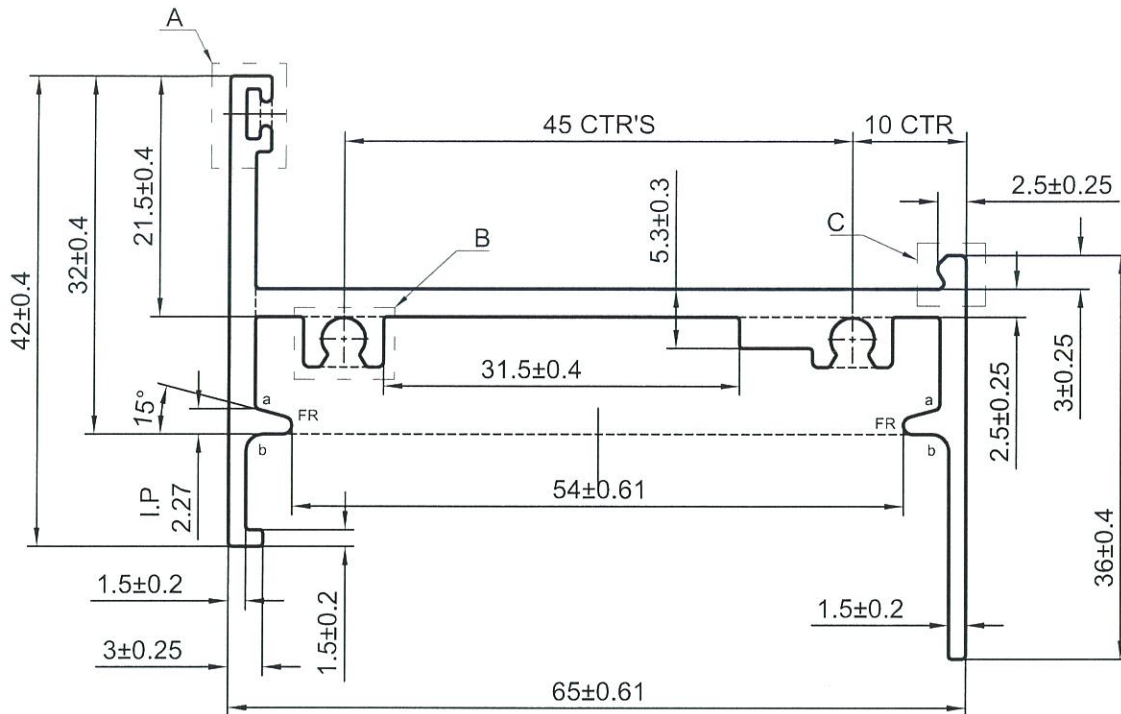

美特鋁質有限公司  
承認圖面  
日期 16/1/2020

a=R0.5 b=R1.5

----- 次要裝飾面, 噴塗膜厚不足, 但不露底

----- 裝飾面

●●●●● 凹槽位置可能會有露底現象, 即膜厚不足

备注: 沒有配合型号!

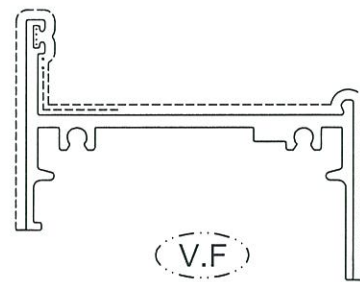

SCALE 1:1.5

SIGNATURE GRADEING	HIGH SIGNATURE GRADEING	C.C.DIA(MM)	Ø 83		噴塗收費周長(mm):		174.82		
AREA (SQ MM)	374.3	UNSPECIFIED THICKNESS	2.3±0.2	PERIMETER (MM)	332.52	STANDARD	BS EN755	SCALE	1.5:1
MASS (KG/M)	1.014	UNSPECIFIED CORNERS	R 0.3	SURFACE AREA	174.82	ALLOY	6063-T6	VERSION	A
		DRAWN	陈晓舒	DATE	2020-01-07	APELLATION	PAGE OF		
		STANDARDIZATION		DATE					
		TO SIGN	陈国提	DATE					
		AUDITING		DATE					
MARKER	MODIFY	FILE NO	SIGNATURE	DATE	APPROV	DATE			

PANASIA ALUMINUM (CHINA) LIMITED

CUSTOMER	HONGKONG CO.	CUSTOMER APPROVAL	CUST PART NO.	X85690
			SECTION NO.	LH0091097

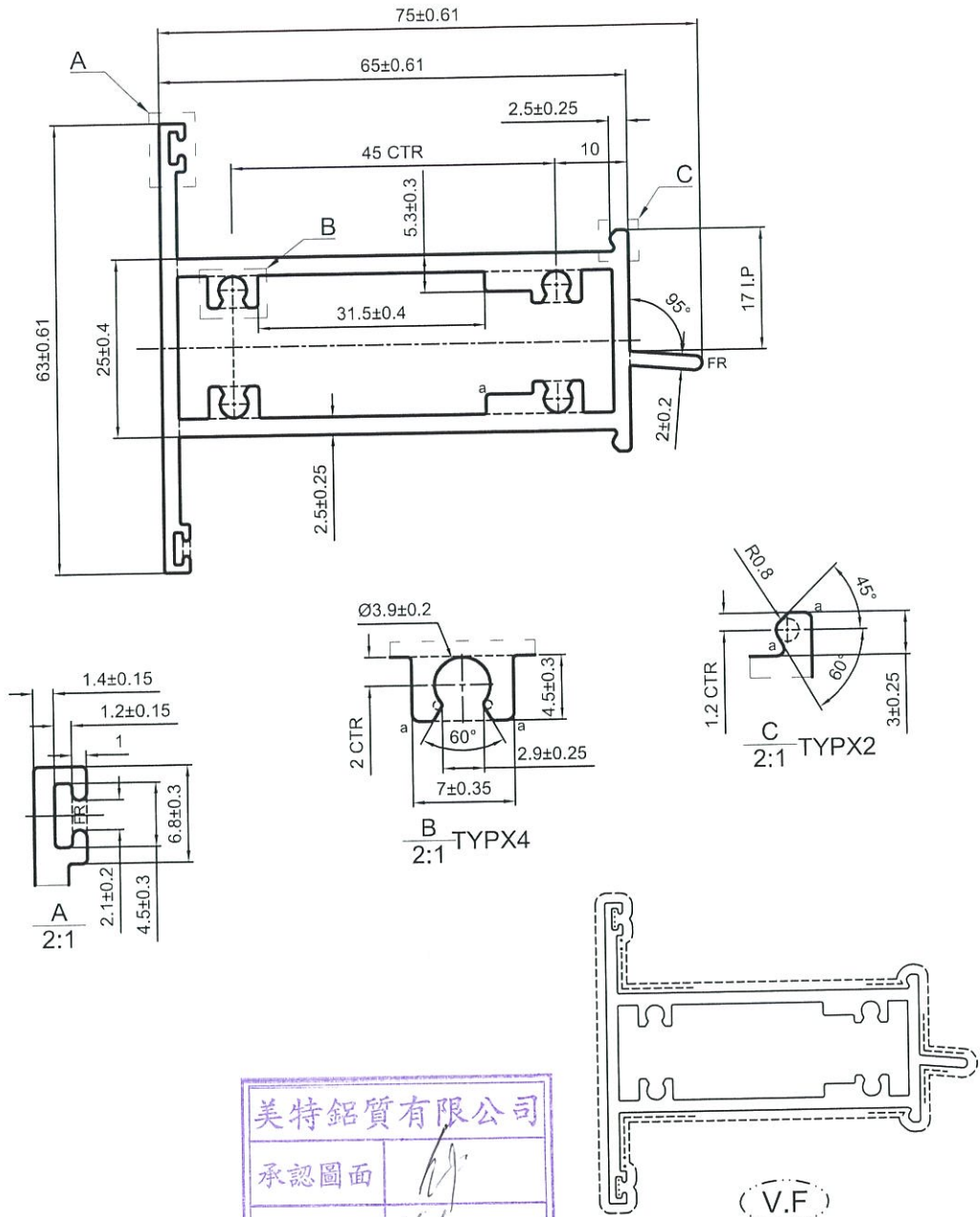

美特鋁質有限公司  
承認圖面  
日期 16/1-2020

a=R0.5

----- 次要裝飾面，噴塗膜厚不足，但不露底  
----- 裝飾面

●●●●●● 凹槽位置可能會有露底現象，即膜厚不足

备注：没有配合型号！

(V.F)  
SCALE 1:1.5

SIGNATURE GRADEING	HIGH SIGNATURE GRADEING	C.C.DIA(MM)	Ø 88.19			喷涂收费周长(mm):		305.90	
AREA (SQ MM)	643.72	UNSPECIFIED THICKNESS	2.3±0.2	PERIMETER (MM)	305.90	STANDARD	BS EN755	SCALE	1:1
MASS (KG/M)	1.744	UNSPECIFIED CORNERS	R 0.3	SURFACE AREA	305.90	ALLOY	6063-T6	VERSION	A
		DRAWN	陈晓舒	DATE	2020-01-07	APPELLATION	PAGE OF		
		STANDARDIZATION		DATE					
		TO SIGN	陈国提	DATE					
		AUDITING		DATE					
MARKER	MODIFY	FILE NO	SIGNATURE	DATE	APPROV				

CUSTOMER	HONGKONG CO.	CUSTOMER APPROVAL	CUST PART NO.	X85691
			SECTION NO.	LH0091098

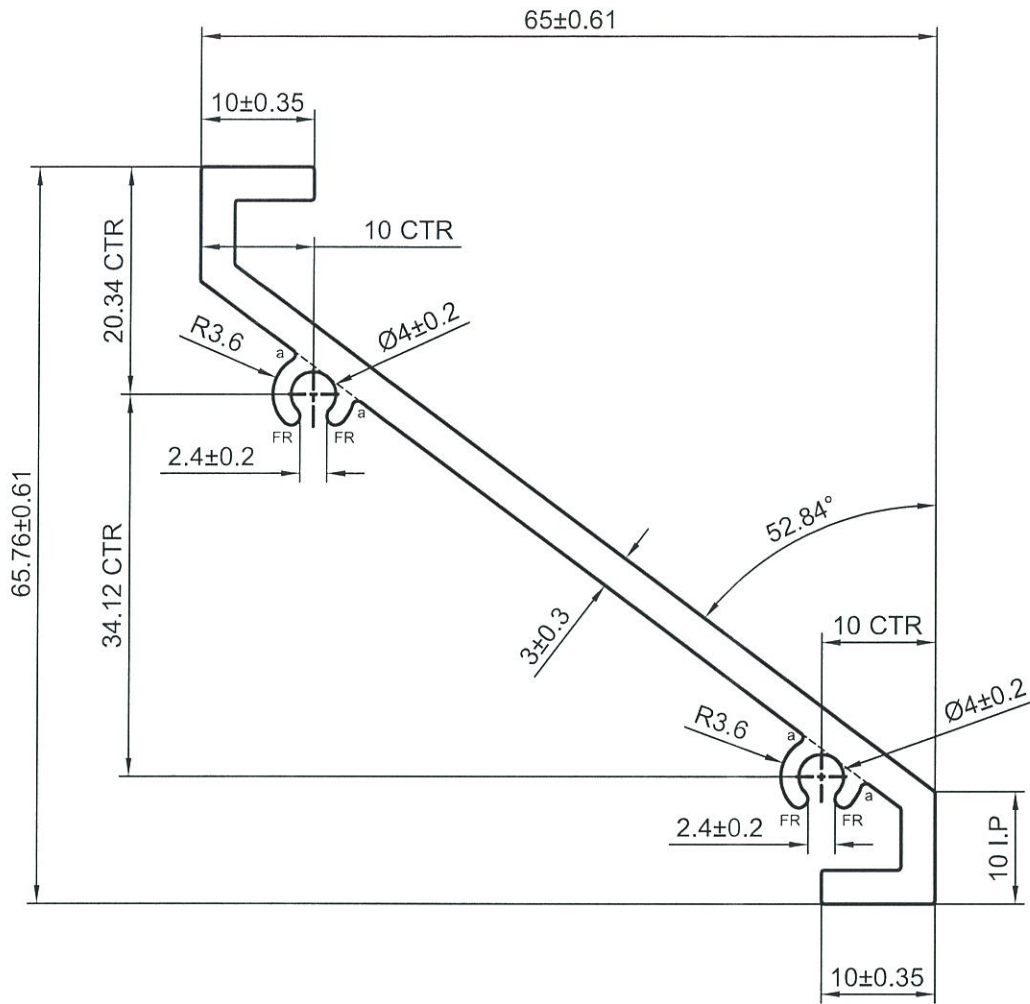

美特鋁質有限公司  
承認圖面  
日期 16/1-2020

a=R0.5

- 次要裝飾面, 噴塗膜厚不足, 但不露底
- 裝飾面
- 凹槽位置可能會有露底現象, 即膜厚不足

备注: 没有配合型号!

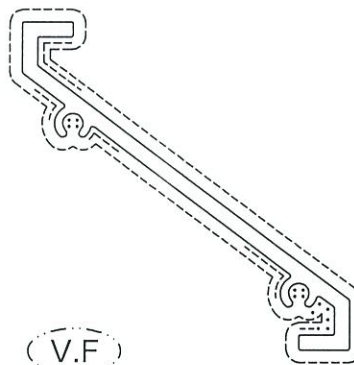

SCALE 1:1.5

SIGNATURE GRADEING	HIGH SIGNATURE GRADEING	C.C.DIA(MM)	Ø 92.21		噴塗收費周長(mm):		260.0		
AREA (SQ MM)	364.76	UNSPECIFIED THICKNESS	3±0.25	PERIMETER (MM)	260.0	STANDARD	BS EN755	SCALE	1.5:1
MASS (KG/M)	0.988	UNSPECIFIED CORNERS	R 0.3	SURFACE AREA	260.0	ALLOY	6063-T6	VERSION	A
		DRAWN	陈晓舒	DATE	2020-01-07	APELLATION	-	PAGE OF	
		STANDARDIZATION		DATE					
		TO SIGN	陈国提	DATE					
		AUDITING		DATE					
MARKER	MODIFY	FILE NO	SIGNATURE	DATE	APPROV	DATE			

CUSTOMER	HONGKONG CO.	CUSTOMER APPROVAL	CUST PART NO.	X85693
			SECTION NO.	LH0091111

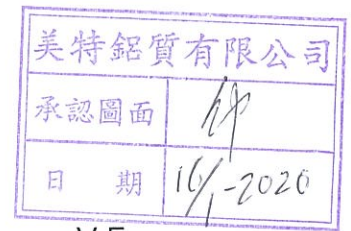
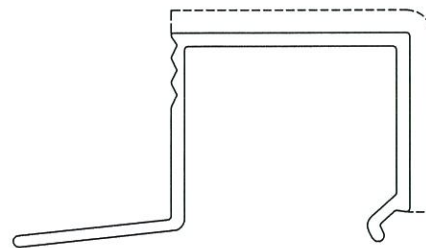
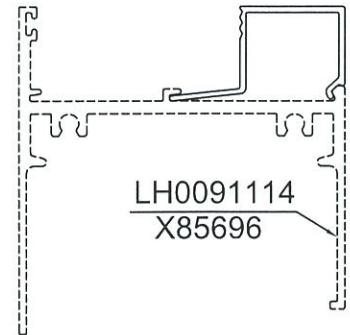
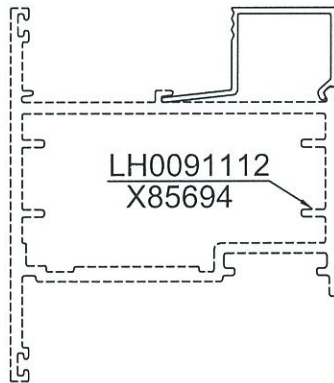
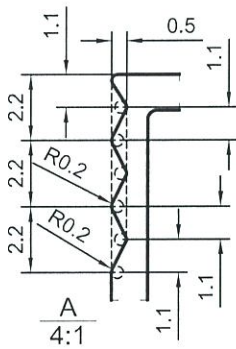
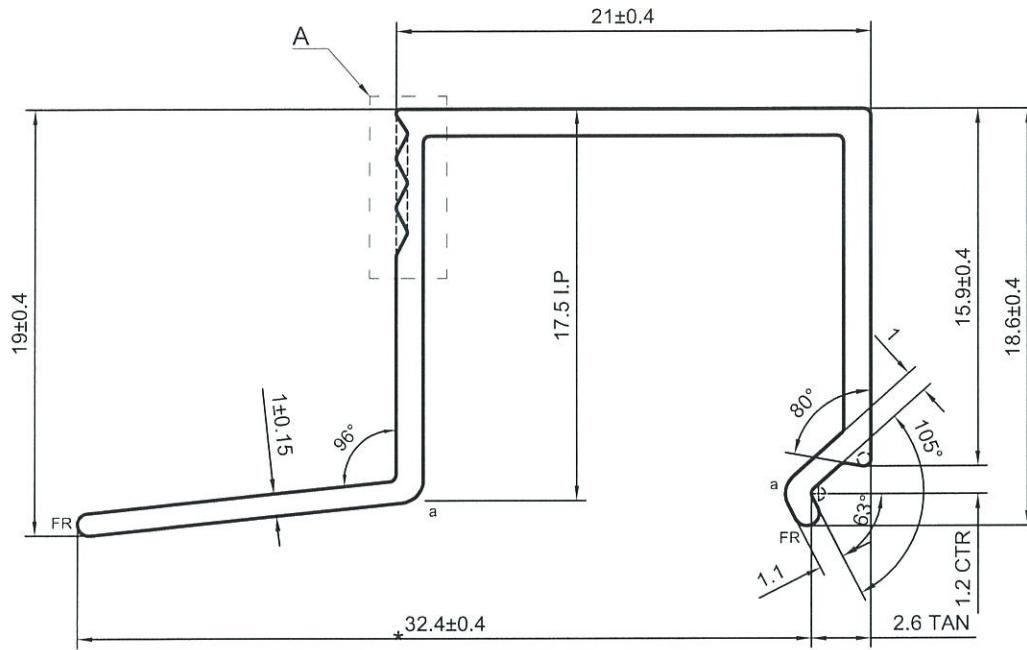

V.F

SCALE 1.5:1

a=R1

\*配合尺寸以实物配合效果为准!

SIGNATURE GRADEING	HIGH SIGNATURE GRADEING	C.C.DIA(MM)	Ø 39.56		喷涂收费周长(mm):		37.27		
AREA (SQ MM)	79.17	UNSPECIFIED THICKNESS	1.2±0.15	PERIMETER (MM)	142.09	STANDARD	BS EN755	SCALE	3:1
MASS (KG/M)	0.215	UNSPECIFIED CORNERS	R 0.3	SURFACE AREA	37.27	ALLOY	6063-T5	VERSION	A
		DRAWN	陈晓舒	DATE	2020-01-07	APELLATION	PAGE OF		
		STANDARDIZATION		DATE					
		TO SIGN	陈国提	DATE					
		AUDITING		DATE					
MARKER	MODIFY	FILE NO	SIGNATURE	DATE	APPROV	DATE			



PANSIA ALUMINUM (CHINA) LIMITED

CUSTOMER	HONGKONG CO.	CUSTOMER APPROVAL	CUST PART NO.	X85697
			SECTION NO.	LH0091115

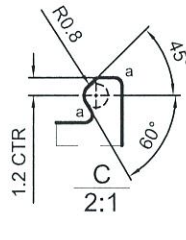
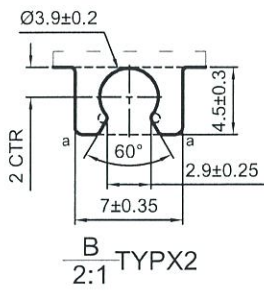
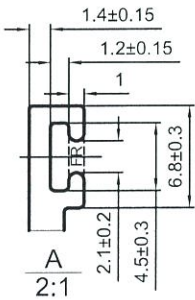
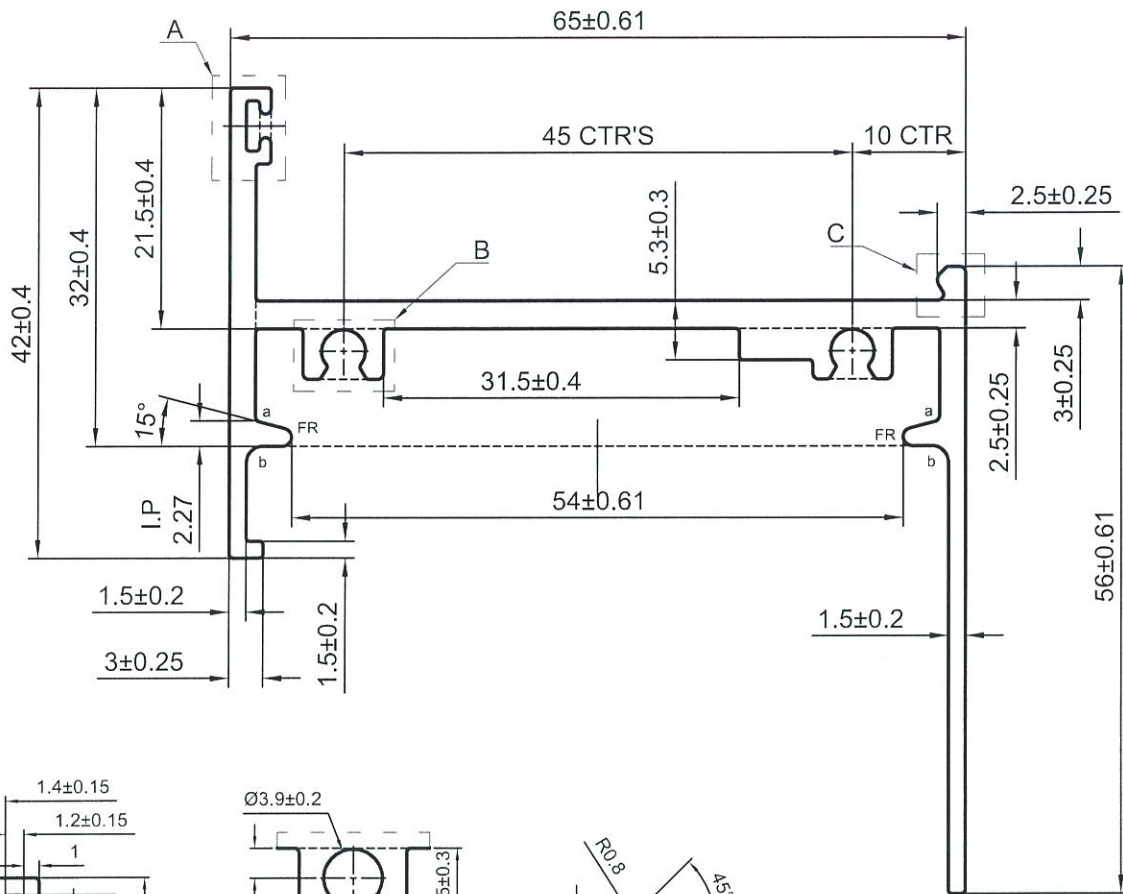

美特鋁質有限公司  
承認圖面  
日期 10/1-2020

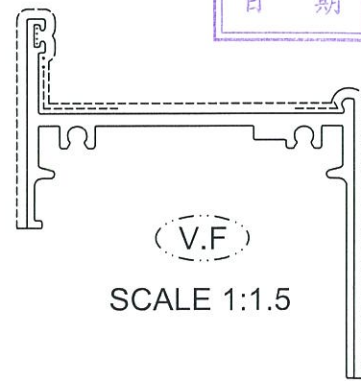

a=R0.5 b=R1.5

----- 次要装饰面, 喷涂膜厚不足, 但不露底  
----- 装饰面  
●●●●● 凹槽位置可能会有露底现象, 即膜厚不足  
备注: 没有配合型号!

SIGNATURE GRADEING	HIGH SIGNATURE GRADEING	C.C.DIA(MM)	Ø 96.75		喷涂收费周长(mm):		194.82		
AREA (SQ MM)	404.3	UNSPECIFIED THICKNESS	2.3±0.2	PERIMETER (MM)	372.52	STANDARD	BS EN755	SCALE	1.5:1
MASS (KG/M)	1.096	UNSPECIFIED CORNERS	R 0.3	SURFACE AREA	194.82	ALLOY	6063-T6	VERSION	A
DRAWN			陈晓舒	DATE	2020-01-10	APPELLATION		PAGE OF	
STANDARDIZATION				DATE					
TO SIGN			陈国提	DATE					
AUDITING				DATE					
MARKER	MODIFY	FILE NO	SIGNATURE	DATE	APPROV				

PANASIA ALUMINUM (CHINA) LIMITED