



工程指示 / 要求簡箋(E.I.)

工程指示編號：EI / 9894 / 18

修改版次：B

工程編號：J - 837

工程名稱：觀塘裕民坊

工程項目：幕牆 鋁料模具生產(16 個)

收件人：Maggie

發件人：Eric Liu

日期：07/12/2018

要求提供 / 確認 事項：

- | | | |
|------------------------------------|-------------------------------------|-------------------------------|
| <input type="checkbox"/> 初步鋁料 B.M. | <input type="checkbox"/> 加工拆圖，然後生產 | <input type="checkbox"/> 尺寸表 |
| <input type="checkbox"/> 正式鋁料 B.M. | <input type="checkbox"/> 技術上資料 / 指示 | <input type="checkbox"/> 報價 |
| <input type="checkbox"/> 配件 B.M. | <input type="checkbox"/> 樣辦或貨品說明書 | <input type="checkbox"/> 分判合約 |
| <input type="checkbox"/> 其他：_____ | | |

內容：

請留意，因 EI9685 已到 J 版，無法再登記，EI9894 為 EI9658 修改版

1) 簽批模圖 16 個(SD 及背板用)

謝謝！

請在 2018/12/21 前完成上列要求。

附：17 頁模圖+1 頁

以上項目為：

- 原合約工程包 原合約工程加 / 減賬 新工程報價

原因：-

分發東莞各部門：

- () 生產技術總監 連附件 () 技術部 連附件 林 () 生產部 連附件 () 機械設計部 連附件
 () 採購部 連附件 () 生產統籌部 連附件 梅
 () 質檢部 連附件 () 會計部 連附件 () 報關組 連附件 () 其他 楊榮輝 連附件
 分發其他分判：張

() 王禮秋 連附件

分發香港各部門：

- () 行政部 連附件 () 會計部 連附件 () 統籌部 連附件 () 工程部地盤科文 連附件
 () 採購部 連附件 () QS 部 連附件 () 維修部 連附件 () 其他 _____ 連附件

傳遞編號：

HK 187218

發件人簽署：

項目經理簽署：

類別	名稱	Page	PART	Grade	榮陽DIE No.	Die No.	0	A	B	C	D
企橫	雙梗企	1	M1	6063	T6	LH0089912	X85545				
企橫	生梗企	2	M2	6063	T6	LH0089913	X85546				
企橫	雙生企	3	M3	6063	T6	LH0089914	X85547				
企橫	SD中企(90)	4	M4	6063	T6	LH0089915	X85548				
企橫	轉角企	5	M5	6063	T6	LH0090004	X85549				
企橫	邊企	6	M6	6063	T6	LH0089916	X85550				
企橫	雙生托	7	M7	6063	T6	LH0089917	X85551				
企橫	雙梗橫料	8	T1	6063	T6	LH0089918	X85552				
企橫	生梗橫料	9	T2	6063	T6	LH0089919	X85553				
企橫	SD窗頂橫(單玻)	10	T3	6063	T6	LH0089920	X85554				
企橫	SD窗頂橫(雙玻)	11	T3A	6063	T6	LH0089921	X85555				
窗玉	框橫料扣蓋	12	A01	6063	T5	LH0089922	X85556				
窗玉	生玉料(單玻)	13	A02	6063	T6	LH0089923	X85557				
窗玉	玻璃扣蓋	14	A03	6063	T6	LH0089924	X85558				
窗玉	生玉料(雙玻)	15	A04	6063	T6	LH0089925	X85559	1			
窗玉	單玻插線	16	A05	6063	T6	LH0089926	X85560				
窗玉	生梗企單玻	17	A06	6063	T6	LH0089927	X85561				
窗玉	生梗企雙玻	18	A07	6063	T6	LH0089928	X85562				
窗玉	生梗企單玻扣蓋	19	A08	6063	T5	LH0089929	X85563	1			
窗玉	生梗企雙玻扣蓋	20	A09	6063	T5	LH0089930	X85564	1			
套心	雙梗企套心	21	A10	6061	T6	LH0089931	X85565				
套心	生梗企套心	22	A11	6061	T6	LH0089932	X85566				
套心	雙生企套心	23	A12	6061	T6	LH0089933	X85567				
套心	轉角企套心	24	A13	6061	T6	LH0090005	X85568				
企橫	轉角外蓋	25	A14	6063	T6	LH0089934	X85569				
取消	SD平台橫料(單玻)	26	S01	6063	T6	LH0089935	X85570				
趟門	SD梗框企收邊	27	S02	6063	T5	LH0090014	X85571		1		
趟門	SD平台橫料(雙玻)	28	S03	6063	T6	LH0089936	X85572		1		
取消	SD梗框底(單玻)	29	S04	6063	T6		X85573				
趟門	SD梗框底(雙玻)	30	S05	6063	T6	LH0090103	X85574		1		
取消	SD梗企扣料(單玻)	31	S06	6063	T6		X85575				
趟門	SD梗企扣角線	32	S07	6063	T6	LH0090104	X85576				
趟門	SD梗企扣料(雙玻)	33	S08	6063	T6	LH0090105	X85577				
趟門	SD平台橫扣蓋	34	S09	6063	T5	LH0089937	X85578				
趟門	SD中柱底座	35	S10	6063	T6	LH0090106	X85579				
趟門	SD中柱勾企	36	S12	6063	T6	LH0090107	X85580		1		
趟門	SD框頂橫	37	S13	6063	T6	LH0090118	X85581		1		
趟門	SD勾企料	38	S15	6063	T6	LH0090119	X85582		1		
趟門	SD玉底橫	39	S16	6063	T6	LH0090120	X85583		1		
趟門	SD框底橫	40	S17	6063	T5	LH0090108	X85584		1		
趟門	SD玉頂橫	41	S18	6063	T6	LH0090121	X85585		1		
趟門	SD中柱扣蓋	42	S19	6063	T6	LH0090109	X85586				
FD門	FD門框底	43	F01	6063	T6		X85587				
FD門	FD門框頂	44	F02	6063	T6		X85588				
FD門	FD框企料	45	F03	6063	T5		X85589				
FD門	FD門玉料	46	F04	6063	T6		X85590				
FD門	FD門	47	F05	6063	T6		X85591				
鋁碼	固定鋁碼	48	AB01	6061	T6	LH0089938	X85592				
介子	85介子	49	AB2	6061	T6	LH0089939	X85593				
企橫	30*30*6鋁角	50	AB4	6061	T6	LH0089940	X85594				
取消	室外收口壓巴	51	AB5	6063	T5	LH0089941	X85595				
企橫	轉角企內企	52	A15	6063	T6	LH0090006	X85596				
企橫	轉角企室內蓋	53	A16	6063	T5	LH0090007	X85597				
窗玉	拉巴	54	A17	6063	T6	LH0090013	X85598	1			
窗玉	6+6玻璃用窗玉	55	A18	6063	T6	LH0090015	X85599				
介子	48介子	56	AB6	6061	T6	LH0090080	X85600				
趟門	中柱扣蓋(短)	57	S20	6063	T6	LH0090110	X85603				
趟門	趟門玉加拉手	58	S21	6063	T6	LH0090122	X85608		1		
趟門	趟門企框摩耳	59	S22	6063	T6	LH0090111	X85604		1		
取消	雙梗橫料	60	T1A	6063	T6		X85605				
趟門	玻璃拍線	61	S23	6063	T6	LH0090170	X85621		1		
趟門	底路軌飾線	62	S24	6063	T6	LH0090171	X85622		1		
趟門	底路軌(泥水用)	63	S25	6063	T6	LH0090172	X85623		1		
趟門	頂橫(泥水用)	64	S26	6063	T6	LH0090173	X85624		1		
背板	修背板位用	65	AB7	6063	T5	LH0090174	X85625		1		
趟門	SD梗企扣角線	66	S07	6063	T6		X85626				
趟門	SD梗企扣料(雙玻)	67	S08	6063	T6		X85627				
						總數	3	1	16		

CUSTOMER	HONGKONG CO.	CUSTOMER APPROVAL	CUST PART NO.	X85571
			SECTION NO.	LH0090014

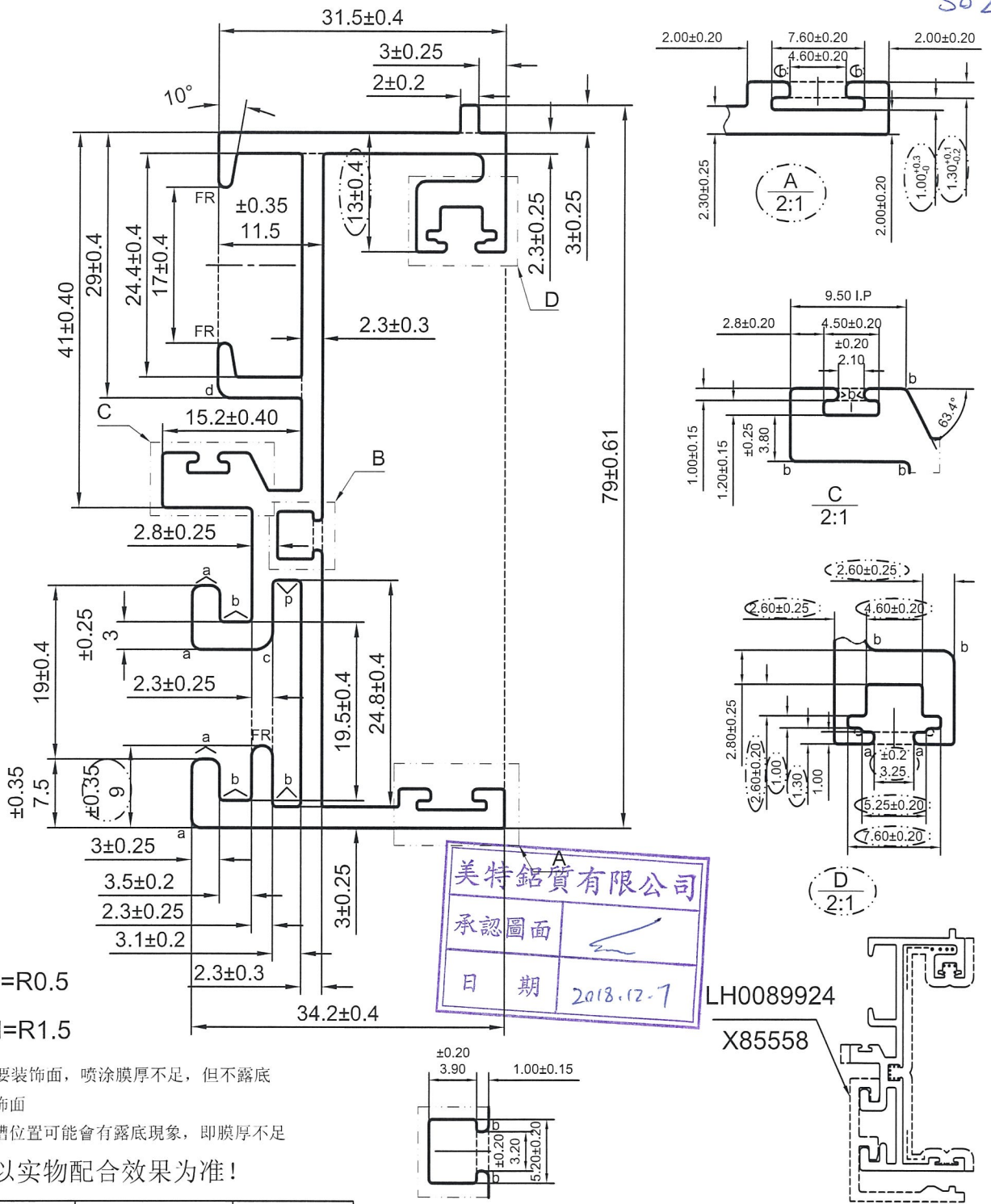

a=R1 b=R0.5
c=R2 d=R1.5

- 次要装饰面，喷涂膜厚不足，但不露底
 - 装饰面
 - 凹槽位置可能会有露底现象，即膜厚不足
- *配合尺寸以实物配合效果为准！

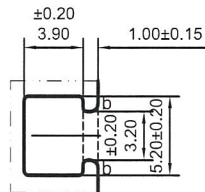

SIGNATURE GRADEING	HIGH SIGNATURE GRADEING	C.C.DIA(MM)	Ø84.62	SCALE 1:2 V.F					
AREA (SQ MM)	586.20	UNSPECIFIED THICKNESS	2.3±0.25	PERIMETER (MM)	486.44	STANDARD	BS EN755	SCALE	1.5:1
MASS (KG/M)	1.59	UNSPECIFIED CORNERS	R 0.3	SURFACE AREA	199.16	ALLOY	6063-T6	VERSION	C
		DRAWN	蔡晓婷	DATE	2018-12-04	APELLATION	-	PAGE 1 OF 2	
		STANDARDIZATION		DATE					
		TO SIGN	陈国提	DATE					
		AUDITING		DATE					
MARKER	MODIFY	FILE NO	SIGNATURE	DATE	APPROV				

CUSTOMER	HONGKONG CO.	CUSTOMER APPROVAL		CUST PART NO.	X85572
				SECTION NO.	LH0089936

So 3

美特鋁質有限公司	
承認圖面	MP
日期	2018.12.7

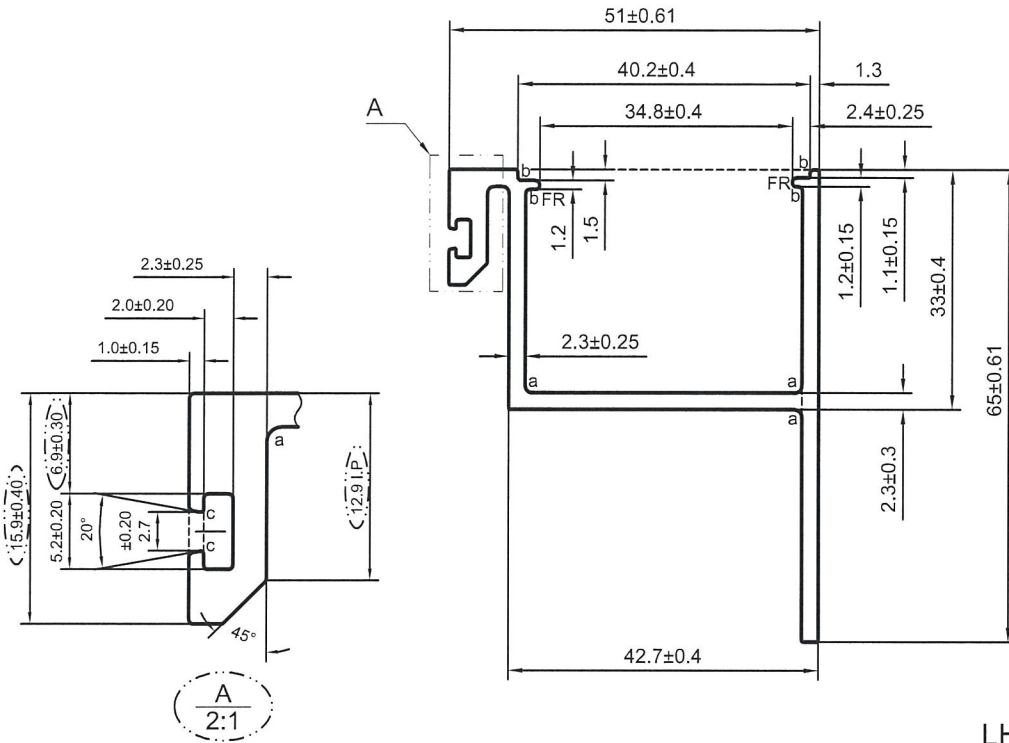

LH0089937

X85578

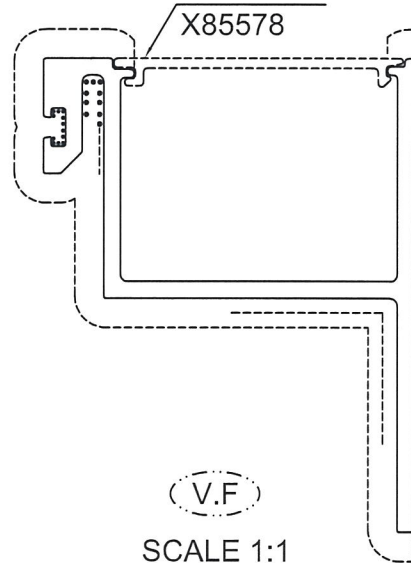

a=R1 b=R0.5 c=R0.2

- 次要装饰面，喷涂膜厚不足，但不露底
- 装饰面
- 凹槽位置可能会有露底现象，即膜厚不足

*配合尺寸以实物配合效果为准！

SIGNATURE GRADEING	HIGH SIGNATURE GRADEING	C.C.DIA(MM)	Ø82.38						
AREA (SQ MM)	388.39	UNSPECIFIED THICKNESS	2.3±0.25	PERIMETER (MM)	330.27	STANDARD	BS EN755	SCALE	1:1
MASS (KG/M)	1.053	UNSPECIFIED CORNERS	R 0.3	SURFACE AREA	170.71	ALLOY	6063-T6	VERSION	C
			DRAWN	蔡晓婷	DATE	2018-10-25	APELLATION	PAGE OF	
			STANDARDIZATION		DATE				
			TO SIGN	陈国提	DATE				
			AUDITING		DATE				
MARKER	MODIFY	FILE NO	SIGNATURE	DATE	APPROV	DATE			

 PANASIA ALUMINUM (CHINA) LIMITED

CUSTOMER	HONGKONG CO.	CUSTOMER APPROVAL	CUST PART NO.	X85574
			SECTION NO.	LH0090103

S05

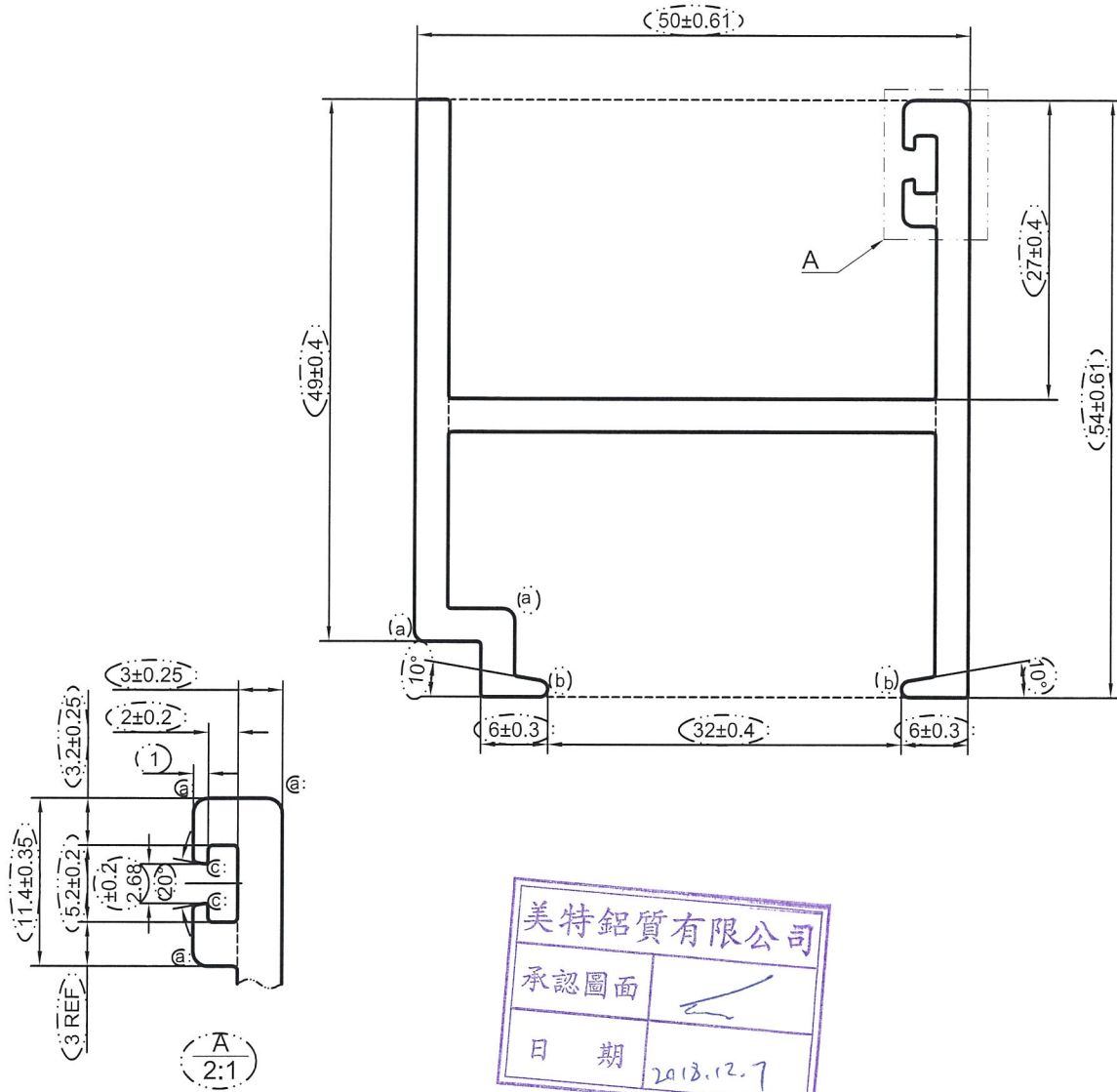

美特鋁質有限公司
承認圖面
日期 2018.12.7

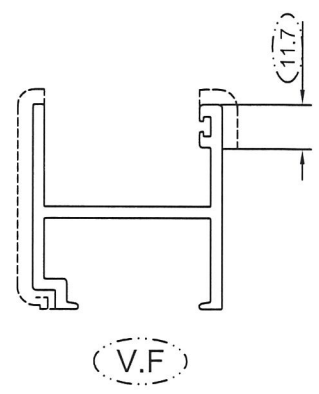

a=R1 (b=R0.75) (c=R0.2)

----- 次要裝飾面，噴塗膜厚不足，但不露底
----- 裝飾面

备注：没有配合型号！

SCALE 1:2

SIGNATURE GRADEING	HIGH SIGNATURE GRADEING	C.C.DIA(MM)	Ø 73.35						
AREA (SQ MM)	503.53	UNSPECIFIED THICKNESS	3±0.25	PERIMETER (MM)	344.19	STANDARD	BS EN755	SCALE	1.5:1
MASS (KG/M)	1.36	UNSPECIFIED CORNERS	R 0.3	SURFACE AREA	80.50	ALLOY	6063-T6	VERSION	B
			DRAWN	陈晓舒	DATE	2018-12-03	APPELLATION	-	PAGE OF
			STANDARDIZATION		DATE				
			TO SIGN	陈国提	DATE				
			AUDITING		DATE				
MARKER	MODIFY	FILE NO	SIGNATURE	DATE	APPROV				

 PANASIA ALUMINUM (CHINA) LIMITED

CUSTOMER	HONGKONG CO.	CUSTOMER APPROVAL	CUST PART NO.	X85580
			SECTION NO.	LH0090107

S12

美特鋁質有限公司	
承認圖面	
日期	2018.12.7

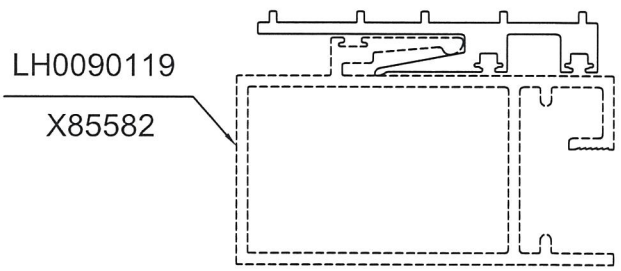
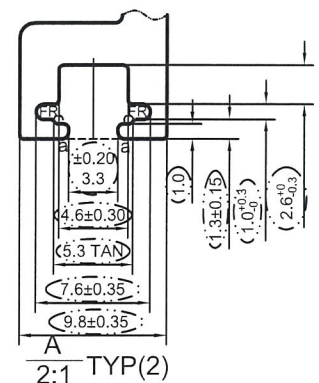
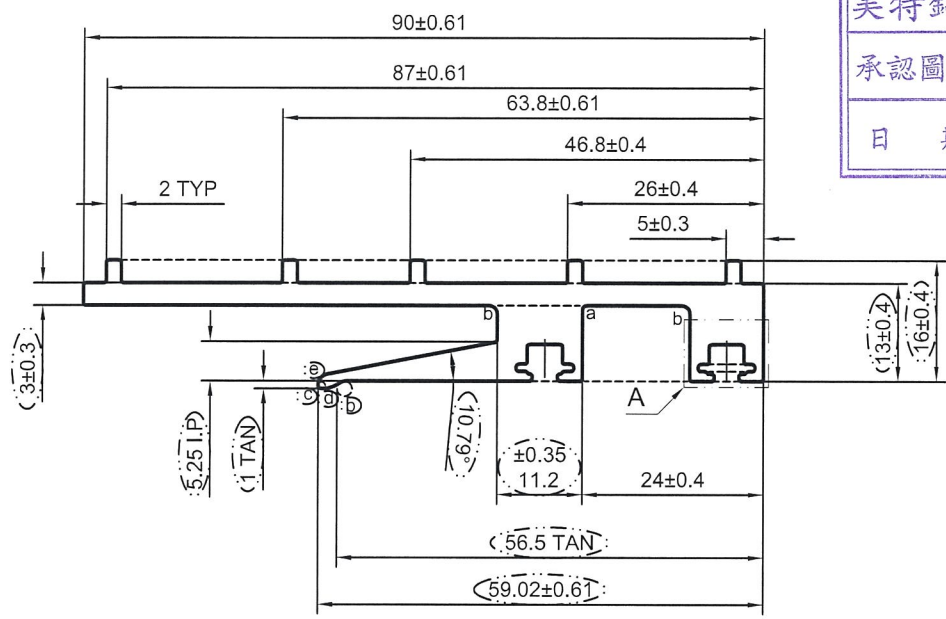

SCALE 1:2

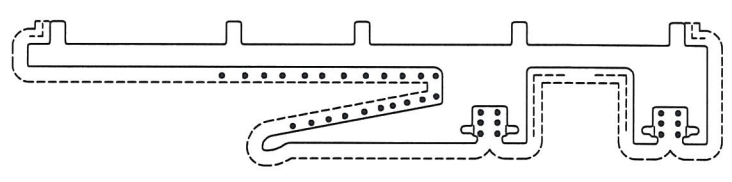

(V.F)
SCALE 1:1

a=R0.5 b=R1 (C=R0.2)
(d=R2.1) (e=R0.7)

- 次要装饰面, 喷涂膜厚不足, 但不露底
- 装饰面
- 凹槽位置可能会有露底现象, 即膜厚不足

*配合尺寸以实物配合效果为准!

SIGNATURE GRADEING	HIGH SIGNATURE GRADEING	C.C.DIA(MM)	Ø(90.86)						
AREA (SQ MM)	534.8 (536.09)	UNSPECIFIED THICKNESS	3±0.25	PERIMETER (MM)	327.7	STANDARD	BS EN755	SCALE	1:1
MASS (KG/M)	(1.452)	UNSPECIFIED CORNERS	R 0.3	SURFACE AREA	222.33	ALLOY	6063-T6	VERSION	C
				DRAWN	陈晓舒	DATE	2018-12-03	APPELLATION	-
				STANDARDIZATION		DATE		PAGE OF	
				TO SIGN	陈国提	DATE			
				AUDITING		DATE			
MARKER	MODIFY	FILE NO	SIGNATURE	DATE	APPROV		DATE		

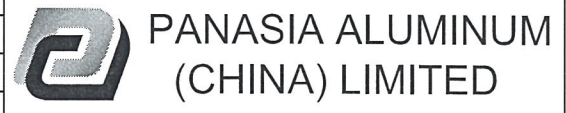

CUSTOMER	HONGKONG CO.	CUSTOMER APPROVAL	CUST PART NO.	X85582
			SECTION NO.	LH0090119

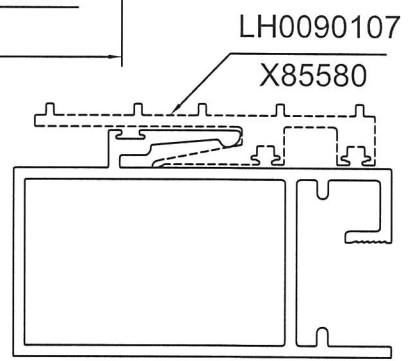
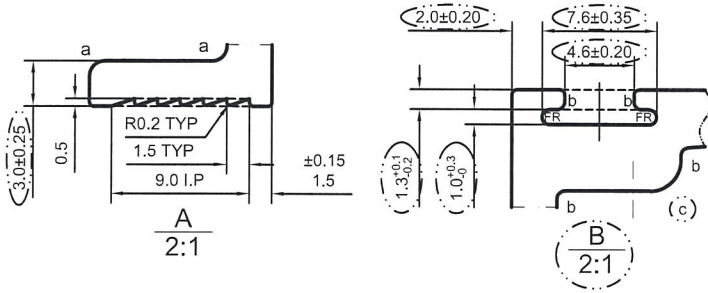
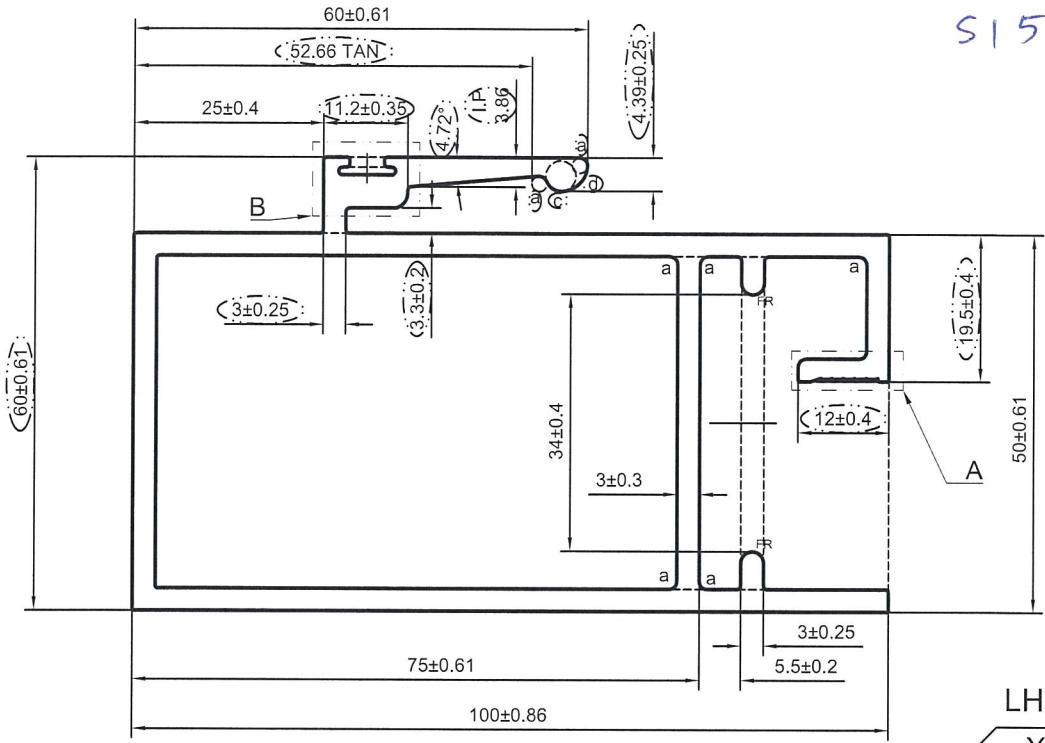

a=R1 b=R0.5 (c=R2) (d=R3.5)

----- 次要装饰面, 喷涂膜厚不足, 但不露底
 - - - - - 装饰面

●●●●● 凹槽位置可能会有露底现象, 即膜厚不足

*配合尺寸以实物配合效果为准!

美特铝质有限公司
 承認圖面
 日期 2018-12-7

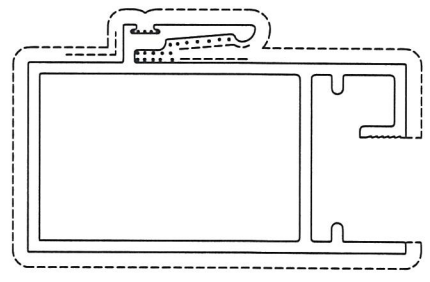

(V.F)
 SCALE 1:2

SIGNATURE GRADEING	HIGH SIGNATURE GRADEING	C.C.DIA(MM)	Ø111.6	AREA (SQ MM)	(115.45)	UNSPECIFIED THICKNESS	3±0.25	PERIMETER (MM)	(507.70)	STANDARD	BS EN755	SCALE	1:1
MASS (KG/M)	(3.022)	UNSPECIFIED CORNERS	R 0.3	SURFACE AREA	(363.06)	ALLOY	6063-T6	VERSION	B				
-		-		DRAWN	陈晓舒	DATE	2018-12-04	APELLATION	-	PAGE OF			
				STANDARDIZATION		DATE							
				TO SIGN	陈国提	DATE							
				AUDITING		DATE							
MARKER	MODIFY	FILE NO	SIGNATURE	DATE	APPROV		DATE						

CUSTOMER	HONGKONG CO.	CUSTOMER APPROVAL	CUST PART NO.	X85583
			SECTION NO.	LH0090120

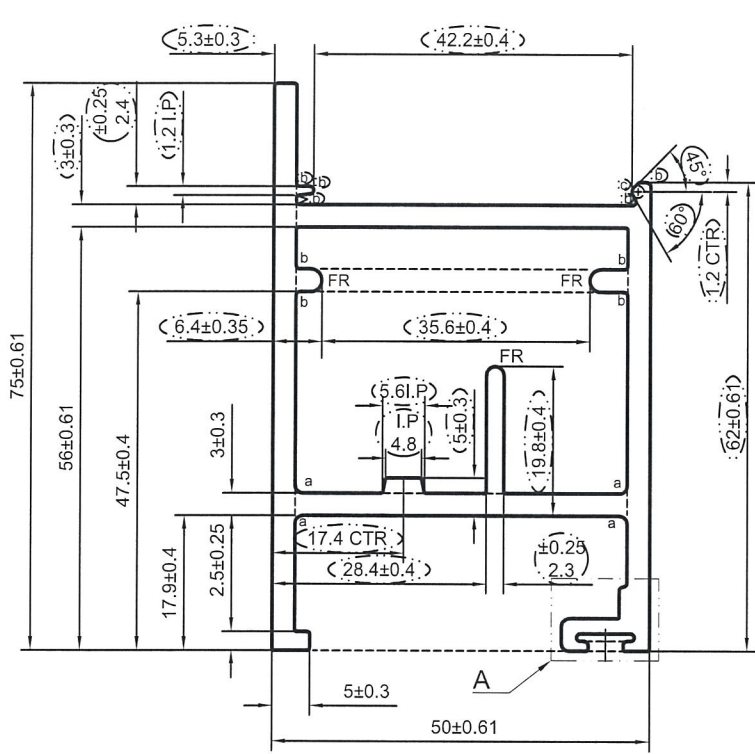

S16

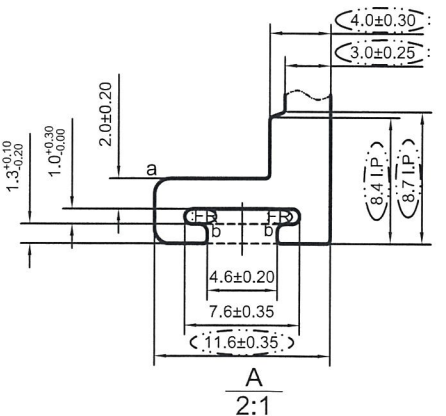

LH0090170
X85621

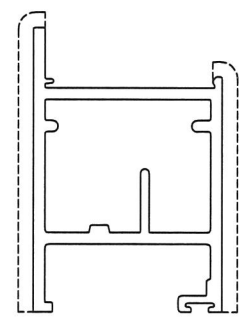
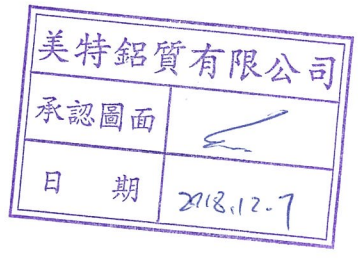
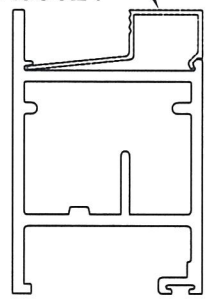

(V.F)

SCALE 1:2

a=R1 b=R0.5 (c=R0.8)

----- 次要装饰面，喷涂膜厚不足，但不露底
 ----- 装饰面

*配合尺寸以实物配合效果为准！

SIGNATURE GRADEING	HIGH SIGNATURE GRADEING	C.C.DIA(MM)	Ø89.91							
AREA (SQ MM)	(780.18)	UNSPECIFIED THICKNESS	3±0.25	PERIMETER (MM)	(321.93)	STANDARD	BS EN755	SCALE	1:1	
MASS (KG/M)	(2.114)	UNSPECIFIED CORNERS	R 0.3	SURFACE AREA	(143.73)	ALLOY	6063-T6	VERSION	B	
-			DRAWN	陈晓舒	DATE	2018-12-04	APPELLATION	-		
			STANDARDIZATION		DATE					
			TO SIGN	陈国提	DATE					
			AUDITING		DATE					
MARKER	MODIFY	FILE NO	SIGNATURE	DATE	APPROV					



CUSTOMER	HONGKONG CO.	CUSTOMER APPROVAL	CUST PART NO.	X85584
			SECTION NO.	LH0090108

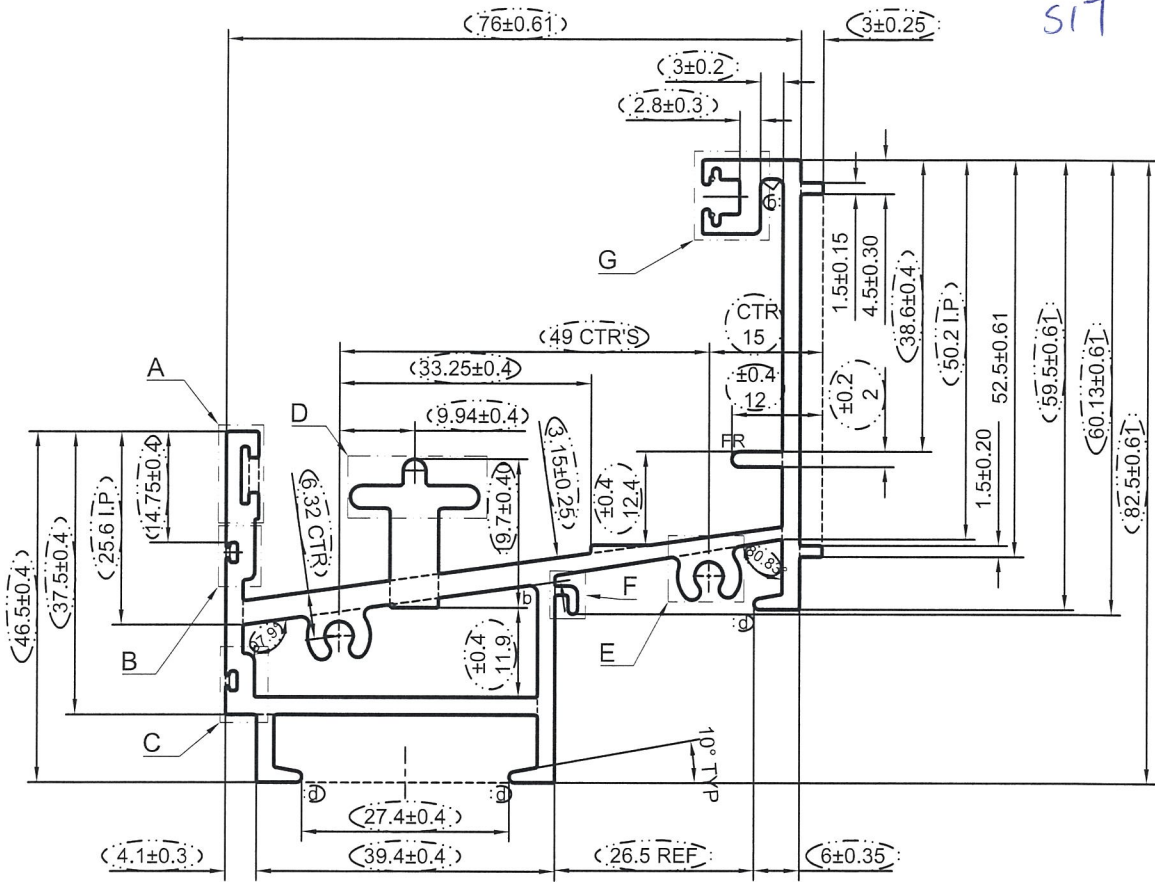

美特鋁質有限公司
承認圖面
日期 2018.12.7

a=R0.5 b=R1

c=R0.2

d=R0.75

LH0090171

X85622

- 次要裝飾面，噴塗膜厚不足，但不露底
- 裝飾面
- 凹槽位置可能會有露底現象，即膜厚不足

*配合尺寸以实物配合效果为准！

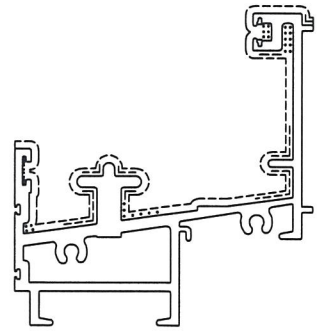
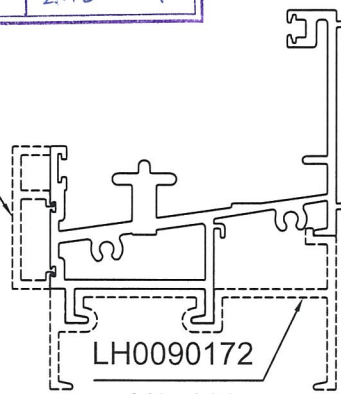

SIGNATURE GRADEING	HIGH SIGNATURE GRADEING	C.C.DIA(MM)	Ø(116.61)						
AREA (SQ MM)	908.71 (909.35)	UNSPECIFIED THICKNESS	2.3±0.2	PERIMETER (MM)	574.72	STANDARD	BS EN755	SCALE	1:1
MASS (KG/M)	2.464	UNSPECIFIED CORNERS	R 0.3	SURFACE AREA	277.10	ALLOY	6063-T6	VERSION	C
			DRAWN	陈晓舒	DATE	2018-12-04	APPELLATION	-	
			STANDARDIZATION		DATE		PAGE 1 OF 2		
			TO SIGN	陈国提	DATE				
			AUDITING		DATE				
MARKER	MODIFY	FILE NO	SIGNATURE	DATE	APPROV	DATE			

CUSTOMER	HONGKONG CO.	CUSTOMER APPROVAL	CUST PART NO.	X85584
			SECTION NO.	LH0090108

517

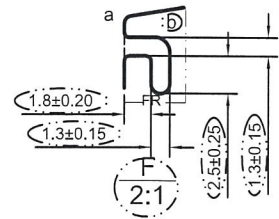
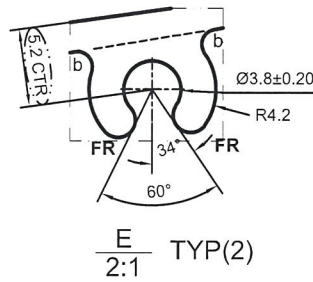
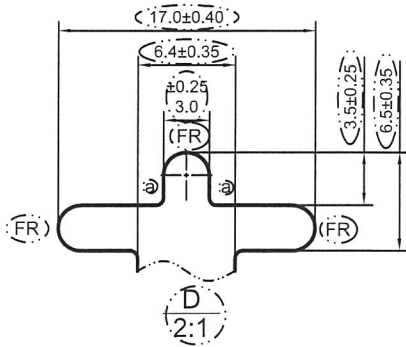
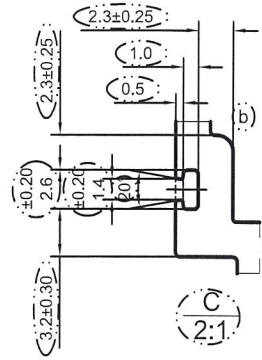
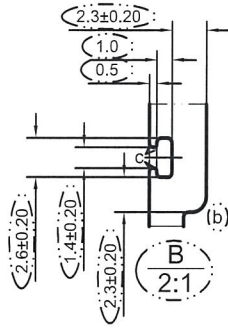
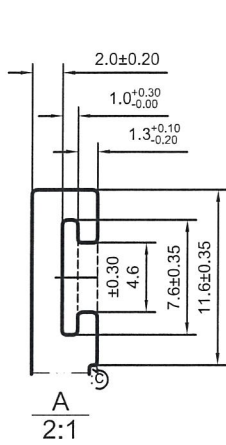

美特鋁質有限公司
承認圖面
日期 2018.12.7

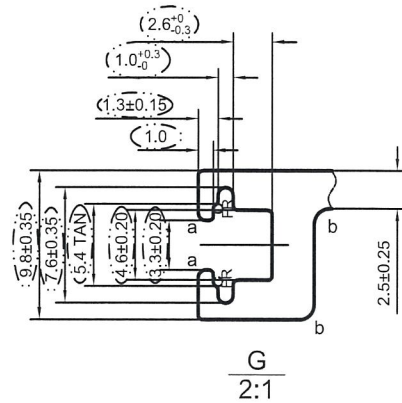

SIGNATURE GRADEING	HIGH SIGNATURE GRADEING	C.C.DIA(MM)	Ø(116.6)						
AREA (SQ MM)	908.71 (909.35)	UNSPECIFIED THICKNESS	2.3±0.2	PERIMETER (MM)	574.72	STANDARD	BS EN755	SCALE	1:1
MASS (KG/M)	2.464	UNSPECIFIED CORNERS	R 0.3	SURFACE AREA	277.10	ALLOY	6063-T6	VERSION	C
			DRAWN	陈晓舒	DATE	2018-12-04	APPELLATION	-	
			STANDARDIZATION		DATE				
			TO SIGN	陈国提	DATE				
			AUDITING		DATE				
MARKER	MODIFY	FILE NO	SIGNATURE	DATE	APPROV	DATE			

CUSTOMER	HONGKONG CO.	CUSTOMER APPROVAL	CUST PART NO.	X85585
			SECTION NO.	LH0090121

518

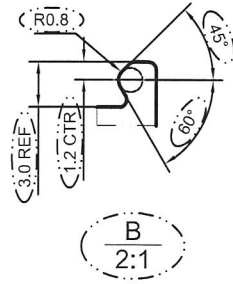
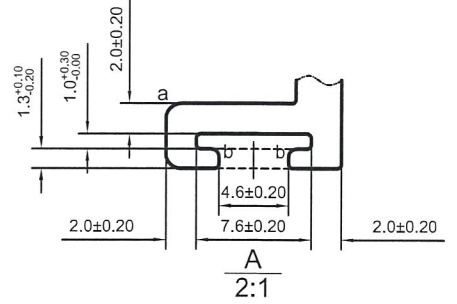
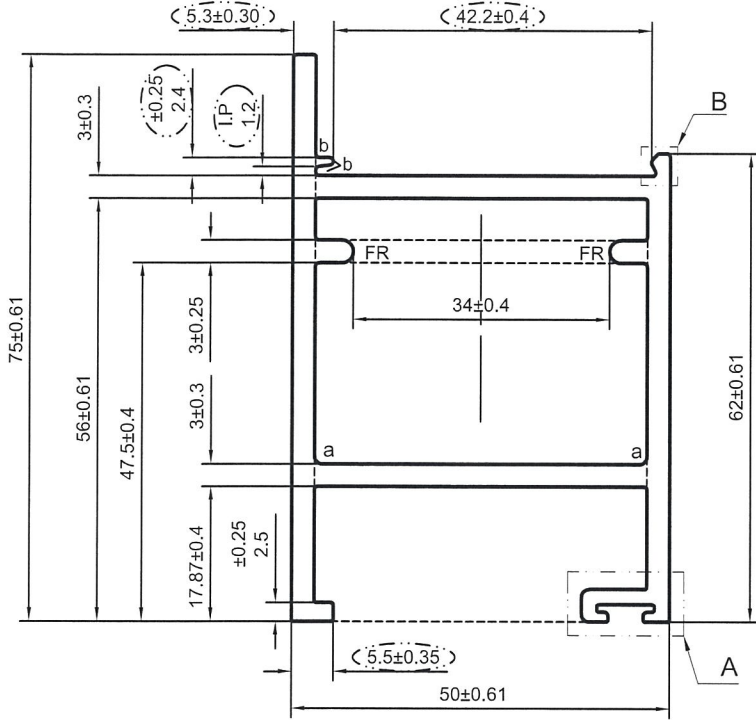

美特鋁質有限公司
承認圖面
日期 2018.12.1

LH0090170
X85621

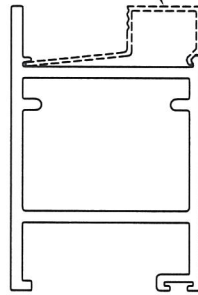

SCALE 1:2

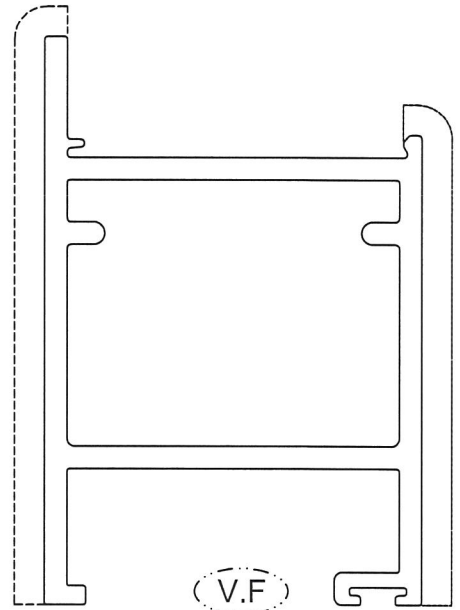

SCALE 1:1

a=R1 b=R0.5

*配合尺寸以实物配合效果为准!

SIGNATURE GRADEING	HIGH SIGNATURE GRADEING	C.C.DIA(MM)	Ø89.91						
AREA (SQ MM)	732.87	UNSPECIFIED THICKNESS	3±0.25	PERIMETER (MM)	324.28	STANDARD	BS EN755	SCALE	1:1
MASS (KG/M)	1.986	UNSPECIFIED CORNERS	R 0.3	SURFACE AREA	143.73	ALLOY	6063-T6	VERSION	B
-	-	DRAWN	蔡晓婷	DATE	2018-12-03	APPELLATION	-	PAGE OF	
		STANDARDIZATION		DATE					
		TO SIGN	陈国提	DATE					
		AUDITING		DATE					
MARKER	MODIFY	FILE NO	SIGNATURE	DATE	APPROV				

CUSTOMER	HONGKONG CO.	CUSTOMER APPROVAL	CUST PART NO.	X85604
			SECTION NO.	LH0090111

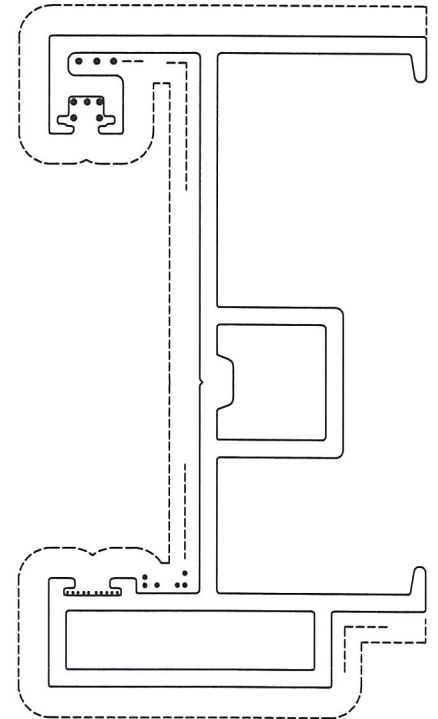
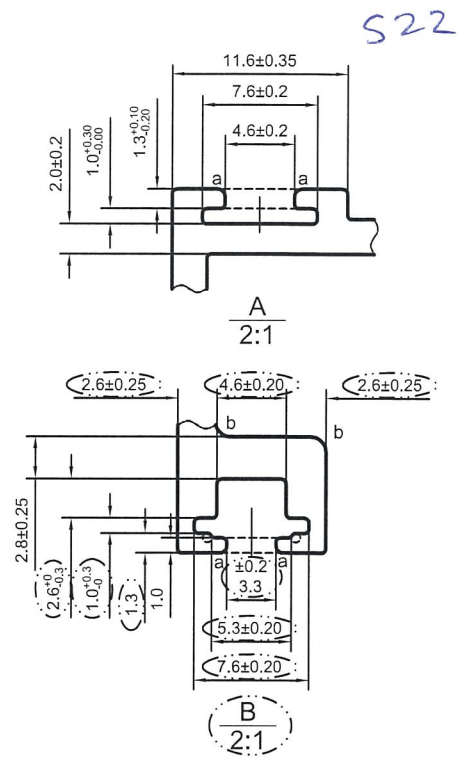
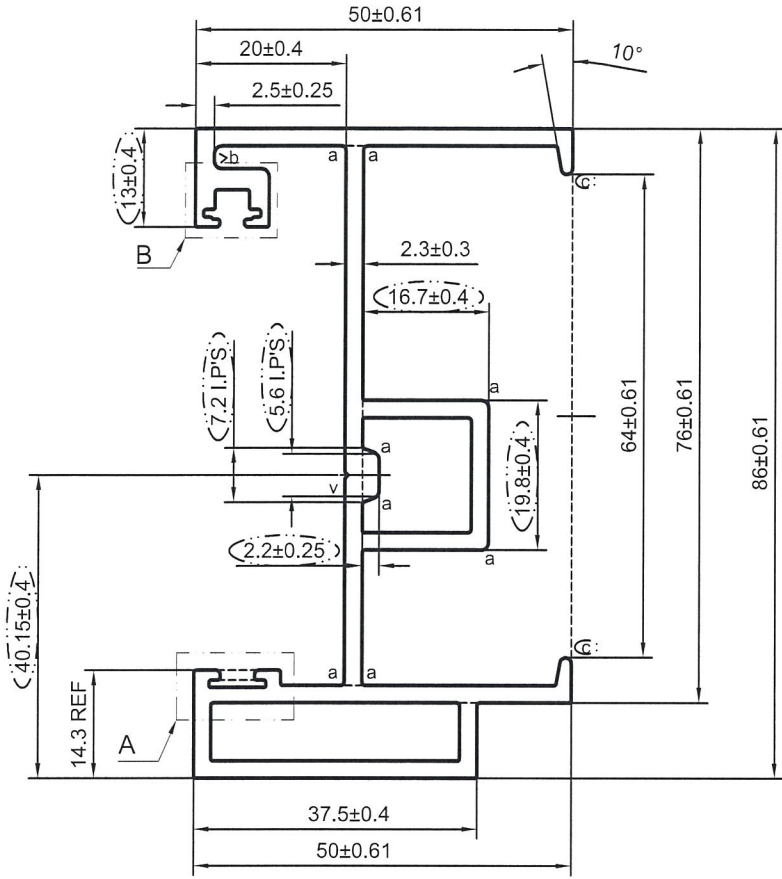

美特鋁質有限公司

承認圖面	✓
日期	2018.12.7

$\langle v=0.4 \times 90^\circ \rangle$

a=R0.5 b=R1 c=R0.75

----- 次要裝飾面，噴塗膜厚不足，但不露底

----- 裝飾面

●●●●●● 凹槽位置可能有露底現象，即膜厚不足

备注：没有配合型号！

V.F
SCALE 1:1

SIGNATURE GRADEING	HIGH SIGNATURE GRADEING	C.C.DIA(MM)	Ø 99.26	PERIMETER (MM)	474.56	STANDARD	BS EN755	SCALE	1:1
AREA (SQ MM)	721.90 (722.55)	UNSPECIFIED THICKNESS	2.3±0.25	SURFACE AREA	299.54	ALLOY	6063-T6	VERSION	C
MASS (KG/M)	1.96	UNSPECIFIED CORNERS	R 0.3	DRAWN 蔡晓婷 DATE 2018-12-04		APPELLATION -		PAGE OF	
		STANDARDIZATION		DATE					
		TO SIGN	陈国提	DATE					
		AUDITING		DATE					
MARKER	MODIFY	FILE NO	SIGNATURE	DATE	APPROV				

CUSTOMER	HONGKONG CO.	CUSTOMER APPROVAL	CUST PART NO.	X85621
			SECTION NO.	LH0090170

S23

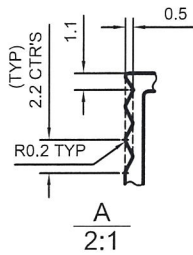
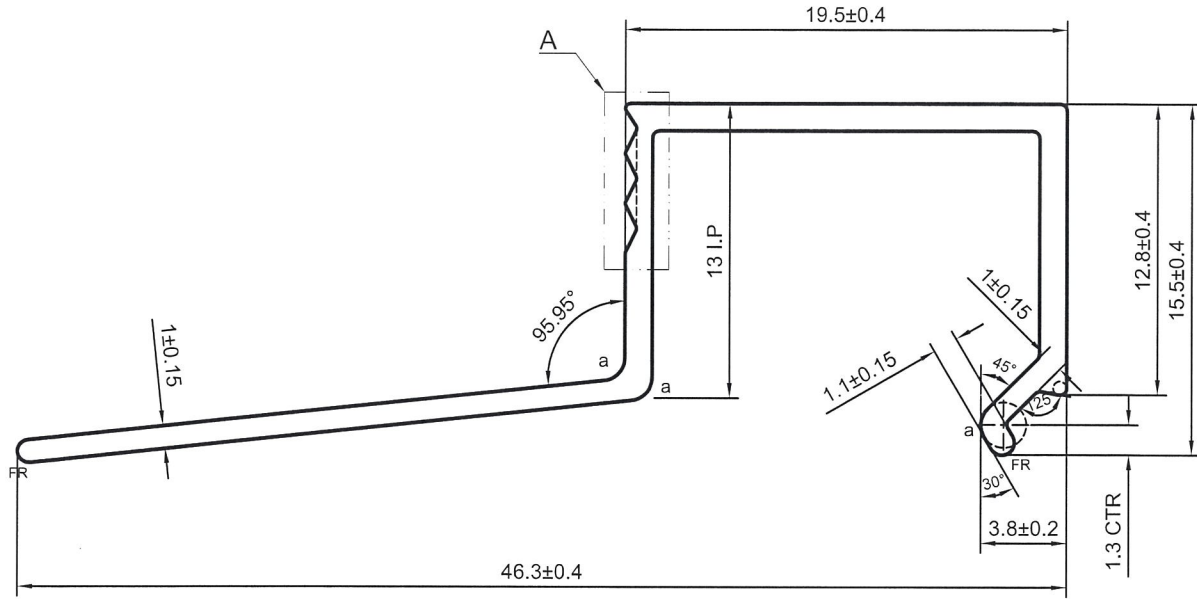

LH0090120
X85583

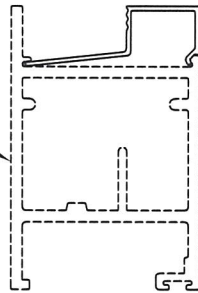

LH0090121
X85585

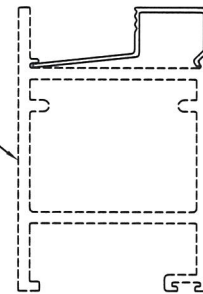

SCALE 1:2

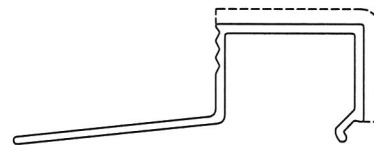
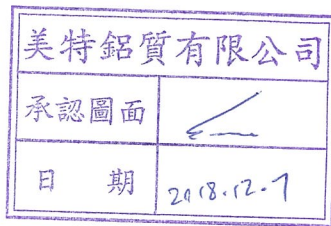

V.F

SCALE 1:1

a=R1

*配合尺寸以实物配合效果为准!

SIGNATURE GRADEING	HIGH SIGNATURE GRADEING	C.C.DIA(MM)	Ø48.8							
AREA (SQ MM)	81.25	UNSPECIFIED THICKNESS	1.2±0.15	PERIMETER (MM)	150	STANDARD	BS EN755	SCALE	3:1	
MASS (KG/M)	0.220	UNSPECIFIED CORNERS	R 0.3	SURFACE AREA	32.61	ALLOY	6063-T6	VERSION	A	
-		-		DRAWN	陈晓舒	DATE	2018-12-05	APPELLATION	-	PAGE OF
				STANDARDIZATION		DATE		 PANASIA ALUMINUM (CHINA) LIMITED		
				TO SIGN	陈国提	DATE				
				AUDITING		DATE				
MARKER	MODIFY	FILE NO	SIGNATURE	DATE	APPROV		DATE			

CUSTOMER	HONGKONG CO.	CUSTOMER APPROVAL	CUST PART NO.	X85622
			SECTION NO.	LH0090171

S24

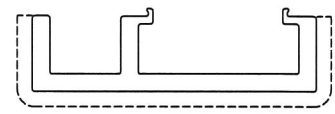
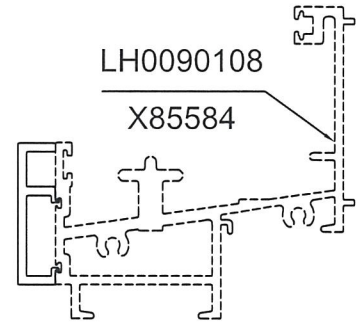
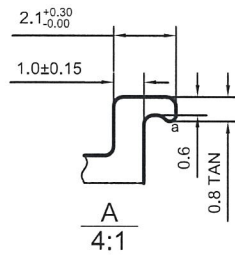
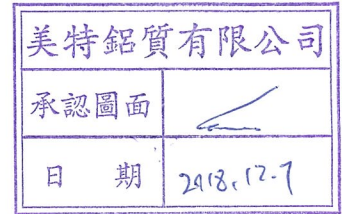
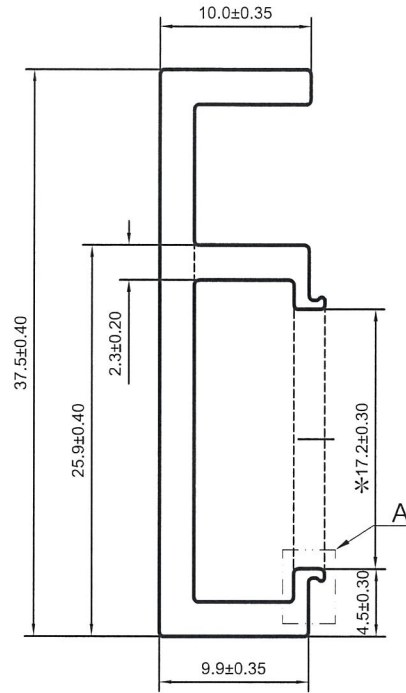

a=R0.2

*配合尺寸以实物配合效果为准!

V.F
SCALE 1:1

SIGNATURE GRADEING	HIGH SIGNATURE GRADEING	C.C.DIA(MM)	Ø38.68							
AREA (SQ MM)	144.4 (144.57)	UNSPECIFIED THICKNESS	2.3±0.2	PERIMETER (MM)	135.86	STANDARD	BS EN755	SCALE	2:1	
MASS (KG/M)	0.392	UNSPECIFIED CORNERS	R 0.3	SURFACE AREA	57.5	ALLOY	6063-T6	VERSION	A	
-		-		DRAWN	陈晓舒	DATE	2018-12-05	APPELLATION	-	PAGE OF
				STANDARDIZATION		DATE				
				TO SIGN	陈国提	DATE				
				AUDITING		DATE				
MARKER	MODIFY	FILE NO	SIGNATURE	DATE	APPROV		DATE			

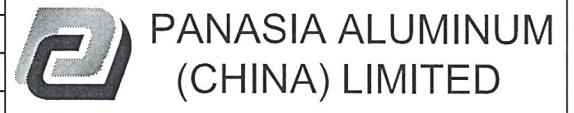

CUSTOMER	HONGKONG CO.	CUSTOMER APPROVAL	CUST PART NO.	X85623
			SECTION NO.	LH0090172

S25

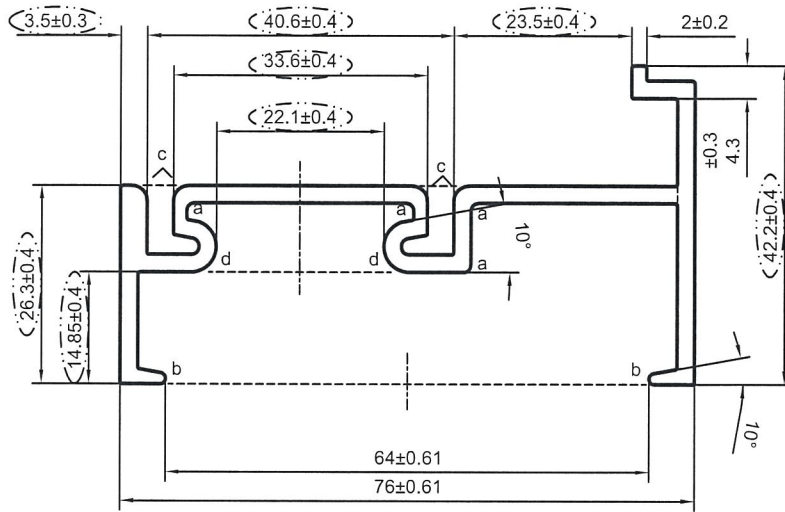

LH0090108
X85584

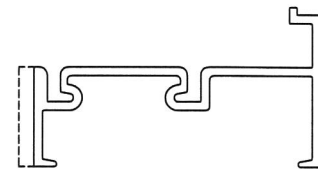
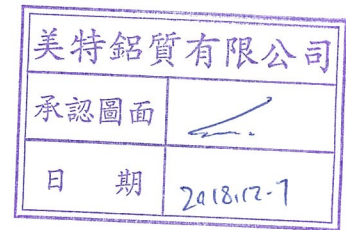
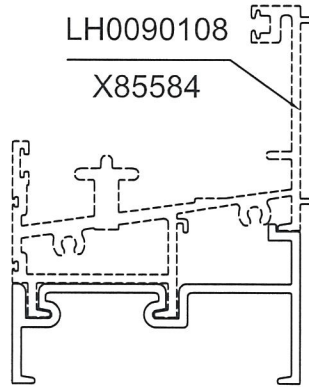

V.F

SCALE 1:2

a=R1 b=R0.75

c=R2 d=R3.4

*配合尺寸以实物配合效果为准!

SIGNATURE GRADEING	HIGH SIGNATURE GRADEING	C.C.DIA(MM)	Ø85.91						
AREA (SQ MM)	438.19	UNSPECIFIED THICKNESS	2.3±0.2	PERIMETER (MM)	377.43	STANDARD	BS EN755	SCALE	1:1
MASS (KG/M)	1.188	UNSPECIFIED CORNERS	R 0.3	SURFACE AREA	26.64	ALLOY	6063-T6	VERSION	A
		DRAWN	陈晓舒	DATE	2018-12-05	APPELLATION			
		STANDARDIZATION		DATE					
		TO SIGN	陈国提	DATE					
		AUDITING		DATE					
MARKER	MODIFY	FILE NO	SIGNATURE	DATE	APPROV				



PANASIA ALUMINUM
(CHINA) LIMITED

CUSTOMER	HONGKONG CO.	CUSTOMER APPROVAL	CUST PART NO.	X85624
			SECTION NO.	LH0090173

526

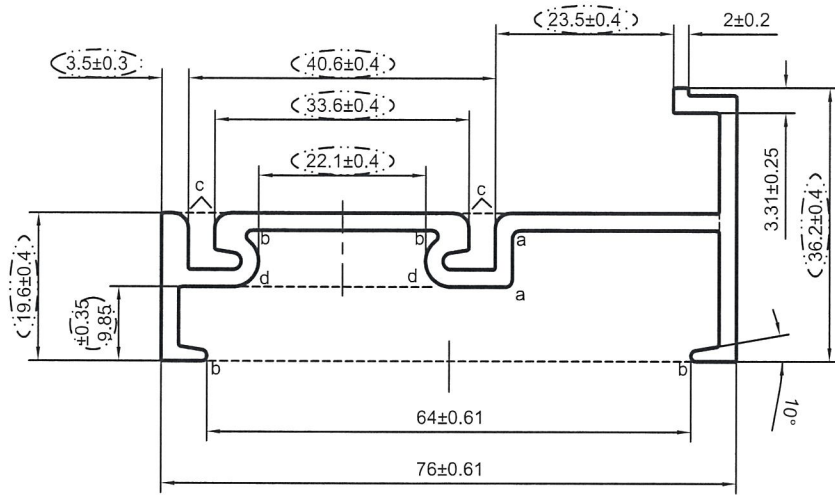

美特鋁質有限公司
承認圖面
日期 2018.12.7

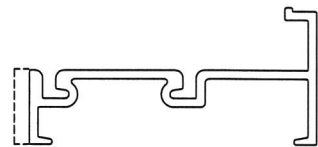
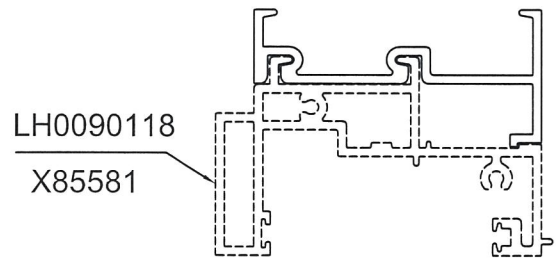

V.F
SCALE 1:2

a=R1 b=R0.75
c=R2 d=R3.4

*配合尺寸以实物配合效果为准!

SIGNATURE GRADEING	HIGH SIGNATURE GRADEING	C.C.DIA(MM)	Ø83.68						
AREA (SQ MM)	400.47	UNSPECIFIED THICKNESS	2.3±0.2	PERIMETER (MM)	333.89	STANDARD	BS EN755	SCALE	1:1
MASS (KG/M)	1.09	UNSPECIFIED CORNERS	R 0.3	SURFACE AREA	19.94	ALLOY	6063-T6	VERSION	A
		DRAWN	陈晓舒	DATE	2018-12-05	APPELLATION	-	PAGE OF	
		STANDARDIZATION		DATE					
		TO SIGN	陈国提	DATE					
		AUDITING		DATE					
MARKER	MODIFY	FILE NO	SIGNATURE	DATE	APPROV				

CUSTOMER	HONGKONG CO.	CUSTOMER APPROVAL	CUST PART NO.	X85625
			SECTION NO.	LH0090174

AB7

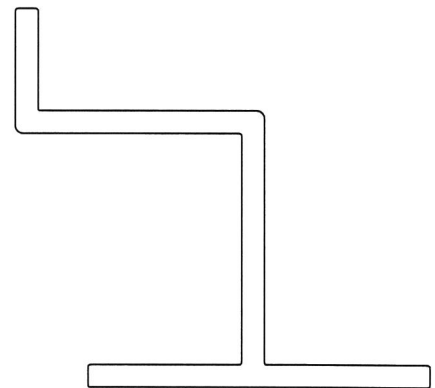
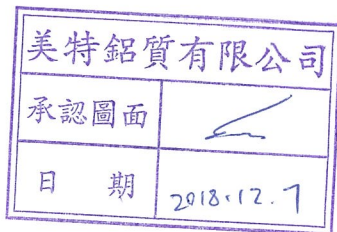
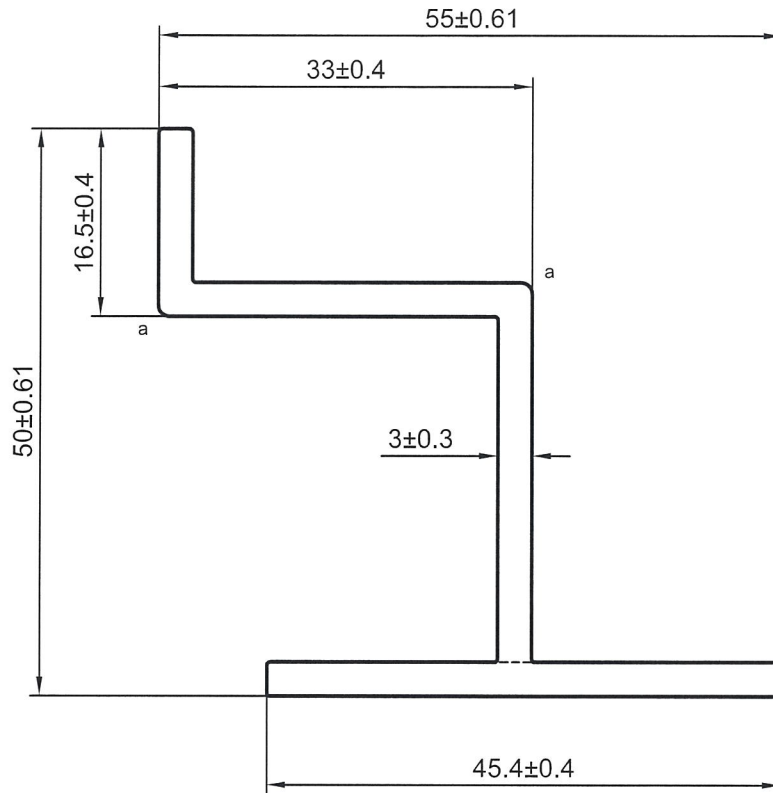

a=R1

备注：没有配合型号！

NO V.F
SCALE 1:1

SIGNATURE GRADEING	HIGH SIGNATURE GRADEING	C.C.DIA(MM)	Ø75.46							
AREA (SQ MM)	366.73	UNSPECIFIED THICKNESS	3±0.25	PERIMETER (MM)	248.65	STANDARD	BS EN755	SCALE	1.5:1	
MASS (KG/M)	0.994	UNSPECIFIED CORNERS	R 0.3	SURFACE AREA	-	ALLOY	6063-T5	VERSION	A	
-		-		DRAWN	陈晓舒	DATE	2018-12-05	APPELLATION	-	PAGE OF
				STANDARDIZATION		DATE				
				TO SIGN	陈国提	DATE				
				AUDITING		DATE				
MARKER	MODIFY	FILE NO	SIGNATURE	DATE	APPROV		DATE			



PANASIA ALUMINUM (CHINA) LIMITED