



工程指示 / 要求簡箋(E.I.)

工程指示編號：EI / 9625 / 18

修改版次：-

工程編號：J - 837

工程名稱：觀塘裕民坊

工程項目：幕牆 鋁料模具生產(15個)

收件人：Maggie / 生統

發件人：Eric Liu

日期：28/08/2018

要求提供 / 確認 事項：

- | | | |
|------------------------------------|-------------------------------------|-------------------------------|
| <input type="checkbox"/> 初步鋁料 B.M. | <input type="checkbox"/> 加工拆圖，然後生產 | <input type="checkbox"/> 尺寸表 |
| <input type="checkbox"/> 正式鋁料 B.M. | <input type="checkbox"/> 技術上資料 / 指示 | <input type="checkbox"/> 報價 |
| <input type="checkbox"/> 配件 B.M. | <input type="checkbox"/> 樣辦或貨品說明書 | <input type="checkbox"/> 分判合約 |
| <input type="checkbox"/> 其他：_____ | | |

內容：

現簽批模具共 15 個，幕牆用新模

謝謝！

請在 2018/09/07 前完成上列要求。

附：15 頁模圖+1 頁

以上項目為：

- 原合約工程包 原合約工程加 / 減賬 新工程報價

原因：-

分發東莞各部門：

- () 生產技術總監 連附件 (/) 技術部 連附件 永林 () 生產部 連附件 () 機械設計部 連附件
 () 採購部 連附件 (/) 生產統籌部 連附件 梅
 (/) 質檢部 連附件 () 會計部 連附件 () 報關組 連附件 () 其他 楊榮輝 連附件

分發其他分判：

- (/) 張 連附件

分發香港各部門：

- () 行政部 連附件 () 會計部 連附件 () 統籌部 連附件 () 工程部地盤科文 連附件
 (/) 採購部 連附件 () QS 部 連附件 () 維修部 連附件 (/) 其他 鄧, 港哥 連附件

傳遞編號：

HK 1343 / 18

發件人簽署：

項目經理簽署：

Page	PART	Grade	榮陽DIE No.	Die No.	0	A	B	C	D
1	M1	6063	T6		X85545				
2	M2	6063	T6		X85546				
3	M3	6063	T6	LH0089914	X85547	1			
4	M4	6063	T6		X85548				
5	M5	6063	T6		X85549				
6	M6	6063	T6	LH0089916	X85550	1			
7	M7	6063	T6		X85551				
8	T1	6063	T6		X85552				
9	T2	6063	T6	LH0089919	X85553	1			
10	T3	6063	T6	LH0089920	X85554	1			
11	T3A	6063	T6	LH0089921	X85555	1			
12	A01	6063	T5	LH0089922	X85556	1			
13	A02	6063	T6		X85557				
14	A03	6063	T6	LH0089924	X85558	1			
15	A04	6063	T6		X85559				
16	A05	6063	T6		X85560				
17	A06	6063	T6		X85561				
18	A07	6063	T6		X85562				
19	A08	6063	T5	LH0089929	X85563	1			
20	A09	6063	T5	LH0089930	X85564	1			
21	A10	6061	T6	LH0089931	X85565	1			
22	A11	6061	T6	LH0089932	X85566	1			
23	A12	6061	T6	LH0089933	X85567	1			
24	A13	6061	T6		X85568				
25	A14	6061	T6		X85569				
26	S01	6063	T6		X85570				
27	S02	6063	T5		X85571				
28	S03	6063	T6		X85572				
29	S04	6063	T6		X85573				
30	S05	6063	T6		X85574				
31	S06	6063	T6		X85575				
32	S07	6063	T6		X85576				
33	S08	6063	T6		X85577				
34	S09	6063	T5	LH0089937	X85578	1			
35	S10	6063	T6		X85579				
36	S12	6063	T6		X85580				
37	S13	6063	T6		X85581				
38	S15	6063	T6		X85582				
39	S16	6063	T6		X85583				
40	S17	6063	T5		X85584				
41	S18	6063	T6		X85585				
42	S19	6063	T6		X85586				
43	F01	6063	T6		X85587				
44	F02	6063	T6		X85588				
45	F03	6063	T5		X85589				
46	F04	6063	T6		X85590				
47	F05	6063	T6		X85591				
48	AB01	6061	T6		X85592				
49	AB2	6061	T6	LH0089939	X85593	1			
50	AB4	6061	T6	LH0089940	X85594	1			
51	AB5	6063	T5		X85595				
						15			

CUSTOMER	HONGKONG CO.	CUSTOMER APPROVAL	CUST PART NO.	X85547
			SECTION NO.	LH0089914

M3

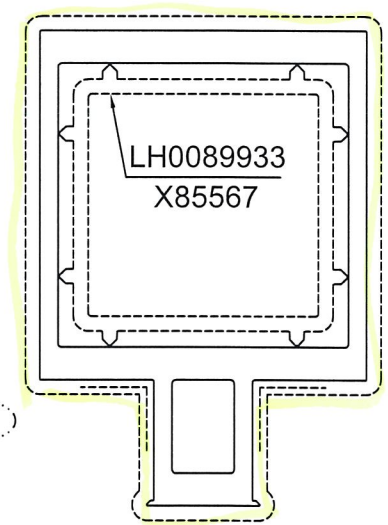
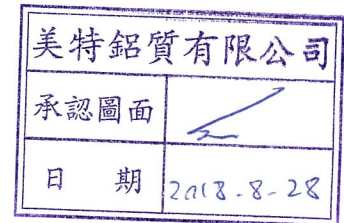
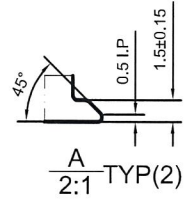
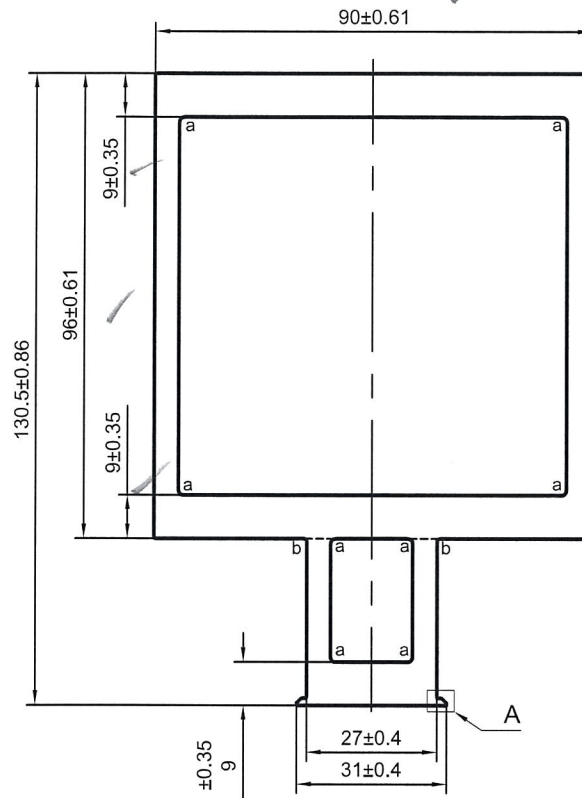

SCALE 1:2

a=R1 b=R0.5

----- 次要装饰面, 喷涂膜厚不足, 但不露底
 - - - - - 装饰面

*配合尺寸以实物配合效果为准!

SIGNATURE GRADEING	HIGH SIGNATURE GRADEING	C.C.DIA(MM)	Ø147.29						
AREA (SQ MM)	2904.74	UNSPECIFIED THICKNESS	5±0.35	PERIMETER (MM)	446.32	STANDARD	GB 5237.1	SCALE	1:1.5
MASS (KG/M)	7.872	UNSPECIFIED CORNERS	R 0.3	SURFACE AREA	446.32	ALLOY	6063-T6	VERSION	A
COMPANY ISSUE		A	DRAWN	蔡晓婷	DATE	2018-08-24	APELLATION	-	PAGE OF
			STANDARDIZATION		DATE				
			TO SIGN	陈国提	DATE				
			AUDITING		DATE				
MARKER	MODIFY	FILE NO	SIGNATURE	DATE	APPROV				

 PANASIA ALUMINUM (CHINA) LIMITED

CUSTOMER	HONGKONG CO.	CUSTOMER APPROVAL	CUST PART NO.	X85550 ✓
			SECTION NO.	LH0089916

M6

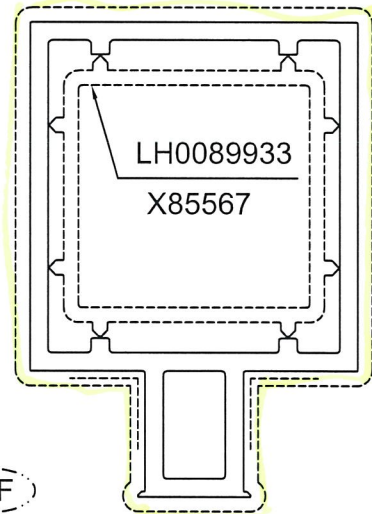
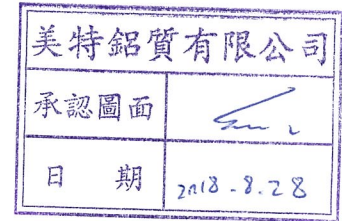
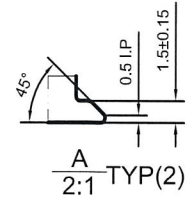
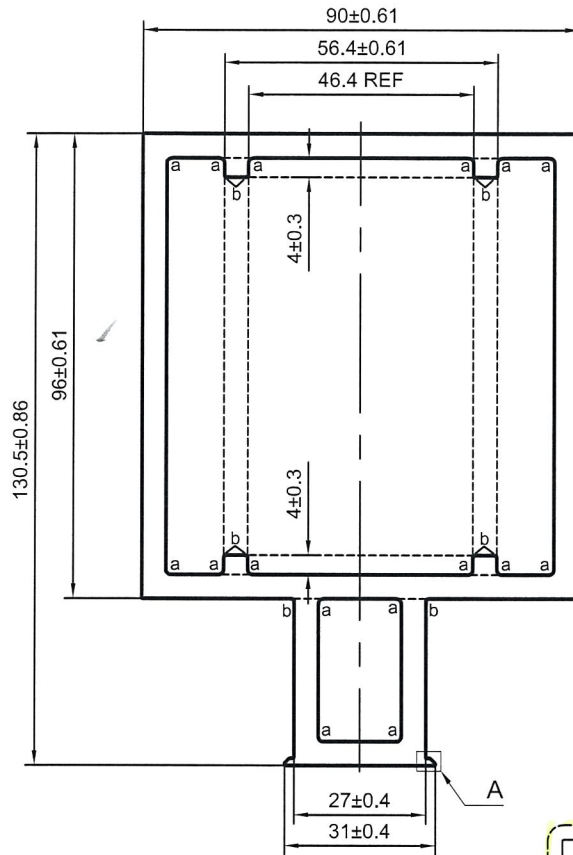

V.F

a=R1 b=R0.5

----- 次要装饰面, 喷涂膜厚不足, 但不露底
 - - - - - 装饰面

*配合尺寸以实物配合效果为准!

SIGNATURE GRADEING	HIGH SIGNATURE GRADEING	C.C.DIA(MM)	Ø147.29		SCALE 1:2				
AREA (SQ MM)	2278.03	UNSPECIFIED THICKNESS	5±0.35	PERIMETER (MM)	446.32	STANDARD	GB 5237.1	SCALE	1:1.5
MASS (KG/M)	6.173	UNSPECIFIED CORNERS	R 0.3	SURFACE AREA	446.32	ALLOY	6063-T6	VERSION	A
COMPANY ISSUE		A	DRAWN	蔡晓婷	DATE	2018-08-24	APPELLATION	-	PAGE OF
			STANDARDIZATION		DATE				
			TO SIGN	陈国提	DATE				
			AUDITING		DATE				
MARKER	MODIFY	FILE NO	SIGNATURE	DATE	APPROV	DATE			



PANASIA ALUMINUM (CHINA) LIMITED

CUSTOMER	HONGKONG CO.	CUSTOMER APPROVAL	CUST PART NO.	X85553
			SECTION NO.	LH0089919

T2

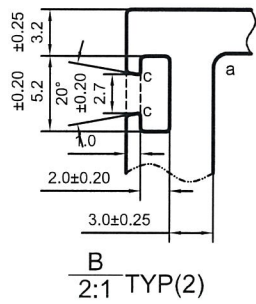
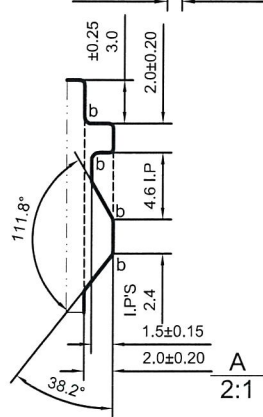
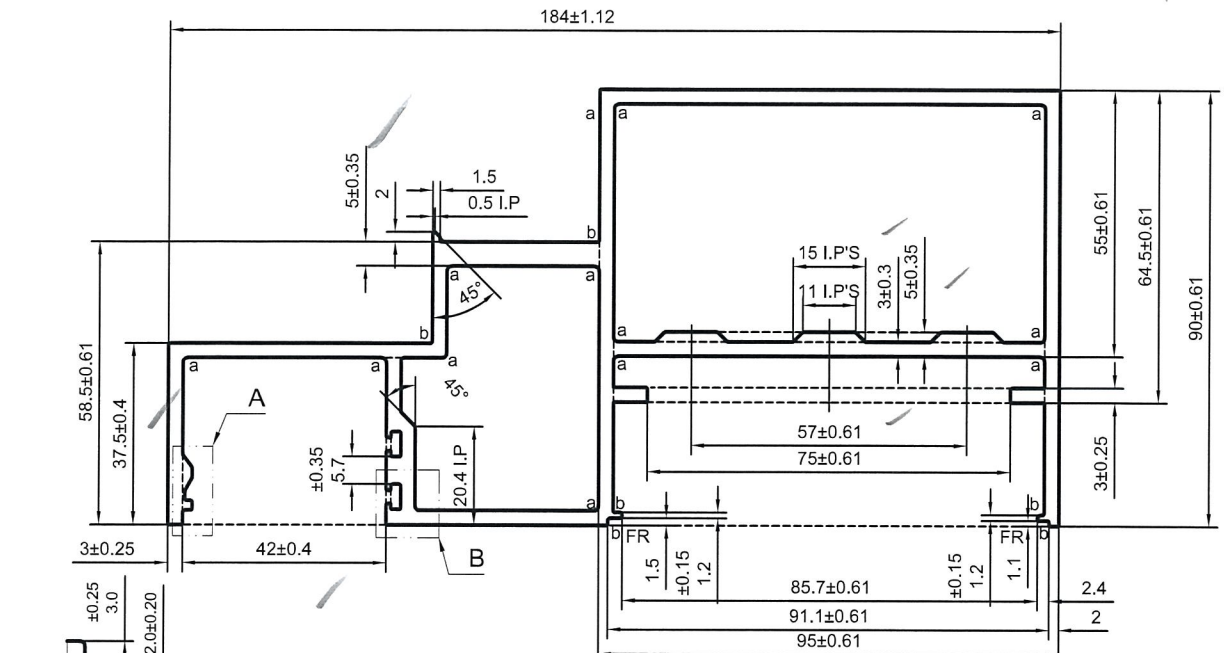

美特鋁質有限公司
承認圖面
日期 2018-8-28

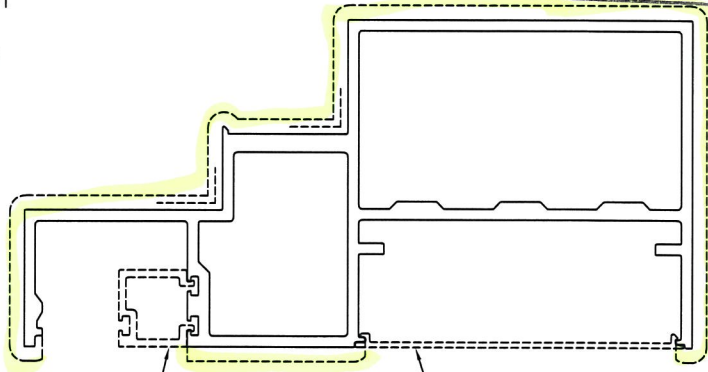

a=R1 b=R0.5 c=R0.2

----- 次要装饰面, 喷涂膜厚不足, 但不露底
- - - - - 装饰面

*配合尺寸以实物配合效果为准!

SIGNATURE GRADEING	HIGH SIGNATURE GRADEING	C.C.DIA(MM)	Ø204.63		SCALE 1:2				
AREA (SQ MM)	1968.77	UNSPECIFIED THICKNESS	3±0.25	PERIMETER (MM)	742.29	STANDARD	GB 5237.1	SCALE	1:1.5
MASS (KG/M)	5.335	UNSPECIFIED CORNERS	R 0.3	SURFACE AREA	431.88	ALLOY	6063-T6	VERSION	A
COMPANY ISSUE	A	DRAWN	蔡晓婷	DATE	2018-08-25	APPELLATION	-	PAGE OF	
		STANDARDIZATION		DATE					
		TO SIGN	陈国提	DATE					
		AUDITING		DATE					
MARKER	MODIFY	FILE NO	SIGNATURE	DATE	APPROV				

PANASIA ALUMINUM (CHINA) LIMITED

CUSTOMER	HONGKONG CO.	CUSTOMER APPROVAL	CUST PART NO.	X85554
			SECTION NO.	LH0089920

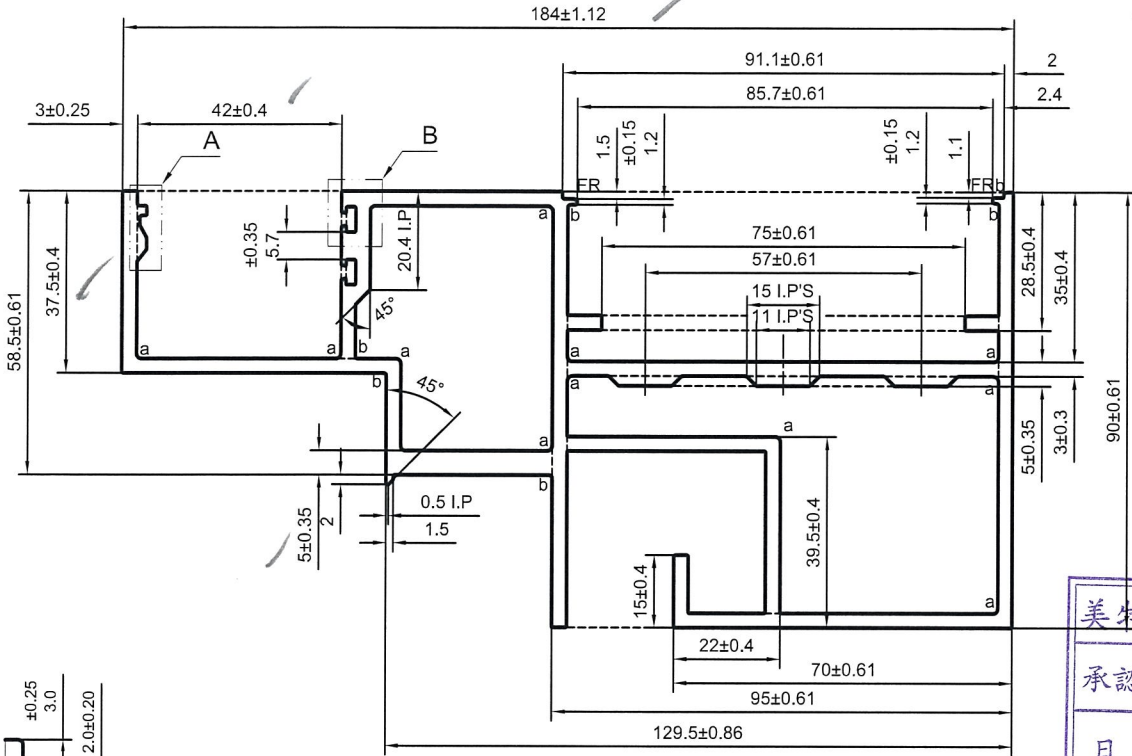

美特鋁質有限公司
承認圖面
日期 2018-8-28

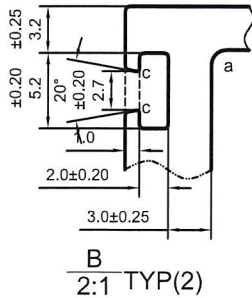
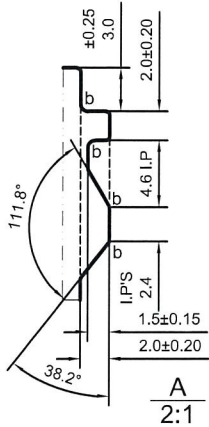

a=R1 b=R0.5 c=R0.2

----- 次要装饰面, 喷涂膜厚不足, 但不露底
 - - - - - 装饰面
 ●●●●● 凹槽位置可能会有露底现象, 即膜厚不足

*配合尺寸以实物配合效果为准!

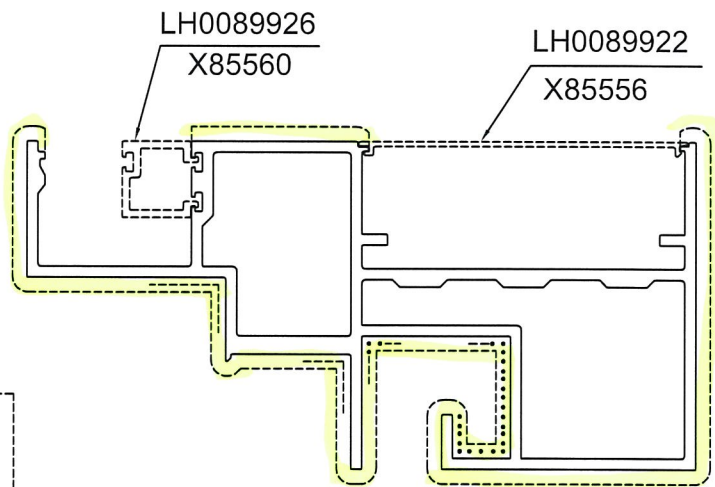

(V.F)

SCALE 1:2

SIGNATURE GRADEING	HIGH SIGNATURE GRADEING	C.C.DIA(MM)	Ø204.63		SCALE 1:2				
AREA (SQ MM)	2170.88	UNSPECIFIED THICKNESS	3±0.25	PERIMETER (MM)	876.26	STANDARD	GB 5237.1	SCALE	1:1.5
MASS (KG/M)	5.883	UNSPECIFIED CORNERS	R 0.3	SURFACE AREA	565.85	ALLOY	6063-T6	VERSION	A
COMPANY ISSUE		A	DRAWN	蔡晓婷	DATE	2018-08-25	APELLATION	-	PAGE OF
			STANDARDIZATION		DATE				
			TO SIGN	陈国提	DATE				
			AUDITING		DATE				
MARKER	MODIFY	FILE NO	SIGNATURE	DATE	APPROV	DATE			



PANASIA ALUMINUM (CHINA) LIMITED

CUSTOMER	HONGKONG CO.	CUSTOMER APPROVAL		CUST PART NO.	X85556
				SECTION NO.	LH0089922

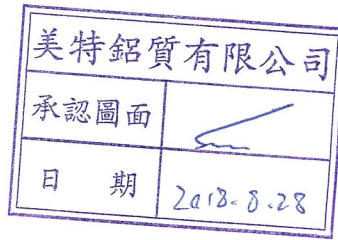

A01

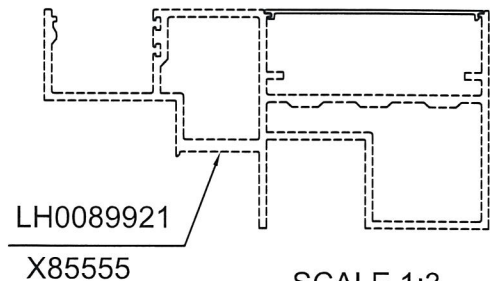
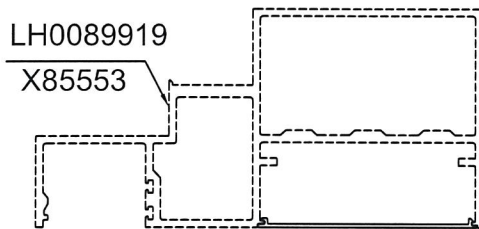
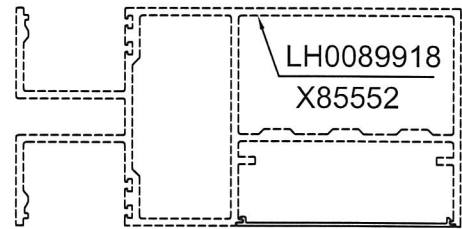
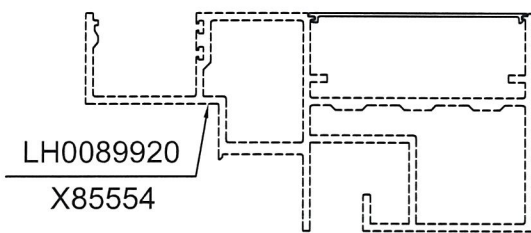
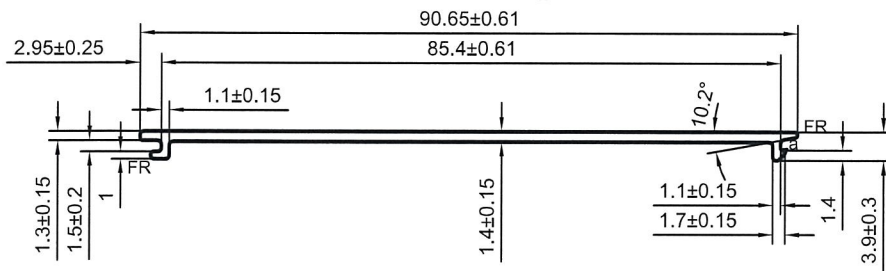

SCALE 1:3

a=R0.3

*配合尺寸以实物配合效果为准!

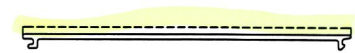

V.F
SCALE 1:2

SIGNATURE GRADEING	HIGH SIGNATURE GRADEING	C.C.DIA(MM)	Ø90.65						
AREA (SQ MM)	132.58	UNSPECIFIED THICKNESS	-	PERIMETER (MM)	194.35	STANDARD	GB 5237.1	SCALE	1:1
MASS (KG/M)	0.359	UNSPECIFIED CORNERS	R 0.5	SURFACE AREA	91.66	ALLOY	6063-T5	VERSION	A
COMPANY ISSUE		A	DRAWA	蔡晓婷	DATE	2018-08-25	APELLATION	-	PAGE OF
			STANDA-RDIZATION		DATE				
			TO SIGN	陈国提	DATE				
			AUDITING		DATE				
MARKER	MODIFY	FILE NO	SIGNATURE	DATE	APPROV				

PANASIA ALUMINUM (CHINA) LIMITED

CUSTOMER	HONGKONG CO.	CUSTOMER APPROVAL	CUST PART NO.	X85558
			SECTION NO.	LH0089924

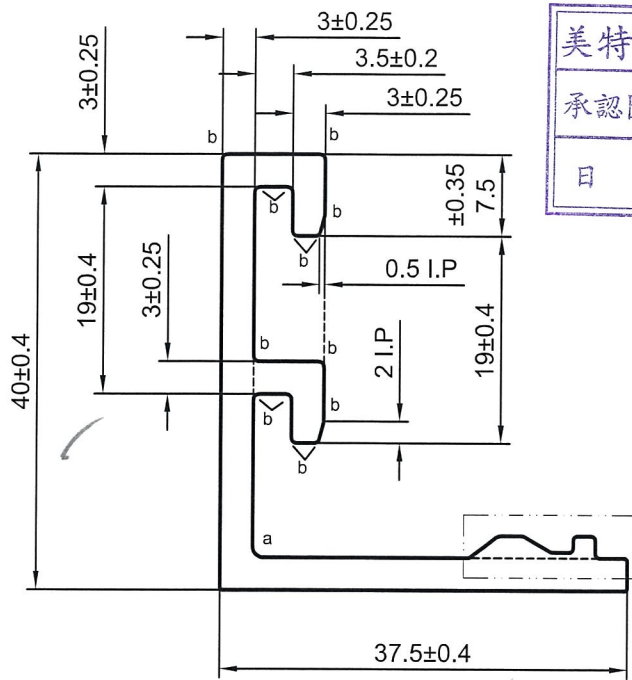

美特鋁質有限公司
承認圖面
日期 2018-8-28

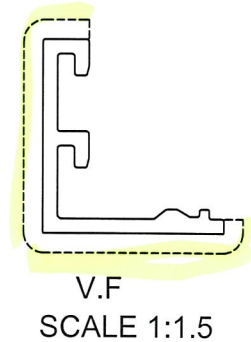
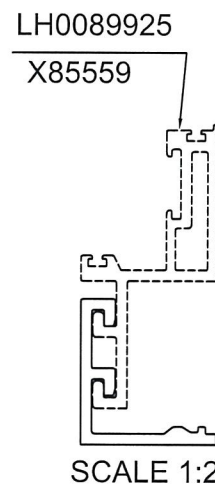
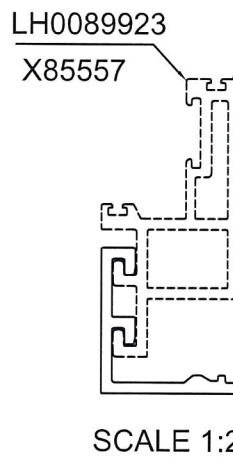
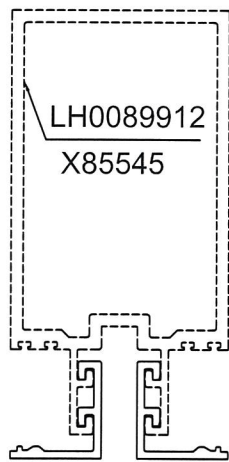
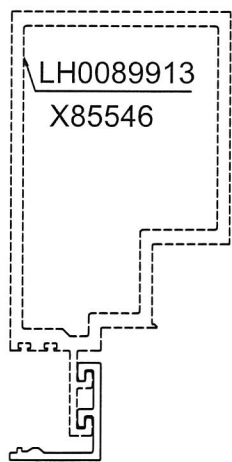
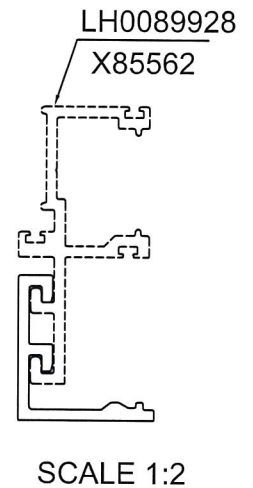
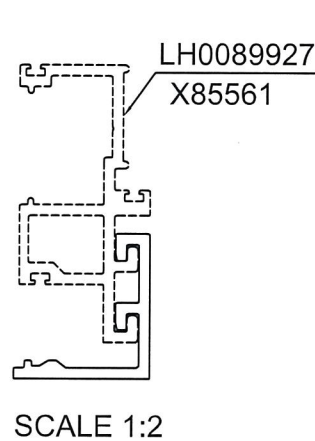
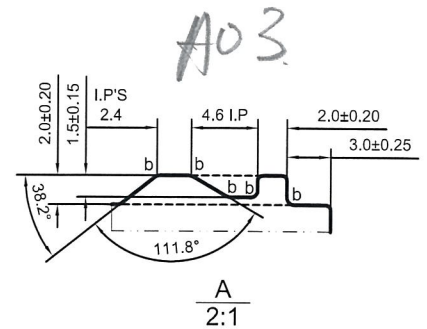

a=R1 b=R0.5

*配合尺寸以实物配合效果为准!

SIGNATURE GRADEING	HIGH SIGNATURE GRADEING	C.C.DIA(MM)	Ø54.5						
AREA (SQ MM)	304.18	UNSPECIFIED THICKNESS	3±0.25	PERIMETER (MM)	198.8	STANDARD	GB 5237.1	SCALE	1.5:1
MASS (KG/M)	0.824	UNSPECIFIED CORNERS	R 0.3	SURFACE AREA	89.98	ALLOY	6063-T6	VERSION	A
COMPANY ISSUE		A	DRAWN	蔡晓婷	DATE	2018-08-24	APPELLATION	-	PAGE OF
			STANDARDIZATION		DATE				
			TO SIGN	陈国提	DATE				
			AUDITING		DATE				
MARKER	MODIFY	FILE NO	SIGNATURE	DATE	APPROV	DATE			

 PANASIA ALUMINUM (CHINA) LIMITED

CUSTOMER	HONGKONG CO.	CUSTOMER APPROVAL	CUST PART NO.	X85563
			SECTION NO.	LH0089929

A08

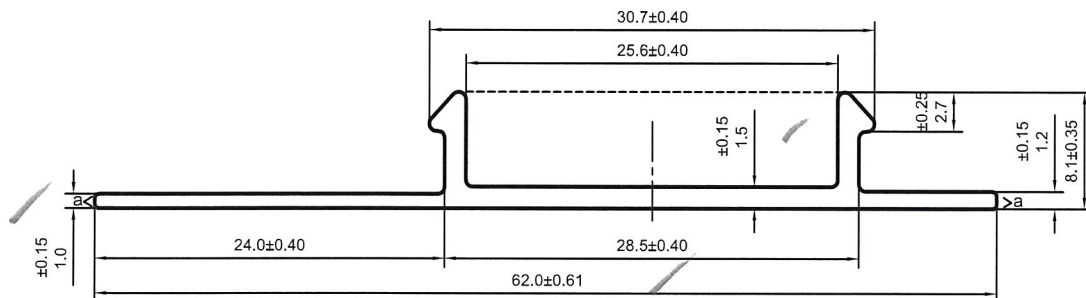

LH0089927

X85561

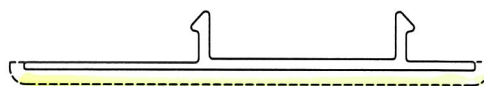
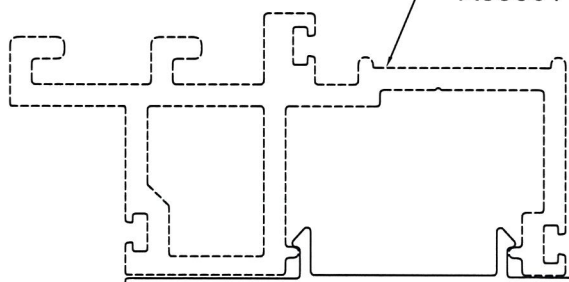

a=R0.3

*配合尺寸以实物配合效果为准!

V.F

SCALE 1:1

SIGNATURE GRADEING	HIGH SIGNATURE GRADEING	C.C.DIA(MM)	Ø62						
AREA (SQ MM)	99.28	UNSPECIFIED THICKNESS	-	PERIMETER (MM)	152.47	STANDARD	GB 5237.1	SCALE	2:1
MASS (KG/M)	0.269	UNSPECIFIED CORNERS	R 0.5	SURFACE AREA	64.29	ALLOY	6063-T5	VERSION	A
COMPANY ISSUE		A	DRAWA	蔡晓婷	DATE	2018-08-25	APELLATION	-	PAGE OF
			STANDA-RDIZATION		DATE				
			TO SIGN	陈国提	DATE				
			AUDITING		DATE				
MARKER	MODIFY	FILE NO	SIGNATURE	DATE	APPROV				



PANASIA ALUMINUM (CHINA) LIMITED

CUSTOMER	HONGKONG CO.	CUSTOMER APPROVAL		CUST PART NO.	X85564
				SECTION NO.	LH0089930

A09

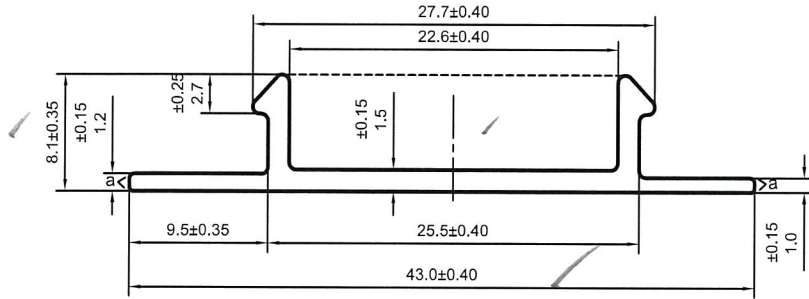

美特鋁質有限公司
承認圖面
日期 2018-8-28

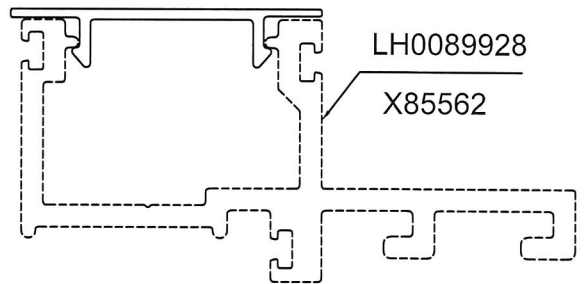

V.F

SCALE 1:1

a=R0.3

*配合尺寸以实物配合效果为准!

SIGNATURE GRADEING	HIGH SIGNATURE GRADEING	C.C.DIA(MM)	Ø43						
AREA (SQ MM)	78.78	UNSPECIFIED THICKNESS	-	PERIMETER (MM)	114.47	STANDARD	GB 5237.1	SCALE	2:1
MASS (KG/M)	0.213	UNSPECIFIED CORNERS	R 0.5	SURFACE AREA	45.29	ALLOY	6063-T5	VERSION	A
COMPANY ISSUE		A	DRAWN	蔡晓婷	DATE	2018-08-25	APPELLATION	-	PAGE OF
			STANDARDIZATION		DATE				
			TO SIGN	陈国提	DATE				
			AUDITING		DATE				
MARKER	MODIFY	FILE NO	SIGNATURE	DATE	APPROV	DATE			



PANASIA ALUMINUM (CHINA) LIMITED

CUSTOMER	HONGKONG CO.	CUSTOMER APPROVAL	CUST PART NO.	X85565
			SECTION NO.	LH0089931

A10

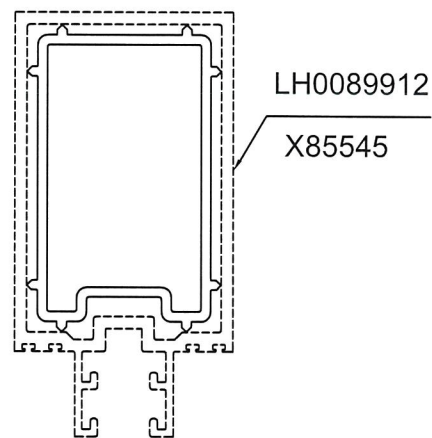
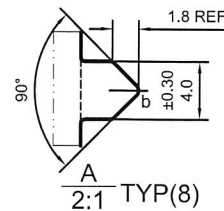
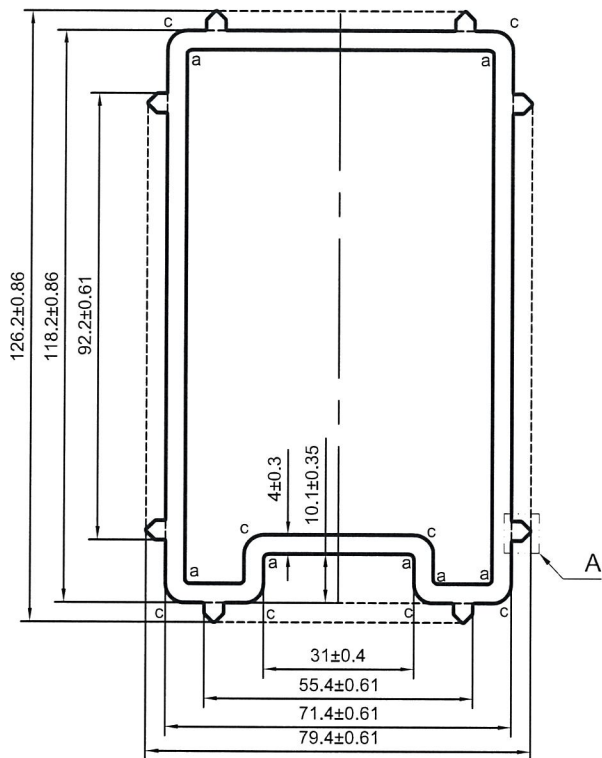

美特鋁質有限公司	
承認圖面	
日期	2018-8-28

a=R1 b=R0.5 c=R4

*配合尺寸以实物配合效果为准!

NO V.F
SCALE 1:3

SIGNATURE GRADEING	HIGH SIGNATURE GRADEING	C.C.DIA(MM)	Ø136.34						
AREA (SQ MM)	1610.32	UNSPECIFIED THICKNESS	4±0.3	PERIMETER (MM)	432.83	STANDARD	GB 5237.1	SCALE	1:1.5
MASS (KG/M)	4.364	UNSPECIFIED CORNERS	R 0.3	SURFACE AREA	-	ALLOY	6061-T6	VERSION	A
COMPANY ISSUE		A	DRAWA	蔡晓婷	DATE	2018-08-25	APELLATION	-	PAGE OF
			STANDA-RDIZATION		DATE				
			TO SIGN	陈国提	DATE				
			AUDITING		DATE				
MARKER	MODIFY	FILE NO	SIGNATURE	DATE	APPROV				

PANASIA ALUMINUM (CHINA) LIMITED

CUSTOMER	HONGKONG CO.	CUSTOMER APPROVAL	CUST PART NO.	X85566
			SECTION NO.	LH0089932

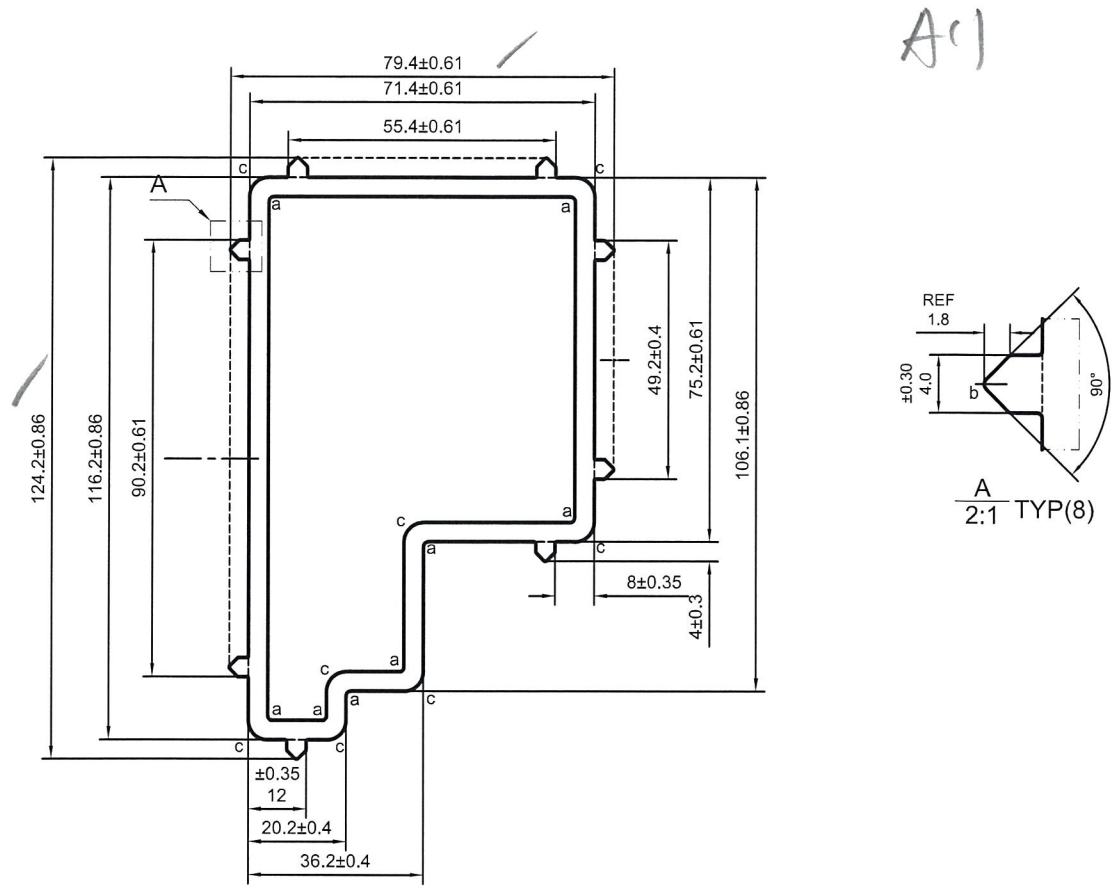

美特鋁質有限公司
承認圖面
日期 2018.8.28

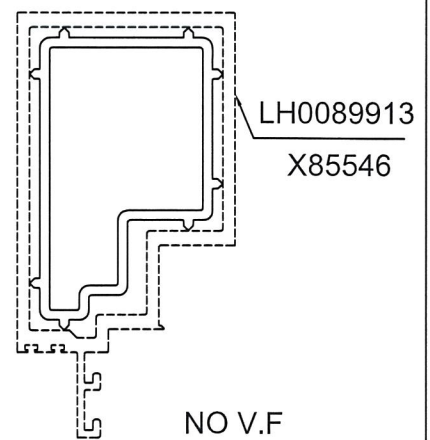

a=R1 b=R0.5 c=R4

*配合尺寸以实物配合效果为准!

NO V.F
SCALE 1:3

SIGNATURE GRADEING	HIGH SIGNATURE GRADEING	C.C.DIA(MM)	Ø134.49						
AREA (SQ MM)	1513.52	UNSPECIFIED THICKNESS	4±0.3	PERIMETER (MM)	408.63	STANDARD	GB 5237.1	SCALE	1:1.5
MASS (KG/M)	4.102	UNSPECIFIED CORNERS	R 0.3	SURFACE AREA	-	ALLOY	6061-T6	VERSION	A
COMPANY ISSUE		A	DRAWA	蔡晓婷	DATE	2018-08-25	APPELLATION	-	PAGE OF
			STANDA-RDIZATION		DATE				
			TO SIGN	陈国提	DATE				
			AUDITING		DATE				
MARKER	MODIFY	FILE NO	SIGNATURE	DATE	APPROV	DATE			

PANASIA ALUMINUM (CHINA) LIMITED

CUSTOMER	HONGKONG CO.	CUSTOMER APPROVAL	CUST PART NO.	X85567
			SECTION NO.	LH0089933

A12

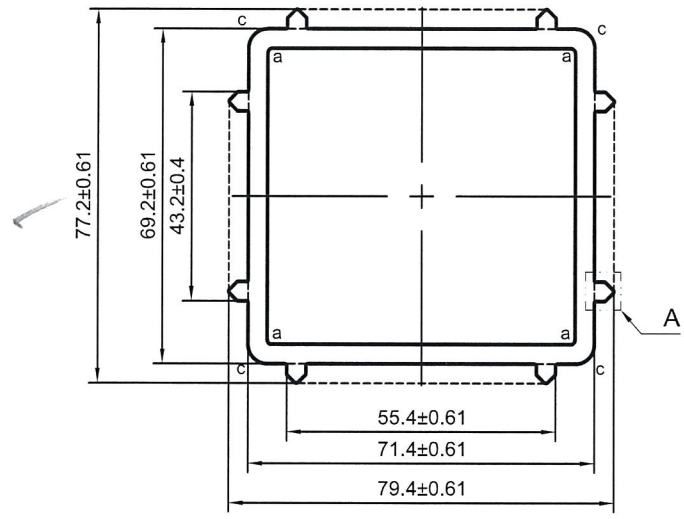

美特鋁質有限公司
承認圖面
日期 2018.8.28

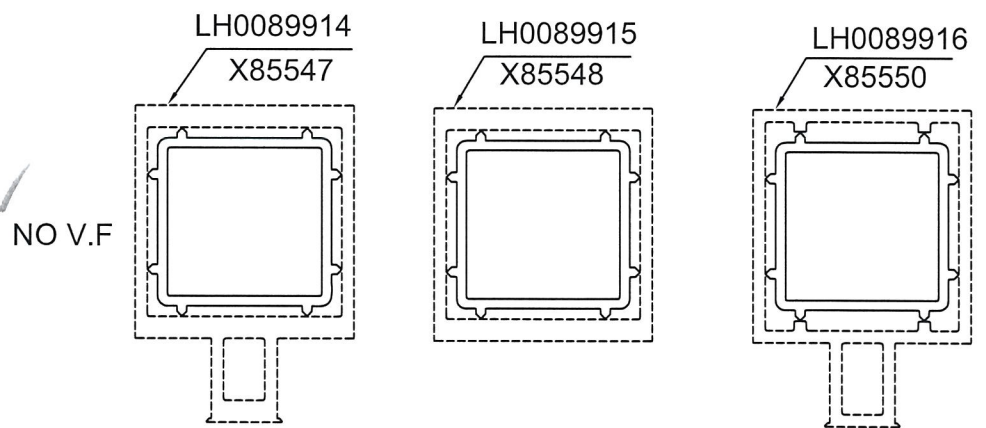

a=R1 b=R0.5 c=R4

SCALE 1:3

SCALE 1:3

SCALE 1:3

*配合尺寸以实物配合效果为准!

SIGNATURE GRADEING	HIGH SIGNATURE GRADEING	C.C.DIA(MM)	Ø96.12	
AREA (SQ MM)	1150.4	UNSPECIFIED THICKNESS	4±0.3	PERIMETER (MM) 318.92
MASS (KG/M)	3.118	UNSPECIFIED CORNERS	R 0.3	SURFACE AREA -
COMPANY ISSUE		A	DRAWN 蔡晓婷	DATE 2018-08-24
			STANDARDIZATION	DATE
			TO SIGN 陈国提	DATE
			AUDITING	DATE
MARKER	MODIFY FILE NO	SIGNATURE	DATE	APPROV DATE

PANASIA ALUMINUM (CHINA) LIMITED

CUSTOMER	HONGKONG CO.	CUSTOMER APPROVAL		CUST PART NO.	X85578
				SECTION NO.	LH0089937

509

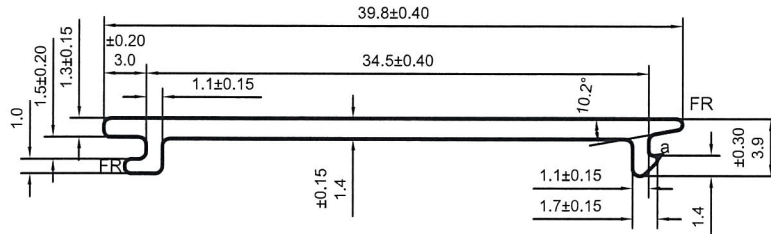

美特鋁質有限公司	
承認圖面	
日期	2018-8-28

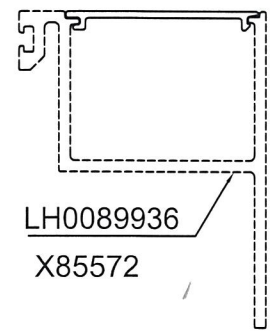
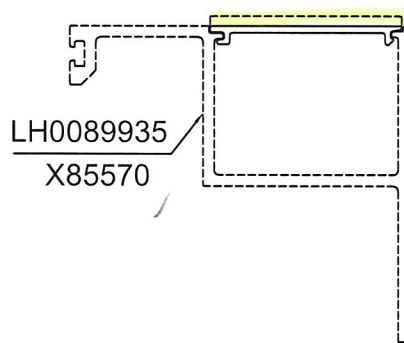

a=R0.3

*配合尺寸以实物配合效果为准!

V.F
SCALE 1:1.5

SIGNATURE GRADEING	HIGH SIGNATURE GRADEING	C.C.DIA(MM)	Ø39.75						
AREA (SQ MM)	61.32	UNSPECIFIED THICKNESS	-	PERIMETER (MM)	92.54	STANDARD	GB 5237.1	SCALE	2:1
MASS (KG/M)	0.166	UNSPECIFIED CORNERS	R 0.3	SURFACE AREA	40.76	ALLOY	6063-T5	VERSION	A
COMPANY ISSUE		A	DRAWA	蔡晓婷	DATE	2018-08-24	APPELLATION	-	PAGE OF
			STANDA-RDIZATION		DATE				
			TO SIGN	陈国提	DATE				
			AUDITING		DATE				
MARKER	MODIFY	FILE NO	SIGNATURE	DATE	APPROV				

PANASIA ALUMINUM (CHINA) LIMITED

CUSTOMER	HONGKONG CO.	CUSTOMER APPROVAL	CUST PART NO.	X85593
			SECTION NO.	LH0089939

AB2.

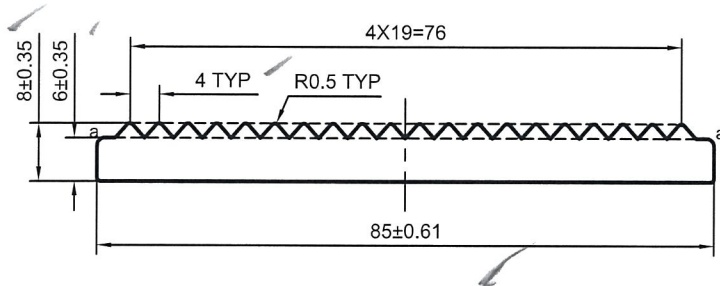

美特鋁質有限公司	
承認圖面	
日期	2018.8-28

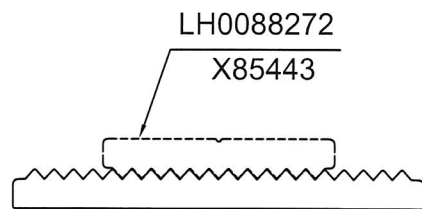

a=R1

*配合尺寸以实物配合效果为准!

NO V.F
SCALE 1:1.5

SIGNATURE GRADEING	HIGH SIGNATURE GRADEING	C.C.DIA(MM)	Ø85.12						
AREA (SQ MM)	598.2	UNSPECIFIED THICKNESS	-	PERIMETER (MM)	215.54	STANDARD	GB 5237.1	SCALE	1:1
MASS (KG/M)	1.621	UNSPECIFIED CORNERS	R 0.5	SURFACE AREA	-	ALLOY	6061-T6	VERSION	A
COMPANY ISSUE		A	DRAWN	蔡晓婷	DATE	2018-08-25	APPELLATION	-	PAGE OF
			STANDARDIZATION		DATE				
			TO SIGN	陈国提	DATE				
			AUDITING		DATE				
MARKER	MODIFY	FILE NO	SIGNATURE	DATE	APPROV				

PANASIA ALUMINUM (CHINA) LIMITED

CUSTOMER	HONGKONG CO.	CUSTOMER APPROVAL	CUST PART NO.	X85594 ✓
			SECTION NO.	LH0089940

ABY.

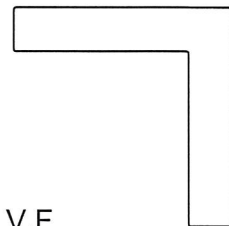
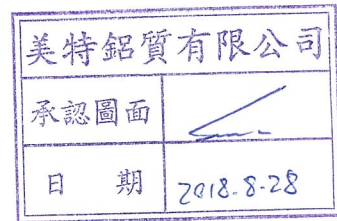
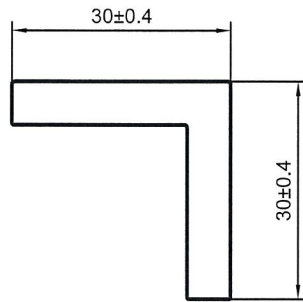

NO V.F
SCALE 1:1

*配合尺寸以实物配合效果为准!

SIGNATURE GRADEING	HIGH SIGNATURE GRADEING	C.C.DIA(MM)	Ø42.18	
AREA (SQ MM)	323.92	UNSPECIFIED THICKNESS	6±0.35	PERIMETER (MM)
MASS (KG/M)	0.878	UNSPECIFIED CORNERS	R 0.3	SURFACE AREA
COMPANY ISSUE		A	DRAWN	蔡晓婷
			DATE	2018-08-24
			STANDARDIZATION	DATE
			TO SIGN	陈国提
			DATE	
			AUDITING	DATE
MARKER	MODIFY FILE NO	SIGNATURE	DATE	APPROV
				DATE

 PANASIA ALUMINUM (CHINA) LIMITED