



工程指示 / 要求簡箋(E.I.)

工程指示編號：EI / 9685 / 18

修改版次：C

工程編號：J - 837

工程名稱：觀塘裕民坊

工程項目：幕牆 鋁料模具生產(7 個)

收件人：Maggie

發件人：Eric Liu

日期：11/09/2018

要求提供 / 確認 事項：

- | | | |
|------------------------------------|-------------------------------------|-------------------------------|
| <input type="checkbox"/> 初步鋁料 B.M. | <input type="checkbox"/> 加工拆圖，然後生產 | <input type="checkbox"/> 尺寸表 |
| <input type="checkbox"/> 正式鋁料 B.M. | <input type="checkbox"/> 技術上資料 / 指示 | <input type="checkbox"/> 報價 |
| <input type="checkbox"/> 配件 B.M. | <input type="checkbox"/> 樣辦或貨品說明書 | <input type="checkbox"/> 分判合約 |
| <input type="checkbox"/> 其他：_____ | | |

內容：

C 版簽批已修改的模具，共 7 個

(X85545,X85546,X85548,X85551,X85558,X85560,X85569)

謝謝！

請在 2018/ 09 / 30 前完成上列要求。

附：7 頁模圖+1 頁

以上項目為：

- 原合約工程包 原合約工程加 / 減賬 新工程報價

原因：-

分發東莞各部門：

- () 生產技術總監 連附件 () 技術部 連附件 *材料* () 生產部 連附件 () 機械設計部 連附件
 () 採購部 連附件 () 生產統籌部 連附件 *物*
 () 質檢部 連附件 () 會計部 連附件 () 報關組 連附件 () 其他 楊榮輝 連附件

分發其他分判：

- () 王禮秋 連附件

分發香港各部門：

- () 行政部 連附件 () 會計部 連附件 () 統籌部 連附件 () 工程部地盤科文 連附件
 () 採購部 連附件 () QS 部 連附件 () 維修部 連附件 () 其他 _____ 連附件

傳遞編號：

HK 1444 / 18

發件人簽署：
[Signature]

項目經理簽署：
[Signature]

EI9685

28/08/2018 30/08/2018 04/09/2018 11/09/2018

Page	PART	Grade	榮陽DIE No.	Die No.	0	A	B	C	D
1	M1	6063	T6	LH0089912	X85545			1	
2	M2	6063	T6	LH0089913	X85546			1	
3	M3	6063	T6	LH0089914	X85547	1		1	
4	M4	6063	T6	LH0089915	X85548			1	
5	M5	6063	T6		X85549				
6	M6	6063	T6	LH0089916	X85550	1		1	
7	M7	6063	T6	LH0089917	X85551			1	
8	T1	6063	T6	LH0089918	X85552				
9	T2	6063	T6	LH0089919	X85553	1		1	
10	T3	6063	T6	LH0089920	X85554	1		1	
11	T3A	6063	T6	LH0089921	X85555	1		1	
12	A01	6063	T5	LH0089922	X85556	1		1	
13	A02	6063	T6	LH0089923	X85557				
14	A03	6063	T6	LH0089924	X85558	1	暫停	1	
15	A04	6063	T6	LH0089925	X85559				
16	A05	6063	T6	LH0089926	X85560			1	
17	A06	6063	T6	LH0089927	X85561				
18	A07	6063	T6	LH0089928	X85562				
19	A08	6063	T5	LH0089929	X85563	1		1	
20	A09	6063	T5	LH0089930	X85564	1		1	
21	A10	6061	T6	LH0089931	X85565	1			
22	A11	6061	T6	LH0089932	X85566	1			
23	A12	6061	T6	LH0089933	X85567	1			
24	A13	6061	T6		X85568				
25	A14	6061	T6	LH0089934	X85569			1	
26	S01	6063	T6	LH0089935	X85570				
27	S02	6063	T5		X85571				
28	S03	6063	T6	LH0089936	X85572				
29	S04	6063	T6		X85573				
30	S05	6063	T6		X85574				
31	S06	6063	T6		X85575				
32	S07	6063	T6		X85576				
33	S08	6063	T6		X85577				
34	S09	6063	T5	LH0089937	X85578	1		1	
35	S10	6063	T6		X85579				
36	S12	6063	T6		X85580				
37	S13	6063	T6		X85581				
38	S15	6063	T6		X85582				
39	S16	6063	T6		X85583				
40	S17	6063	T5		X85584				
41	S18	6063	T6		X85585				
42	S19	6063	T6		X85586				
43	F01	6063	T6		X85587				
44	F02	6063	T6		X85588				
45	F03	6063	T5		X85589				
46	F04	6063	T6		X85590				
47	F05	6063	T6		X85591				
48	AB01	6061	T6	LH0089938	X85592				
49	AB2	6061	T6	LH0089939	X85593	1	暫停		
50	AB4	6061	T6	LH0089940	X85594	1		1	
51	AB5	6063	T5	LH0089941	X85595				
52	A15	6063	T6		X85596				
53	A16	6063	T5		X85597				
54	A17	6061	T6		X85598				
					15	2暫停	10	7	

E19685 C

CUSTOMER	HONGKONG CO.	CUSTOMER APPROVAL	CUST PART NO.	X85545
			SECTION NO.	LH0089912

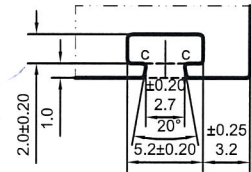
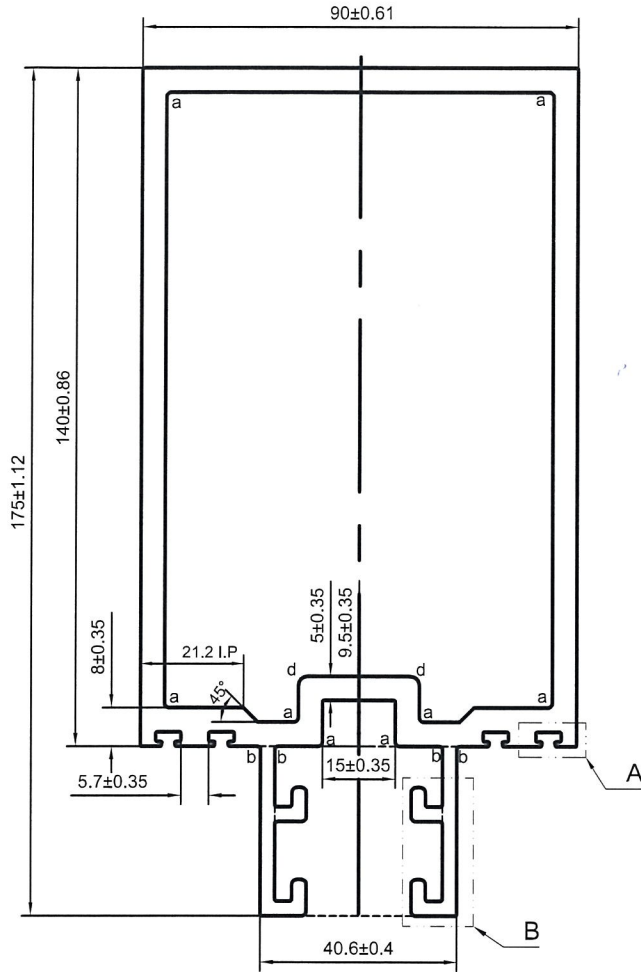

A
2:1 TYP(4)

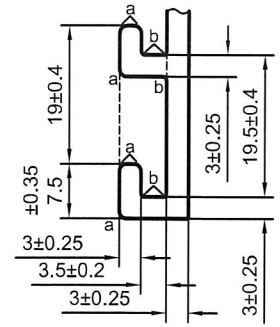

B
1:1 TYP(2)

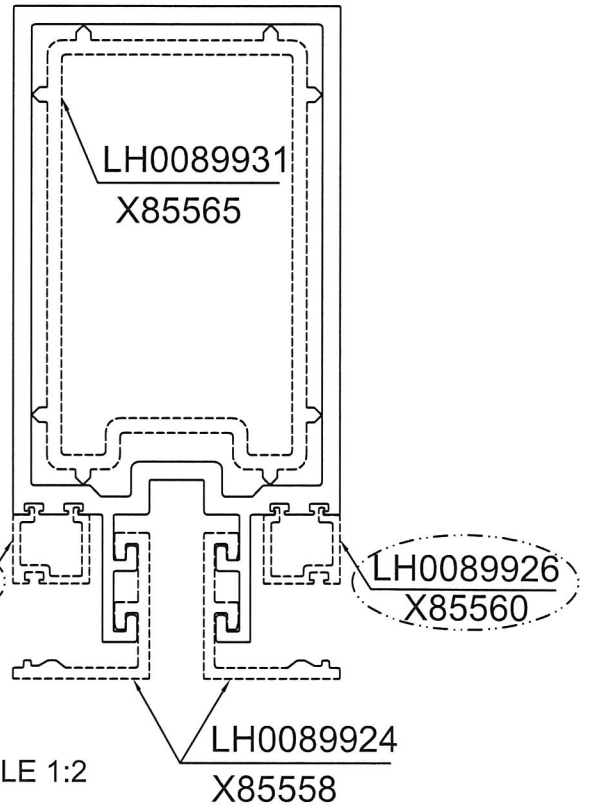

美特鋁質有限公司
承認圖面
日期 2018.9.11

a=R1 b=R0.5
c=R0.2 d=R2

*配合尺寸以实物配合效果为准！

SIGNATURE GRADEING	HIGH SIGNATURE GRADEING	C.C.DIA(MM)	Ø188.47	
AREA (SQ MM)	2684.8	UNSPECIFIED THICKNESS	5±0.35	PERIMETER (MM) 734.7
MASS (KG/M)	7.276	UNSPECIFIED CORNERS	R 0.3	SURFACE AREA 423.14
COMPANY ISSUE	A	DRAWN	蔡晓婷	DATE 2018-08-29
		STANDARDIZATION		DATE
		TO SIGN	陈国提	DATE
		AUDITING		DATE
MARKER	MODIFY FILE NO	SIGNATURE	DATE	APPROV DATE

PANASIA ALUMINUM (CHINA) LIMITED

CUSTOMER	HONGKONG CO.	CUSTOMER APPROVAL	CUST PART NO.	X85545
			SECTION NO.	LH0089912

M1

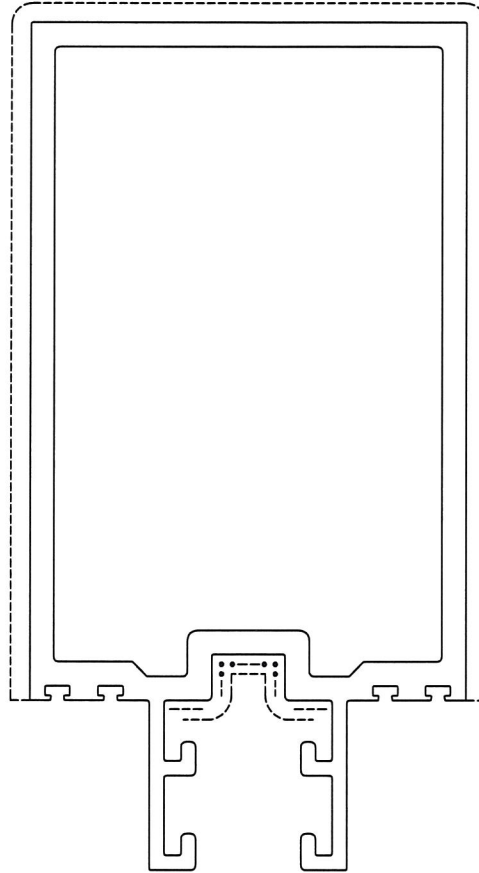

V.F.
SCALE 1:1.5

美特鋁質有限公司
承認圖面
日期 2018-9-11

----- 次要裝飾面，噴塗膜厚不足，但不露底
----- 裝飾面
●●●●●● 凹槽位置可能會有露底現象，即膜厚不足

*配合尺寸以实物配合效果为准！

SIGNATURE GRADEING	HIGH SIGNATURE GRADEING	C.C.DIA(MM)	Ø188.47	
AREA (SQ MM)	2684.8	UNSPECIFIED THICKNESS	5±0.35	PERIMETER (MM) 734.7
MASS (KG/M)	7.276	UNSPECIFIED CORNERS	R 0.3	SURFACE AREA (423.14)
COMPANY ISSUE		A	DRAWN 蔡晓婷	DATE 2018-08-29
			STANDARDIZATION	DATE
			TO SIGN 陈国提	DATE
			AUDITING	DATE
MARKER	MODIFY FILE NO	SIGNATURE	DATE	APPROV DATE

 PANA Asia ALUMINUM (CHINA) LIMITED

CUSTOMER	HONGKONG CO.	CUSTOMER APPROVAL	CUST PART NO.	X85546
			SECTION NO.	LH0089913

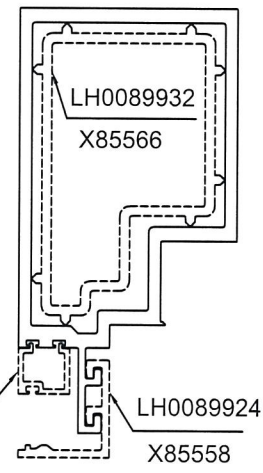
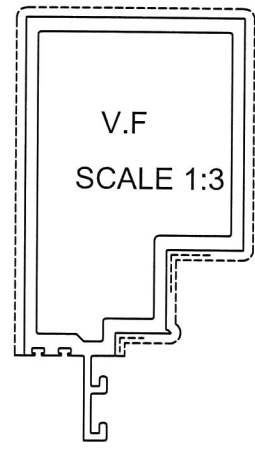
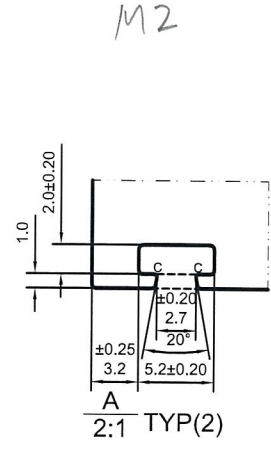
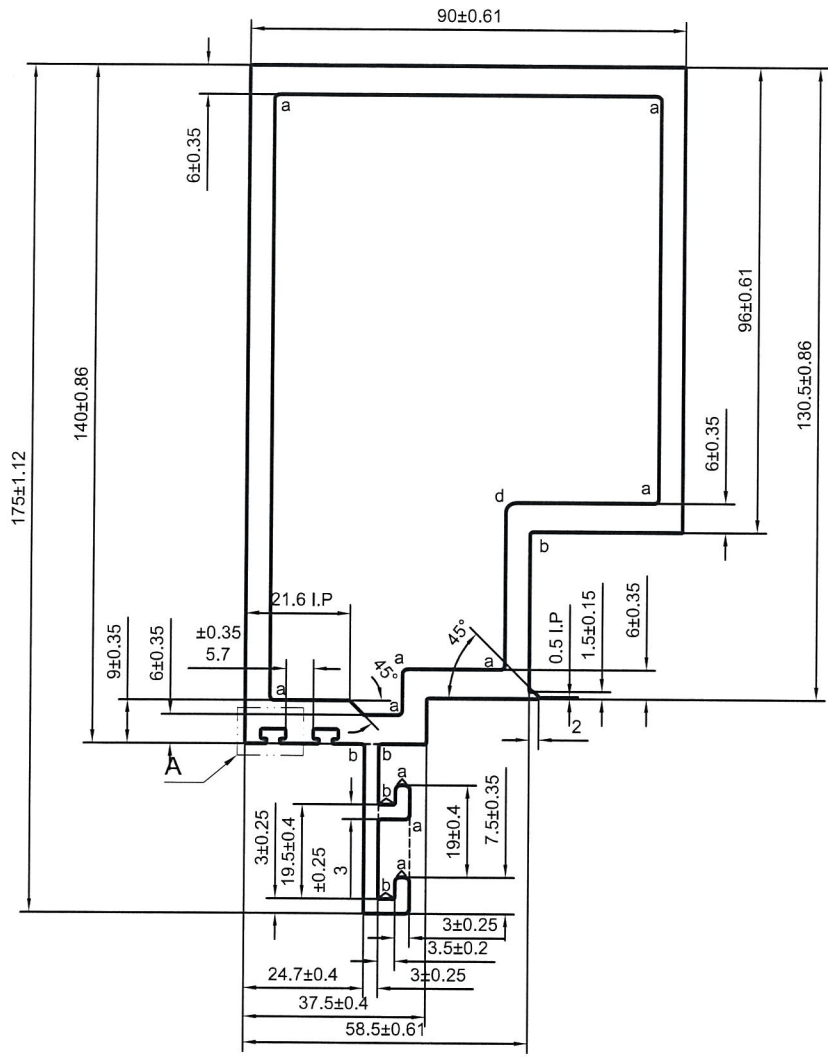

a=R1 b=R0.5
c=R0.2 d=R2

美特鋁質有限公司
承認圖面
日期 2018.9.11

--- 次要裝飾面，噴塗膜厚不足，但不露底
--- 裝飾面

*配合尺寸以实物配合效果为准！

SIGNATURE GRADEING	HIGH SIGNATURE GRADEING	C.C.DIA(MM)	Ø188.47	SCALE 1:3					
AREA (SQ MM)	2559.24	UNSPECIFIED THICKNESS	5±0.35	PERIMETER (MM)	590.73	STANDARD	BS EN755	SCALE	1:1.5
MASS (KG/M)	6.936	UNSPECIFIED CORNERS	R 0.3	SURFACE AREA	425.36	ALLOY	6063-T6	VERSION	B
COMPANY ISSUE		A	DRAWN	蔡晓婷	DATE	2018-08-29	APPELLATION	-	PAGE OF
			STANDARDIZATION		DATE				
			TO SIGN	陈国提	DATE				
			AUDITING		DATE				
MARKER	MODIFY	FILE NO	SIGNATURE	DATE	APPROV	DATE			

 PANASIA ALUMINUM (CHINA) LIMITED

CUSTOMER	HONGKONG CO.	CUSTOMER APPROVAL	CUST PART NO.	X85560
			SECTION NO.	LH0089926

A05

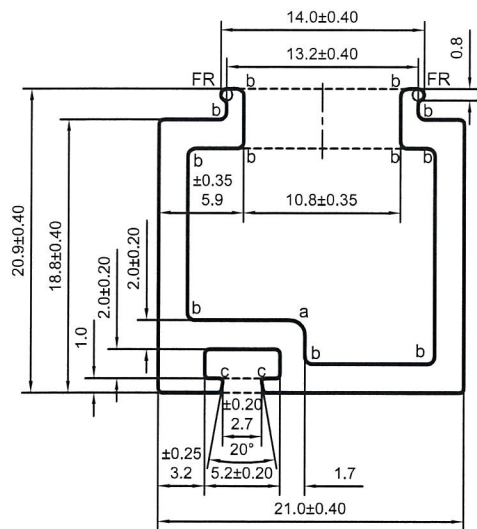

LH0089913
X85546

SCALE 1:4

LH0089920

X85554

LH0089912
X85545

SCALE 1:4

LH0089919
X85553

LH0089918
X85552

LH0089921
X85555

a=R1 b=R0.5 c=R0.2

----- 次要装饰面, 喷涂膜厚不足, 但不露底
 - - - - - 装饰面
 ●●●●● 凹槽位置可能会有露底现象, 即膜厚不足

*配合尺寸以实物配合效果为准!

SCALE 1:3

美特铝质有限公司

承認圖面

日期 2018.9.11

V.F

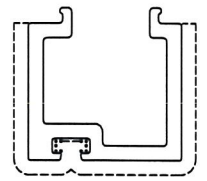

SCALE 1:1

SIGNATURE GRADEING	HIGH SIGNATURE GRADEING	C.C.DIA(MM)	Ø27.94							
AREA (SQ MM)	138.23	UNSPECIFIED THICKNESS	2±0.2	PERIMETER (MM)	141.45	STANDARDX	BS EN755	SCALE	2:1	
MASS (KG/M)	0.375	UNSPECIFIED CORNERS	R 0.3	SURFACE AREA	68.62	ALLOY	6063-T6	VERSION	B	
COMPANY ISSUE		A	DRAWA	蔡晓婷	DATE	2018-08-29	APPELLATION	-	PAGE OF	
			STANDA-RDIZATION		DATE					
			TO SIGN	陈国提	DATE					
			AUDITING		DATE					
MARKER	MODIFY	FILE NO	SIGNATURE	DATE	APPROV	DATE				

PANASIA ALUMINUM (CHINA) LIMITED

CUSTOMER	HONGKONG CO.	CUSTOMER APPROVAL	CUST PART NO.	X85548
			SECTION NO.	LH0089915

M4

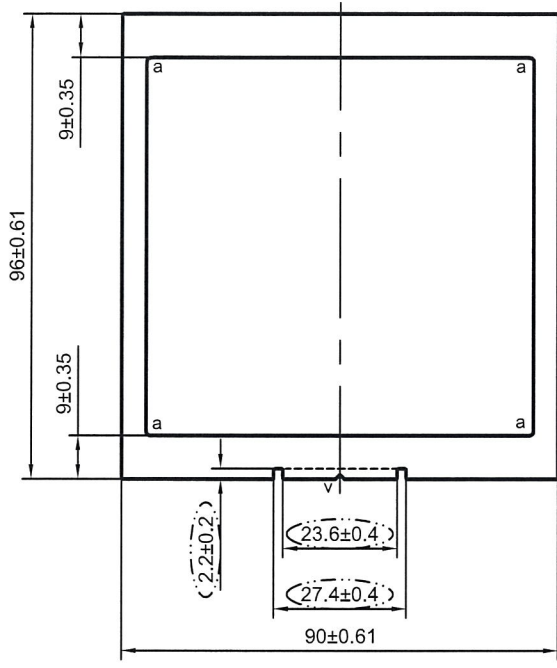

美特鋁質有限公司	
承認圖面	
日期	2018-7-11

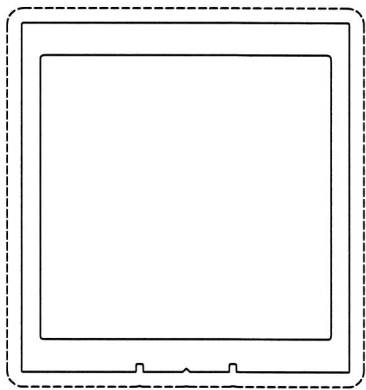
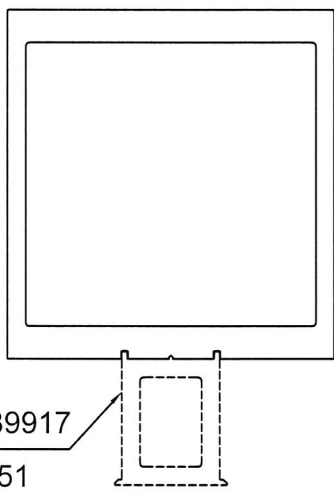
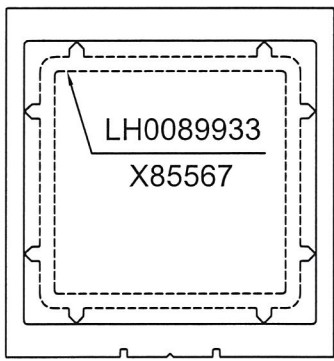

a=R1
v=1XR0.2X90°

LH0089917
X85551
SCALE 1:2

V.F SCALE 1:2

*配合尺寸以实物配合效果为准!

SIGNATURE GRADEING	HIGH SIGNATURE GRADEING	C.C.DIA(MM)	Ø131.34						
AREA (SQ MM)	2391.43	UNSPECIFIED THICKNESS	5±0.35	PERIMETER (MM)	379.98	STANDARD	BS EN755	SCALE	1:1.5
MASS (KG/M)	6.481	UNSPECIFIED CORNERS	R 0.3	SURFACE AREA	379.98	ALLOY	6063-T6	VERSION	C
COMPANY ISSUE		A	DRAWN	蔡晓婷	DATE	2018-09-07	APELLATION	-	PAGE OF
			STANDARDIZATION		DATE				
			TO SIGN	陈国提	DATE				
			AUDITING		DATE				
MARKER	MODIFY	FILE NO	SIGNATURE	DATE	APPROV	DATE			

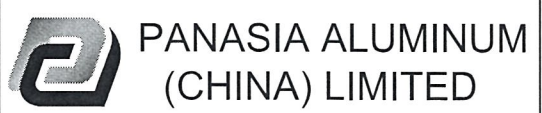

CUSTOMER	HONGKONG CO.	CUSTOMER APPROVAL	CUST PART NO.	X85551
			SECTION NO.	LH0089917

M7

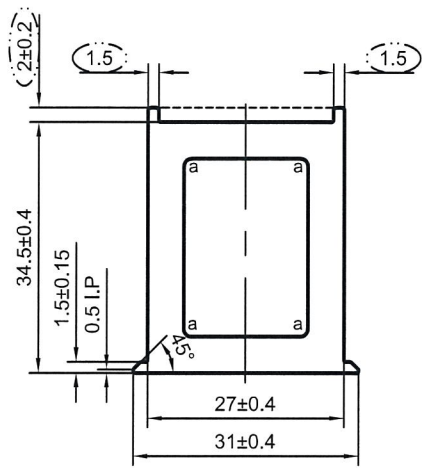

美特鋁質有限公司	
承認圖面	
日期	2018-9-11

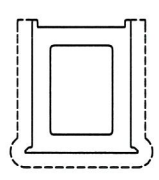

(V.F)
SCALE 1:2

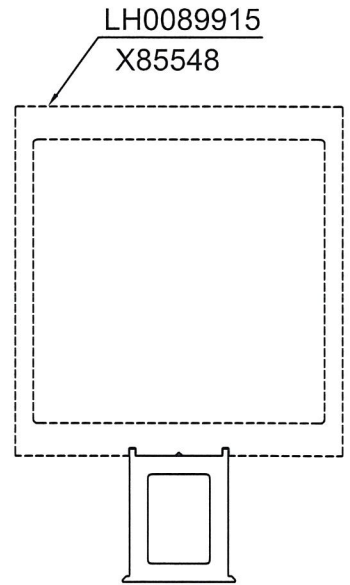

SCALE 1:2

a=R1

*配合尺寸以实物配合效果为准!

SIGNATURE GRADEING	HIGH SIGNATURE GRADEING	C.C.DIA(MM)	Ø46.45		SCALE 1:2				
AREA (SQ MM)	526.81	UNSPECIFIED THICKNESS	5±0.35	PERIMETER (MM)	136.49	STANDARD	BS EN755	SCALE	1:1
MASS (KG/M)	1.428	UNSPECIFIED CORNERS	R 0.3	SURFACE AREA	106.60	ALLOY	6063-T6	VERSION	C
COMPANY ISSUE		A	DRAWA	蔡晓婷	DATE	2018-09-07	APELLATION	-	PAGE OF
			STANDA-RDIZATION		DATE				
			TO SIGN	陈国提	DATE				
			AUDITING		DATE				
MARKER	MODIFY	FILE NO	SIGNATURE	DATE	APPROV				

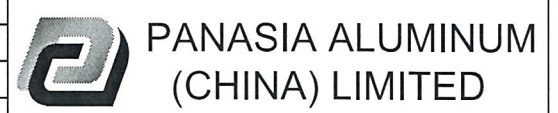

CUSTOMER	HONGKONG CO.	CUSTOMER APPROVAL	CUST PART NO.	X85558
			SECTION NO.	LH0089924

A03

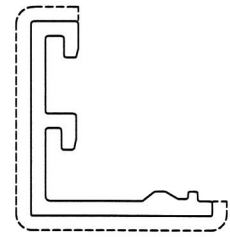
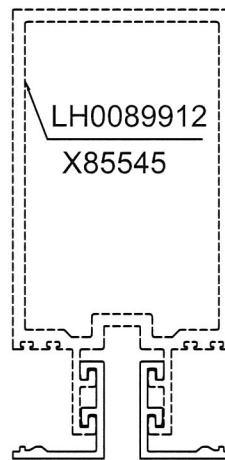
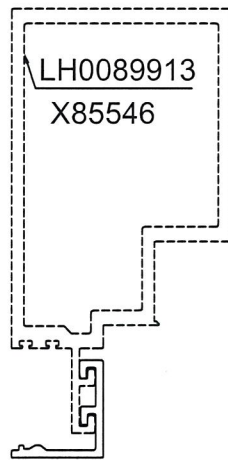
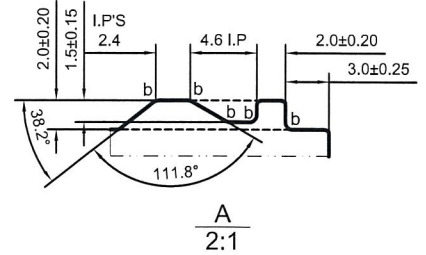
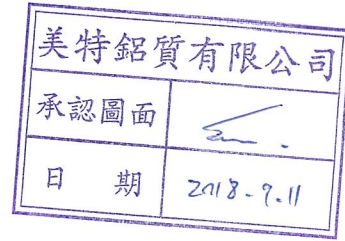
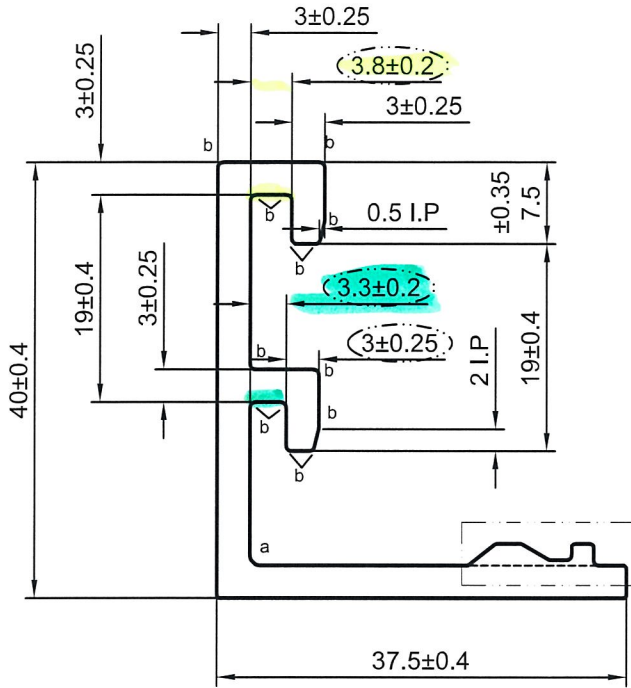

a=R1 b=R0.5

SCALE 1:3

V.F.
SCALE 1:1.5

*配合尺寸以实物配合效果为准!

SIGNATURE GRADEING	HIGH SIGNATURE GRADEING	C.C.DIA(MM)	Ø54.5						
AREA (SQ MM)	304.47	UNSPECIFIED THICKNESS	3±0.25	PERIMETER (MM)	199.01	STANDARDX	BS EN755	SCALE	1.5:1
MASS (KG/M)	0.825	UNSPECIFIED CORNERS	R 0.3	SURFACE AREA	90.28	ALLOY	6063-T6	VERSION	B
COMPANY ISSUE		A	DRAWA	蔡晓婷	DATE	2018-09-07	APPELLATION	-	PAGE 1 OF 2
			STANDA-RDIZATION		DATE				
			TO SIGN	陈国提	DATE				
			AUDITING		DATE				
MARKER	MODIFY	FILE NO	SIGNATURE	DATE	APPROV	DATE			

PANASIA ALUMINUM (CHINA) LIMITED

CUSTOMER	HONGKONG CO.	CUSTOMER APPROVAL	CUST PART NO.	X85558
			SECTION NO.	LH0089924

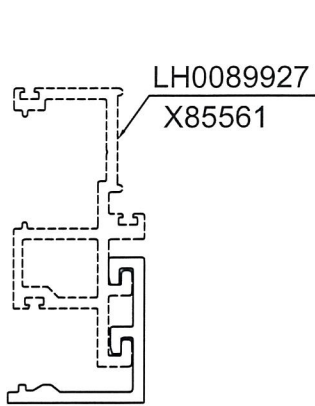

SCALE 1:2

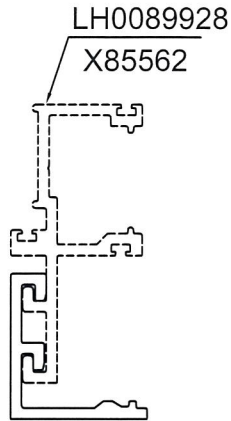

SCALE 1:2

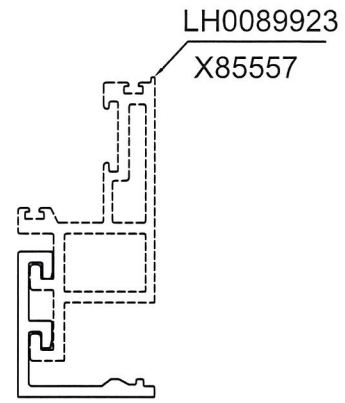

SCALE 1:2

A03

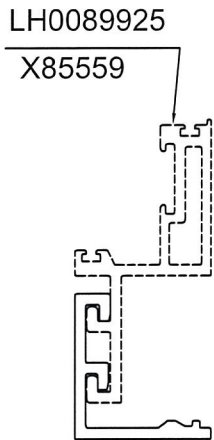

SCALE 1:2

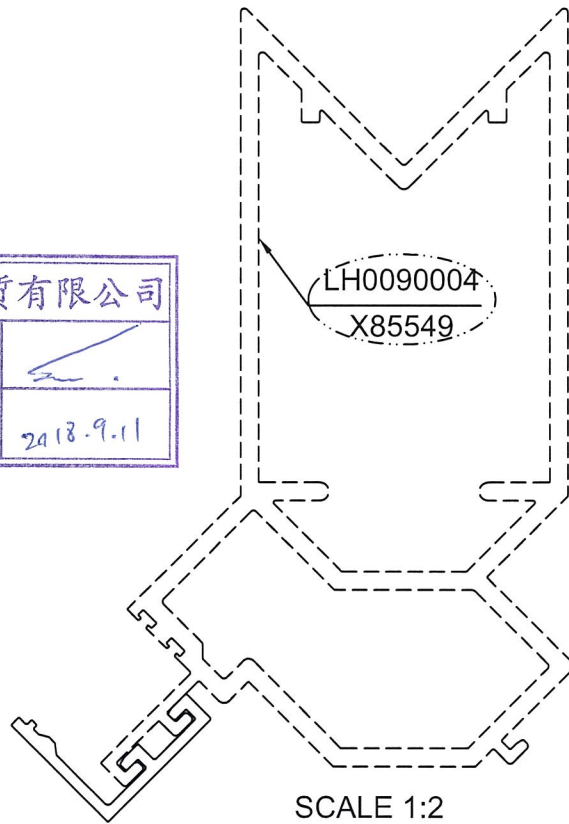
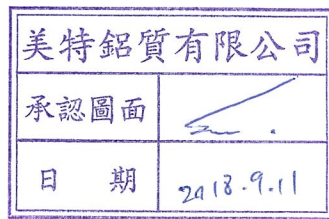

SCALE 1:2

*配合尺寸以实物配合效果为准!

SIGNATURE GRADEING	HIGH SIGNATURE GRADEING	C.C.DIA(MM)	Ø54.5	
AREA (SQ MM)	UNSPECIFIED THICKNESS	3±0.25	PERIMETER (MM)	STANDARDX
MASS (KG/M)	UNSPECIFIED CORNERS	R 0.3	SURFACE AREA	SCALE
COMPANY ISSUE		A	DATE	VERSION
DRAWN		蔡晓婷	DATE	APPELLATION
STANDARDIZATION			DATE	PAGE 2 OF 2
TO SIGN		陈国提	DATE	
AUDITING			DATE	
MARKER	MODIFY FILE NO	SIGNATURE	DATE	
APPROV			DATE	

CUSTOMER	HONGKONG CO.	CUSTOMER APPROVAL	CUST PART NO.	X85569
			SECTION NO.	LH0089934

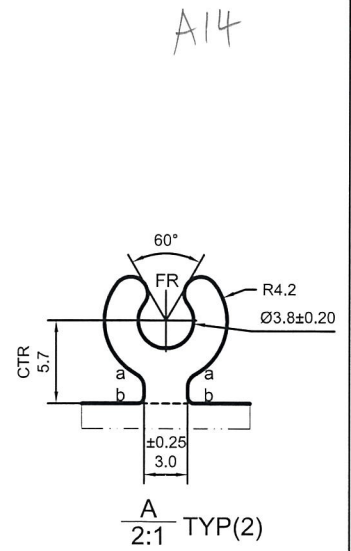
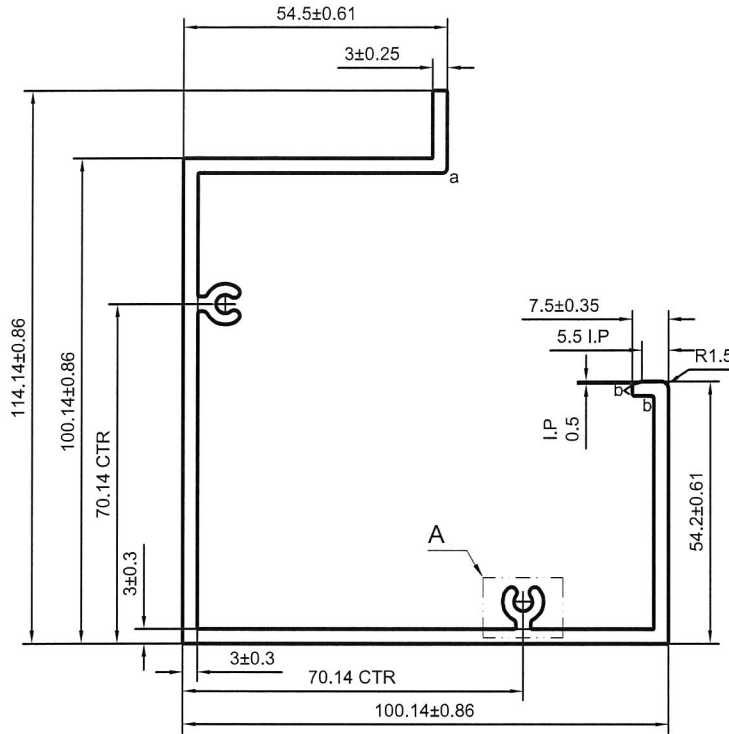

美特鋁質有限公司
承認圖面
日期 2018.9.11

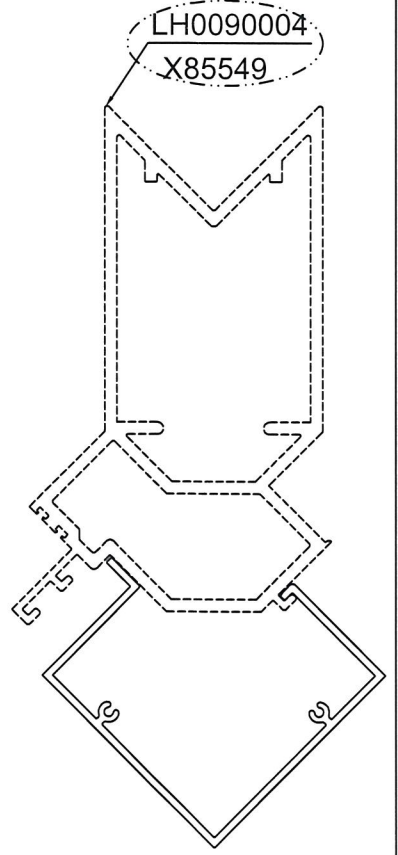

a=R1 b=R0.5

----- 次要裝飾面，噴塗膜厚不足，但不露底
----- 裝飾面

*配合尺寸以实物配合效果为准！

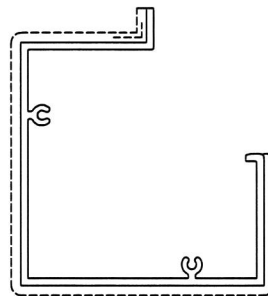

V.F
SCALE 1:3

SIGNATURE GRADEING	HIGH SIGNATURE GRADEING	C.C.DIA(MM)	Ø141.37						
AREA (SQ MM)	1035.15	UNSPECIFIED THICKNESS	3±0.25	PERIMETER (MM)	702.5	STANDARD	BS EN755	SCALE	1:1.5
MASS (KG/M)	2.805	UNSPECIFIED CORNERS	R 0.3	SURFACE AREA	320.49	ALLOY	6063-T6	VERSION	C
COMPANY ISSUE		A	DRAWA	蔡晓婷	DATE	2018-09-07	APPELLATION	-	PAGE OF
			STANDA-RDIZATION		DATE				
			TO SIGN	陈国提	DATE				
			AUDITING		DATE				
MARKER	MODIFY	FILE NO	SIGNATURE	DATE	APPROV				

 PANASIA ALUMINUM (CHINA) LIMITED