



工程指示 / 要求簡箋(E.I.)

工程指示編號：EI/0515/19

修改版次：-

工程編號：J837 平台

工程名稱：觀塘 裕民坊平台

工程項目：廠用玻璃 BM(3/F 內圓位置)

收件人：Maggie

發件人：Leung Hin Wai

日期：30/4 2019

要求提供 / 確認 事項：

- | | | |
|------------------------------------|-------------------------------------|-------------------------------|
| <input type="checkbox"/> 初步鋁料 B.M. | <input type="checkbox"/> 加工拆圖，然後生產 | <input type="checkbox"/> 尺寸表 |
| <input type="checkbox"/> 正式鋁料 B.M. | <input type="checkbox"/> 技術上資料 / 指示 | <input type="checkbox"/> 報價 |
| <input type="checkbox"/> 配件 B.M. | <input type="checkbox"/> 樣辦或貨品說明書 | <input type="checkbox"/> 分判合約 |
| <input type="checkbox"/> 其他：_____ | | |

內容：

請按附頁加工。 玻璃是 12Low Iron Tempered Glass

樣板編號：D18081499

要求玻璃入熱浸爐時間在 2019 年 5 月 30 日以後的時間進行

入爐溫度要有 280 度或以上(此工程是跟舊例)

入爐出爐要有 CCTV 記錄、再以光碟記錄提交

請在 _____ 前完成上列要求。

附：-

1 + 17 頁 (第 11 至 17 頁位置圖)

以上項目為：

- 原合約工程包 原合約工程加 / 減賬 新工程報價

原因：-

分發東莞各部門：

- () 生產技術總監 連附件 () 技術部 連附件 () 生產部 連附件 () 機械設計部 連附件
 () 採購部 連附件 (/) 生產統籌部 連附件
 () 質檢部 連附件 () 會計部 連附件 () 報關組 連附件 () 其他 _____ 連附件

分發香港各部門：

- () 行政部 連附件 () 會計部 連附件 () 統籌部 連附件 () 工程部地盤科文(柄) 連附件
 () 採購部 連附件 () QS 部 連附件 () 維修部 連附件 () 其他 _____ 連附件

傳遞編號：

HR 1015/19

發件人簽署：

項目經理簽署：

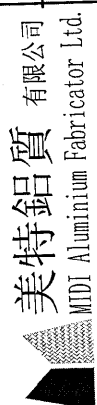

美特鋁質 有限公司
MTDI Aluminium Fabricator Ltd.

廠用玻璃B.M.表

BM編號: _____

修改內容: _____

修改版次: _____

工程號: J-837

地盤名稱: 觀塘平台

項目類別: GLASS WALL

計算: 曾建平

核對: *[Signature]*

批准: _____

日期: 12/4/2019

送呈: 施哥

副本: _____

A/C Code: _____

此BM依據 _____

序號	玻璃圖號	顏色與類型	玻璃尺寸			數量 (塊)	總面積 (平方米)	樓層	備註
			厚度 (mm)	寬度 (mm)	高度 (mm)				
1	J837-GW-G01		12	1298.0	2863.0	4	14.865	3/F	詳見加工圖: J837-GW-GL1
2	J837-GW-G02		12	1453.0	2863.0	2	8.320	3/F	詳見加工圖: J837-GW-GL1
3	J837-GW-G02a		12	1453.0	2712.0	8	31.524	3/F	詳見加工圖: J837-GW-GL1
4	J837-GW-G03		12	645.0	2863.0	20	36.933	3/F	詳見加工圖: J837-GW-GL1
5	J837-GW-G04		12	645.0	2712.0	2	3.498	3/F	詳見加工圖: J837-GW-GL1
6	J837-GW-G05		12	1342.0	2712.0	4	14.558	3/F	詳見加工圖: J837-GW-GL1
7	J837-GW-G06		12	1322.0	2092.0	2	5.531	3/F	詳見加工圖: J837-GW-GL1
8	J837-GW-G06a		12	1322.0	2712.0	2	7.171	3/F	詳見加工圖: J837-GW-GL1
9	J837-GW-G07		12	1485.0	2863.0	3	12.755	3/F	詳見加工圖: J837-GW-GL1
10	J837-GW-G08		12	1146.0	2863.0	4	13.124	3/F	詳見加工圖: J837-GW-GL1
11	J837-GW-G09		12	1377.0	2863.0	3	11.827	3/F	詳見加工圖: J837-GW-GL1
12	J837-GW-G10		12	1485.0	2613.0	3	11.641	3/F	詳見加工圖: J837-GW-GL1
13	J837-GW-G11		12	703.0	2613.0	1	1.837	3/F	詳見加工圖: J837-GW-GL1
14	J837-GW-G12		12	1313.0	2863.0	3	11.277	3/F	詳見加工圖: J837-GW-GL1
15	J837-GW-G14		12	1469.0	2863.0	3	12.617	3/F	詳見加工圖: J837-GW-GL1
16	J837-GW-G15		12	1542.0	2863.0	2	8.829	3/F	詳見加工圖: J837-GW-GL1
17	J837-GW-G16		12	1334.0	2863.0	8	30.554	3/F	詳見加工圖: J837-GW-GL1
18	J837-GW-G17		12	1413.0	1588.0	13	29.170	3/F	詳見加工圖: J837-GW-GL1
19	J837-GW-G18		12	1288.0	2863.0	3	11.063	3/F	詳見加工圖: J837-GW-GL1
20	J837-GW-G19		12	1097.0	2663.0	1	2.921	3/F	詳見加工圖: J837-GW-GL1
21	J837-GW-G20		12	1183.0	2663.0	3	9.451	3/F	詳見加工圖: J837-GW-GL1
22	J837-GW-G21		12	1485.0	2663.0	4	15.818	3/F	詳見加工圖: J837-GW-GL1
23	J837-GW-G22		12	909.0	2663.0	1	2.421	3/F	詳見加工圖: J837-GW-GL1
24	J837-GW-G23		12	1409.0	2663.0	1	3.752	3/F	詳見加工圖: J837-GW-GL1

12mm THK. MONOLITHIC LOW
IRON TEMPERED GLASS

廠用玻璃B.M.表

BM編號:	工程號:	J-837	計算:	曾建平	日期:	12/4/2019	送呈:	施哥
	地盤名稱:	觀塘平台	核對:	<i>[Signature]</i>	日期:	3/4-2019 <th>副本:</th> <td></td>	副本:	
	項目類別:	GLASS WALL	批准:		日期:		A/C Code:	
	修改版次:		總計玻璃面積 (平方米): 572.700			此BM依據		
25	J837-GW-G24	12	495.0	2663.0	2	2.636	3/F	詳見加工圖: J837-GW-GL1
26	J837-GW-G25	12	1137.0	2663.0	1	3.028	3/F	詳見加工圖: J837-GW-GL1
27	J837-GW-G26	12	1225.0	2863.0	4	14.029	3/F	詳見加工圖: J837-GW-GL1
28	J837-GW-G27	12	1361.0	2863.0	10	38.965	3/F	詳見加工圖: J837-GW-GL1
29	J837-GW-G28	12	1466.0	2863.0	10	41.972	3/F	詳見加工圖: J837-GW-GL1
30	J837-GW-G29	12	1457.0	2863.0	1	4.171	3/F	詳見加工圖: J837-GW-GL1
31	J837-GW-G30	12	1443.0	2863.0	1	4.131	3/F	詳見加工圖: J837-GW-GL1
32	J837-GW-G31	12	1460.0	2863.0	4	16.720	3/F	詳見加工圖: J837-GW-GL1
33	J837-GW-G32	12	948.0	2863.0	2	5.428	3/F	詳見加工圖: J837-GW-GL1
34	J837-GW-G33	12	1408.0	2393.0	14	47.171	3/F	詳見加工圖: J837-GW-GL1
35	J837-GW-G34	12	1260.0	2393.0	2	6.030	3/F	詳見加工圖: J837-GW-GL1
36	J837-GW-G35	12	835.0	2393.0	1	1.998	3/F	詳見加工圖: J837-GW-GL1
50	J837-GW-G49	12	260.0	2863.0	1	0.744	3/F	詳見加工圖: J837-GW-GL1
51	J837-GW-G51	12	436.0	2863.0	1	1.248	3/F	詳見加工圖: J837-GW-GL1
52	J837-GW-G52	12	1433.0	2863.0	1	4.103	3/F	詳見加工圖: J837-GW-GL1
53	J837-GW-G53	12	1096.0	2863.0	1	3.138	3/F	詳見加工圖: J837-GW-GL3
54	J837-GW-G54	12	1306.5	2863.0	1	3.741	3/F	詳見加工圖: J837-GW-GL4
55	J837-GW-G53a	12	1464.0	2613.0	1	3.825	3/F	詳見加工圖: J837-GW-GL3
56	J837-GW-G54a	12	1366.0	2613.0	1	3.569	3/F	詳見加工圖: J837-GW-GL4
57	J837-GW-G55	12	1410.0	1588.0	1	2.239	3/F	詳見加工圖: J837-GW-GL3
58	J837-GW-G56	12	468.5	2863.0	1	1.341	3/F	詳見加工圖: J837-GW-GL4
59	J837-GW-G57	12	1281.5	2863.0	1	3.669	3/F	詳見加工圖: J837-GW-GL4
60	J837-GW-G58	12	641.0	2863.0	2	3.670	3/F	詳見加工圖: J837-GW-GL3
61	J837-GW-G59	12	1093.0	2663.0	1	2.911	3/F	詳見加工圖: J837-GW-GL4
62	J837-GW-G60	12	1133.0	2663.0	1	3.017	3/F	詳見加工圖: J837-GW-GL3

12mm THK. MONOLITHIC LOW
IRON TEMPERED GLASS

工程號: J-837		日期: 12/4/2019		送呈: 施哥				
地盤名稱: 觀塘平台		日期: 30/4-2019		副本:				
項目類別: GLASS WALL		日期:		A/C Code:				
修改版次:		572.700		此BM依據				
BM編號:	總計玻璃面積 (平方米):							
63	J837-GW-G61	12	1221.0	2863.0	1	3.496	3/F	詳見加工圖: J837-GW-GL4
64	J837-GW-G62	12	1366.5	2863.0	1	3.912	3/F	詳見加工圖: J837-GW-GL3
65	J837-GW-G63	12	1359.0	2863.0	1	3.891	3/F	詳見加工圖: J837-GW-GL4
66	J837-GW-G63a	12	1453.0	2863.0	1	4.160	3/F	詳見加工圖: J837-GW-GL4
67	J837-GW-G64	12	1439.0	2863.0	1	4.120	3/F	詳見加工圖: J837-GW-GL3
68	J837-GW-G65	12	1456.0	2863.0	1	4.169	3/F	詳見加工圖: J837-GW-GL4
69	J837-GW-G66	12	256.0	2863.0	1	0.733	3/F	詳見加工圖: J837-GW-GL3
70	J837-GW-G67	12	1404.0	2393.0	1	3.360	3/F	詳見加工圖: J837-GW-GL4
71	J837-GW-G68	12	797.0	2393.0	1	1.907	3/F	詳見加工圖: J837-GW-GL3
72	J837-GW-G69	12	1256.0	2393.0	1	3.006	3/F	詳見加工圖: J837-GW-GL4
73	J837-GW-G70	12	1256.0	2393.0	1	3.006	3/F	詳見加工圖: J837-GW-GL3
74	J837-GW-G71	12	831.0	2393.0	1	1.989	3/F	詳見加工圖: J837-GW-GL4
				合計	178	572.700		
12mm THK. MONOLITHIC LOW IRON TEMPERED GLASS								
<p>1).本表中所採用之玻璃樣板編號 D180 81499</p> <p>2).本表中所有玻璃對角線尺寸偏差要求不超過正負2mm。</p> <p>3).本表中所有玻璃要求粗磨邊處理並倒稜角。</p> <p>4).本表中不同種類玻璃參照玻璃加工圖加工。</p> <p>5).本表中所有強化玻璃均需HEAT SOAK TEST。</p> <p>6).本表中所有強化玻璃之入爐方向均以寬度方向進入。</p> <p>7).本表中所有玻璃成品送交東莞美而特廠，每次交貨時須齊層、齊款、齊數量，每次來貨之具體數量由美而特廠生產統籌部提供。</p> <p>8).本表中所有玻璃成品均需注明室內外面及其玻璃編號，以便識別。</p>								
加工注意事項:								

美特鋁質有限公司 MIDI Aluminium Fabricator Ltd.		工程號: J-837	計算:	黃漢卿	日期:	12/4/2019	送呈:	施哥
廠用玻璃B.M.表		地盤名稱: 觀塘平台 <td>核對:</td> <td></td> <td>日期:</td> <td></td> <td>副本:</td> <td></td>	核對:		日期:		副本:	
BM編號:		項目類別: GLASS WALL <td>批准:</td> <td></td> <td>日期:</td> <td></td> <td>A/C Code:</td> <td></td>	批准:		日期:		A/C Code:	
修改版次:		總計玻璃面積 (平方米):		572.700		此BM依據		
25	J837-GW-G24	12	495.0	2663.0	2	2.636	3/F	詳見加工圖: J837-GW-GL1
26	J837-GW-G25	12	1137.0	2663.0	1	3.028	3/F	詳見加工圖: J837-GW-GL1
27	J837-GW-G26	12	1225.0	2863.0	4	14.029	3/F	詳見加工圖: J837-GW-GL1
28	J837-GW-G27	12	1361.0	2863.0	10	38.965	3/F	詳見加工圖: J837-GW-GL1
29	J837-GW-G28	12	1466.0	2863.0	10	41.972	3/F	詳見加工圖: J837-GW-GL1
30	J837-GW-G29	12	1457.0	2863.0	1	4.171	3/F	詳見加工圖: J837-GW-GL1
31	J837-GW-G30	12	1443.0	2863.0	1	4.131	3/F	詳見加工圖: J837-GW-GL1
32	J837-GW-G31	12	1460.0	2863.0	4	16.720	3/F	詳見加工圖: J837-GW-GL1
33	J837-GW-G32	12	948.0	2863.0	2	5.428	3/F	詳見加工圖: J837-GW-GL1
34	J837-GW-G33	12	1408.0	2393.0	14	47.171	3/F	詳見加工圖: J837-GW-GL1
35	J837-GW-G34	12	1260.0	2393.0	2	6.030	3/F	詳見加工圖: J837-GW-GL1
36	J837-GW-G35	12	835.0	2393.0	1	1.998	3/F	詳見加工圖: J837-GW-GL1
50	J837-GW-G49	12	260.0	2863.0	1	0.744	3/F	詳見加工圖: J837-GW-GL1
51	J837-GW-G51	12	436.0	2863.0	1	1.248	3/F	詳見加工圖: J837-GW-GL1
52	J837-GW-G52	12	1433.0	2863.0	1	4.103	3/F	詳見加工圖: J837-GW-GL1
53	J837-GW-G53	12	1096.0	2863.0	1	3.138	3/F	詳見加工圖: J837-GW-GL3
54	J837-GW-G54	12	1306.5	2863.0	1	3.741	3/F	詳見加工圖: J837-GW-GL4
55	J837-GW-G53a	12	1464.0	2613.0	1	3.825	3/F	詳見加工圖: J837-GW-GL3
56	J837-GW-G54a	12	1366.0	2613.0	1	3.569	3/F	詳見加工圖: J837-GW-GL4
57	J837-GW-G55	12	1410.0	1588.0	1	2.239	3/F	詳見加工圖: J837-GW-GL3
58	J837-GW-G56	12	468.5	2863.0	1	1.341	3/F	詳見加工圖: J837-GW-GL4
59	J837-GW-G57	12	1281.5	2863.0	1	3.669	3/F	詳見加工圖: J837-GW-GL4
60	J837-GW-G58	12	641.0	2863.0	2	3.670	3/F	詳見加工圖: J837-GW-GL3
61	J837-GW-G59	12	1093.0	2663.0	1	2.911	3/F	詳見加工圖: J837-GW-GL4
62	J837-GW-G60	12	1133.0	2663.0	1	3.017	3/F	詳見加工圖: J837-GW-GL3

此列只供參考

12mm THK. MONOLITHIC LOW
IRON TEMPERED GLASS

廠用玻璃B.M.表

BM編號:	工程號:	J-837	計算:	黃漢卿	日期:	12/4/2019	送呈:	施哥
	地盤名稱:	觀塘平台	核對:		日期:		副本:	
	項目類別:	GLASS WALL	批准:		日期:		A/C Code:	
	修改版次:		總計玻璃面積 (平方米):		572.700	此BM依據		
63	J837-GW-G61	12	1221.0	2863.0	1	3.496	3/F	詳見加工圖: J837-GW-GL4
64	J837-GW-G62	12	1366.5	2863.0	1	3.912	3/F	詳見加工圖: J837-GW-GL3
65	J837-GW-G63	12	1359.0	2863.0	1	3.891	3/F	詳見加工圖: J837-GW-GL4
66	J837-GW-G63a	12	1453.0	2863.0	1	4.160	3/F	詳見加工圖: J837-GW-GL4
67	J837-GW-G64	12	1439.0	2863.0	1	4.120	3/F	詳見加工圖: J837-GW-GL3
68	J837-GW-G65	12	1456.0	2863.0	1	4.169	3/F	詳見加工圖: J837-GW-GL4
69	J837-GW-G66	12	256.0	2863.0	1	0.733	3/F	詳見加工圖: J837-GW-GL3
70	J837-GW-G67	12	1404.0	2393.0	1	3.360	3/F	詳見加工圖: J837-GW-GL4
71	J837-GW-G68	12	797.0	2393.0	1	1.907	3/F	詳見加工圖: J837-GW-GL3
72	J837-GW-G69	12	1256.0	2393.0	1	3.006	3/F	詳見加工圖: J837-GW-GL4
73	J837-GW-G70	12	1256.0	2393.0	1	3.006	3/F	詳見加工圖: J837-GW-GL3
74	J837-GW-G71	12	831.0	2393.0	1	1.989	3/F	詳見加工圖: J837-GW-GL4
				合計	178	572.700		

此BM只供參考

12mm THK. MONOLITHIC LOW IRON TEMPERED GLASS

- 1). 本表中所採用之玻璃為信義玻璃廠出品之玻璃原片
- 2). 本表中所有玻璃對角線尺寸偏差要求不超過正負2mm。
- 3). 本表中所有玻璃要求粗磨邊處理並倒棱角。
- 4). 本表中不同種類玻璃參照玻璃加工圖加工。
- 5). 本表中所有強化玻璃均需HEAT SOAK TEST。
- 6). 本表中所有強化玻璃之人爐方向均以寬度方向進入。
- 7). 本表中所有玻璃成品送交東莞美而特廠，每次交貨時須齊層、齊款、齊數量，每次來貨之具體數量由美而特廠生產統籌部提供。
- 8). 本表中所有玻璃成品均需注明室內外面及其玻璃編號，以便識別。

加工注意事項:

EG-DWG3



美特鋁質 有限公司
MIDI Aluminium Fabricator Ltd.

工程號	J-837	地盤	觀塘平台
-----	-------	----	------

詳細數據見圖紙：J837-GW-GL2

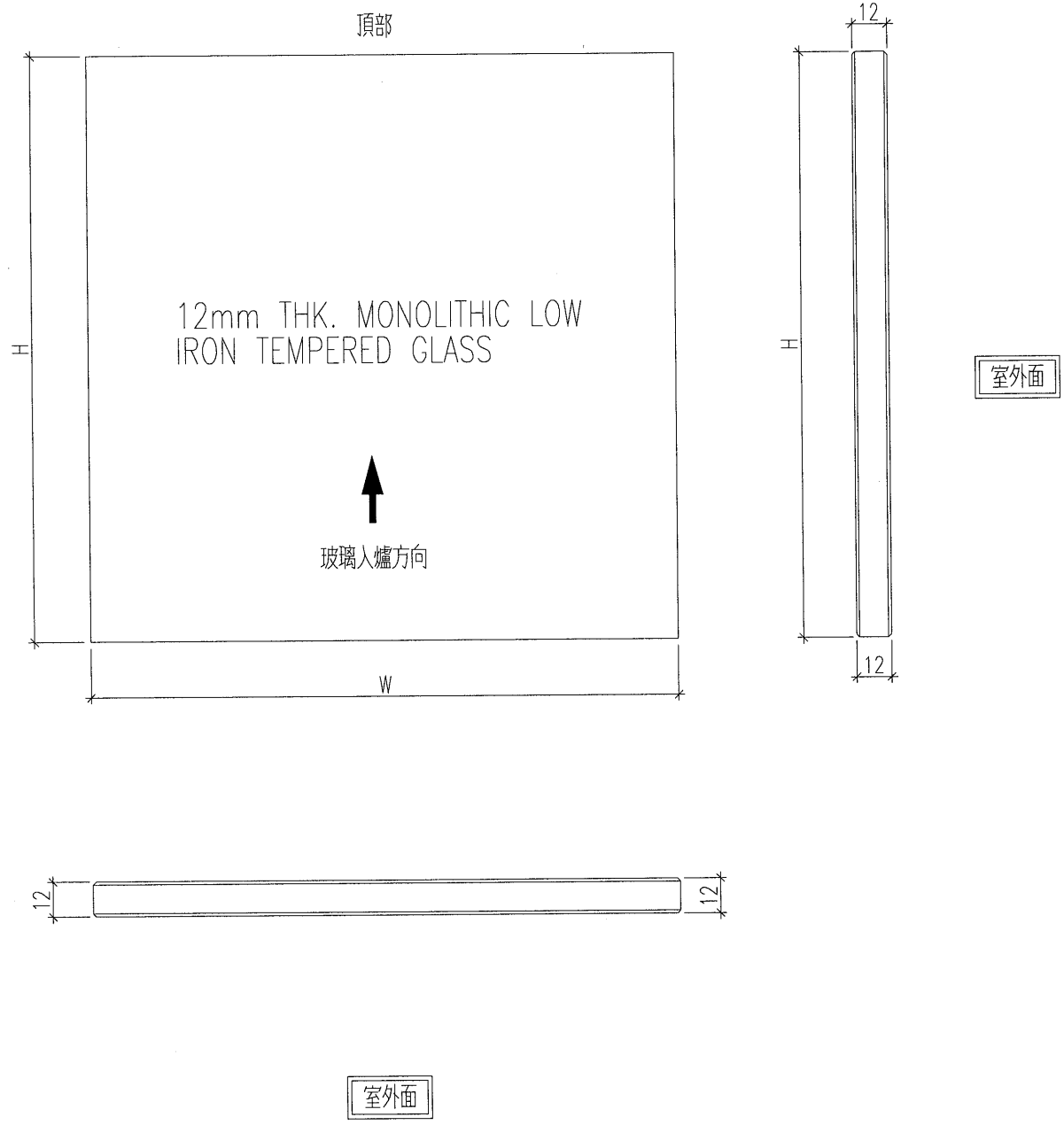

名稱	玻璃加工圖	制圖	曾建平	2018.09.06	修改			
材料		復核	<i>LP</i>	20/9	日期			
顏色		批准			圖號	J837-GW-GL1		



美特鋁質 有限公司
MIDI Aluminium Fabricator Ltd.

工程號 J-836 地盤 日出康城

玻璃圖號	玻璃尺寸		數量 (塊)	玻璃圖號	玻璃尺寸		數量 (塊)
	W (mm)	H (mm)			W (mm)	H (mm)	
J837-GW-G01	1298.0	2863.0	4	J837-GW-G30	1443.0	2863.0	1
J837-GW-G02	1453.0	2863.0	2	J837-GW-G31	1460.0	2863.0	4
J837-GW-G02a	1453.0	2712.0	8	J837-GW-G32	948.0	2863.0	2
J837-GW-G03	645.0	2863.0	20	J837-GW-G33	1408.0	2393.0	14
J837-GW-G04	645.0	2712.0	2	J837-GW-G34	1260.0	2393.0	2
J837-GW-G05	1342.0	2712.0	4	J837-GW-G35	835.0	2393.0	1
J837-GW-G06	1322.0	2092.0	2	J837-GW-G49	260.0	2863.0	1
J837-GW-G06a	1322.0	2712.0	2	J837-GW-G51	436.0	2863.0	1
J837-GW-G07	1485.0	2863.0	3	J837-GW-G52	1433.0	2863.0	1
J837-GW-G08	1146.0	2863.0	4				
J837-GW-G09	1377.0	2863.0	3				
J837-GW-G10	1485.0	2613.0	3				
J837-GW-G11	703.0	2613.0	1				
J837-GW-G12	1313.0	2863.0	3				
J837-GW-G14	1469.0	2863.0	3				
J837-GW-G15	1542.0	2863.0	2				
J837-GW-G16	1334.0	2863.0	8				
J837-GW-G17	1413.0	1588.0	13				
J837-GW-G18	1288.0	2863.0	3				
J837-GW-G19	1097.0	2663.0	1				
J837-GW-G20	1183.0	2663.0	3				
J837-GW-G21	1485.0	2663.0	4				
J837-GW-G22	909.0	2663.0	1				
J837-GW-G23	1409.0	2663.0	1				
J837-GW-G24	495.0	2663.0	2				
J837-GW-G25	1137.0	2663.0	1				
J837-GW-G26	1225.0	2863.0	4				
J837-GW-G27	1361.0	2863.0	10				
J837-GW-G28	1466.0	2863.0	10				
J837-GW-G29	1457.0	2863.0	1				

玻璃加工圖紙見：J837-GW-GL1

名稱	玻璃加工圖	制圖	曾建平	2018.09.06	修改			
材料		復核	許	3/9	日期			
顏色		批准			圖號	J837-GW-GL2		

EG-DWG3

 美特鋁質 有限公司
MIDI Aluminium Fabricator Ltd.

工程號	J-837	地盤	觀塘平台
-----	-------	----	------

玻璃圖號	玻璃尺寸		數量 (塊)
	W (mm)	H (mm)	
J837-GW-G53	1096.0	2863.0	1
J837-GW-G53a	1464.0	2613.0	1
J837-GW-G55	1410.0	1588.0	1
J837-GW-G58	641.0	2863.0	2
J837-GW-G60	1133.0	2663.0	1
J837-GW-G62	1366.5	2863.0	1
J837-GW-G64	1439.0	2863.0	1
J837-GW-G66	256.0	2863.0	1
J837-GW-G68	797.0	2393.0	1
J837-GW-G70	1256.0	2393.0	1

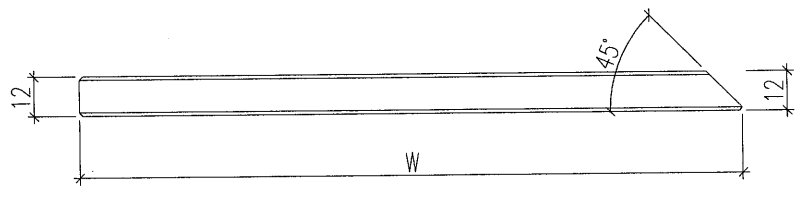
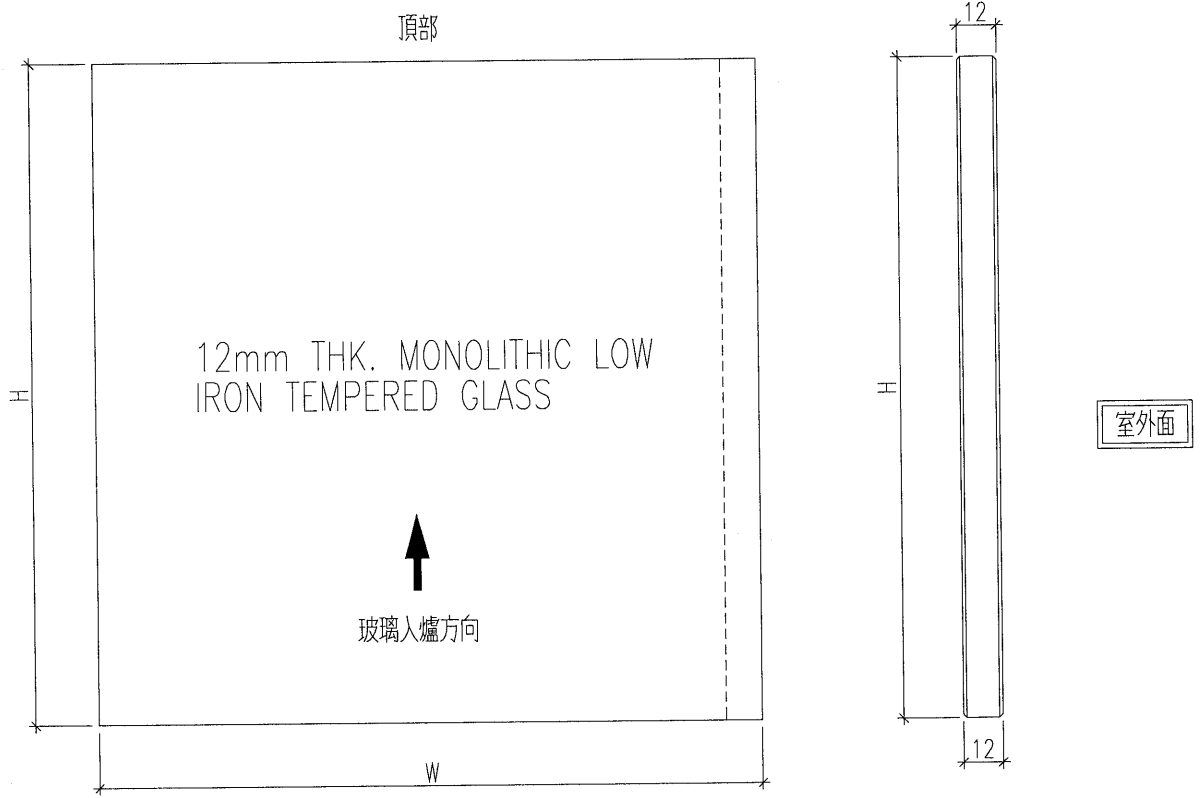

室外面

名稱	玻璃加工圖	制圖	曾建平	2018.09.06	修改		
材料		復核		7/9/4	日期		
顏色		批准			圖號	J837-GW-GL3	

EG-DWG3



美特鋁質 有限公司
MIDI Aluminium Fabricator Ltd.

工程號 J-837 地盤 觀塘平台

玻璃圖號	玻璃尺寸		數量 (塊)
	W (mm)	H (mm)	
J837-GW-G54	1306.5	2863.0	1
J837-GW-G54a	1366.0	2613.0	1
J837-GW-G56	468.5	2863.0	1
J837-GW-G57	1281.5	2863.0	1
J837-GW-G59	1093.0	2663.0	1
J837-GW-G61	1221.0	2863.0	1
J837-GW-G63	1359.0	2863.0	1
J837-GW-G63a	1453.0	2863.0	1
J837-GW-G65	1456.0	2863.0	1
J837-GW-G67	1404.0	2393.0	1
J837-GW-G69	1256.0	2393.0	1
J837-GW-G71	831.0	2393.0	1

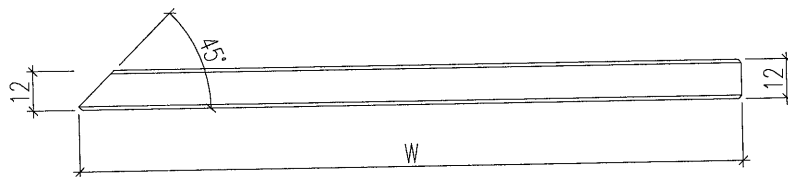
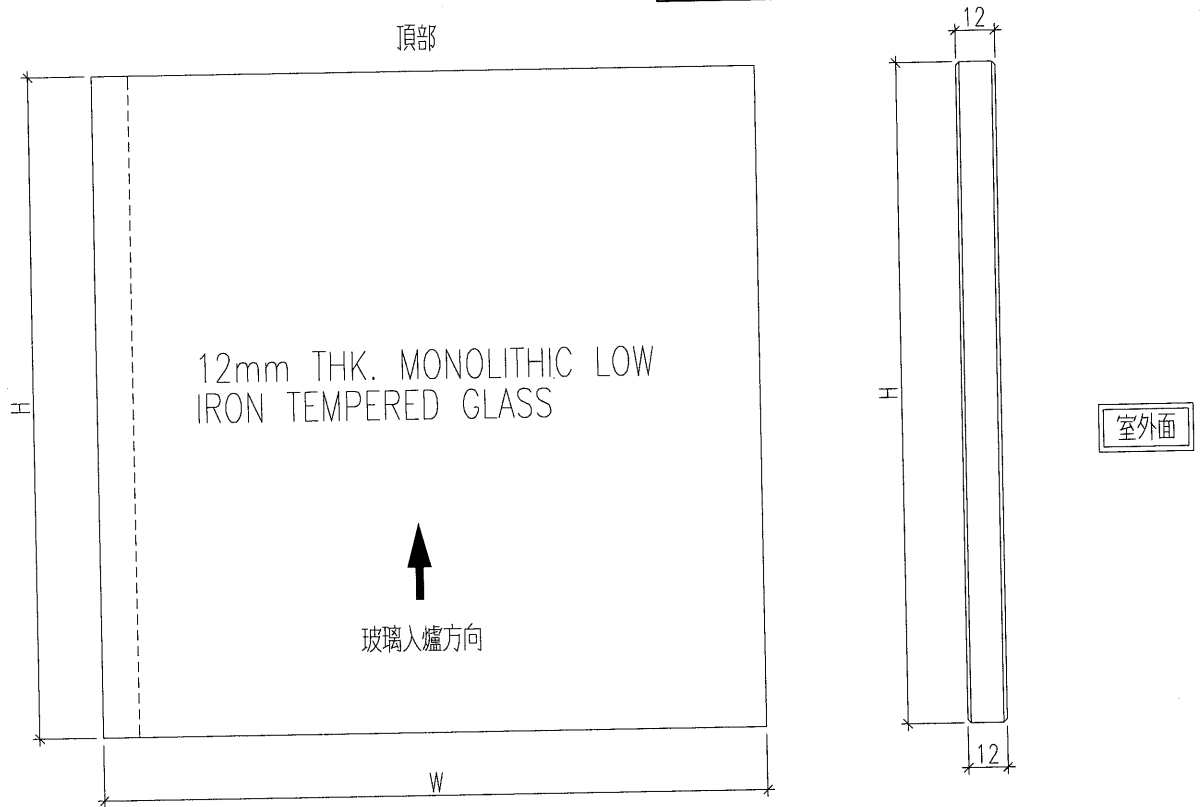

室外面

名稱	玻璃加工圖	制圖	曾建平	2018.09.06	修改			
材料		復核	印	30/4	日期			
顏色		批准			圖號	J837-GW-GL4		

EG-DWG3

美特鋁質 有限公司
MIDI Aluminium Fabricator Ltd.

工程號 J837 地盤 觀塘

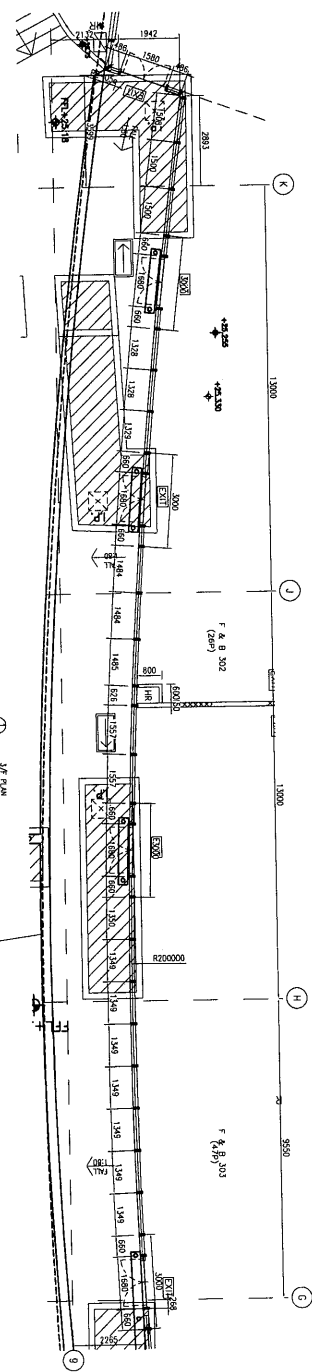

LEGEND:

- EQ1-02 12mm THK MONOCLINIC LOW IRON TEmPERED GLASS
- 14E-01 ALUMINUM MULLION
- 14E-03 ALUMINUM TRANSOM
- 14E-04 ALUMINUM TRANSOM
- 19-01 1200x2000mm THK. G.M.S. RIS
- 19-02 1200x2000mm THK. G.M.S. RIS
- 19-03 1200x2000mm THK. G.M.S. RIS
- 19-04 1200x2000mm THK. G.M.S. RIS
- 19-05 1200x2000mm THK. G.M.S. RIS
- 19-06 1200x2000mm THK. G.M.S. RIS
- 19-07 1200x2000mm THK. G.M.S. RIS
- 19-08 1200x2000mm THK. G.M.S. RIS
- 19-09 1200x2000mm THK. G.M.S. RIS
- 19-10 1200x2000mm THK. G.M.S. RIS
- 19-11 1200x2000mm THK. G.M.S. RIS
- 19-12 1200x2000mm THK. G.M.S. RIS
- 19-13 1200x2000mm THK. G.M.S. RIS
- 19-14 1200x2000mm THK. G.M.S. RIS
- 19-15 1200x2000mm THK. G.M.S. RIS
- 19-16 1200x2000mm THK. G.M.S. RIS
- 19-17 1200x2000mm THK. G.M.S. RIS
- 19-18 1200x2000mm THK. G.M.S. RIS
- 19-19 1200x2000mm THK. G.M.S. RIS
- 19-20 1200x2000mm THK. G.M.S. RIS
- 19-21 1200x2000mm THK. G.M.S. RIS
- 19-22 1200x2000mm THK. G.M.S. RIS
- 19-23 1200x2000mm THK. G.M.S. RIS
- 19-24 1200x2000mm THK. G.M.S. RIS
- 19-25 1200x2000mm THK. G.M.S. RIS
- 19-26 1200x2000mm THK. G.M.S. RIS
- 19-27 1200x2000mm THK. G.M.S. RIS
- 19-28 1200x2000mm THK. G.M.S. RIS
- 19-29 1200x2000mm THK. G.M.S. RIS
- 19-30 1200x2000mm THK. G.M.S. RIS
- 19-31 1200x2000mm THK. G.M.S. RIS
- 19-32 1200x2000mm THK. G.M.S. RIS
- 19-33 1200x2000mm THK. G.M.S. RIS
- 19-34 1200x2000mm THK. G.M.S. RIS
- 19-35 1200x2000mm THK. G.M.S. RIS
- 19-36 1200x2000mm THK. G.M.S. RIS
- 19-37 1200x2000mm THK. G.M.S. RIS
- 19-38 1200x2000mm THK. G.M.S. RIS
- 19-39 1200x2000mm THK. G.M.S. RIS
- 19-40 1200x2000mm THK. G.M.S. RIS
- 19-41 1200x2000mm THK. G.M.S. RIS
- 19-42 1200x2000mm THK. G.M.S. RIS
- 19-43 1200x2000mm THK. G.M.S. RIS
- 19-44 1200x2000mm THK. G.M.S. RIS
- 19-45 1200x2000mm THK. G.M.S. RIS
- 19-46 1200x2000mm THK. G.M.S. RIS
- 19-47 1200x2000mm THK. G.M.S. RIS
- 19-48 1200x2000mm THK. G.M.S. RIS
- 19-49 1200x2000mm THK. G.M.S. RIS
- 19-50 1200x2000mm THK. G.M.S. RIS
- 19-51 1200x2000mm THK. G.M.S. RIS
- 19-52 1200x2000mm THK. G.M.S. RIS
- 19-53 1200x2000mm THK. G.M.S. RIS
- 19-54 1200x2000mm THK. G.M.S. RIS
- 19-55 1200x2000mm THK. G.M.S. RIS
- 19-56 1200x2000mm THK. G.M.S. RIS
- 19-57 1200x2000mm THK. G.M.S. RIS
- 19-58 1200x2000mm THK. G.M.S. RIS
- 19-59 1200x2000mm THK. G.M.S. RIS
- 19-60 1200x2000mm THK. G.M.S. RIS
- 19-61 1200x2000mm THK. G.M.S. RIS
- 19-62 1200x2000mm THK. G.M.S. RIS
- 19-63 1200x2000mm THK. G.M.S. RIS
- 19-64 1200x2000mm THK. G.M.S. RIS
- 19-65 1200x2000mm THK. G.M.S. RIS
- 19-66 1200x2000mm THK. G.M.S. RIS
- 19-67 1200x2000mm THK. G.M.S. RIS
- 19-68 1200x2000mm THK. G.M.S. RIS
- 19-69 1200x2000mm THK. G.M.S. RIS
- 19-70 1200x2000mm THK. G.M.S. RIS
- 19-71 1200x2000mm THK. G.M.S. RIS
- 19-72 1200x2000mm THK. G.M.S. RIS
- 19-73 1200x2000mm THK. G.M.S. RIS
- 19-74 1200x2000mm THK. G.M.S. RIS
- 19-75 1200x2000mm THK. G.M.S. RIS
- 19-76 1200x2000mm THK. G.M.S. RIS
- 19-77 1200x2000mm THK. G.M.S. RIS
- 19-78 1200x2000mm THK. G.M.S. RIS
- 19-79 1200x2000mm THK. G.M.S. RIS
- 19-80 1200x2000mm THK. G.M.S. RIS
- 19-81 1200x2000mm THK. G.M.S. RIS
- 19-82 1200x2000mm THK. G.M.S. RIS
- 19-83 1200x2000mm THK. G.M.S. RIS
- 19-84 1200x2000mm THK. G.M.S. RIS
- 19-85 1200x2000mm THK. G.M.S. RIS
- 19-86 1200x2000mm THK. G.M.S. RIS
- 19-87 1200x2000mm THK. G.M.S. RIS
- 19-88 1200x2000mm THK. G.M.S. RIS
- 19-89 1200x2000mm THK. G.M.S. RIS
- 19-90 1200x2000mm THK. G.M.S. RIS
- 19-91 1200x2000mm THK. G.M.S. RIS
- 19-92 1200x2000mm THK. G.M.S. RIS
- 19-93 1200x2000mm THK. G.M.S. RIS
- 19-94 1200x2000mm THK. G.M.S. RIS
- 19-95 1200x2000mm THK. G.M.S. RIS
- 19-96 1200x2000mm THK. G.M.S. RIS
- 19-97 1200x2000mm THK. G.M.S. RIS
- 19-98 1200x2000mm THK. G.M.S. RIS
- 19-99 1200x2000mm THK. G.M.S. RIS
- 19-100 1200x2000mm THK. G.M.S. RIS

SUPPORT LEGEND:

- EQ1-02 12mm THK MONOCLINIC LOW IRON TEmPERED GLASS
- 14E-01 ALUMINUM MULLION
- 14E-03 ALUMINUM TRANSOM
- 14E-04 ALUMINUM TRANSOM
- 19-01 1200x2000mm THK. G.M.S. RIS
- 19-02 1200x2000mm THK. G.M.S. RIS
- 19-03 1200x2000mm THK. G.M.S. RIS
- 19-04 1200x2000mm THK. G.M.S. RIS
- 19-05 1200x2000mm THK. G.M.S. RIS
- 19-06 1200x2000mm THK. G.M.S. RIS
- 19-07 1200x2000mm THK. G.M.S. RIS
- 19-08 1200x2000mm THK. G.M.S. RIS
- 19-09 1200x2000mm THK. G.M.S. RIS
- 19-10 1200x2000mm THK. G.M.S. RIS
- 19-11 1200x2000mm THK. G.M.S. RIS
- 19-12 1200x2000mm THK. G.M.S. RIS
- 19-13 1200x2000mm THK. G.M.S. RIS
- 19-14 1200x2000mm THK. G.M.S. RIS
- 19-15 1200x2000mm THK. G.M.S. RIS
- 19-16 1200x2000mm THK. G.M.S. RIS
- 19-17 1200x2000mm THK. G.M.S. RIS
- 19-18 1200x2000mm THK. G.M.S. RIS
- 19-19 1200x2000mm THK. G.M.S. RIS
- 19-20 1200x2000mm THK. G.M.S. RIS
- 19-21 1200x2000mm THK. G.M.S. RIS
- 19-22 1200x2000mm THK. G.M.S. RIS
- 19-23 1200x2000mm THK. G.M.S. RIS
- 19-24 1200x2000mm THK. G.M.S. RIS
- 19-25 1200x2000mm THK. G.M.S. RIS
- 19-26 1200x2000mm THK. G.M.S. RIS
- 19-27 1200x2000mm THK. G.M.S. RIS
- 19-28 1200x2000mm THK. G.M.S. RIS
- 19-29 1200x2000mm THK. G.M.S. RIS
- 19-30 1200x2000mm THK. G.M.S. RIS
- 19-31 1200x2000mm THK. G.M.S. RIS
- 19-32 1200x2000mm THK. G.M.S. RIS
- 19-33 1200x2000mm THK. G.M.S. RIS
- 19-34 1200x2000mm THK. G.M.S. RIS
- 19-35 1200x2000mm THK. G.M.S. RIS
- 19-36 1200x2000mm THK. G.M.S. RIS
- 19-37 1200x2000mm THK. G.M.S. RIS
- 19-38 1200x2000mm THK. G.M.S. RIS
- 19-39 1200x2000mm THK. G.M.S. RIS
- 19-40 1200x2000mm THK. G.M.S. RIS
- 19-41 1200x2000mm THK. G.M.S. RIS
- 19-42 1200x2000mm THK. G.M.S. RIS
- 19-43 1200x2000mm THK. G.M.S. RIS
- 19-44 1200x2000mm THK. G.M.S. RIS
- 19-45 1200x2000mm THK. G.M.S. RIS
- 19-46 1200x2000mm THK. G.M.S. RIS
- 19-47 1200x2000mm THK. G.M.S. RIS
- 19-48 1200x2000mm THK. G.M.S. RIS
- 19-49 1200x2000mm THK. G.M.S. RIS
- 19-50 1200x2000mm THK. G.M.S. RIS
- 19-51 1200x2000mm THK. G.M.S. RIS
- 19-52 1200x2000mm THK. G.M.S. RIS
- 19-53 1200x2000mm THK. G.M.S. RIS
- 19-54 1200x2000mm THK. G.M.S. RIS
- 19-55 1200x2000mm THK. G.M.S. RIS
- 19-56 1200x2000mm THK. G.M.S. RIS
- 19-57 1200x2000mm THK. G.M.S. RIS
- 19-58 1200x2000mm THK. G.M.S. RIS
- 19-59 1200x2000mm THK. G.M.S. RIS
- 19-60 1200x2000mm THK. G.M.S. RIS
- 19-61 1200x2000mm THK. G.M.S. RIS
- 19-62 1200x2000mm THK. G.M.S. RIS
- 19-63 1200x2000mm THK. G.M.S. RIS
- 19-64 1200x2000mm THK. G.M.S. RIS
- 19-65 1200x2000mm THK. G.M.S. RIS
- 19-66 1200x2000mm THK. G.M.S. RIS
- 19-67 1200x2000mm THK. G.M.S. RIS
- 19-68 1200x2000mm THK. G.M.S. RIS
- 19-69 1200x2000mm THK. G.M.S. RIS
- 19-70 1200x2000mm THK. G.M.S. RIS
- 19-71 1200x2000mm THK. G.M.S. RIS
- 19-72 1200x2000mm THK. G.M.S. RIS
- 19-73 1200x2000mm THK. G.M.S. RIS
- 19-74 1200x2000mm THK. G.M.S. RIS
- 19-75 1200x2000mm THK. G.M.S. RIS
- 19-76 1200x2000mm THK. G.M.S. RIS
- 19-77 1200x2000mm THK. G.M.S. RIS
- 19-78 1200x2000mm THK. G.M.S. RIS
- 19-79 1200x2000mm THK. G.M.S. RIS
- 19-80 1200x2000mm THK. G.M.S. RIS
- 19-81 1200x2000mm THK. G.M.S. RIS
- 19-82 1200x2000mm THK. G.M.S. RIS
- 19-83 1200x2000mm THK. G.M.S. RIS
- 19-84 1200x2000mm THK. G.M.S. RIS
- 19-85 1200x2000mm THK. G.M.S. RIS
- 19-86 1200x2000mm THK. G.M.S. RIS
- 19-87 1200x2000mm THK. G.M.S. RIS
- 19-88 1200x2000mm THK. G.M.S. RIS
- 19-89 1200x2000mm THK. G.M.S. RIS
- 19-90 1200x2000mm THK. G.M.S. RIS
- 19-91 1200x2000mm THK. G.M.S. RIS
- 19-92 1200x2000mm THK. G.M.S. RIS
- 19-93 1200x2000mm THK. G.M.S. RIS
- 19-94 1200x2000mm THK. G.M.S. RIS
- 19-95 1200x2000mm THK. G.M.S. RIS
- 19-96 1200x2000mm THK. G.M.S. RIS
- 19-97 1200x2000mm THK. G.M.S. RIS
- 19-98 1200x2000mm THK. G.M.S. RIS
- 19-99 1200x2000mm THK. G.M.S. RIS
- 19-100 1200x2000mm THK. G.M.S. RIS

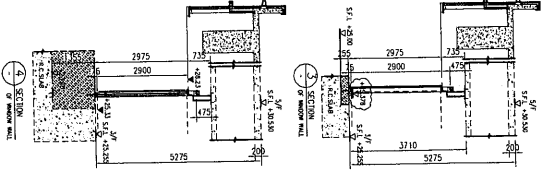
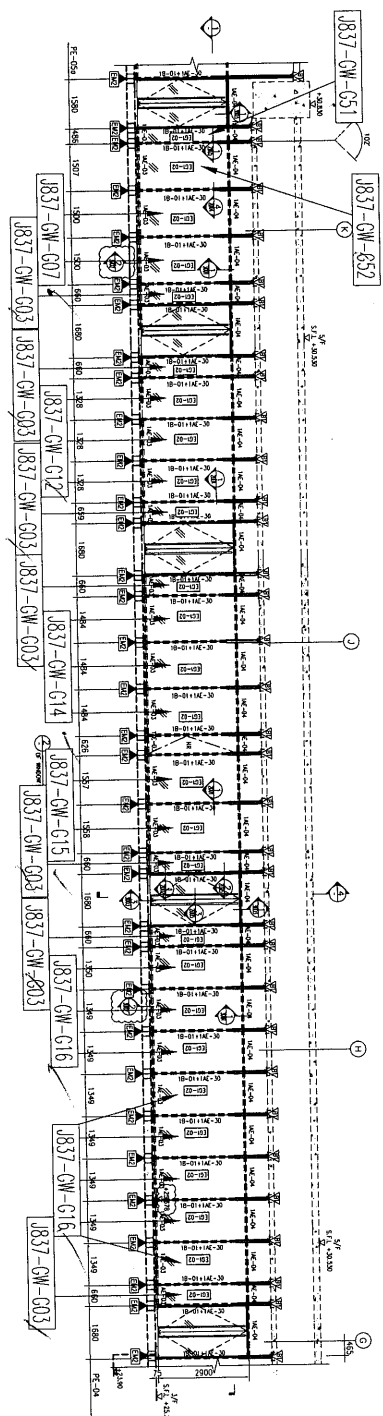
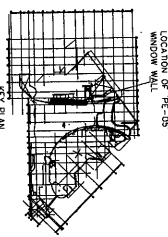

名稱	玻璃位置圖	制圖	曾建平	2019-03-05	修改		
材料		復核			日期		
顏色		批准			圖號	J837-GW-WZ42	

EG-DWG3



美特鋁質有限公司
MIDI Aluminium Fabricator Ltd.

工程號 J837 地盤 觀塘

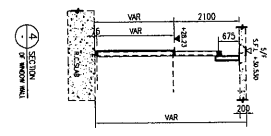
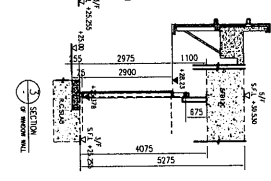
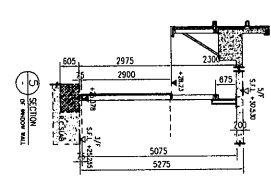
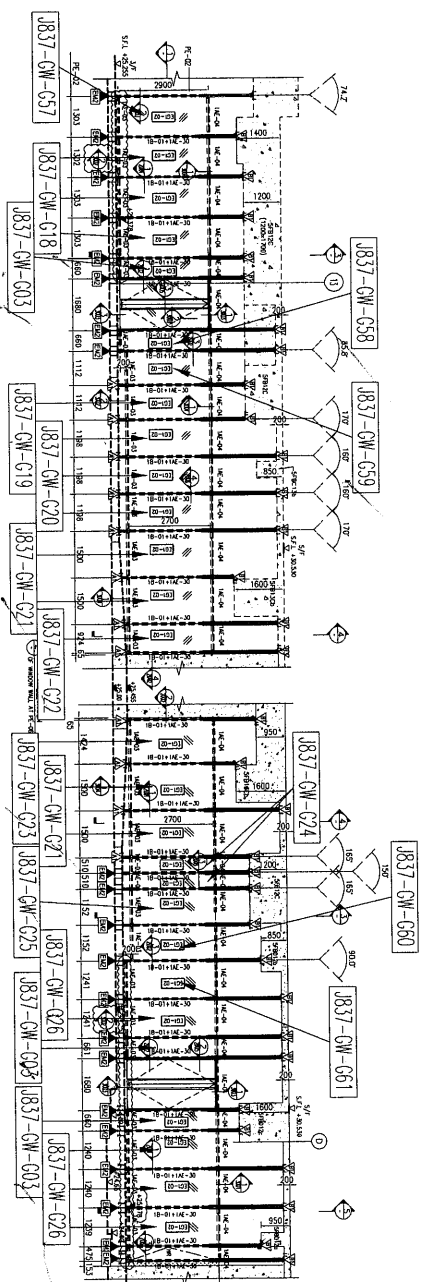
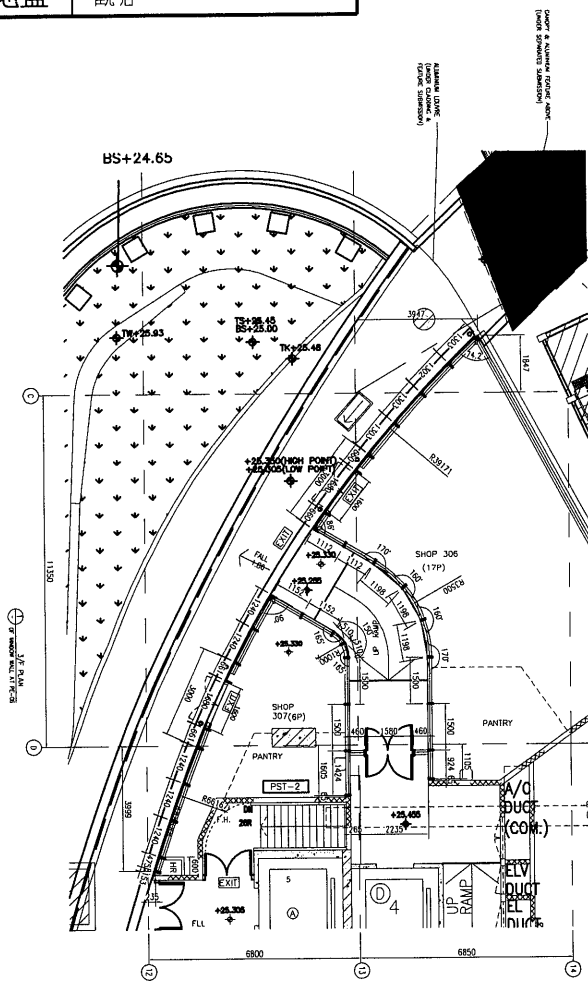

LEGEND:

- 12mm THK MONOLITHIC LOW RISE TEMPERED GLASS
- ALUMINIUM MULLION
- ALUMINIUM TRANSOM
- ALUMINIUM TRANSOM
- 120x60x6mm THK GLASS RISER
- 3mm THK ALUM CLADDING

SUPPORT LEGEND:

- 1/2" SH DIBED WITH 1 NO. GAS INJECTION 1 NO.
- 1/2" SH DIBED WITH 1 NO. GAS INJECTION 1 NO.
- 1/2" SH DIBED WITH 1 NO. GAS INJECTION 1 NO.
- 1/2" SH DIBED WITH 1 NO. GAS INJECTION 2 NO.
- 1/2" SH DIBED WITH 1 NO. GAS INJECTION 2 NO.

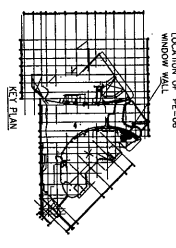

名稱	玻璃位置圖	制圖	曾建平	2019-03-05	修改	
材料		復核			日期	
顏色		批准			圖號	J837-GW-WZ44

EG-DWG3



美特鋁質 有限公司
MIDI Aluminium Fabricator Ltd.

工程號	J837	地盤	觀塘
-----	------	----	----

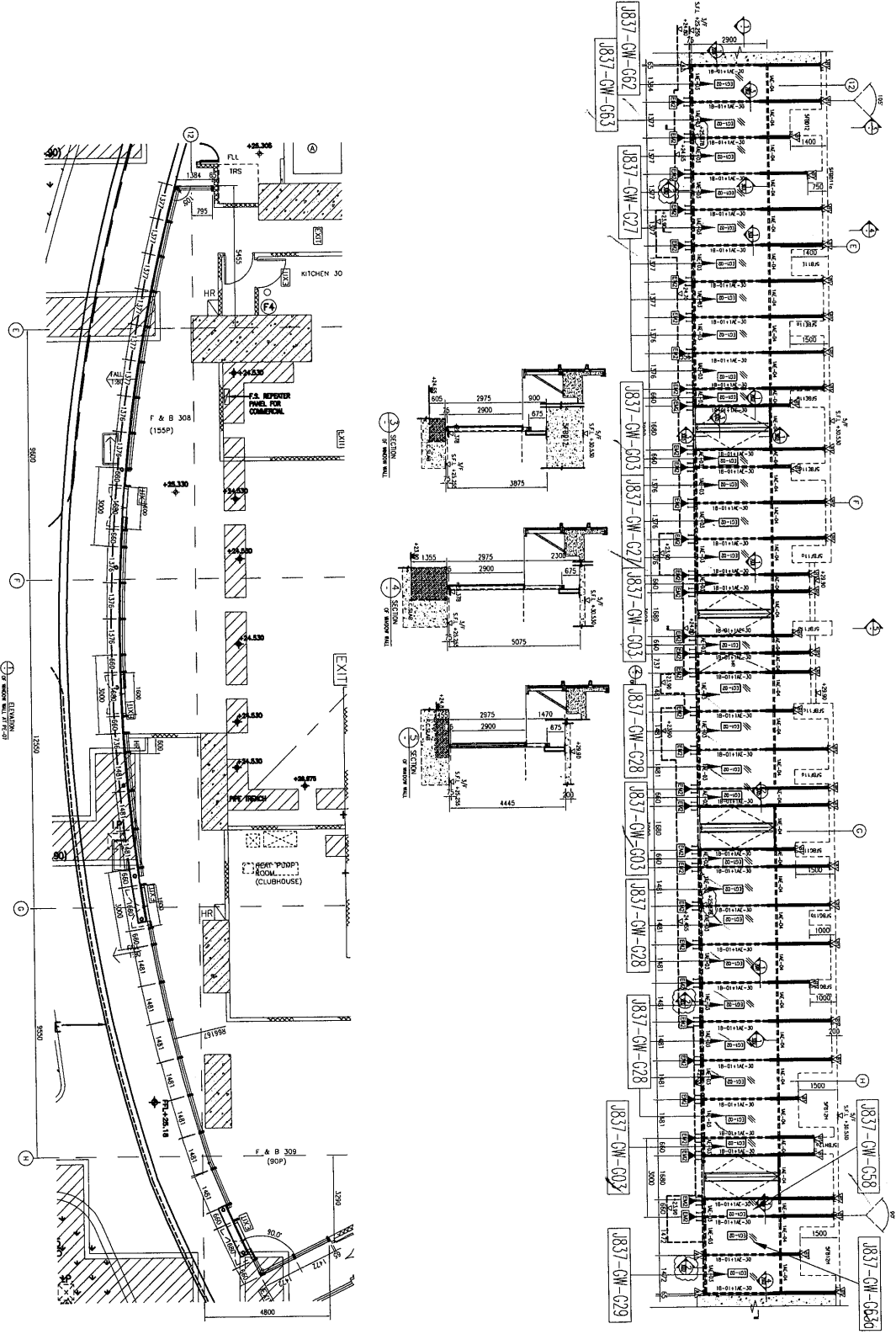

LEGEND:

	12mm THK WINDOWING LOW IRON TEMPERED GLASS
	ALUMINUM MILLWORK
	ALUMINUM TRANSOM
	12060x2400 THK GLASS PANE
	30mm THK ALUM CLADDING

SUPPORT LEGEND:

	17-A1 FIXED WITH 1 NO. GAS HOLDER 1 NO.
	17-B1 FIXED WITH 1 NO. GAS HOLDER 1 NO.
	17-C1 FIXED WITH 1 NO. GAS HOLDER 1 NO.
	17-D1 FIXED WITH 1 NO. GAS HOLDER 1 NO.
	17-E1 FIXED WITH 1 NO. GAS HOLDER 1 NO.
	17-F1 FIXED WITH 1 NO. GAS HOLDER 1 NO.
	17-G1 FIXED WITH 1 NO. GAS HOLDER 1 NO.
	17-H1 FIXED WITH 1 NO. GAS HOLDER 1 NO.
	17-I1 FIXED WITH 1 NO. GAS HOLDER 1 NO.
	17-J1 FIXED WITH 1 NO. GAS HOLDER 1 NO.
	17-K1 FIXED WITH 1 NO. GAS HOLDER 1 NO.
	17-L1 FIXED WITH 1 NO. GAS HOLDER 1 NO.
	17-M1 FIXED WITH 1 NO. GAS HOLDER 1 NO.
	17-N1 FIXED WITH 1 NO. GAS HOLDER 1 NO.
	17-O1 FIXED WITH 1 NO. GAS HOLDER 1 NO.
	17-P1 FIXED WITH 1 NO. GAS HOLDER 1 NO.
	17-Q1 FIXED WITH 1 NO. GAS HOLDER 1 NO.
	17-R1 FIXED WITH 1 NO. GAS HOLDER 1 NO.
	17-S1 FIXED WITH 1 NO. GAS HOLDER 1 NO.
	17-T1 FIXED WITH 1 NO. GAS HOLDER 1 NO.
	17-U1 FIXED WITH 1 NO. GAS HOLDER 1 NO.
	17-V1 FIXED WITH 1 NO. GAS HOLDER 1 NO.
	17-W1 FIXED WITH 1 NO. GAS HOLDER 1 NO.
	17-X1 FIXED WITH 1 NO. GAS HOLDER 1 NO.
	17-Y1 FIXED WITH 1 NO. GAS HOLDER 1 NO.
	17-Z1 FIXED WITH 1 NO. GAS HOLDER 1 NO.

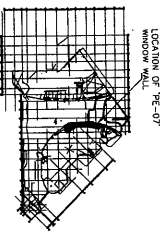

名稱	玻璃位置圖	制圖	曾建平	2019-03-05	修改	
材料		復核			日期	
顏色		批准			圖號	J837-GW-WZ45

EG-DWG3



美特鋁質 有限公司
MIDI Aluminium Fabricator Ltd.

工程號	J837	地盤	觀塘
-----	------	----	----

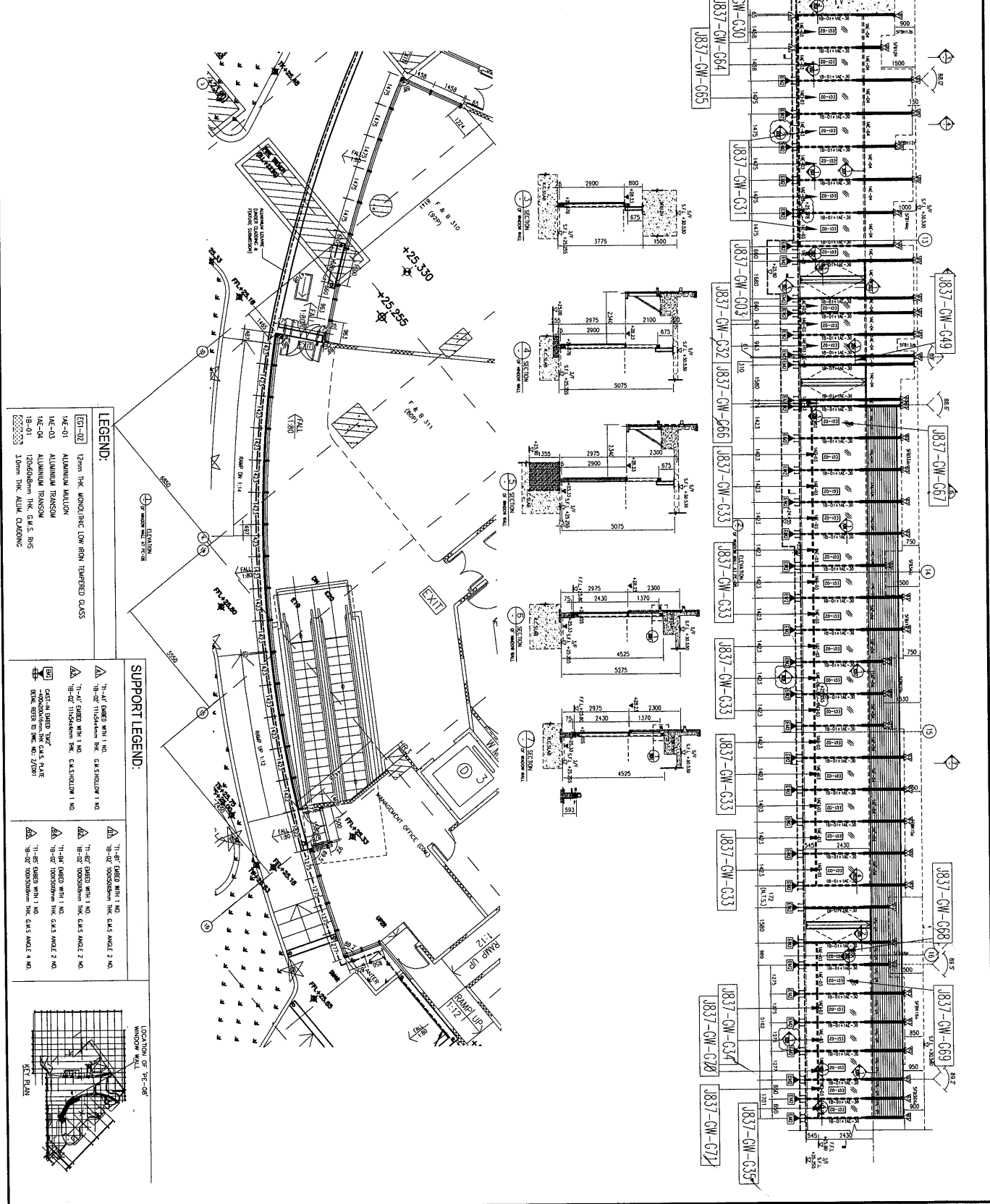

名稱	玻璃位置圖	制圖	曾建平	2019-03-05	修改
材料		復核			日期
顏色		批准			圖號
					J837-GW-WZ46