

ET0098

16/4/2019

特權訂出機以下之零件

Johnny

ST-52 x 2nos	ST-59 x 1	ST-55 x 2nos
ST-53a x 5nos	ST-60 x 1	ST-58 x 12nos
ST-53b x 1nos	ST-61 x 1	ST-69 x 3nos
ST-73 x 7nos	ST-80 x 1	ST-71 x 2nos
ST-74 x 15nos	ST-81 x 1	ST-66 x 2nos
ST-75 x 4nos	ST-82 x 1	ST-72 x 3nos
ST-77 x 2nos	ST-83 x 1	ST-92 x 1nos
ST-77 x 2nos	ST-84 x 1	ST-93 x 1nos

38

+

8

+

26

72 nos

ST-52 x 5nos
ST-54 x 1nos
ST-56 x 1nos
ST-58 x 5nos
ST-60a x 2nos

- 14nos

+

totals = 86nos

美特鋁質 有限公司
MIDI Aluminium Fabricator Ltd.

工程號 J837 地盤 觀塘

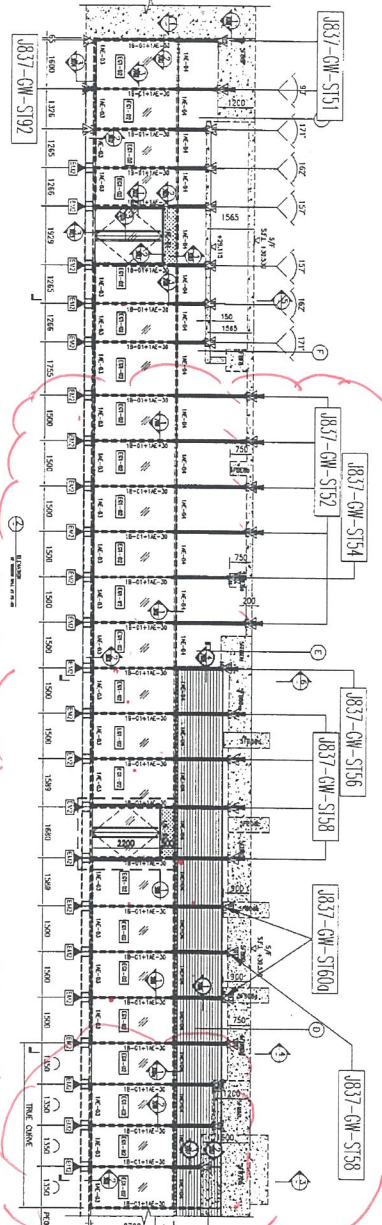
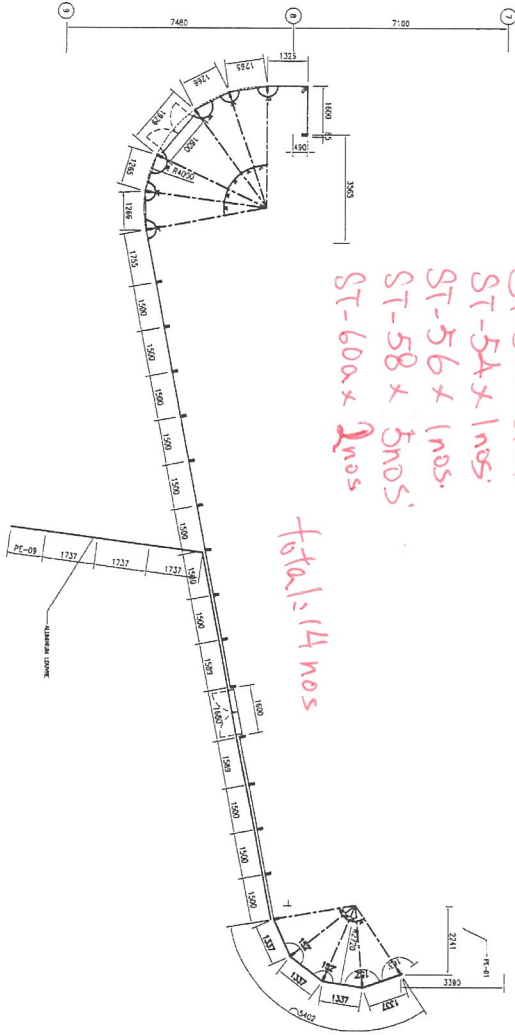

LEGEND:

EC1-02	2mm THK ANTIROLLING LOW IRON TINTED GLASS
1A-E-01	ALUMINIUM MULLION
1A-C-03	ALUMINIUM TRANSOM
1A-E-04	ALUMINIUM TRANSOM
1B-01	200G/GDOWN THK. CALS. BRG.
EC3-03	30mm THK. ALUM. CLADDING

SUPPORT LEGEND:

△	TH-01 TYPED WITH 1 NO. CASTIRON 1 NO.
△	TH-02 TYPED WITH 1 NO. CASTIRON 1 NO.
△	TH-03 TYPED WITH 1 NO. CASTIRON 1 NO.
△	TH-04 TYPED WITH 1 NO. CASTIRON 1 NO.
△	TH-05 TYPED WITH 1 NO. CASTIRON 1 NO.
△	TH-06 TYPED WITH 1 NO. CASTIRON 1 NO.
△	TH-07 TYPED WITH 1 NO. CASTIRON 1 NO.
△	TH-08 TYPED WITH 1 NO. CASTIRON 1 NO.
△	TH-09 TYPED WITH 1 NO. CASTIRON 1 NO.
△	TH-10 TYPED WITH 1 NO. CASTIRON 1 NO.
△	TH-11 TYPED WITH 1 NO. CASTIRON 1 NO.
△	TH-12 TYPED WITH 1 NO. CASTIRON 1 NO.
△	TH-13 TYPED WITH 1 NO. CASTIRON 1 NO.
△	TH-14 TYPED WITH 1 NO. CASTIRON 1 NO.
△	TH-15 TYPED WITH 1 NO. CASTIRON 1 NO.
△	TH-16 TYPED WITH 1 NO. CASTIRON 1 NO.
△	TH-17 TYPED WITH 1 NO. CASTIRON 1 NO.
△	TH-18 TYPED WITH 1 NO. CASTIRON 1 NO.
△	TH-19 TYPED WITH 1 NO. CASTIRON 1 NO.
△	TH-20 TYPED WITH 1 NO. CASTIRON 1 NO.

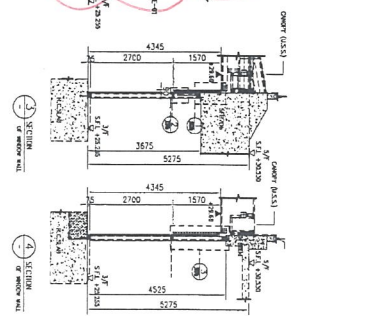
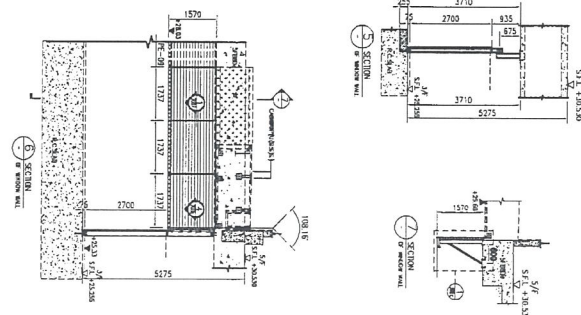
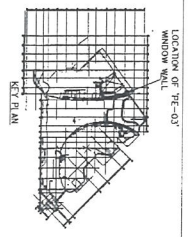

名稱	鐵件位置圖	制圖	曾建平	2018-12-24	修改	
材料		復核			日期	
顏色		批准			圖號	J837-GW-WZ11

45
69

E10098

EG-DWG3

美特鋁質 有限公司
MIDI Aluminium Fabricator Ltd.

工程號	J837	地盤	觀塘
-----	------	----	----

ST-55x2 nos
ST-58x12 nos
ST-69x3 nos
ST-71x2 nos
ST-66x2 nos
ST-72x3 nos
ST-93x1 nos
ST-92x1

H₁₀₀₁=2600

LEGEND:

	7mm T&M GLAZING
	ALUMINIUM MULLION
	ALUMINIUM TRANSOM
	2000mm T&M GLAZING
	3mm T&M CLADDING

SUPPORT LEGEND:

	100x100x1000mm STEEL ANGLE 1 NO.
	100x100x1000mm STEEL ANGLE 2 NO.
	100x100x1000mm STEEL ANGLE 3 NO.
	100x100x1000mm STEEL ANGLE 4 NO.

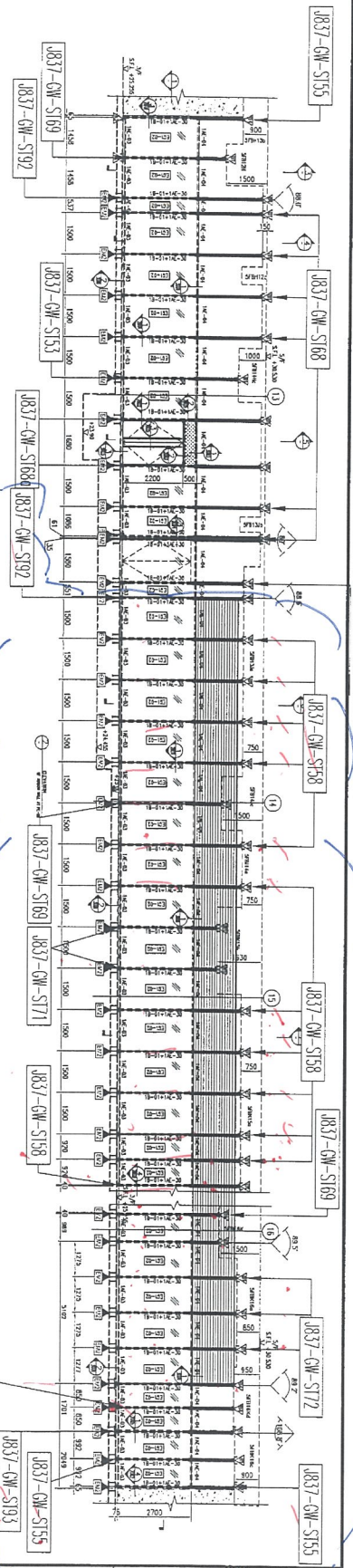
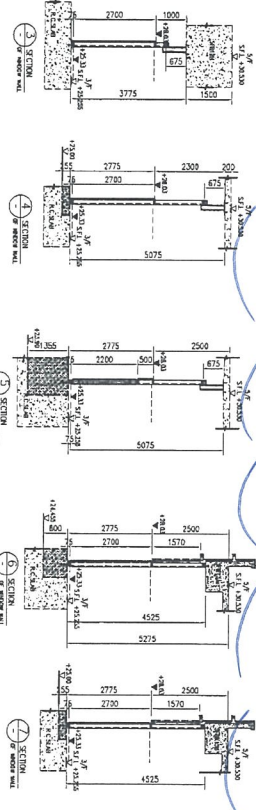
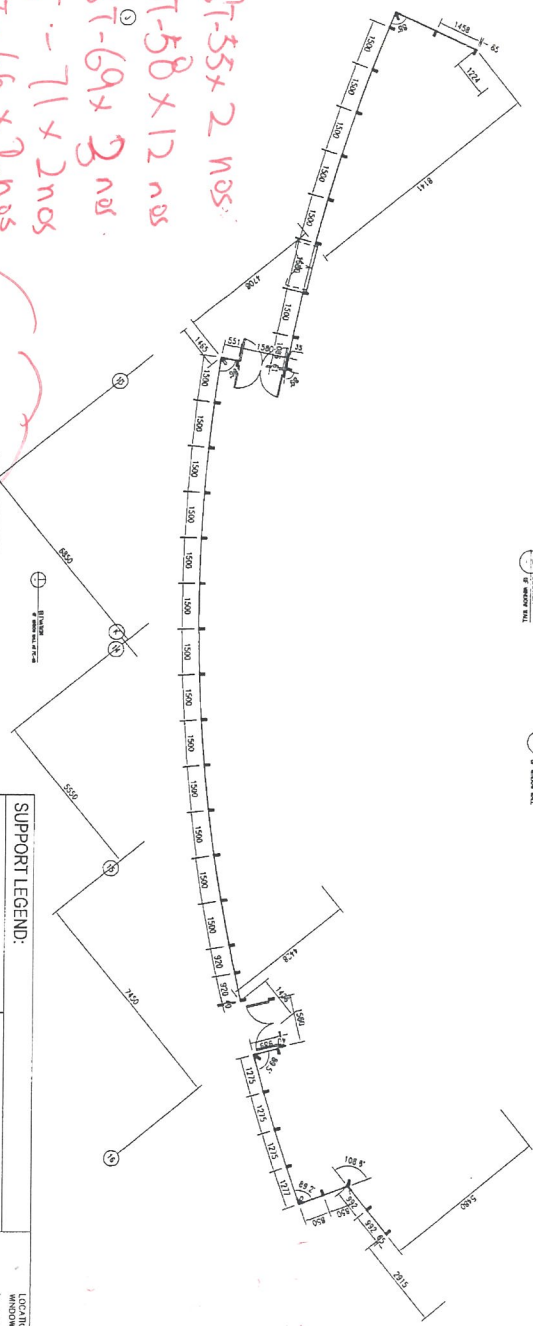

名稱	鐵件位置圖	制圖	曾建平	2018-12-24	修改	
材料		復核			日期	
顏色		批准			圖號	J837-GW-WZ'7



美特鋁質 有限公司
MIDI Aluminium Fabricator Ltd.

工程號 J837 地盤 觀塘

ES0098

