



工程指示 / 要求簡箋(E.I.)

工程指示編號：EI / 0101 / 19

修改版次：-

工程編號：J - 837

工程名稱：觀塘裕民坊

工程項目：幕牆 室外企身防水角(樣板層用,T1-T5)

收件人：生統/永林

發件人：Eric Liu

日期：17/01/2019

要求提供 / 確認 事項：

- | | | |
|------------------------------------|-------------------------------------|-------------------------------|
| <input type="checkbox"/> 初步鋁料 B.M. | <input type="checkbox"/> 加工拆圖，然後生產 | <input type="checkbox"/> 尺寸表 |
| <input type="checkbox"/> 正式鋁料 B.M. | <input type="checkbox"/> 技術上資料 / 指示 | <input type="checkbox"/> 報價 |
| <input type="checkbox"/> 配件 B.M. | <input type="checkbox"/> 樣辦或貨品說明書 | <input type="checkbox"/> 分判合約 |
| <input type="checkbox"/> 其他：_____ | | |

內容：

請按加工圖生產室外企身防水角，送地盤安裝用 (樣板層,7-9/F 用)(大圖:1/5010)

謝謝！

大圖 3/3905, 2號圖

謝謝！

請在 2019/01/19 前完成上列要求。

附：1 頁 B.M.，1 頁圖登，2 頁加工圖，19 頁位置圖

以上項目為：

- 原合約工程包 原合約工程加 / 減賬 新工程報價

原因：-

分發東莞各部門：

- () 生產技術總監 連附件 () 技術部 連附件 () 生產部 連附件 () 機械設計部 連附件
 () 採購部 連附件 () 生產統籌部 連附件
 () 質檢部 連附件 () 會計部 連附件 () 報關組 連附件 () 其他 楊榮輝 連附件

分發其他分判：

- () 王禮秋 連附件

分發香港各部門：

- () 行政部 連附件 () 會計部 連附件 () 統籌部 連附件 () 工程部地盤科文 連附件
 () 採購部 連附件 () QS 部 連附件 () 維修部 連附件 () 其他 _____ 連附件

傳遞編號：

HK 0162 / 19

發件人簽署：

項目經理簽署：

		工程號: J-837	計算: 鞠章芳	日期:	2019.1.14		送呈: 胡哥								
		地盤名稱: 觀塘裕民坊	核對: 謝永林	日期:			副本:								
地盤用鋁板B.M.表		項目類別: 幕牆	批准:	日期:											
BM編號: 837-CW-M01-S-BP02		修改版次:	A/C Code :	總V.F.:	0.000		總重量:	41.66	此BM依據EI/9536/18 資料計算						
序號	修改內容	鋁板圖號	鋁板名稱	顏色	實用	後備	總數	總重量	單件展開面積	總展開面積	單件V.F.		總V.F.	使用位置	樓層
											平方米				
1		FS-H30	1.5mm厚鋁板	Mill絡化	105	0	105	41.66	0.098	10.25	0.000	0.000	見位置圖	7F-9F	
2		FS-5005-3-2	1.5mm	Mill	99	0	99								
3															
4															
5															
6															
7															
8															
9															
10															
11															
12															
13															
14															
15															
16															

圖則登記表 DRAWING REGISTER									
工程名稱 Project Title		觀塘裕民坊 幕牆7F-9F室外企向防水片拆圖		接收日期 Receiving Date (適用於客戶圖則)					
工程編號 Project No		J-837		年					
分發予 Distributed To				月					
				日					
				年		19			
				月		1			
				日		14			
圖則編號 Drg. No.		圖則名稱 Drawing Title		修訂編號 Revision No.					
FS-H30		防水片-拆圖		1	-				
J837-CW-2102		位置圖		2	-				
J837-CW-2103		位置圖		3	-				
J837-CW-2105		位置圖		4	-				
J837-CW-2107		位置圖		5	-				
J837-CW-2109		位置圖		6	-				
J837-CW-2113		位置圖		7	-				
J837-CW-2205		位置圖		8	-				
J837-CW-2206		位置圖		9	-				
J837-CW-2208		位置圖		10	-				
J837-CW-2209		位置圖		11	-				
J837-CW-2211		位置圖		12	-				
J837-CW-2302		位置圖		13	-				
J837-CW-2308		位置圖		14	-				
J837-CW-2310		位置圖		15	-				
J837-CW-2502		位置圖		16	-				
J837-CW-2503		位置圖		17	-				
J837-CW-2505		位置圖		18	-				
J837-CW-2508		位置圖		19	-				
J837-CW-2512		位置圖		20	-				



美特鋁質 有限公司
MIDI Aluminium Fabricator Ltd.

工程號 J-837 地盤 觀塘裕民坊

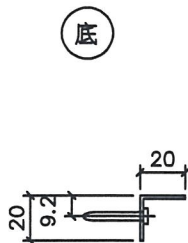
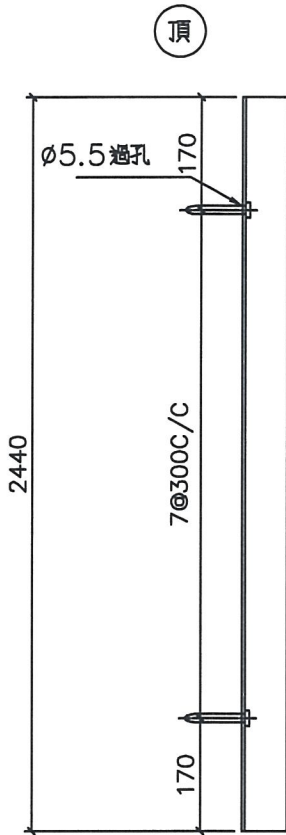

總層	總數量	使用位置	樓層
3	5	T1CW G-1	7F~9F
3	5	T1CW D-1	7F~9F
3	5	T1CW A-1	7F~9F
3	5	T1CW C-1	7F~9F
3	5	T1CW H-2	7F~9F
3	5	T1CW F-2	7F~9F
3	5	T2CW N-2	7F~9F
3	10	T2CW C-2	7F~9F
3	5	T2CW A-1	7F~9F
3	5	T2CW B-2	7F~9F
3	5	T2CW M-2	7F~9F
3	5	T3CW E-1	7F~9F
3	5	T3CW A-1	7F~9F
3	5	T3CW B-2	7F~9F
3	5	T5CW N-1	7F~9F
3	5	T5CW L-1	7F~9F
3	5	T5CW H-2	7F~9F
3	5	T5CW M-2	7F~9F
3	10	T5CW C-1	7F~9F
合計 :	105		

地盤安裝

5010

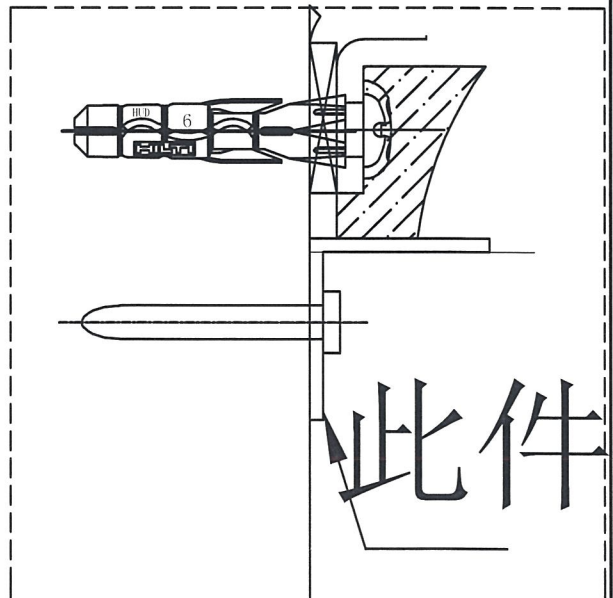

此件

名稱	防水片拆圖	制圖	韓芳	2019.1.9	修改			
材料	1.5mm鋁	復核			日期			
顏色	銀 M911	批准			圖號	FS-H30		



美特鋁質 有限公司
MIDI Aluminium Fabricator Ltd.

工程號 J-837 地盤 觀塘裕民坊

總層	總數量	使用位置	樓層
3	5	T1CW G-1	7F~9F
3	5	T1CW D-1	7F~9F
3	5	T1CW A-1	7F~9F
3	5	T1CW C-1	7F~9F
3	5	T1CW H-2	7F~9F
3	5	T1CW F-2	7F~9F
3	5	T2CW N-2	7F~9F
3	10	T2CW C-2	7F~9F
3	5	T2CW A-1	7F~9F
3	5	T2CW B-2	7F~9F
3	5	T2CW M-2	7F~9F
3	5	T3CW E-1	7F~9F
3	5	T3CW A-1	7F~9F
3	5	T3CW B-2	7F~9F
3	5	T5CW N-1	7F~9F
3	5	T5CW L-1	7F~9F
3	5	T5CW H-2	7F~9F
3	5	T5CW M-2	7F~9F
3	10	T5CW C-1	7F~9F
合計 :	105		

99件

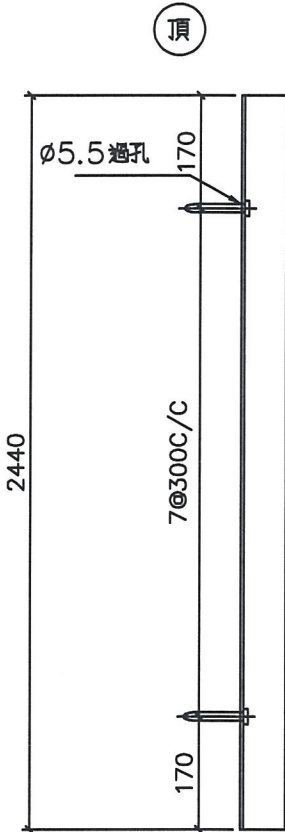

頂

底

9x3 T1 正正 (27)
 2号圖A 7x3 T2 正正 (21)
 7x3 T3 正正 (21)
 10x3 地盤安裝 T5 正正 (30)

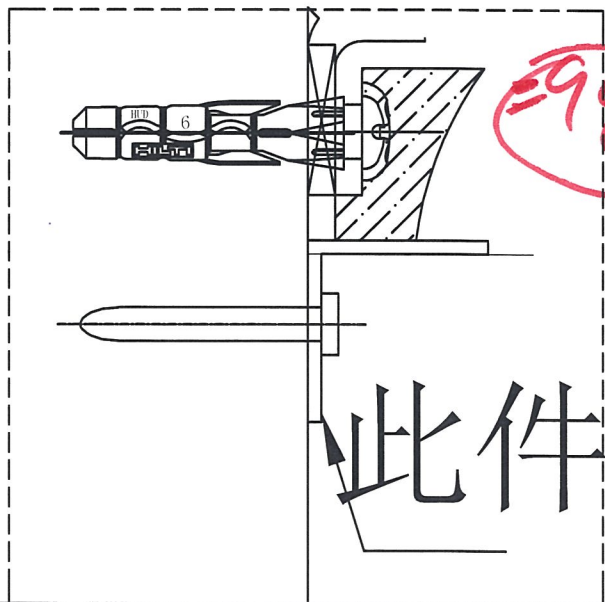
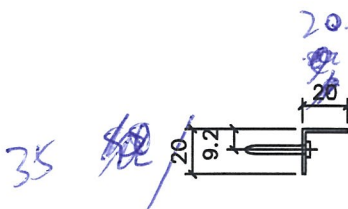

99件

3
5295

名稱	防水片	制圖	韓芳	2019.1.9	修改	FS-5005-3-2
材料	1.5mm鋁	復核			日期	
顏色	銀	批准			圖號	FS-H30

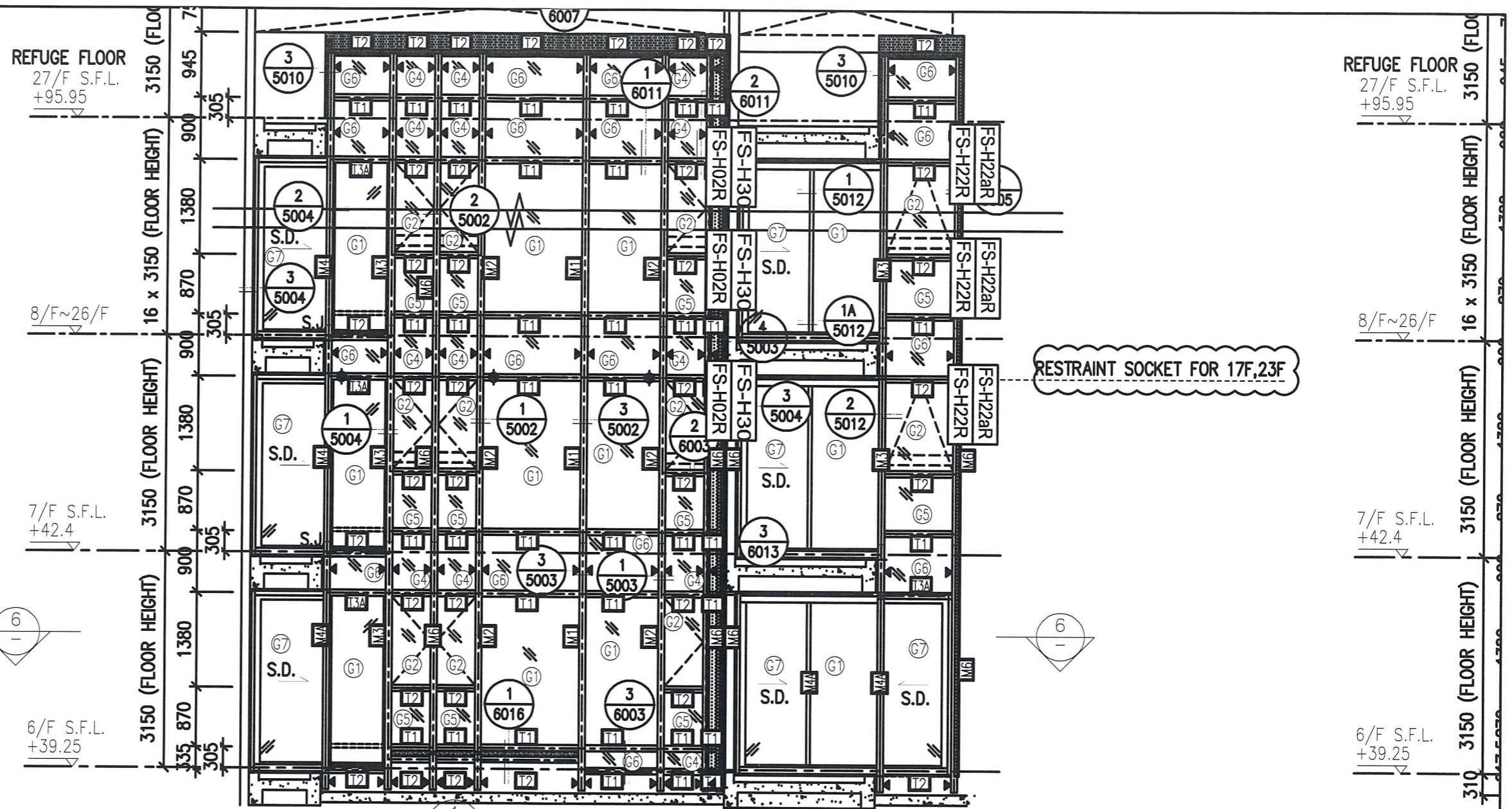

1 PART ELEVATION FOR CURTAIN WALL

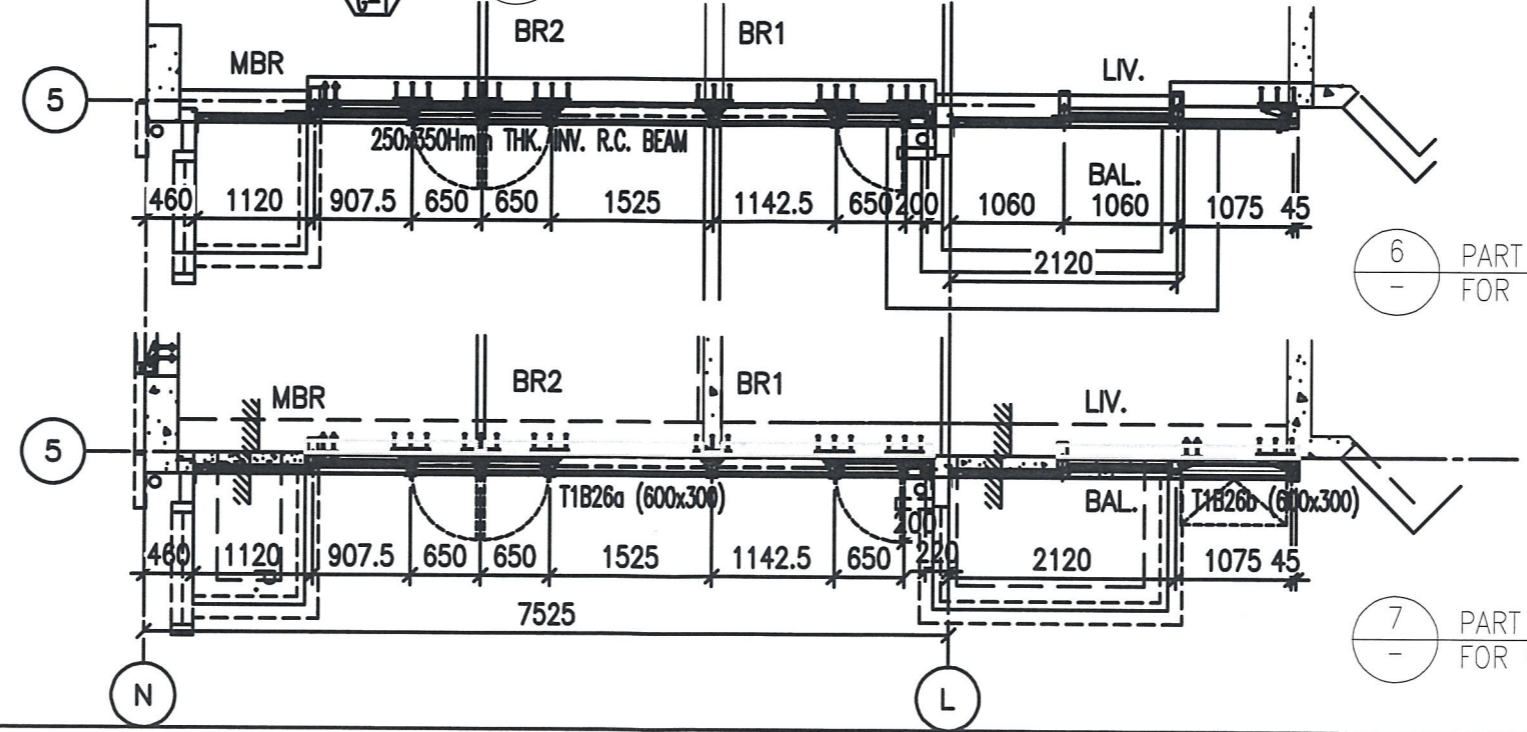

6 PART PLAN FOR CURTAIN WALL

7 PART PLAN FOR CURTAIN WALL

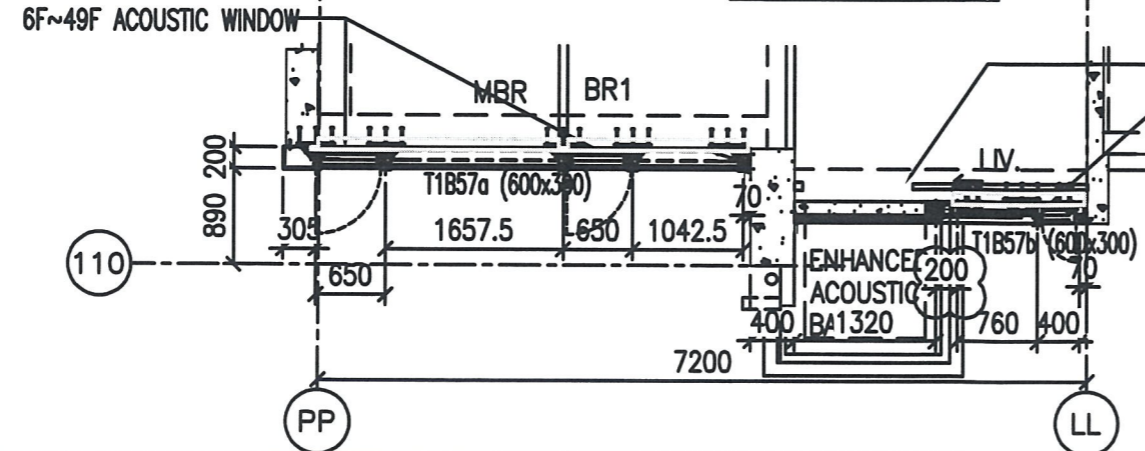
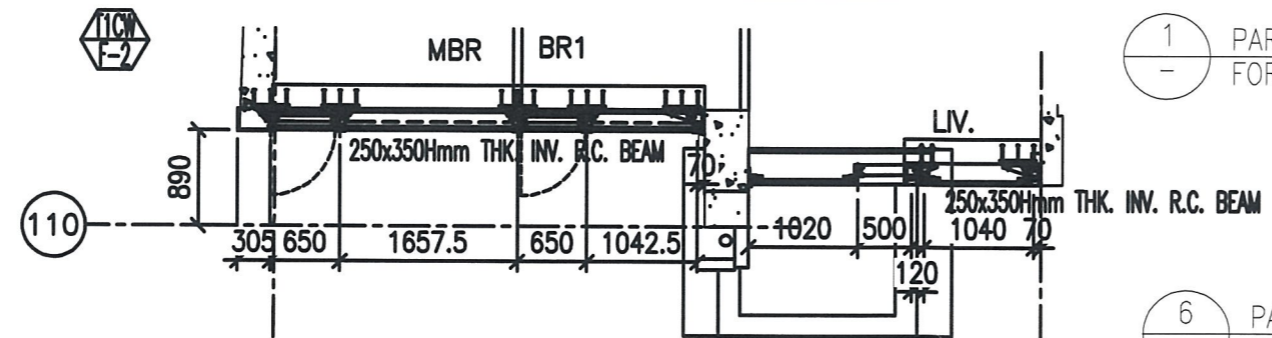
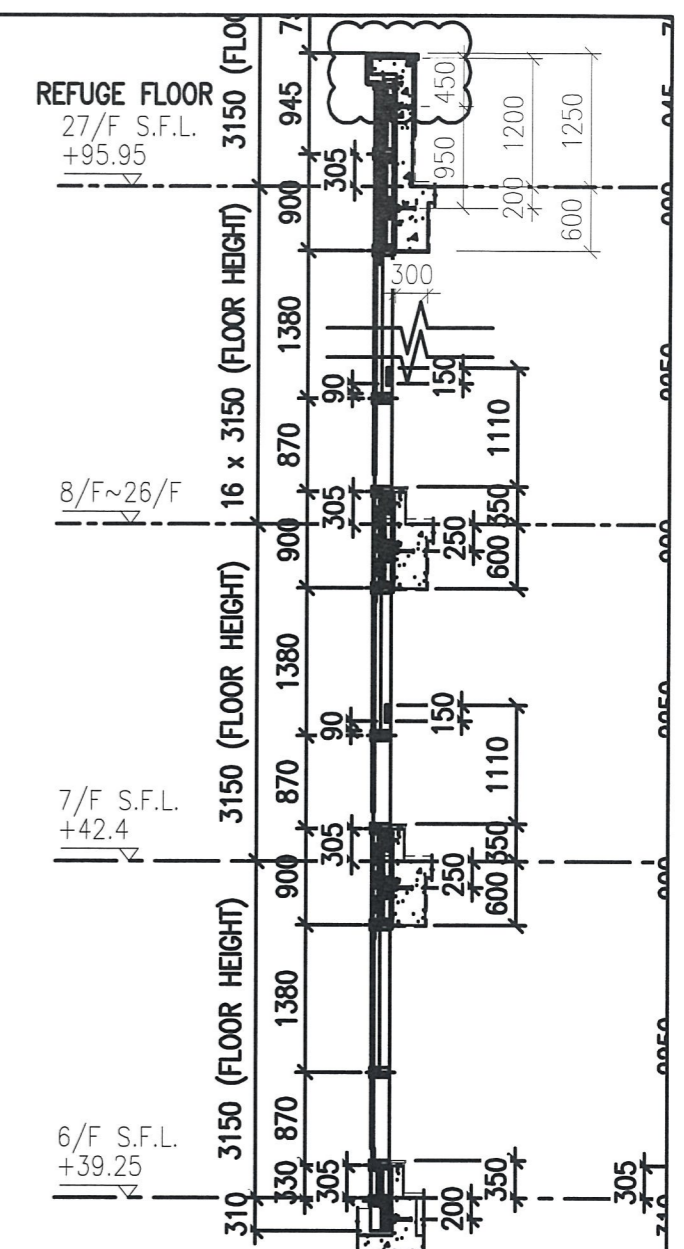
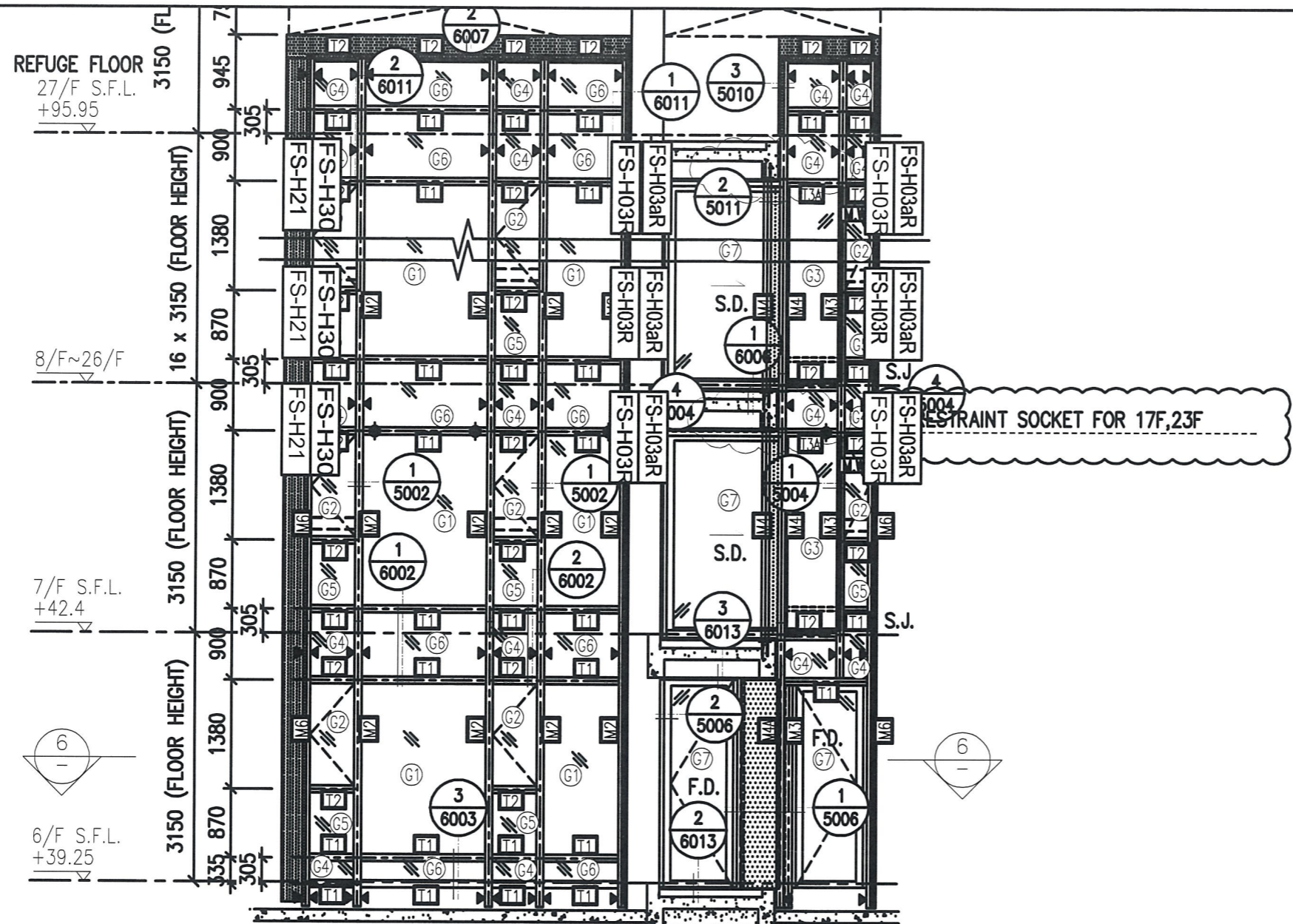

1 PART ELEVATION FOR CURTAIN WALL

2 TYPICAL SECTION FOR CURTAIN WALL

3 TYPICAL SECTION FOR CURTAIN WALL

6 PART PLAN FOR CURTAIN WALL

7 PART PLAN FOR CURTAIN WALL

圖號: 837-CW-2103

REFUGE FLOOR
27/F S.F.L.
+95.95

REFUGE FLOOR
27/F S.F.L.
+95.95

8/F~26/F

8/F~26/F

7/F S.F.L.
+42.4

7/F S.F.L.
+42.4

6/F S.F.L.
+39.25

6/F S.F.L.
+39.25

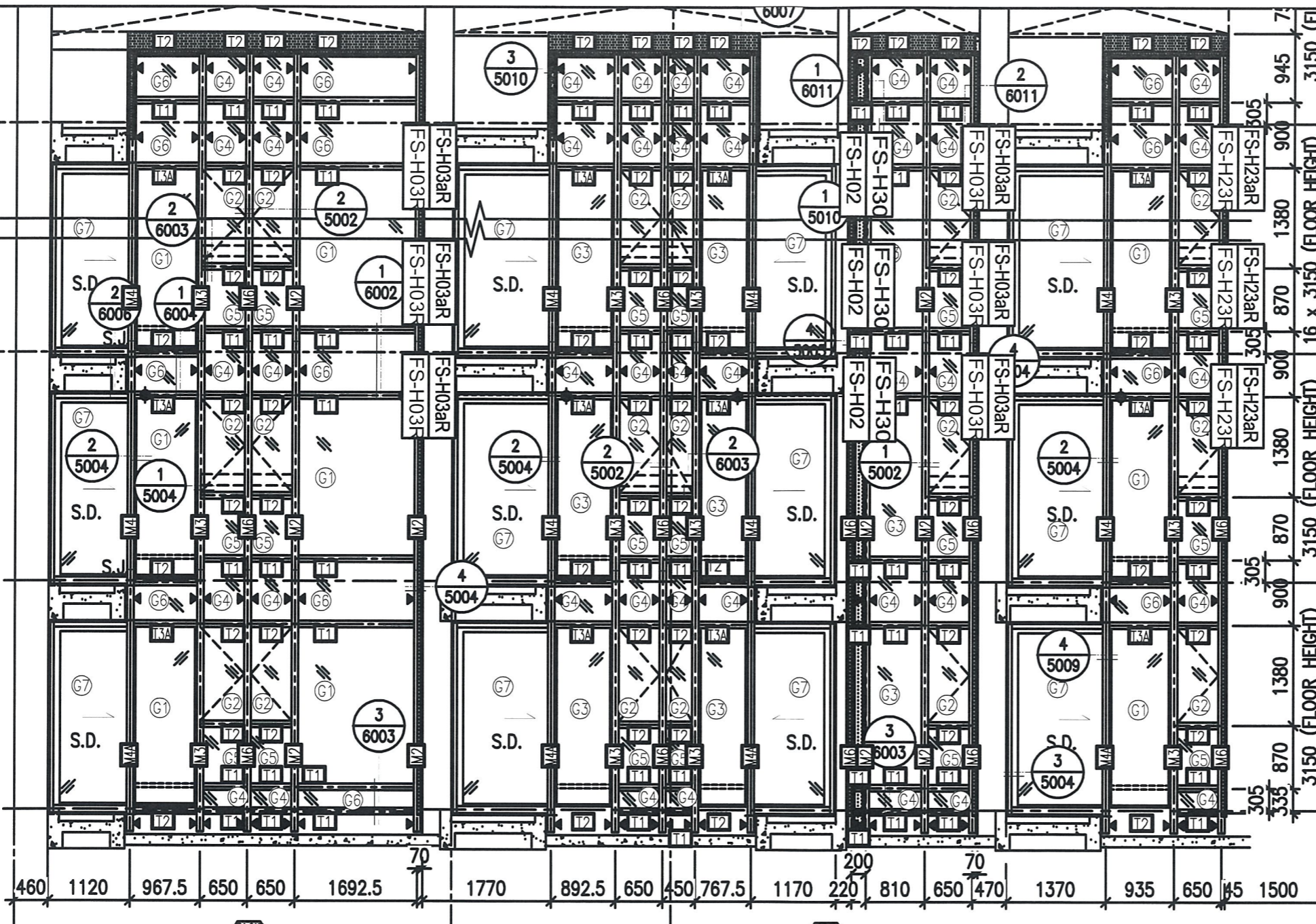

RESTRAINT SOCKET
FOR 17F,23F

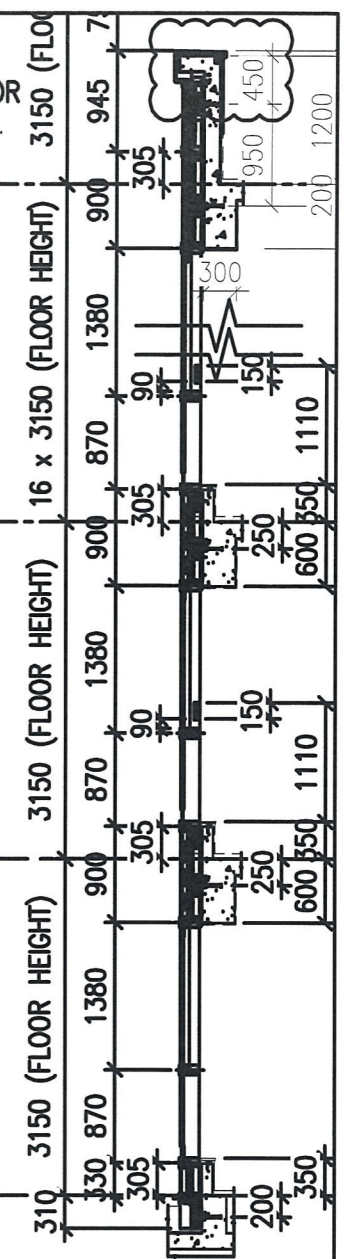

2 TYPICAL SECTION
FOR CURTAIN WALL

1 PART ELEVATION
FOR CURTAIN WALL

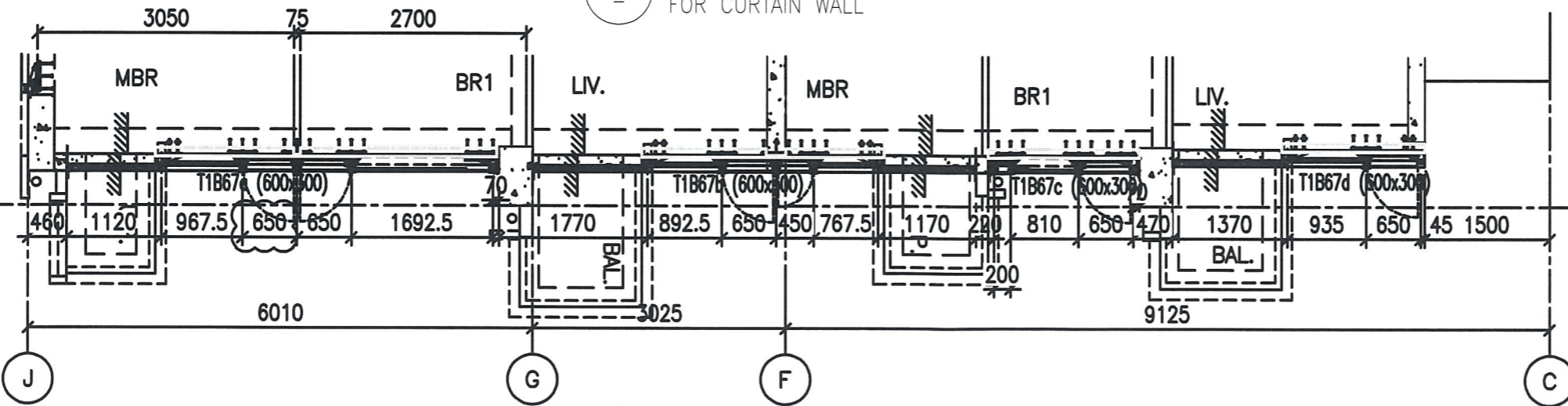

6 PART ELEVATION
FOR CURTAIN WALL

圖號: 837-CW-2105

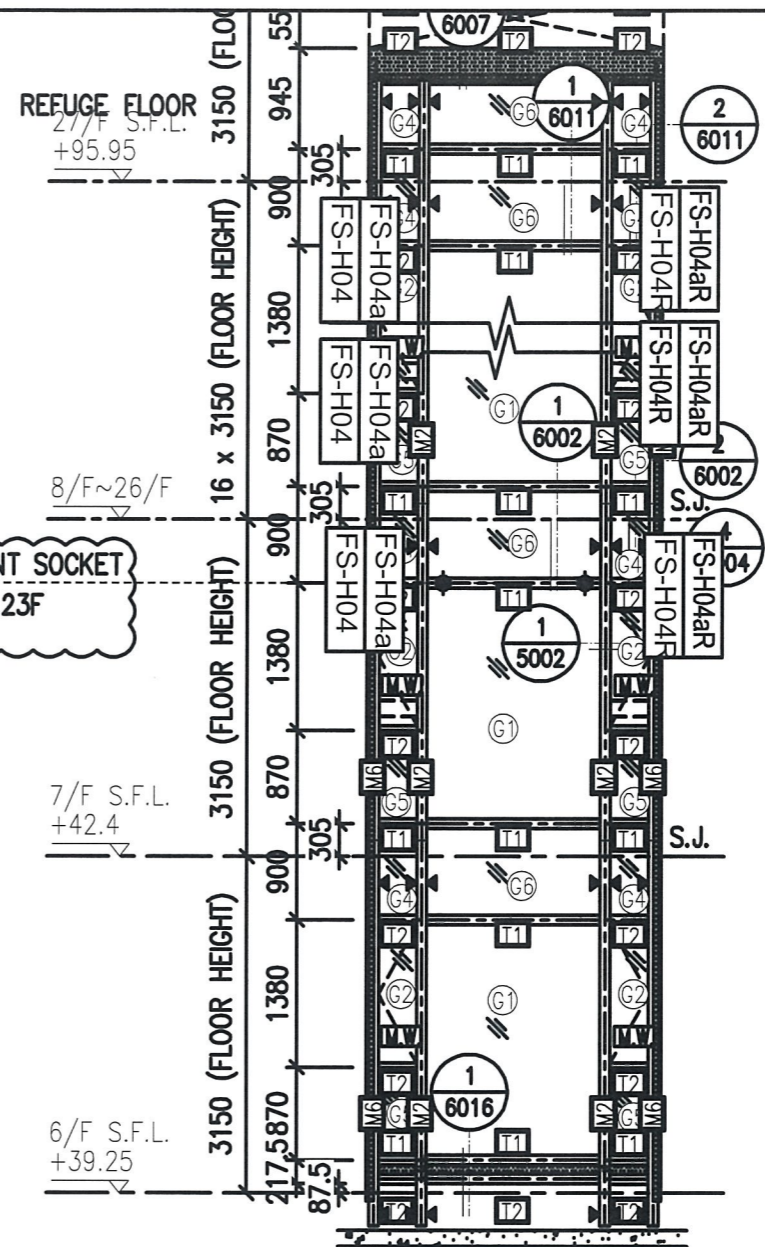
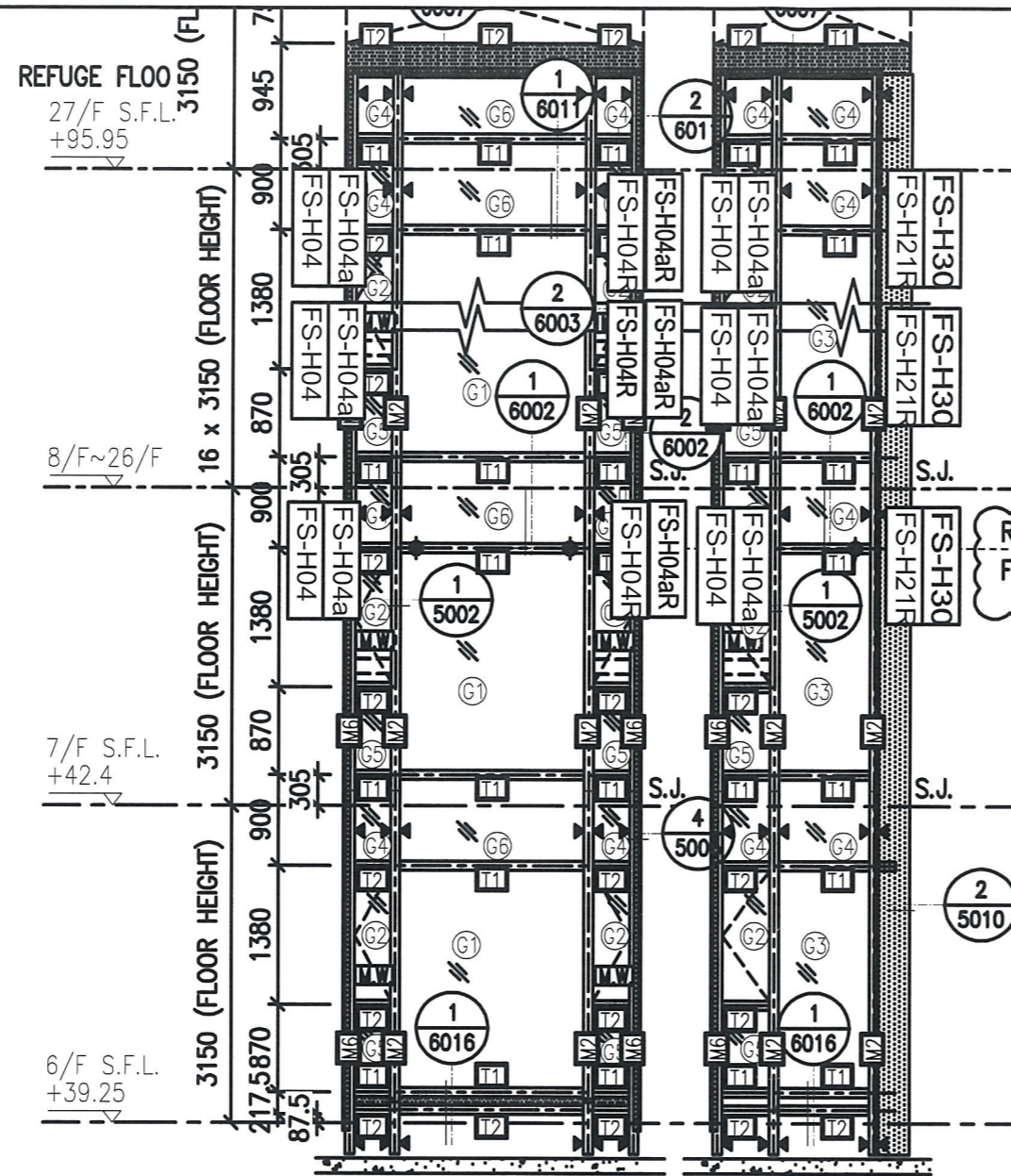

1 PART ELEVATION FOR CURTAIN WALL

2 PART ELEVATION FOR CURTAIN WALL

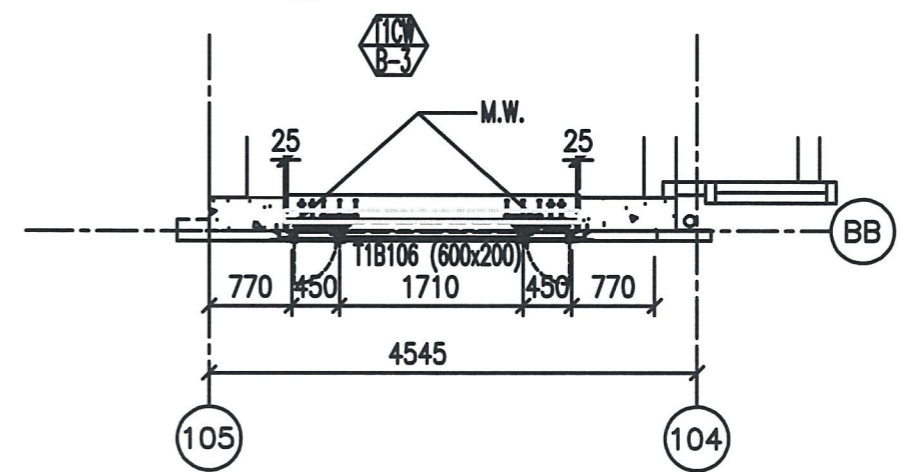
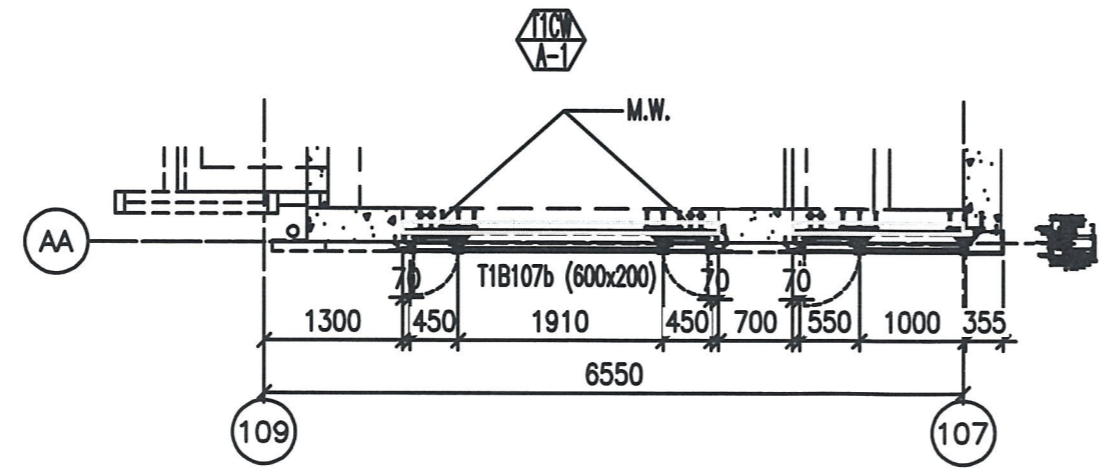

5 PART PLAN FOR CURTAIN WALL

6 PART PLAN FOR CURTAIN WALL

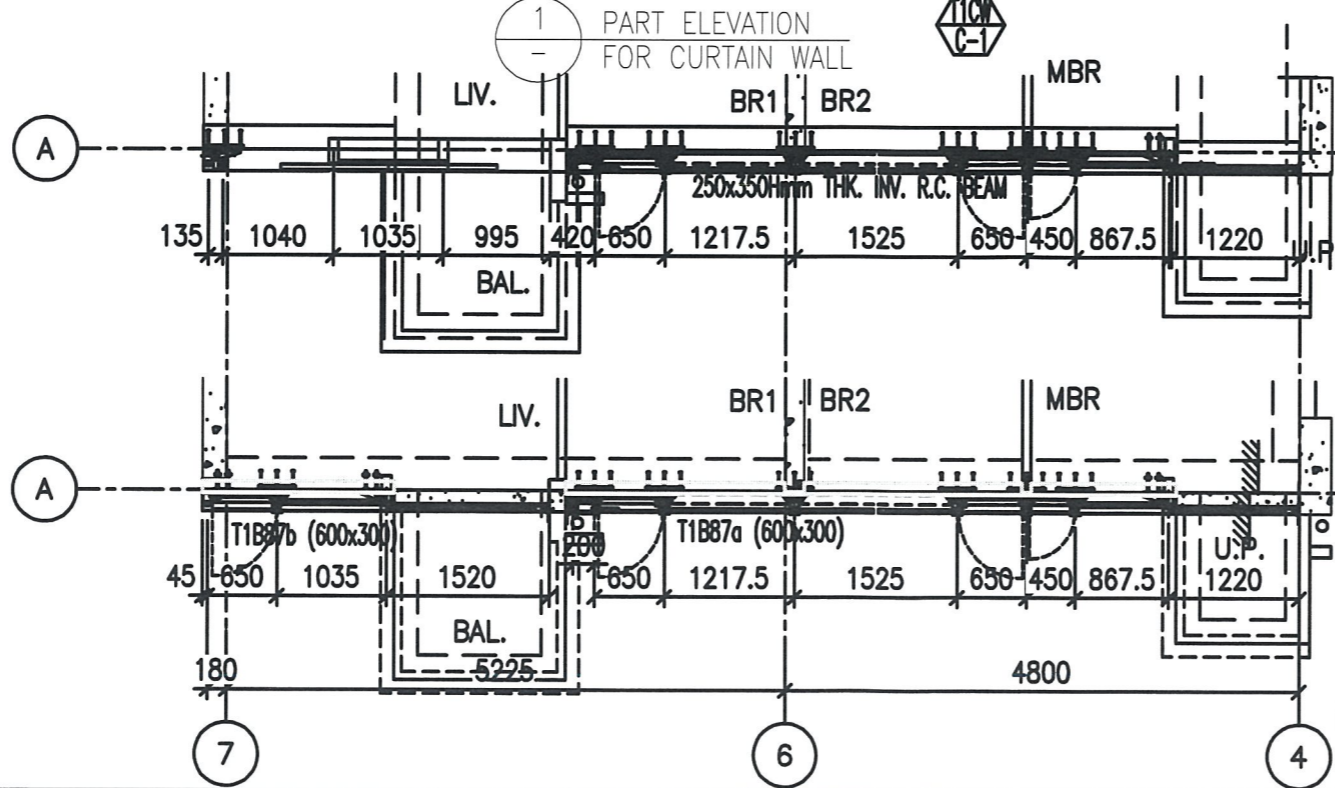
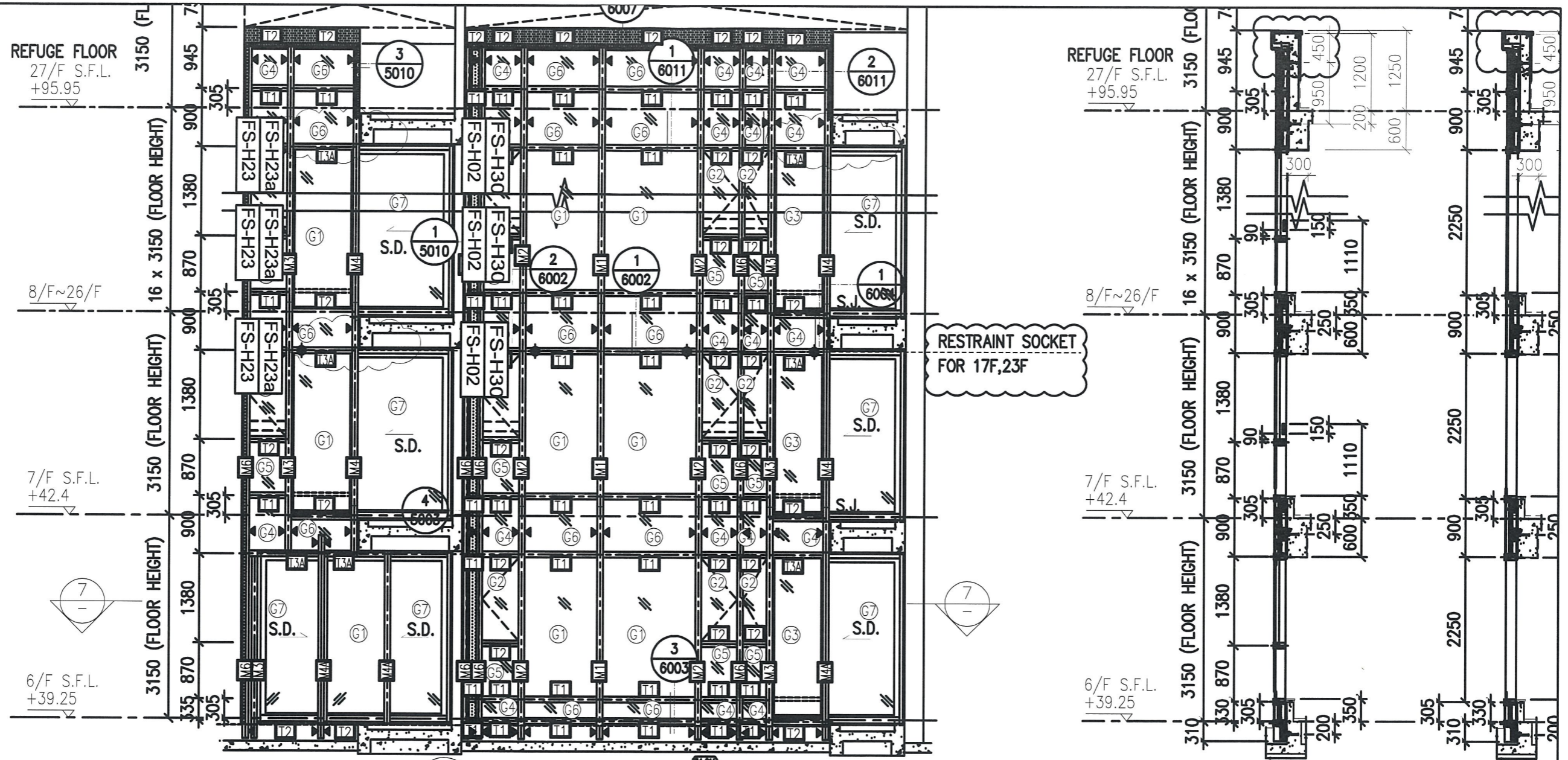

- 1 PART ELEVATION FOR CURTAIN WALL
- 2 TYPICAL SECTION FOR CURTAIN WALL
- 3 TYPICAL SECTION FOR CURTAIN WALL
- 7 PART PLAN FOR CURTAIN WALL
- 8 PART PLAN FOR CURTAIN WALL

圖號: 837-CW-2109

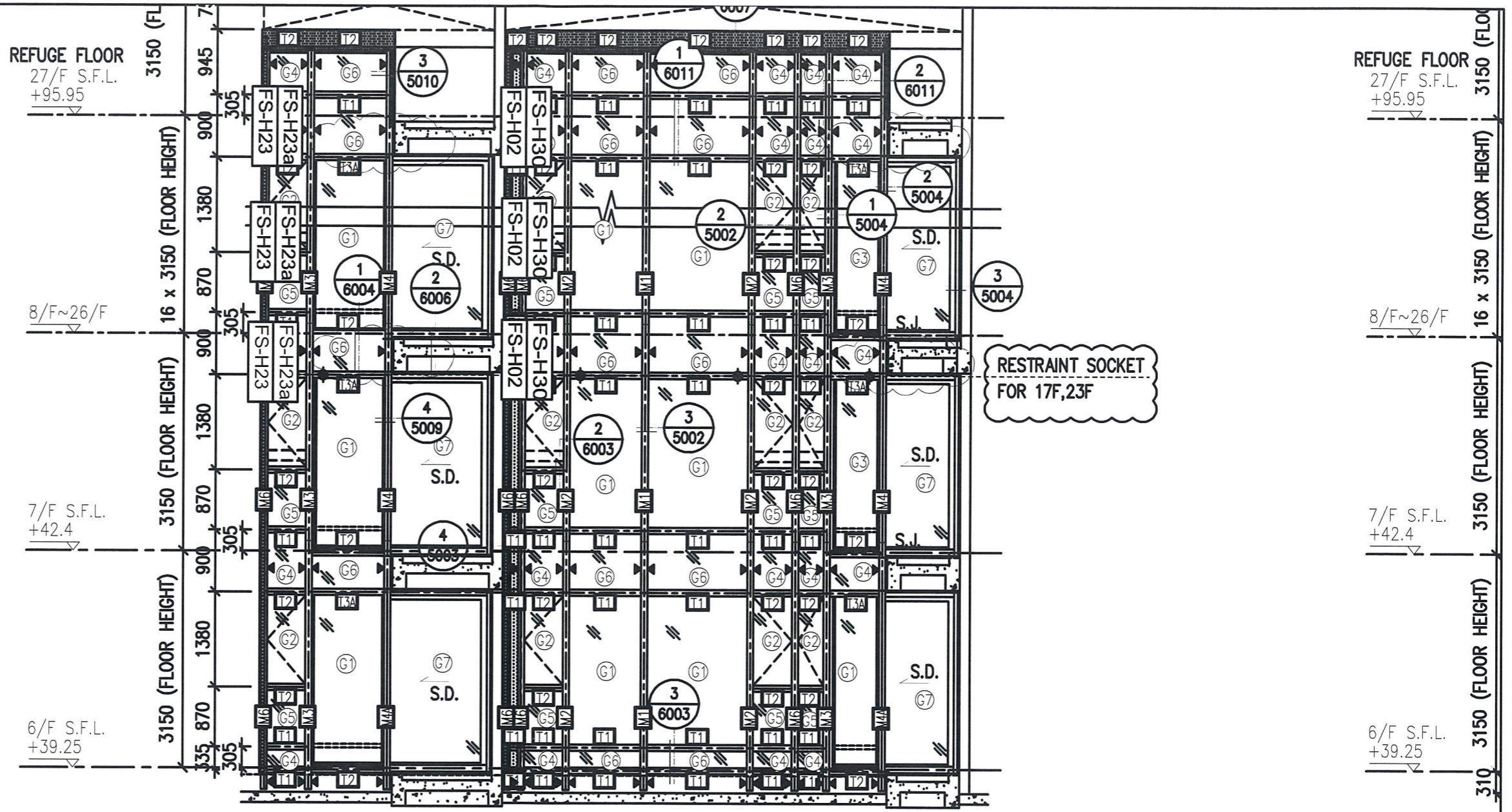

1 PART ELEVATION FOR CURTAIN WALL



2 TYPICAL FOR

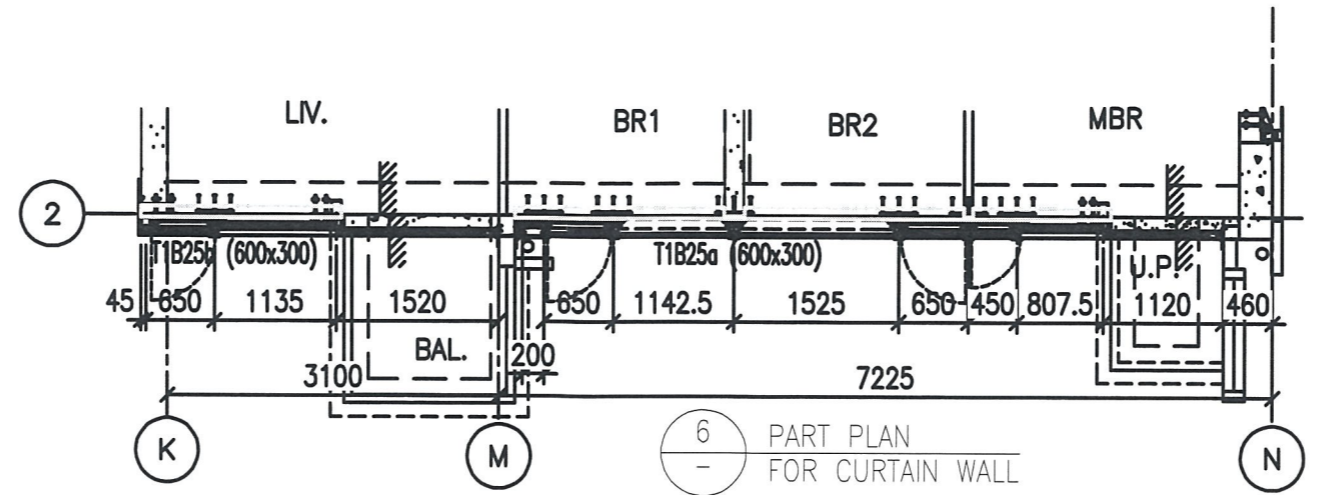

6 PART PLAN FOR CURTAIN WALL

圖號: 837-CW-2113

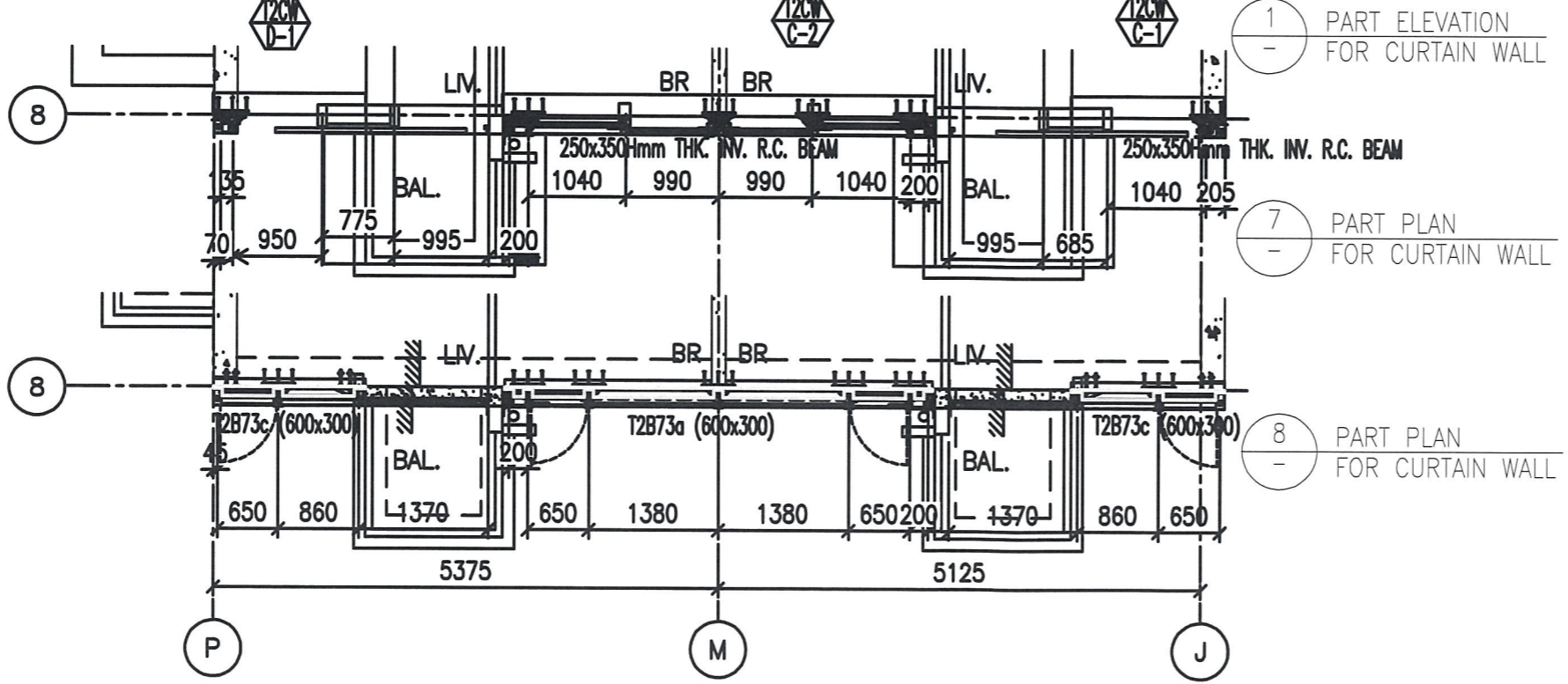
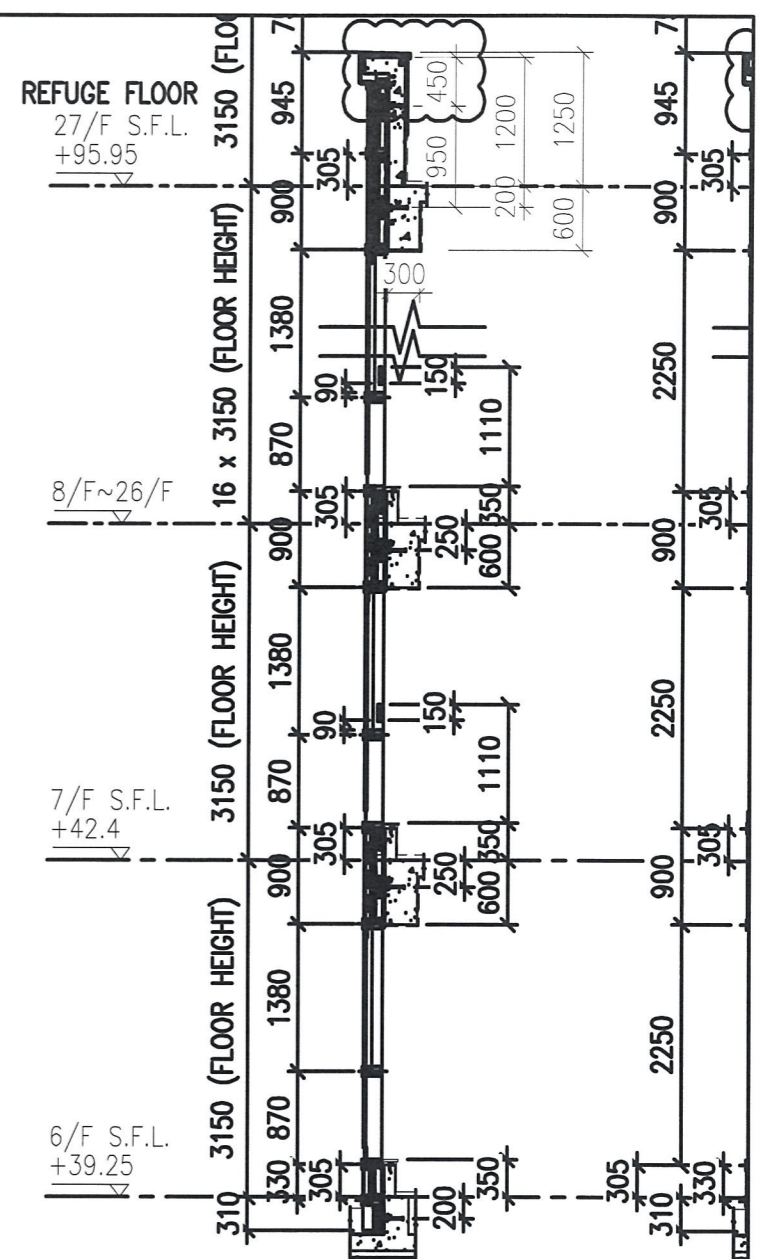
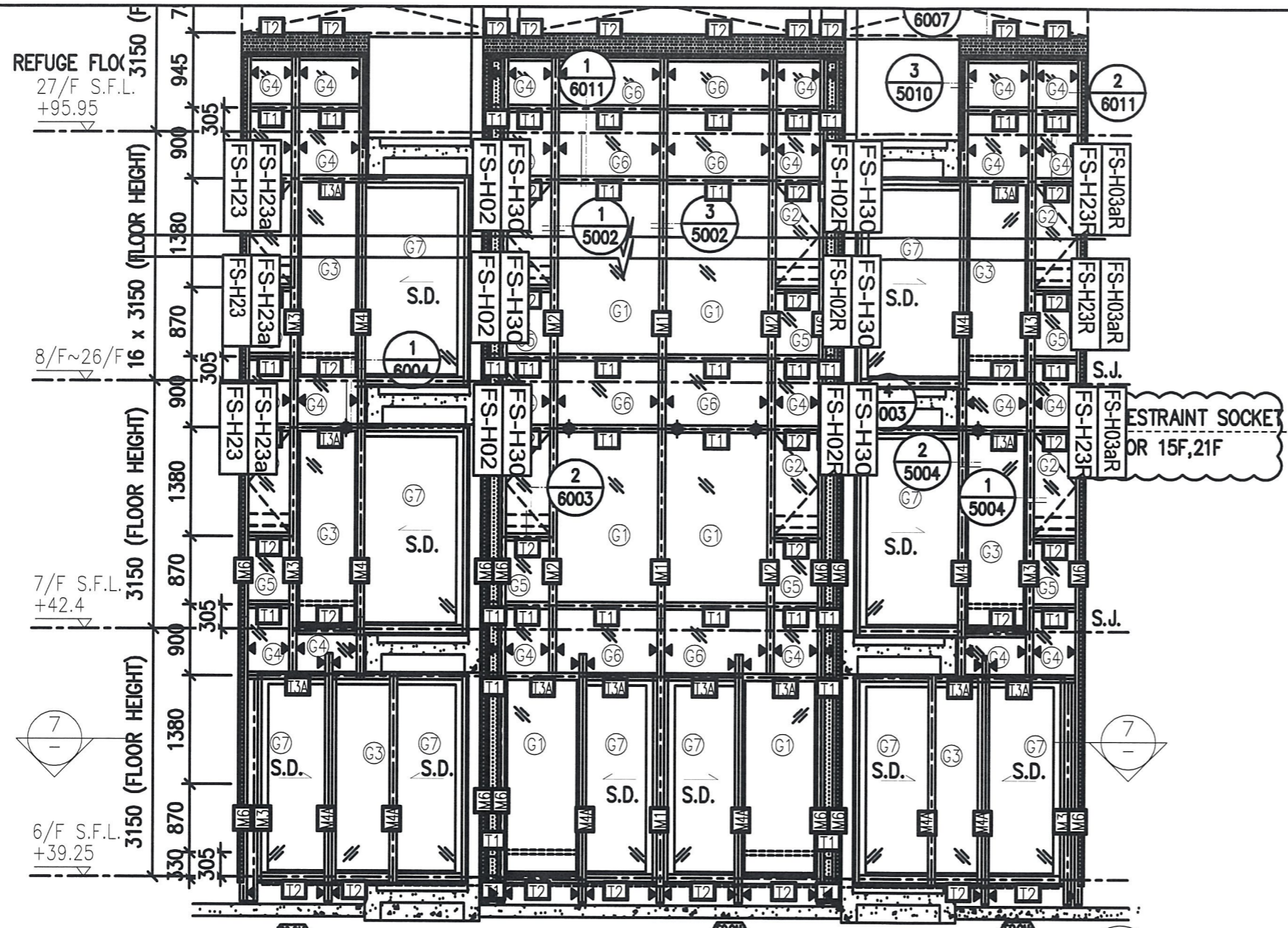

圖號: 837-CW-2205

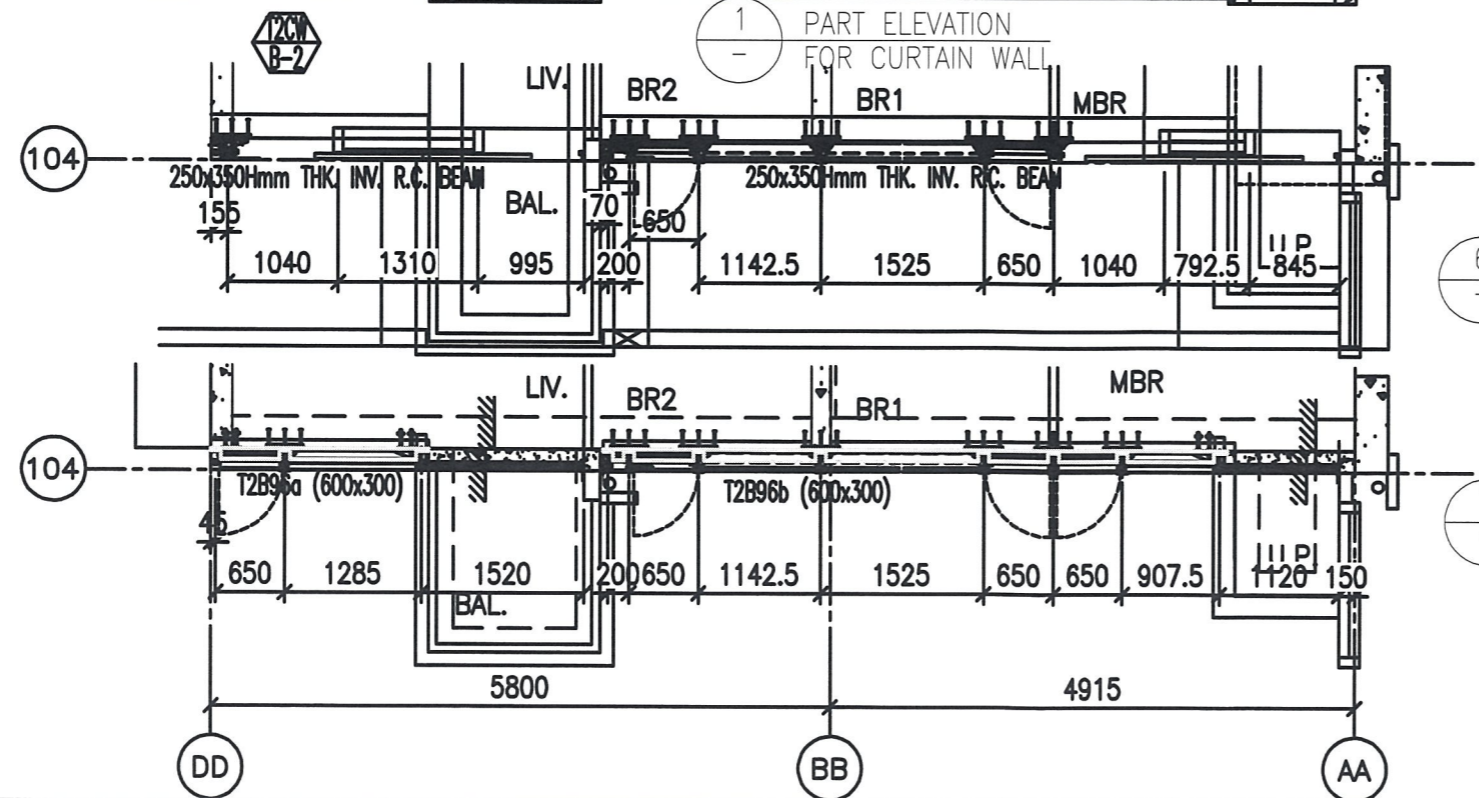
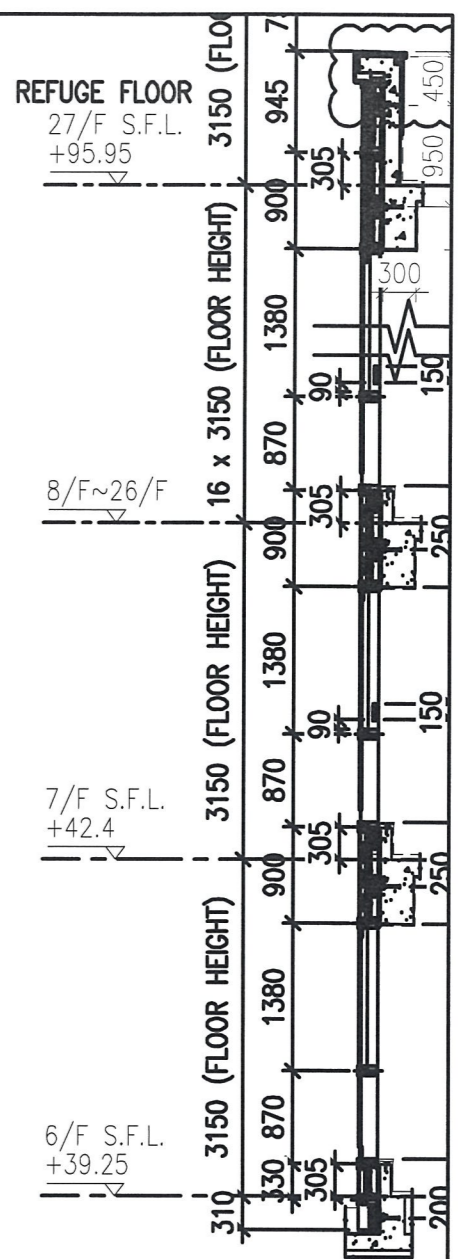
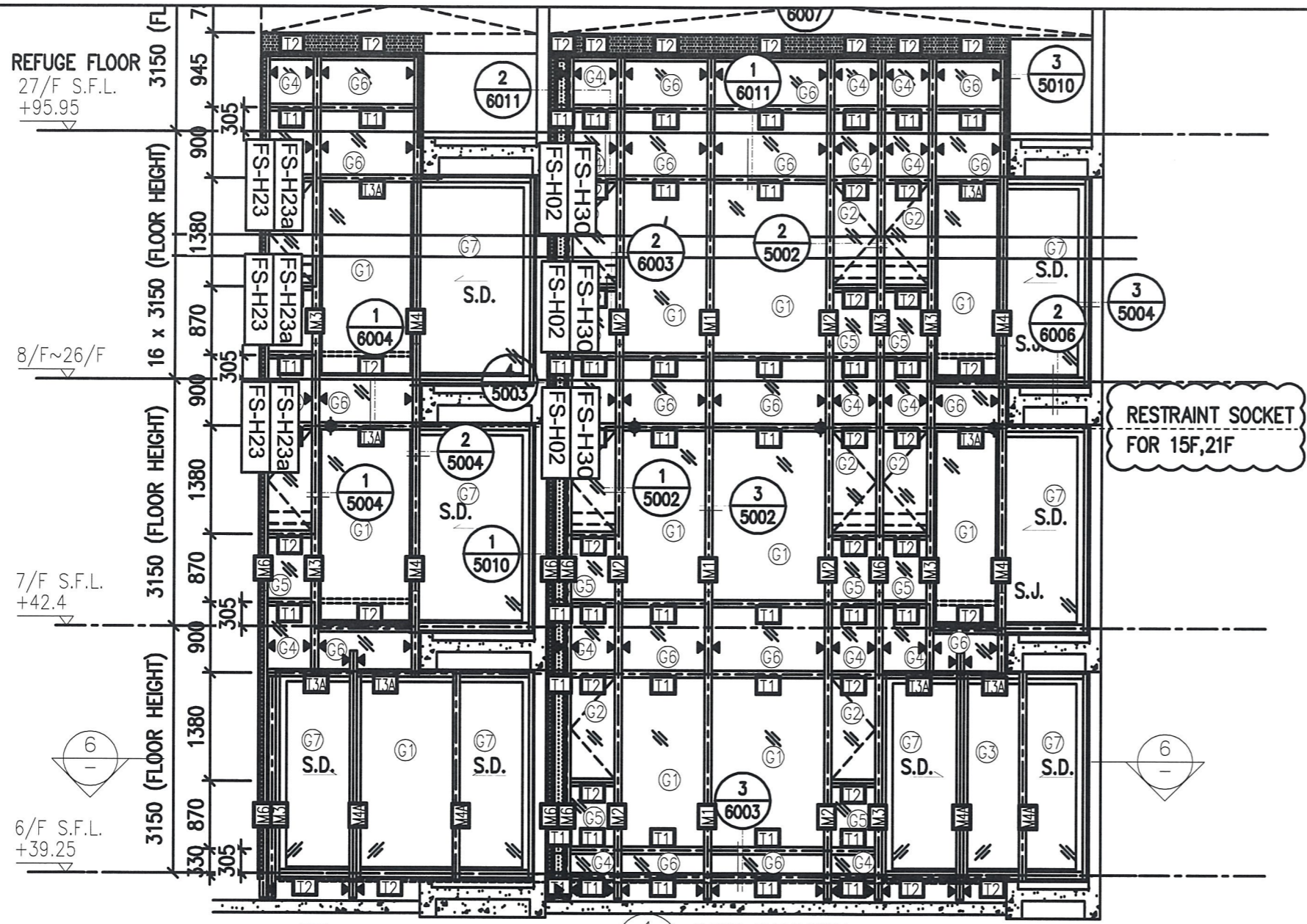

- ② TYPICAL SECTION FOR CURTAIN WALL
- ⑥ PART PLAN FOR CURTAIN WALL
- ⑦ PART PLAN FOR CURTAIN WALL

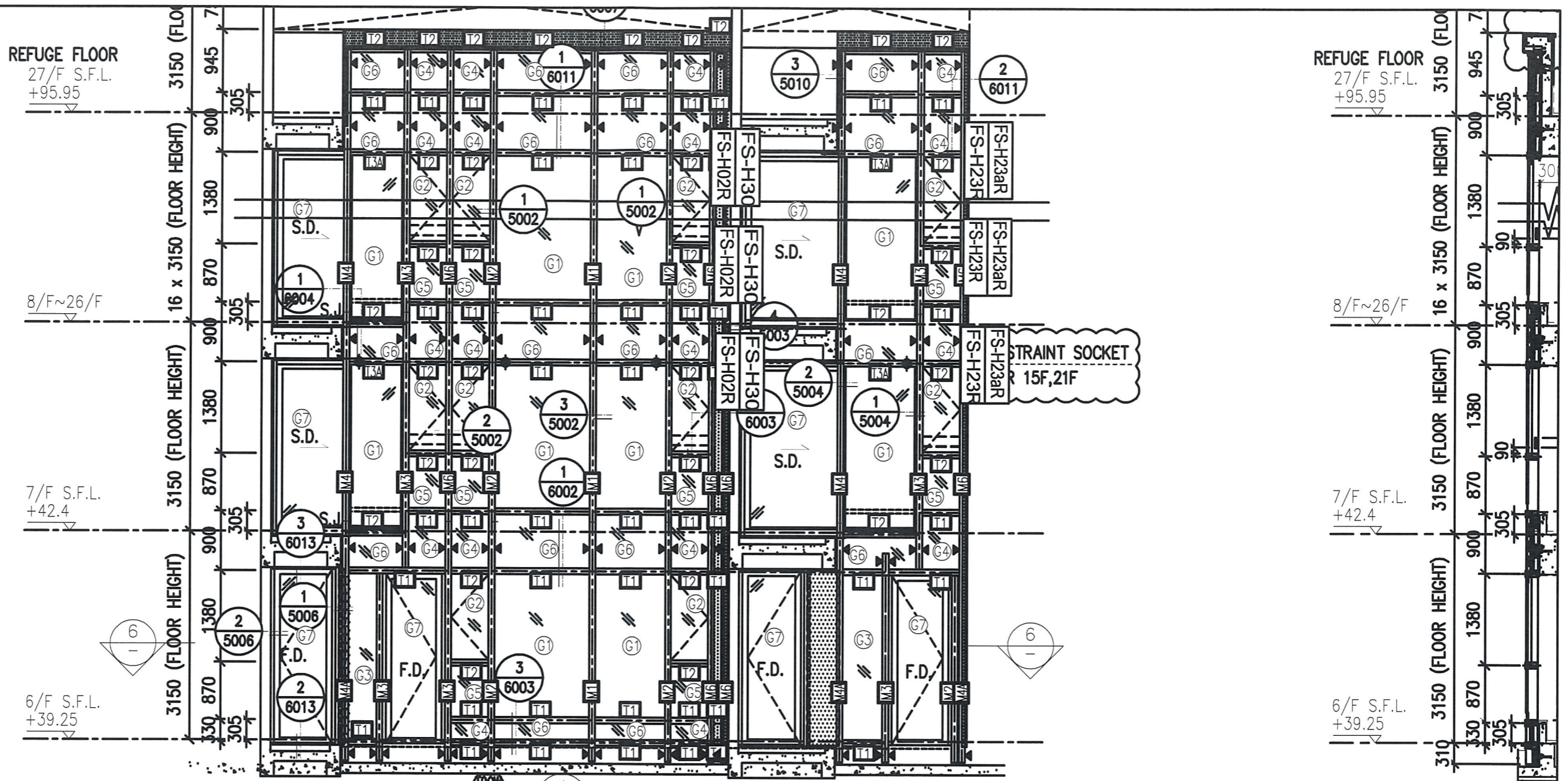

REFUGE FLOOR
27/F S.F.L.
+95.95

REFUGE FLOOR
27/F S.F.L.
+95.95

8/F~26/F

8/F~26/F

7/F S.F.L.
+42.4

7/F S.F.L.
+42.4

6/F S.F.L.
+39.25

6/F S.F.L.
+39.25

1 PART ELEVATION
- FOR CURTAIN WALL

2 TYPICAL SECTION
- FOR CURTAIN WALL

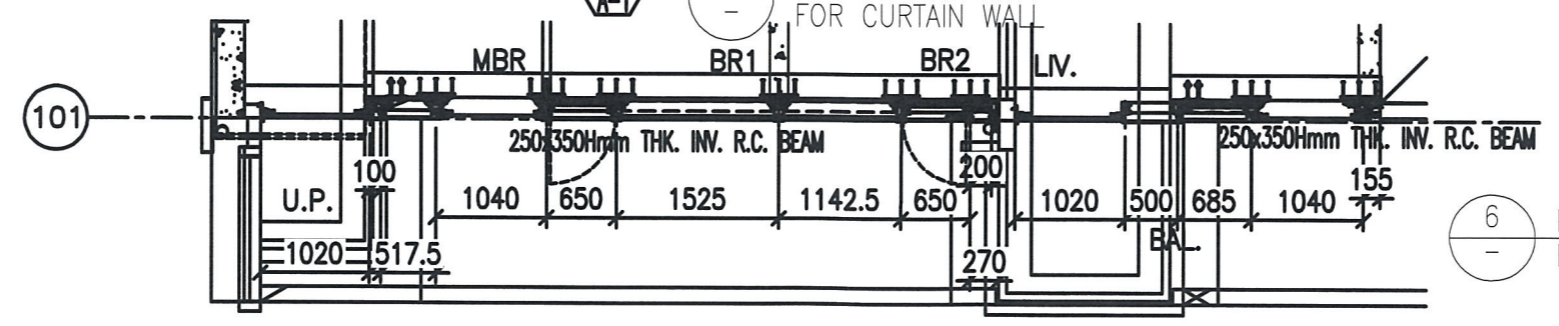

6 PART PLAN
- FOR CURTAIN WALL

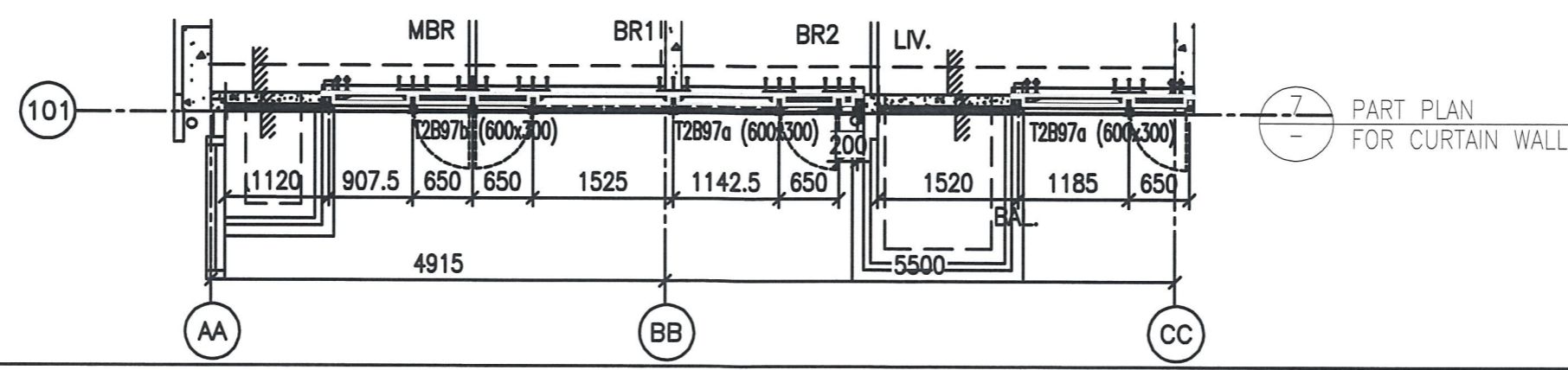

7 PART PLAN
- FOR CURTAIN WALL

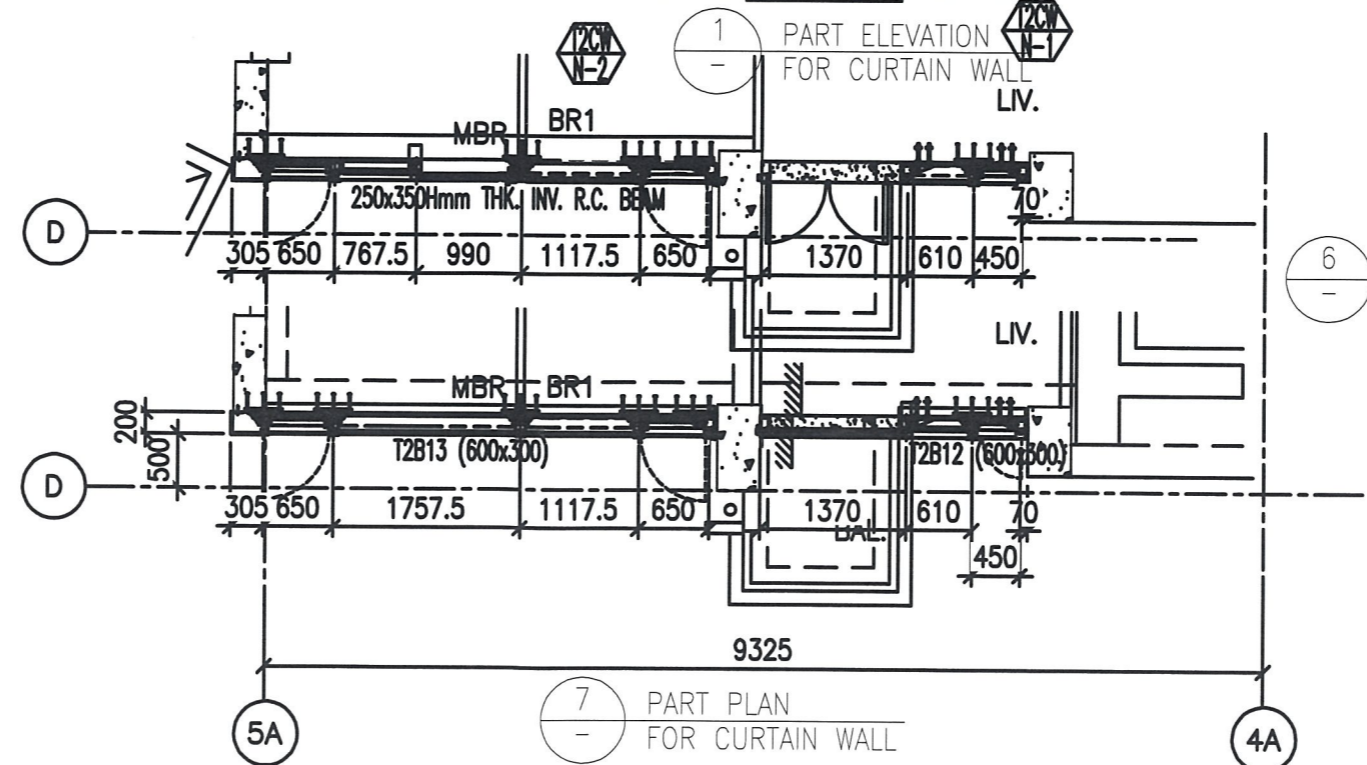
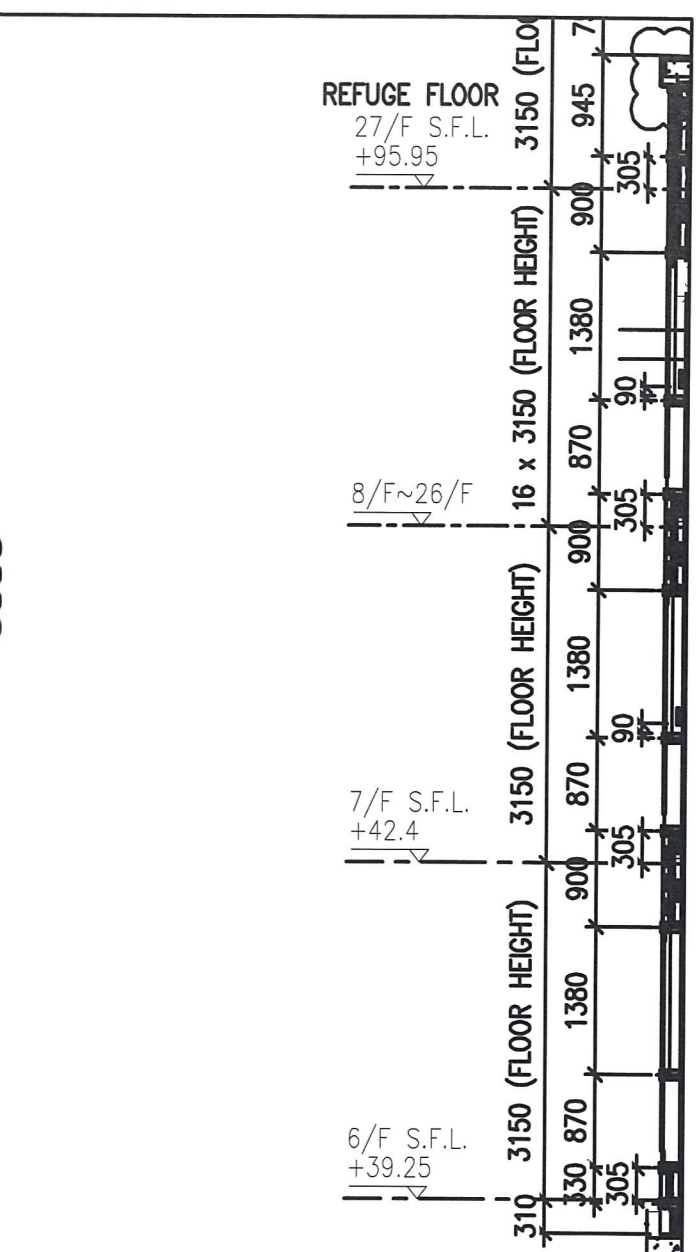
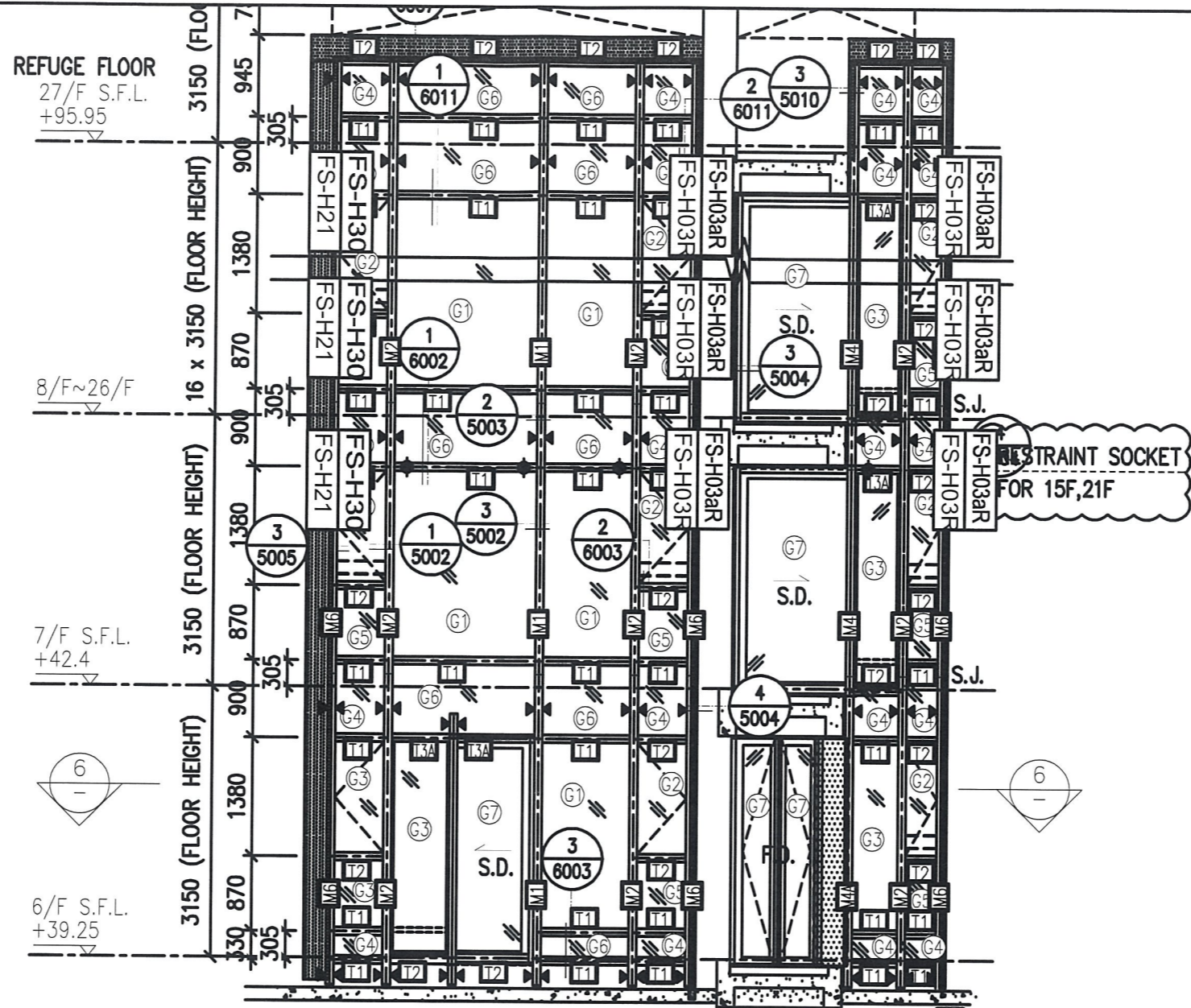

2
-
TYPICAL SECTION FOR CURTAIN WALL

6
-
PART PLAN FOR CURTAIN WALL

7
-
PART PLAN FOR CURTAIN WALL

圖號: 837-CW-2209

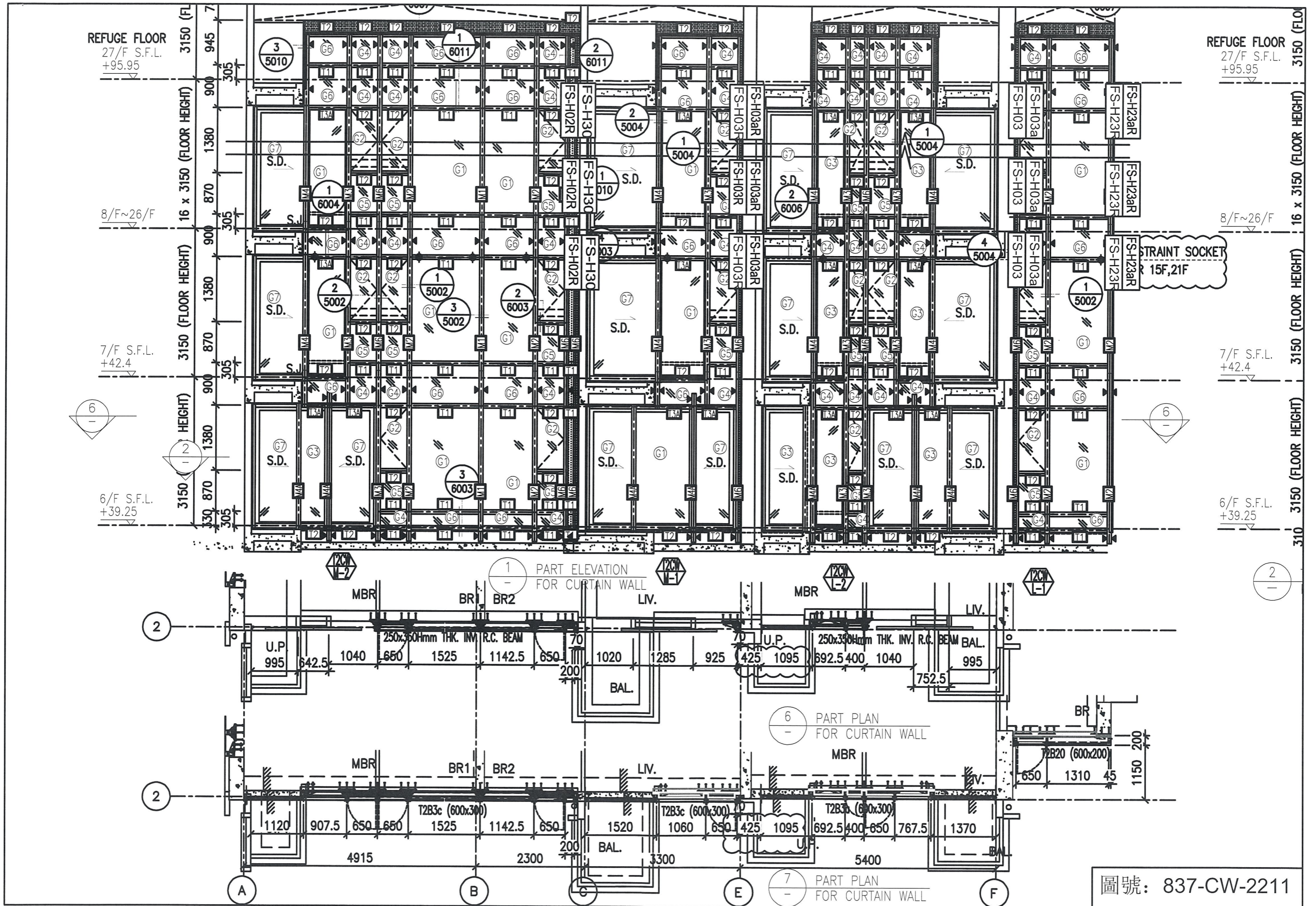

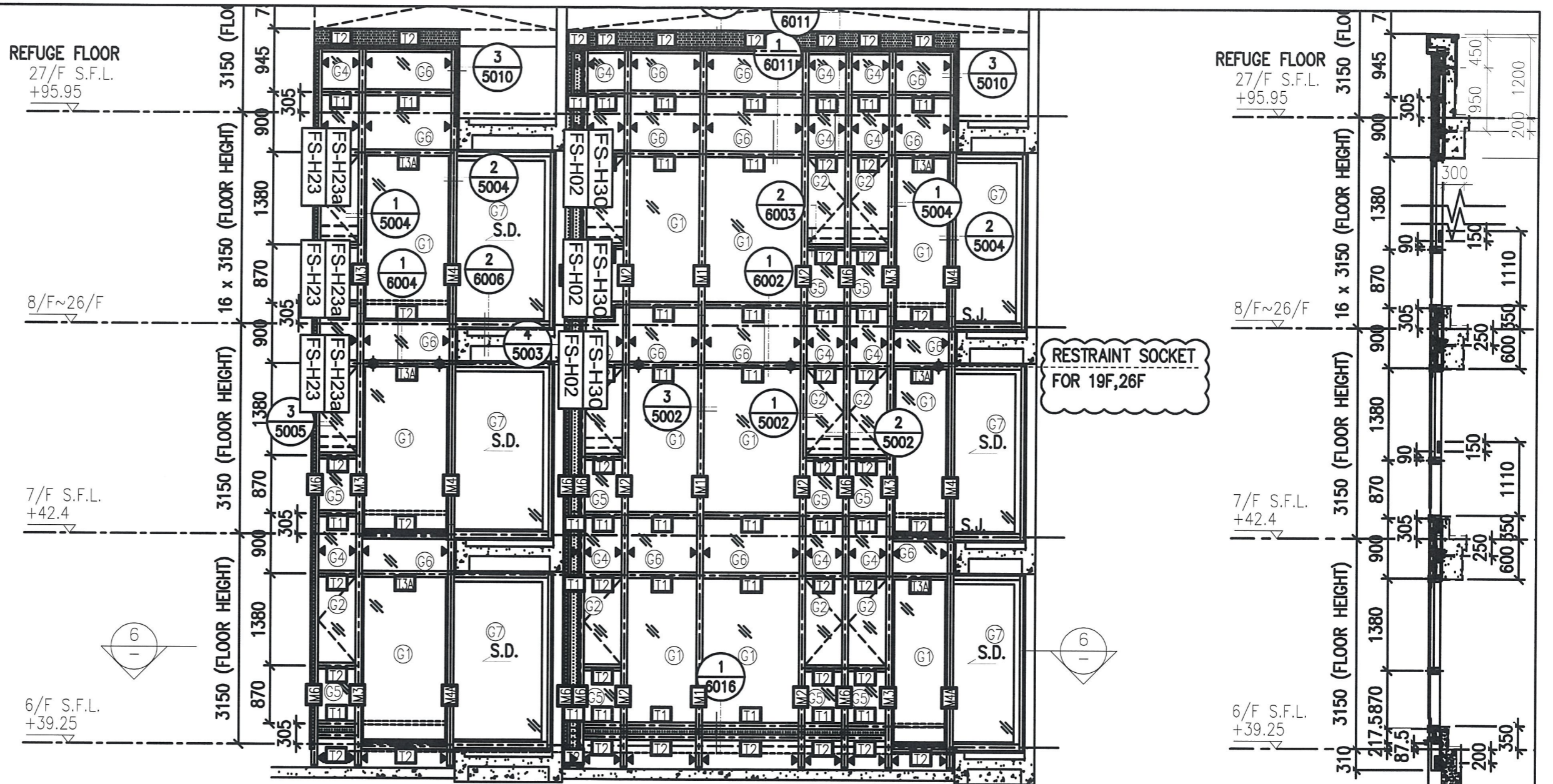

1 PART ELEVATION FOR CURTAIN WALL

2 TYPICAL SECTION FOR CURTAIN WALL

6 PART PLAN FOR CURTAIN WALL

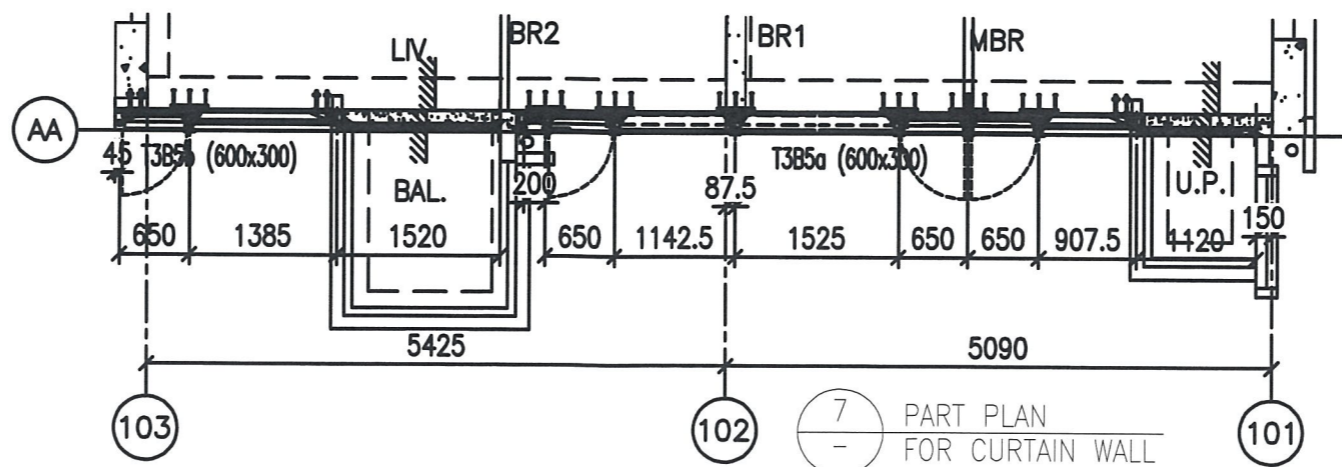

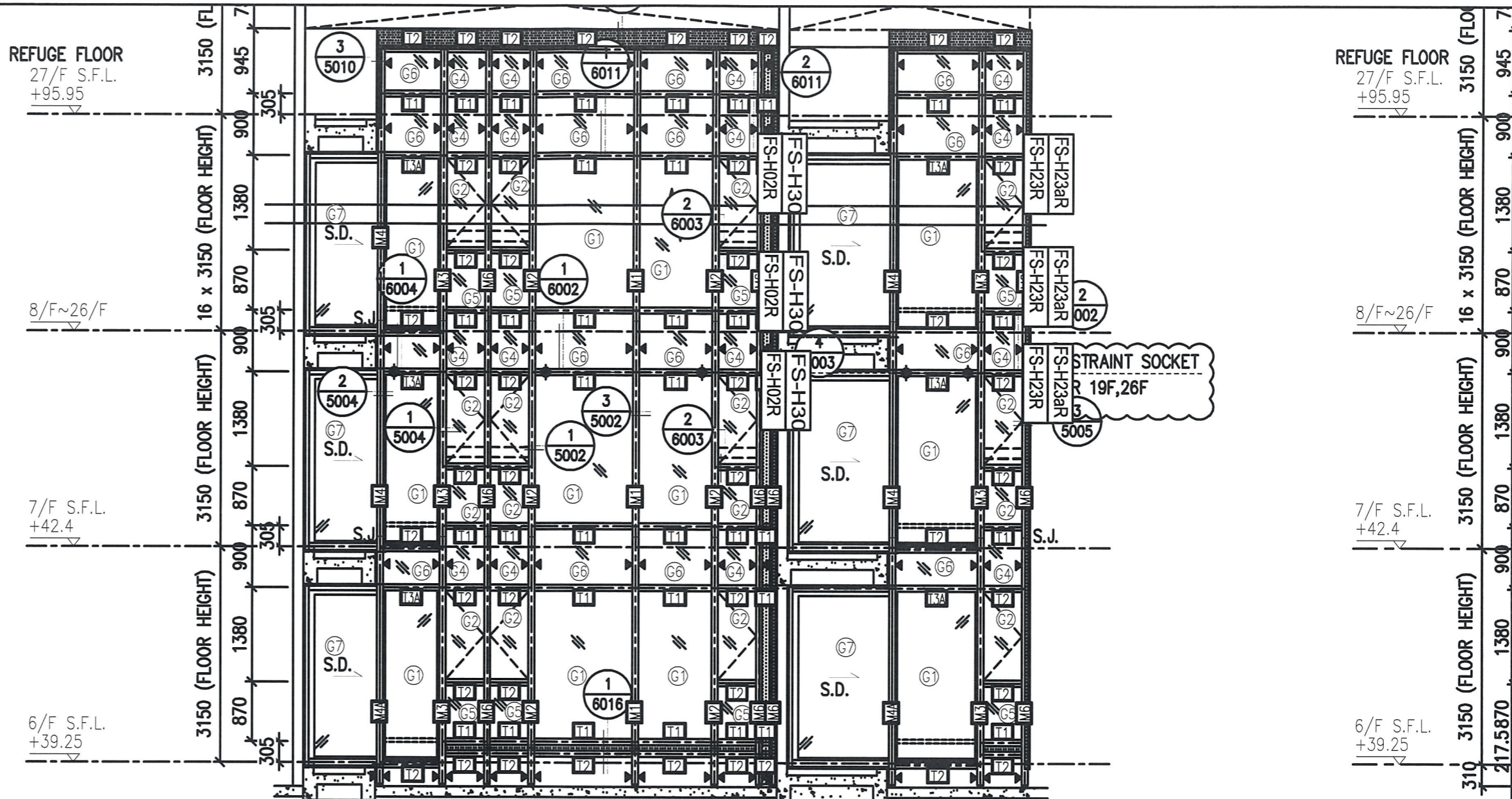

REFUGE FLOOR
27/F S.F.L.
+95.95

REFUGE FLOOR
27/F S.F.L.
+95.95

8/F~26/F

8/F~26/F

7/F S.F.L.
+42.4

7/F S.F.L.
+42.4

6/F S.F.L.
+39.25

6/F S.F.L.
+39.25

1 PART ELEVATION
- FOR CURTAIN WALL

2 TYPICAL SE
- FOR CURTA

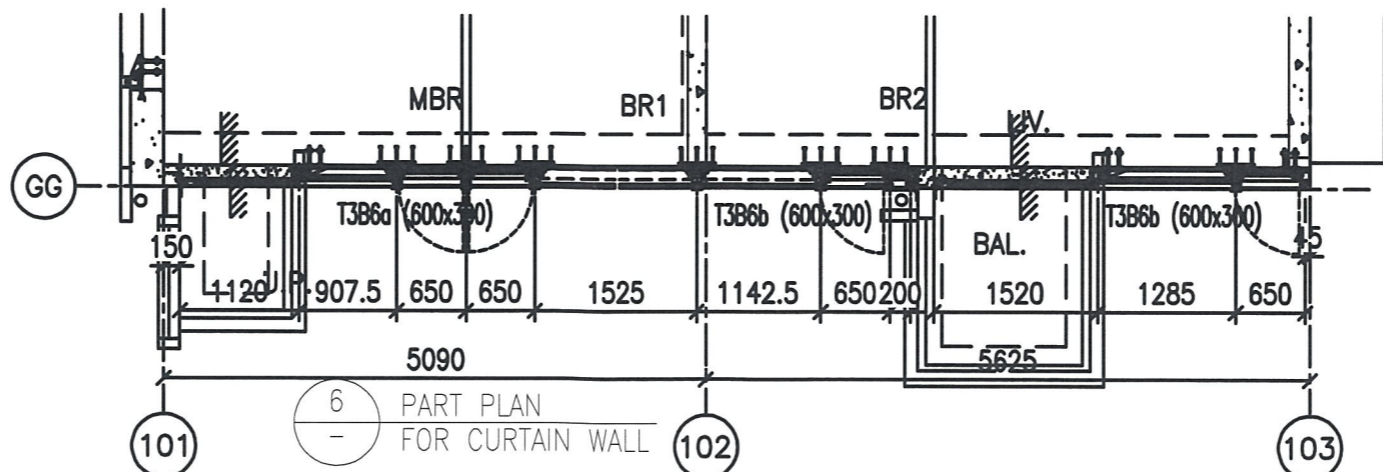

6 PART PLAN
- FOR CURTAIN WALL

圖號: 837-CW-2310

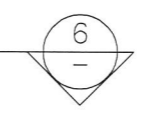
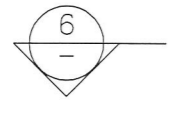
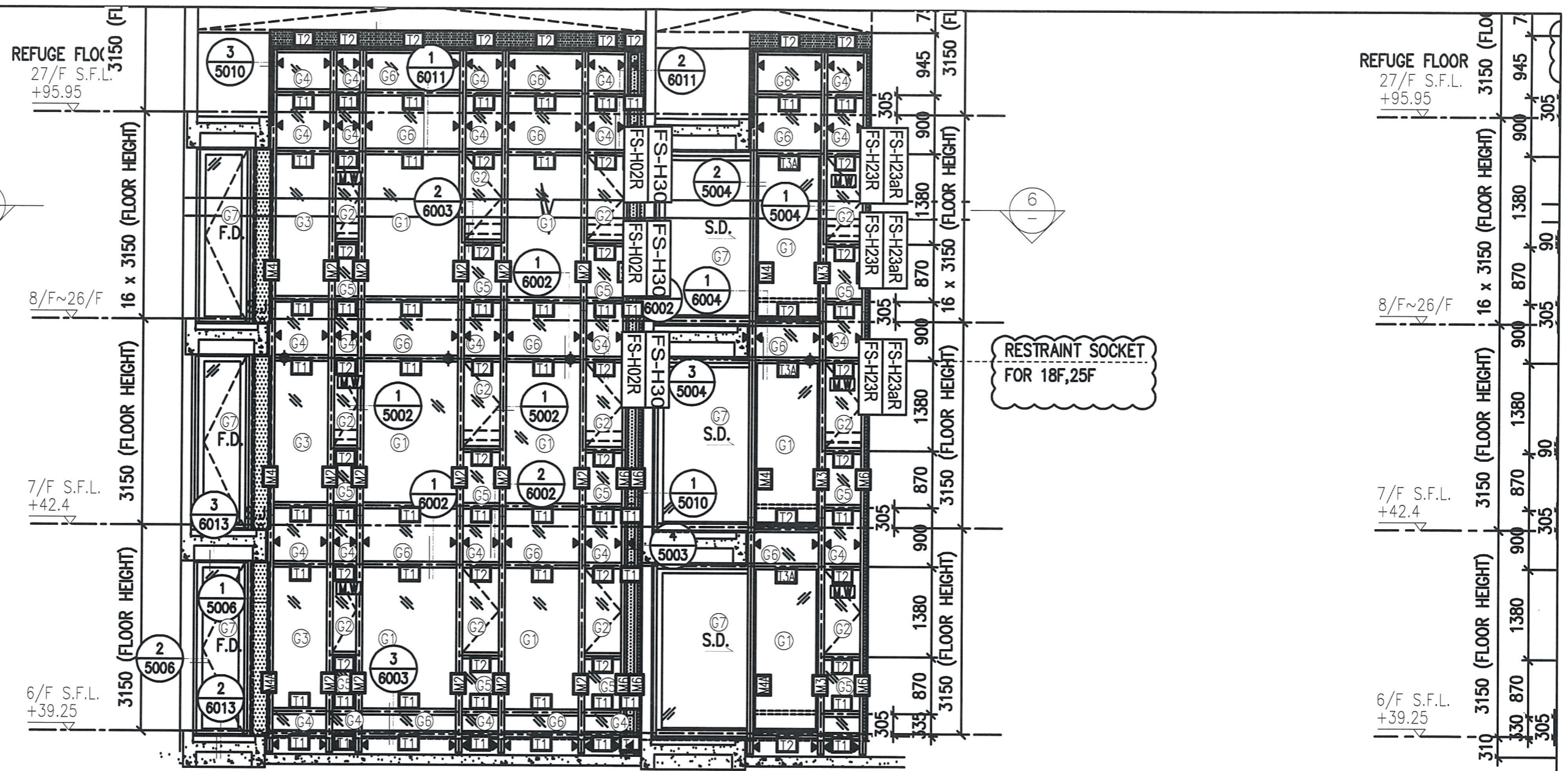

1 PART ELEVATION FOR CURTAIN WALL

2 TYPICAL SECTION FOR CURTAIN

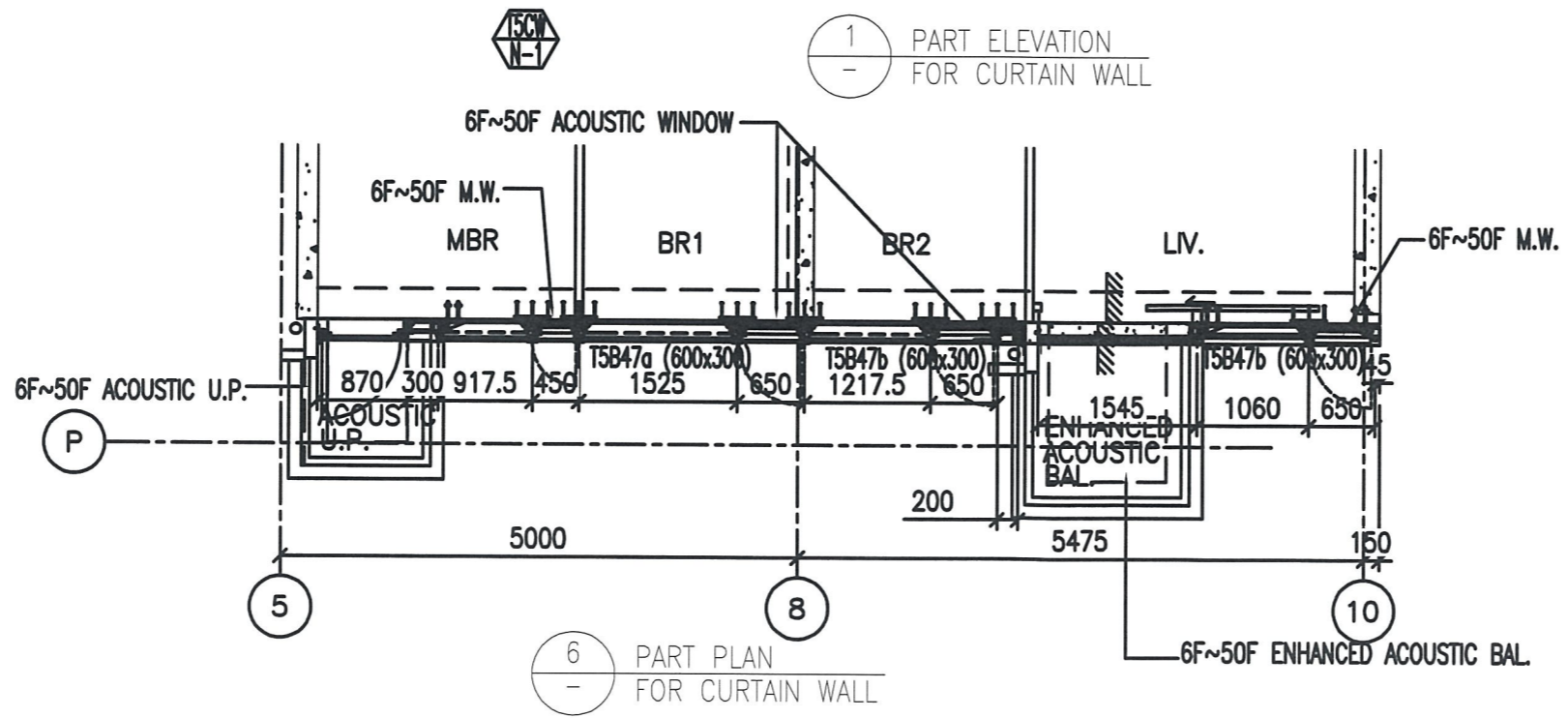

6 PART PLAN FOR CURTAIN WALL

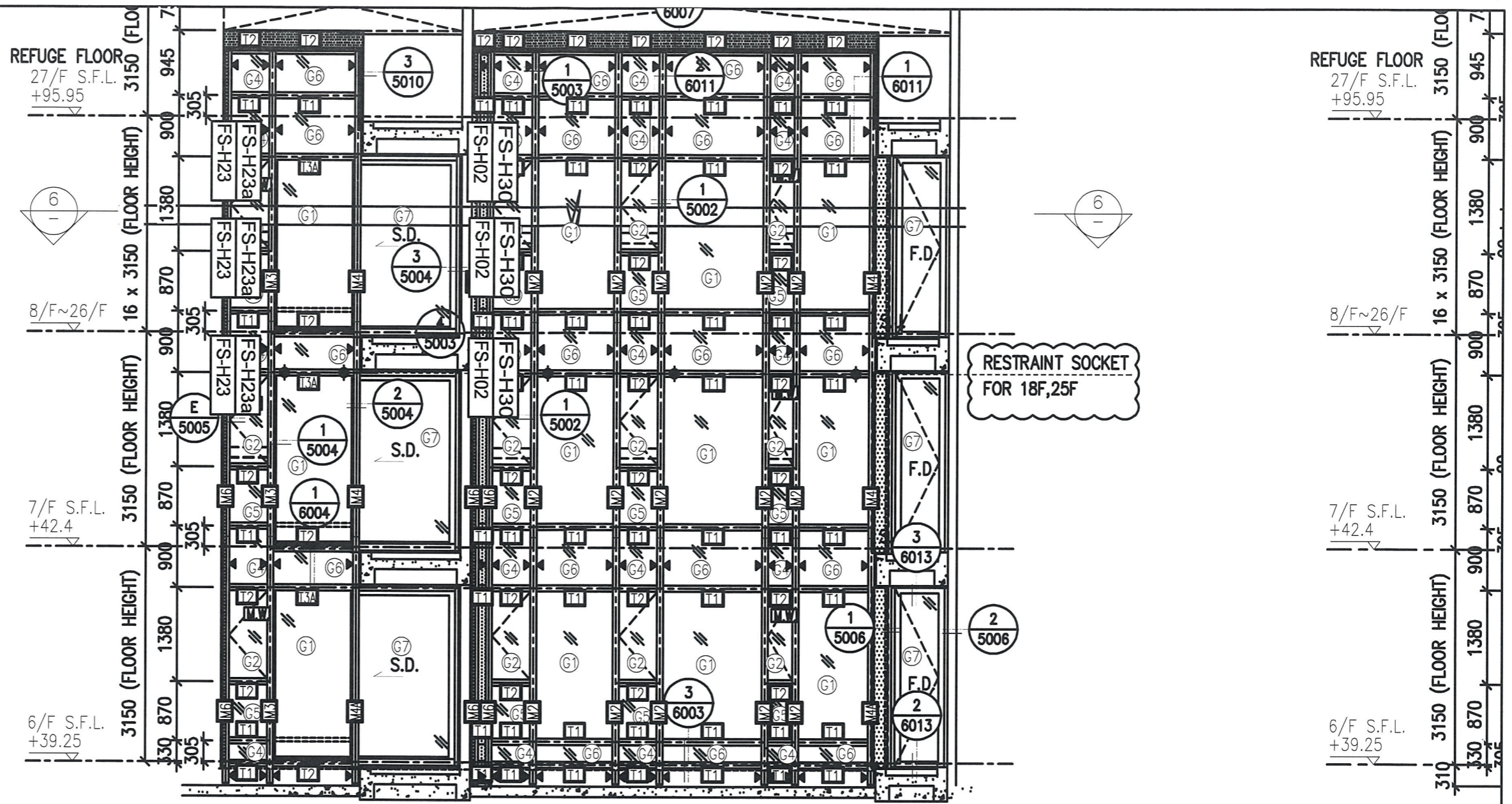

1 PART ELEVATION FOR CURTAIN WALL

2 TYPICAL SECTION FOR CURTAIN WALL

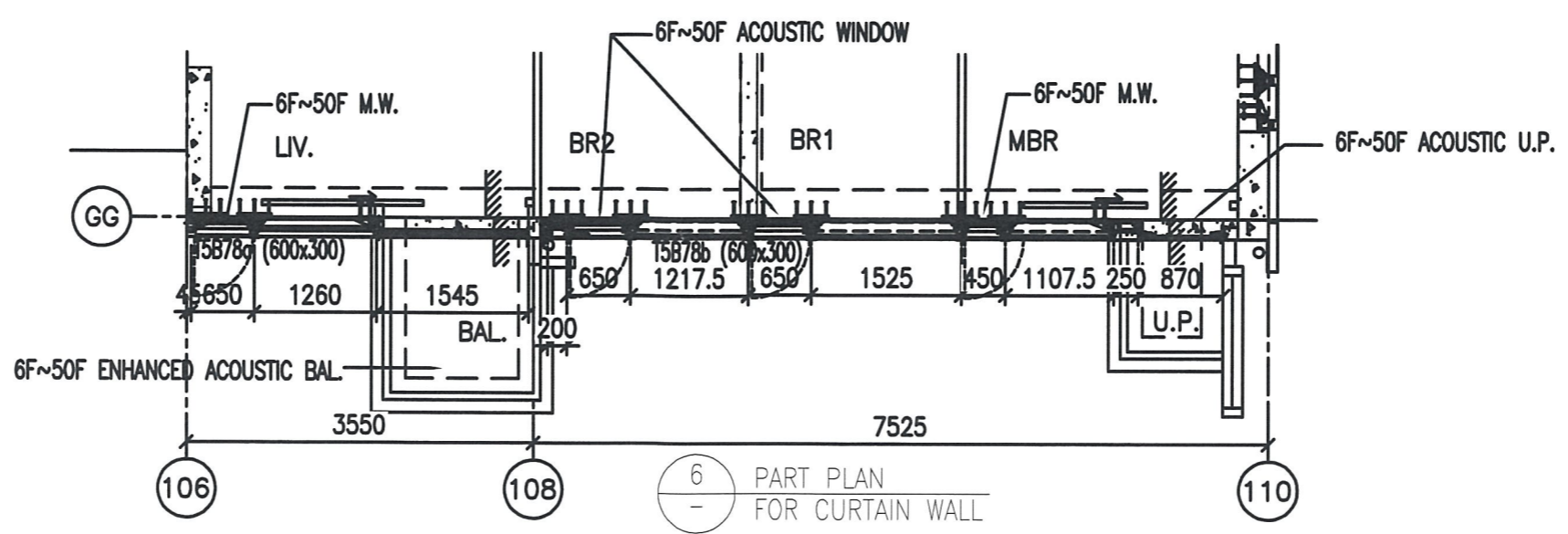

圖號: 837-CW-2503

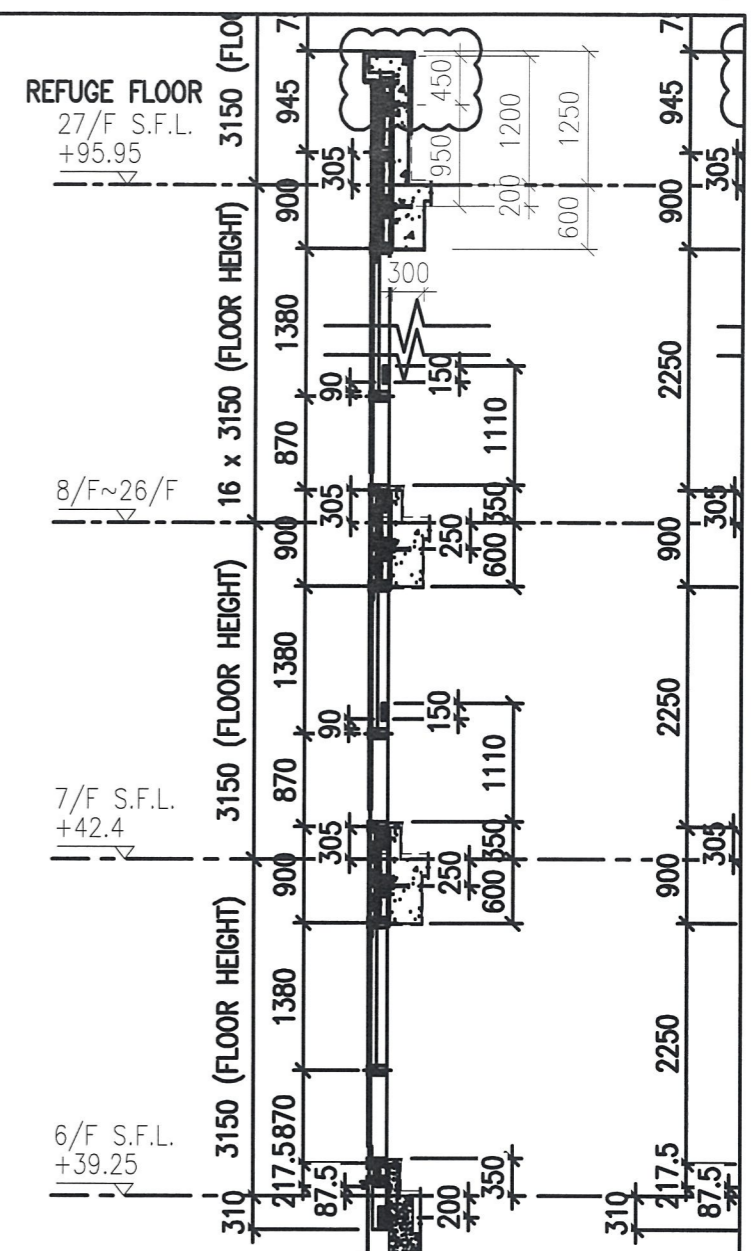
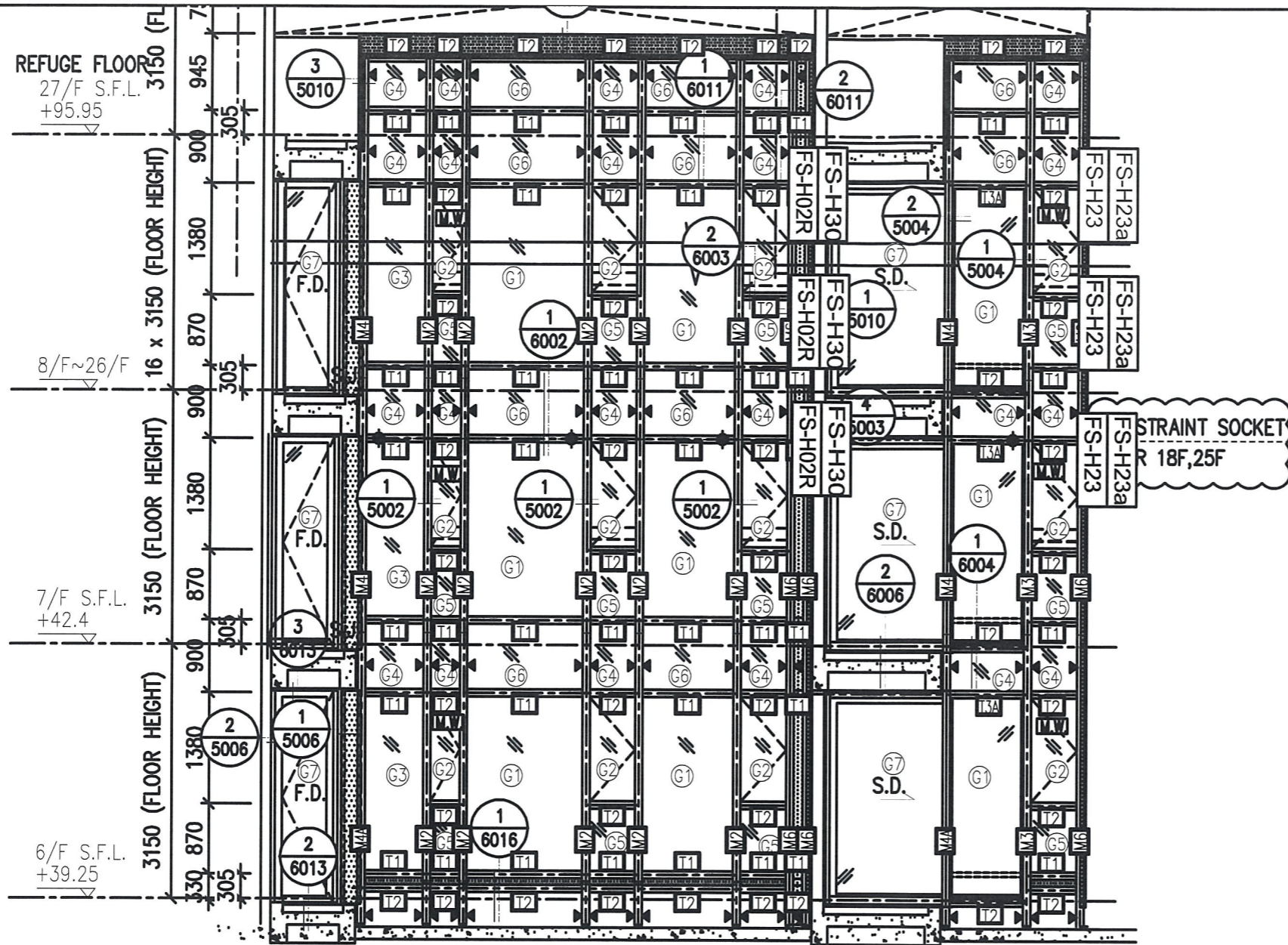

1 PART ELEVATION FOR CURTAIN WALL

2 TYPICAL SECTION FOR CURTAIN WALL

3 TYPICAL SECTION FOR CURTAIN WALL

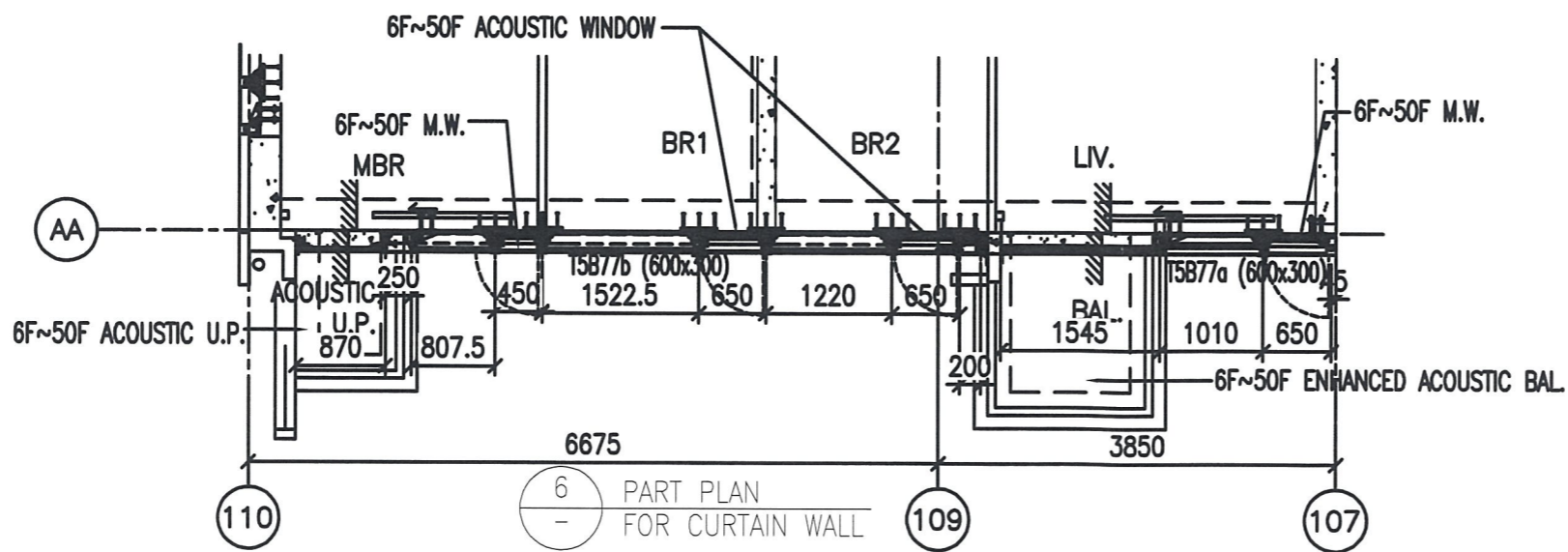

6 PART PLAN FOR CURTAIN WALL

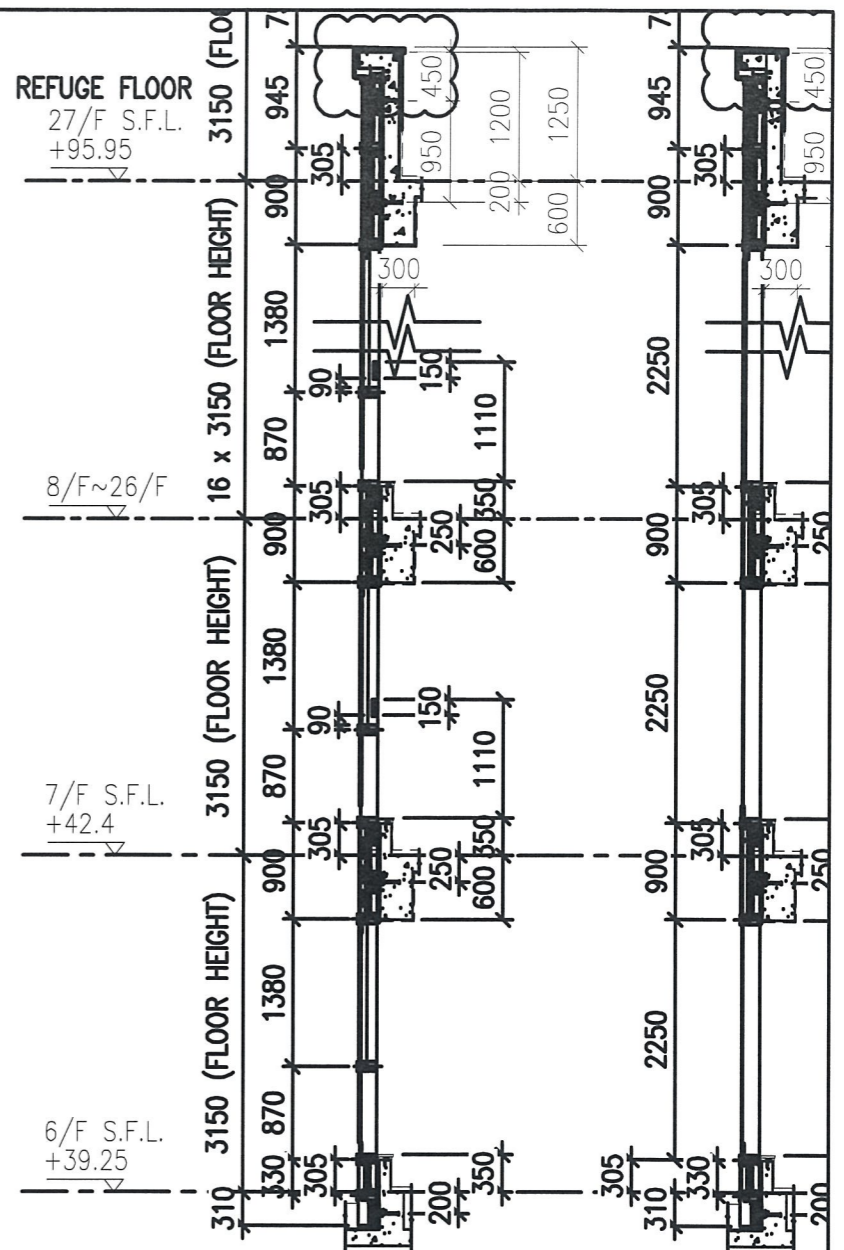
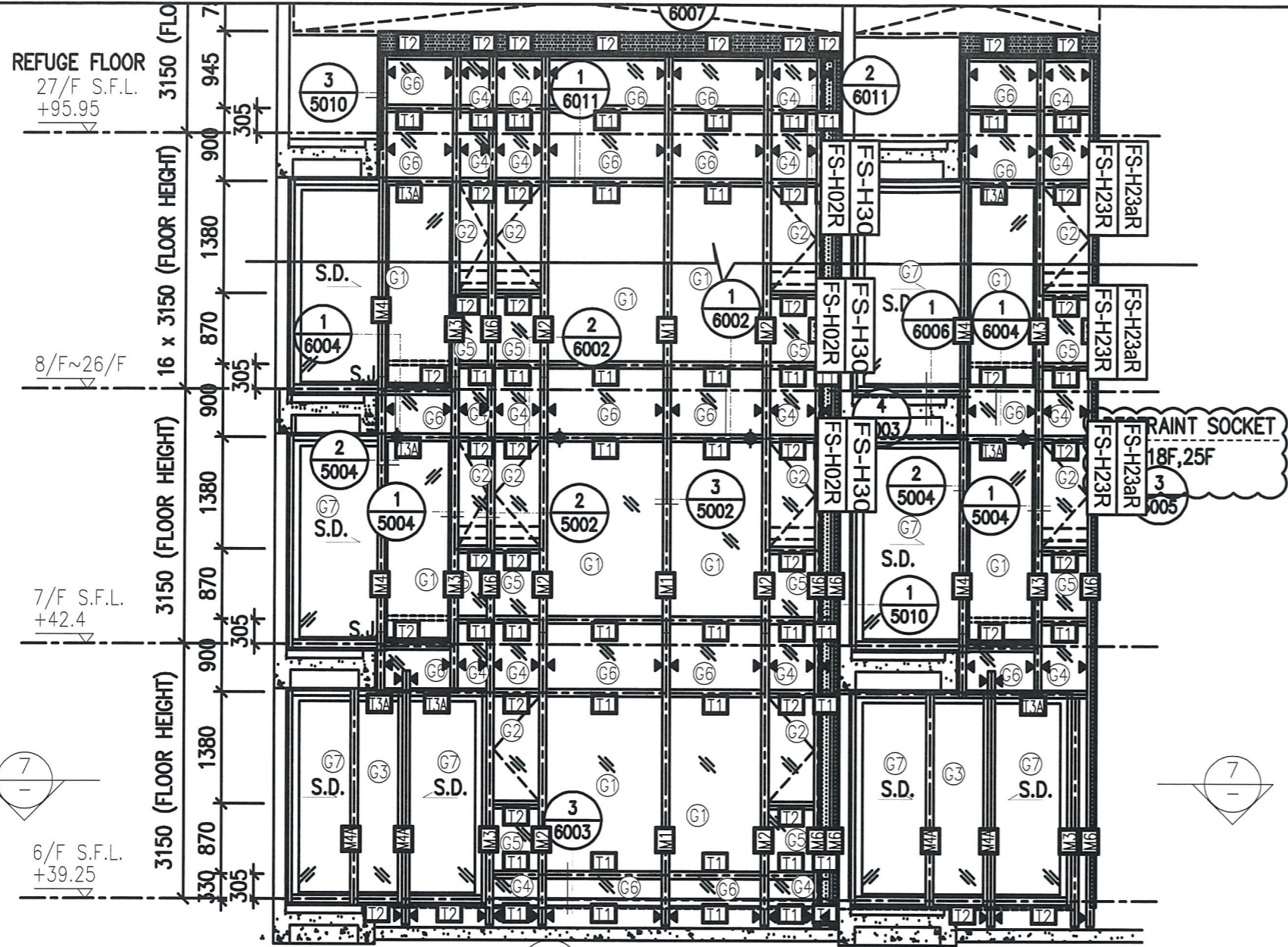

1 PART ELEVATION FOR CURTAIN WALL

2 TYPICAL SECTION FOR CURTAIN WALL

3 TYPICAL SECTION FOR CURTAIN WALL

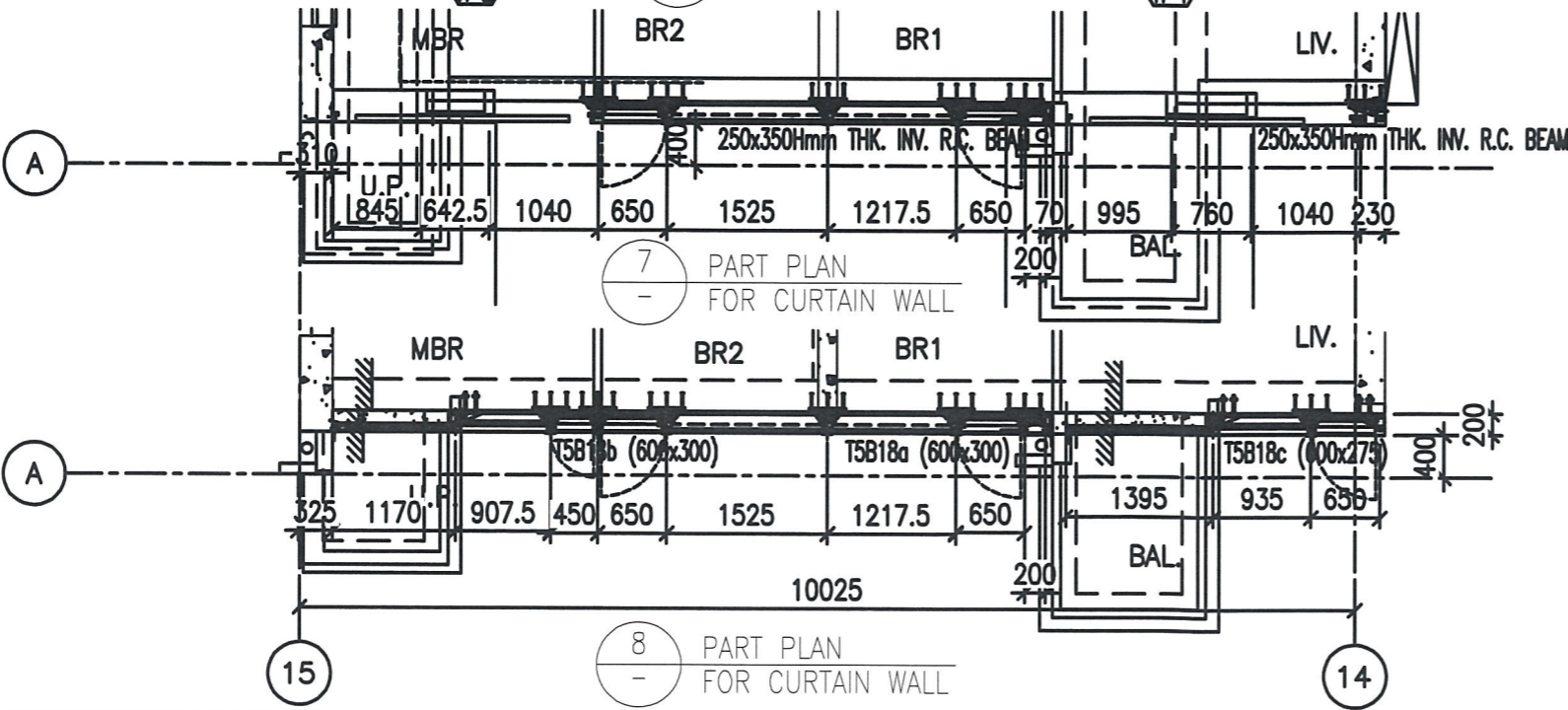

7 PART PLAN FOR CURTAIN WALL

8 PART PLAN FOR CURTAIN WALL

