

工程指示 / 要求簡箋(E.I.)

工程指示編號：EI/ 953B /18 修改版次：
 工程編號：J836 工程名稱：日出康城 7期平台
 工程項目：鋁件樣辦。
 收件人：L 統 發件人：李權翔 日期：2018/7/25

要求提供 / 確認 事項：

- | | | |
|------------------------------------|-------------------------------------|-------------------------------|
| <input type="checkbox"/> 初步鋁料 B.M. | <input type="checkbox"/> 加工折圖，然後生產 | <input type="checkbox"/> 尺寸表 |
| <input type="checkbox"/> 正式鋁料 B.M. | <input type="checkbox"/> 技術上資料 / 指示 | <input type="checkbox"/> 報價 |
| <input type="checkbox"/> 配件 B.M. | <input type="checkbox"/> 樣辦或貨品說明書 | <input type="checkbox"/> 分判合約 |
| <input type="checkbox"/> 其他：_____ | | |

內容：

先前 EI/9395, EI/9497 及 EI/9518 被認了樂陽樓用，
 請於這些 鋁型材到廠後，提供 25mm 長樣辦送到為浩1作
 (每款要 2件)

785516, 785517, 785518, 785519, 785520, 785521, 785522, 785523, 785524, 785525
 785526, 785527, 785528, 785529, 785530, 785531, 785532, 785533, 785534,
 785535, 785537, 785538, 785539.

合共 23 個樣已批核。

請在 2018/8/10 前完成上列要求。

附有關圖紙 / 文件：

23 頁。

以上項目為：

- 原合約工程包 原合約工程加 / 減賬 新工程報價

原因：-

分發東莞各部門：

- () 生產技術總監 連附件 () 技術部 連附件 () 生產部 連附件 () 機械設計部 連附件
 () 採購部 連附件 () 生產統籌部 連附件
 () 質檢部 連附件 () 會計部 連附件 () 報關組 連附件 () 其他 _____ 連附件

分發香港各部門：

- () 行政部 連附件 () 會計部 連附件 () 統籌部 連附件 () 工程部地盤科文 連附件
 () 採購部 連附件 () QS 部 連附件 () 維修部 連附件 () 其他 _____ 連附件

傳遞編號：

HK 1116 / 18

發件人簽署：

項目經理簽署：

CUSTOMER	HONGKONG CO.	CUSTOMER APPROVAL	CUST PART NO.	X85516
			SECTION NO.	LH0089691

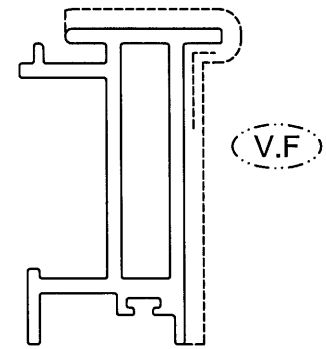
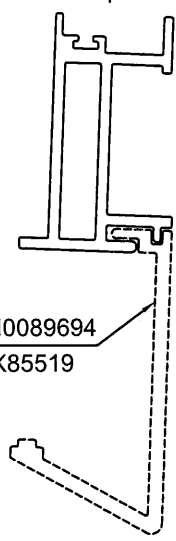
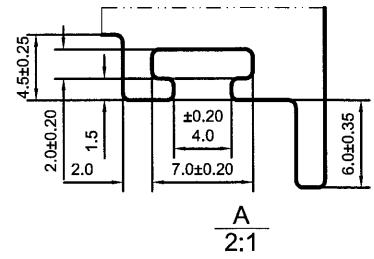
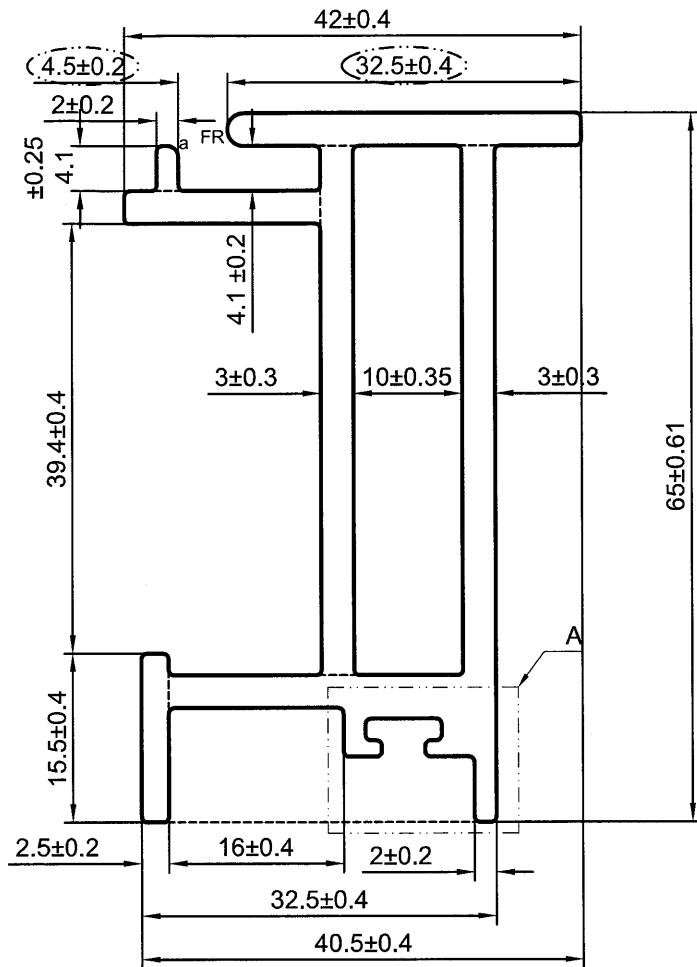

a=R1.0

----- 次要装饰面, 喷涂膜厚不足, 但不露底
 - - - - - 装饰面

*配合尺寸以实物配合效果为准!

SCALE 1:2

SCALE 1:1.5

SIGNATURE GRADEING	HIGH SIGNATURE GRADEING	C.C.DIA(MM)	Ø 76.21						
AREA (SQ MM)	633.43	UNSPECIFIED THICKNESS	3±0.25	PERIMETER (MM)	301.83	STANDARD	GB 5237.1	SCALE	1.5:1
MASS (KG/M)	1.717	UNSPECIFIED CORNERS	R 0.5	SURFACE AREA	108.35	ALLOY	6063-T6	VERSION	A
COMPANY ISSUE		A	DRAWA	蔡晓婷	DATE	2018-05-18	APELLATION	-	PAGE OF
			STANDA-RDIZATION		DATE				
			TO SIGN	陈国提	DATE				
			AUDITING		DATE				
MARKER	MODIFY	FILE NO	SIGNATURE	DATE	APPROV				

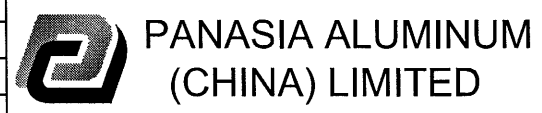

2

CUSTOMER	HONGKONG CO.	CUSTOMER APPROVAL	CUST PART NO.	X85517
			SECTION NO.	LH0089692

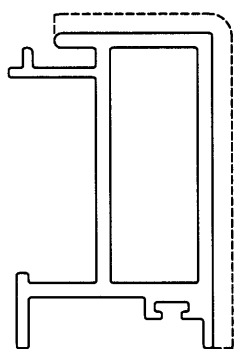
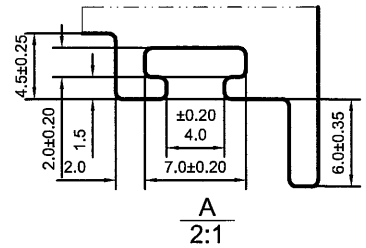
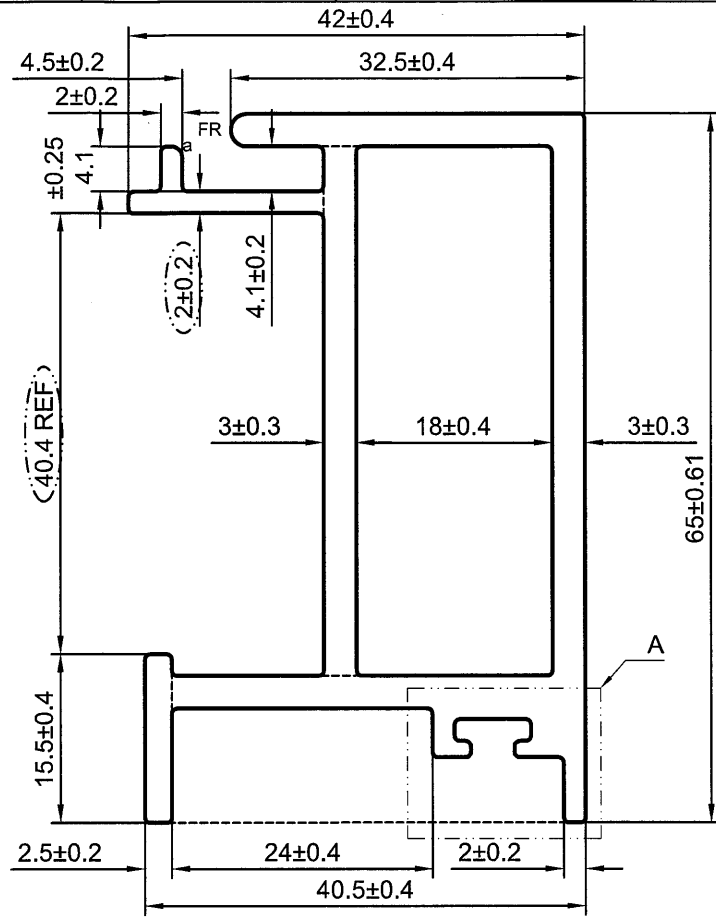

V.F

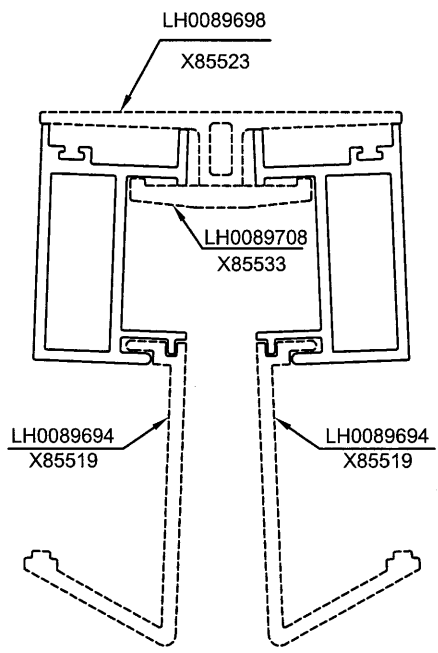

SCALE 1:2

a=R1.0

SCALE 1:1.5

*配合尺寸以实物配合效果为准!

SIGNATURE GRADEING	HIGH SIGNATURE GRADEING	C.C.DIA(MM)	Ø 76.21						
AREA (SQ MM)	639.43	UNSPECIFIED THICKNESS	3±0.25	PERIMETER (MM)	302.26	STANDARD	GB 5237.1	SCALE	1.5:1
MASS (KG/M)	1.733	UNSPECIFIED CORNERS	R 0.5	SURFACE AREA	100.78	ALLOY	6063-T6	VERSION	B
COMPANY ISSUE		B	DRAWA	蔡晓婷	DATE	2018-06-25	APELLATION	-	PAGE OF
			STANDARDIZATION		DATE				
			TO SIGN	陈国提	DATE				
			AUDITING		DATE				
MARKER	MODIFY	FILE NO	SIGNATURE	DATE	APPROV				

CUSTOMER	HONGKONG CO.	CUSTOMER APPROVAL	CUST PART NO.	X85518
			SECTION NO.	LH0089693

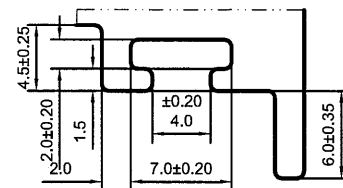
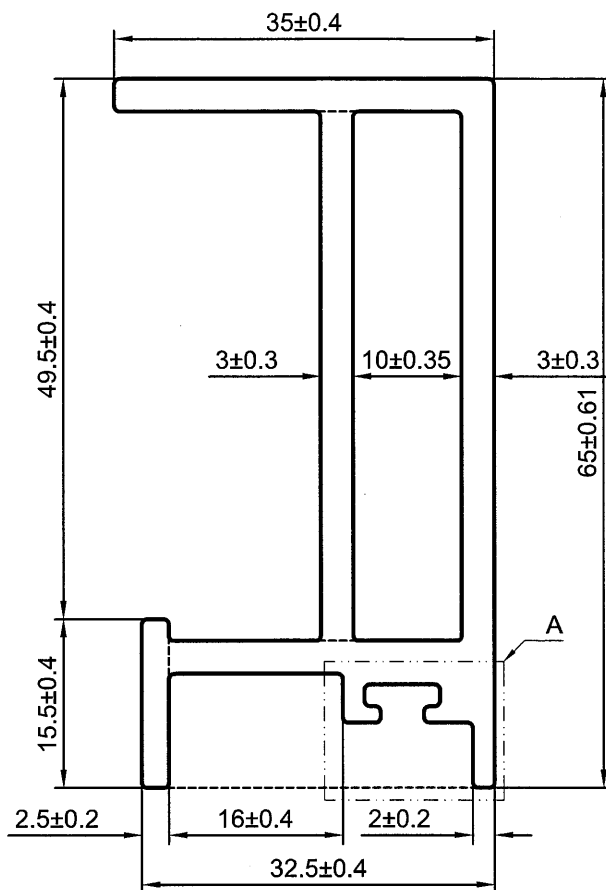

A
2:1

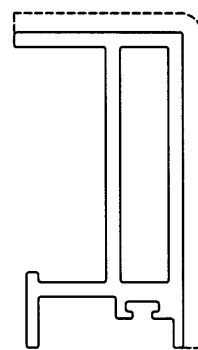

V.F

SCALE 1:1.5

*配合尺寸以实物配合效果为准!

SIGNATURE GRADEING	HIGH SIGNATURE GRADEING	C.C.DIA(MM)	Ø 73.47						
AREA (SQ MM)	579.75	UNSPECIFIED THICKNESS	3±0.25	PERIMETER (MM)	265.85	STANDARD	GB 5237.1	SCALE	1.5:1
MASS (KG/M)	1.571	UNSPECIFIED CORNERS	R 0.5	SURFACE AREA	100.36	ALLOY	6063-T6	VERSION	A
COMPANY ISSUE		A	DRAWN	蔡晓婷	DATE	2018-05-17	APELLATION	-	PAGE OF
			STANDARDIZATION		DATE				
			TO SIGN	陈国提	DATE				
			AUDITING		DATE				
MARKER	MODIFY	FILE NO	SIGNATURE	DATE	APPROV				

CUSTOMER	HONGKONG CO.	CUSTOMER APPROVAL		CUST PART NO.	X85519
				SECTION NO.	LH0089694

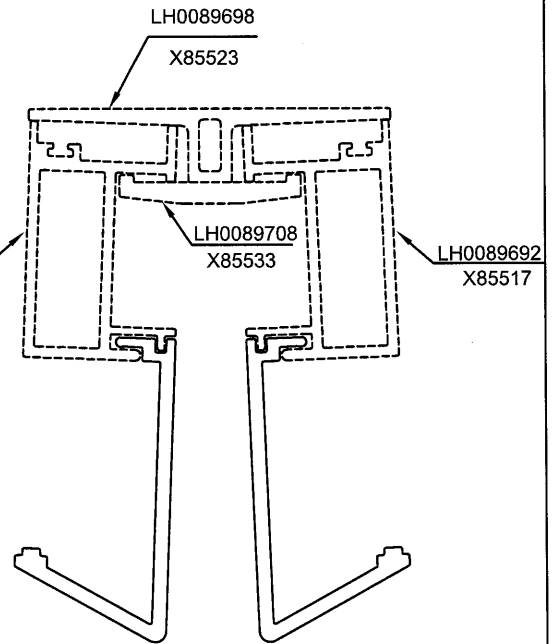
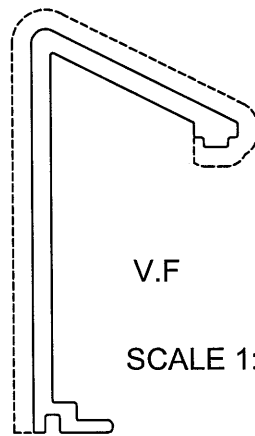
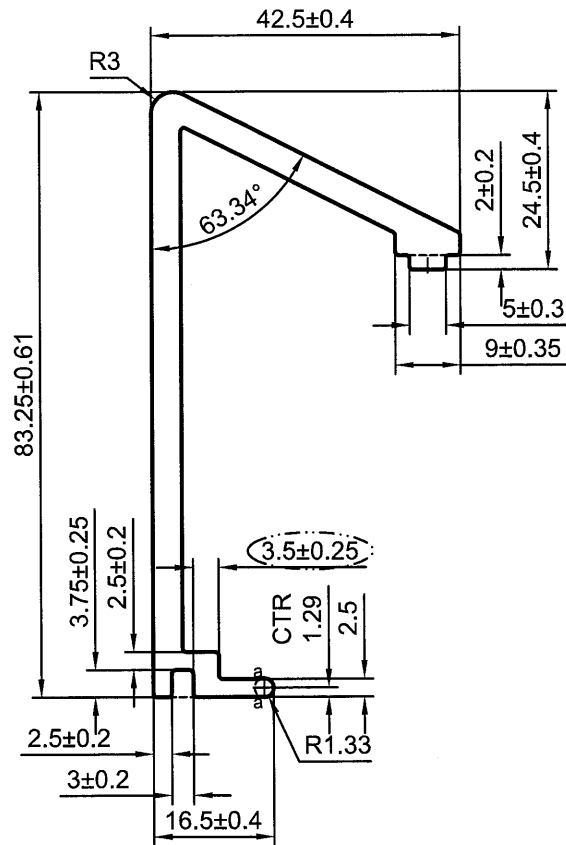

a=R0.8

*配合尺寸以实物配合效果为准!

SIGNATURE GRADEING	HIGH SIGNATURE GRADEING	C.C.DIA(MM)	Ø 84.23						
AREA (SQ MM)	558.81	UNSPECIFIED THICKNESS	4±0.25	PERIMETER (MM)	291.55	STANDARD	GB 5237.1	SCALE	1:1
MASS (KG/M)	1.514	UNSPECIFIED CORNERS	R 0.5	SURFACE AREA	144.50	ALLOY	6063-T6	VERSION	A
COMPANY ISSUE		A	DRAWA	蔡晓婷	DATE	2018-05-17	APELLATION	-	PAGE OF
			STANDA-RDIZATION		DATE				
			TO SIGN	陈国提	DATE				
			AUDITING		DATE				
MARKER	MODIFY	FILE NO	SIGNATURE	DATE	APPROV				

 PANASIA ALUMINUM (CHINA) LIMITED

CUSTOMER	HONGKONG CO.	CUSTOMER APPROVAL	CUST PART NO.	X85520
			SECTION NO.	LH0089695

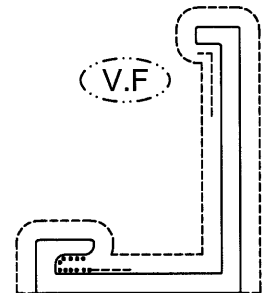
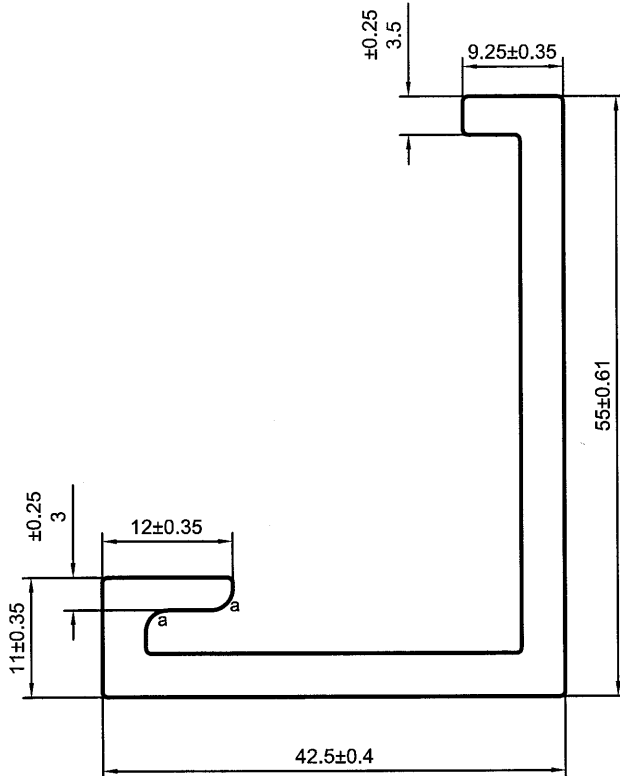

SCALE 1:1.5

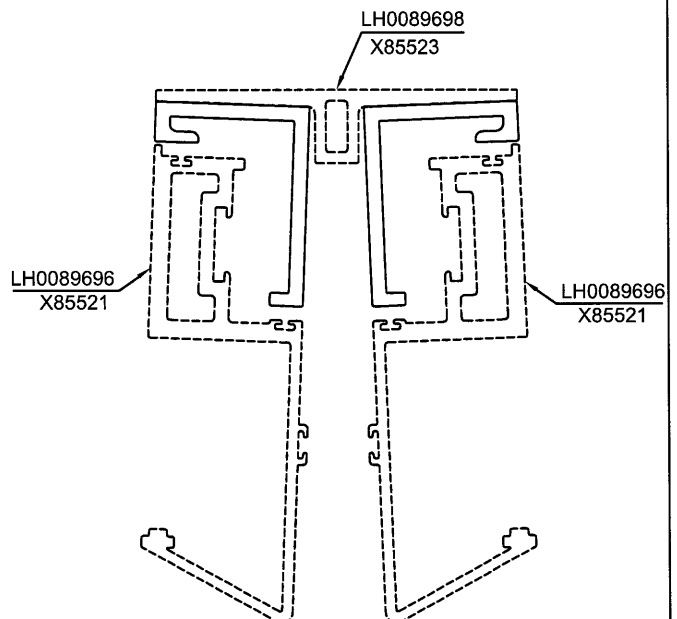

a=R2

- 次要装饰面, 喷涂膜厚不足, 但不露底
- 装饰面
- 凹槽位置可能会有露底现象, 即膜厚不足

*配合尺寸以实物配合效果为准!

SIGNATURE GRADEING	HIGH SIGNATURE GRADEING	C.C.DIA(MM)	Ø 69.1						
AREA (SQ MM)	444.16	UNSPECIFIED THICKNESS	4±0.25	PERIMETER (MM)	231.64	STANDARD	GB 5237.1	SCALE	1.5:1
MASS (KG/M)	1.204	UNSPECIFIED CORNERS	R 0.5	SURFACE AREA	190.14	ALLOY	6063-T6	VERSION	A
COMPANY ISSUE		A	DRAWN	蔡晓婷	DATE	2018-05-17	APELLATION	-	PAGE OF
			STANDARDIZATION		DATE				
			TO SIGN	陈国提	DATE				
			AUDITING		DATE				
MARKER	MODIFY	FILE NO	SIGNATURE	DATE	APPROV				



b

CUSTOMER	HONGKONG CO.	CUSTOMER APPROVAL	CUST PART NO.	X85521
			SECTION NO.	LH0089696

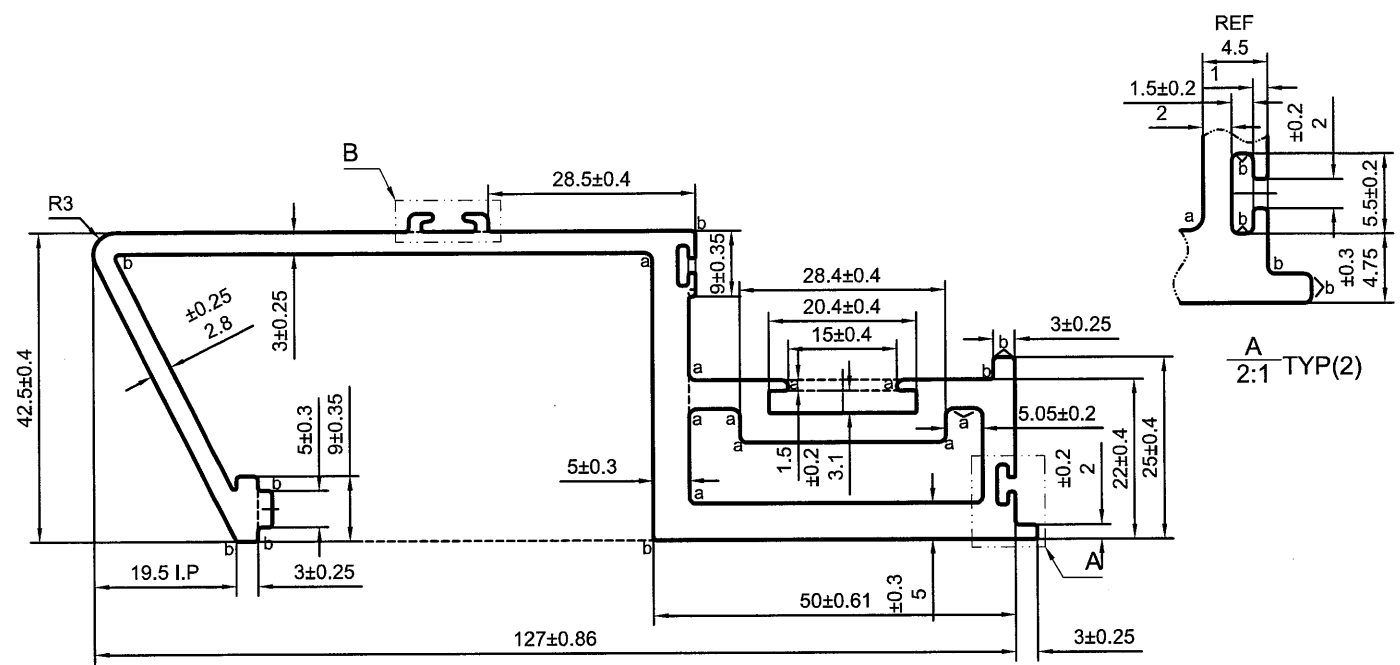

A
2:1 TYP(2)

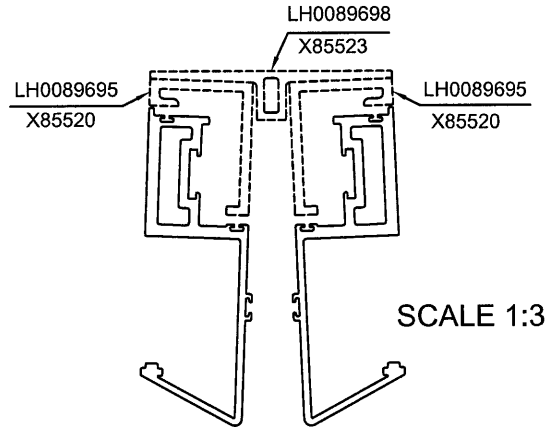
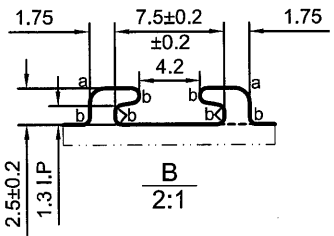

SCALE 1:3

a=R1 b=R0.5

--- 次要装饰面，喷涂膜厚不足，但不露底
 - - - 装饰面
 ●●●●● 凹槽位置可能会有露底现象，即膜厚不足

*配合尺寸以实物配合效果为准！

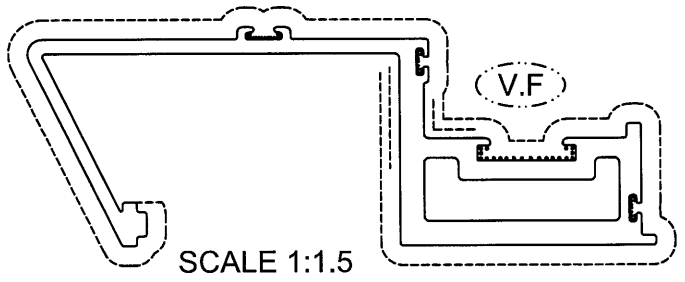

SCALE 1:1.5

SIGNATURE GRADEING	HIGH SIGNATURE GRADEING	C.C.DIA(MM)	Ø135.87						
AREA (SQ MM)	1117.46	UNSPECIFIED THICKNESS	4±0.25	PERIMETER (MM)	498.04	STANDARD	GB 5237.1	SCALE	1:1
MASS (KG/M)	3.028	UNSPECIFIED CORNERS	R 0.5	SURFACE AREA	384.81	ALLOY	6063-T6	VERSION	A
COMPANY ISSUE		A	DRAWA	蔡晓婷	DATE	2018-05-17	APELLATION	-	PAGE OF
			STANDA-RDIZATION		DATE				
			TO SIGN	陈国提	DATE				
			AUDITING		DATE				
MARKER	MODIFY	FILE NO	SIGNATURE	DATE	APPROV	DATE			

PANASIA ALUMINUM (CHINA) LIMITED

CUSTOMER	HONGKONG CO.	CUSTOMER APPROVAL	CUST PART NO.	X85522
			SECTION NO.	LH0089697

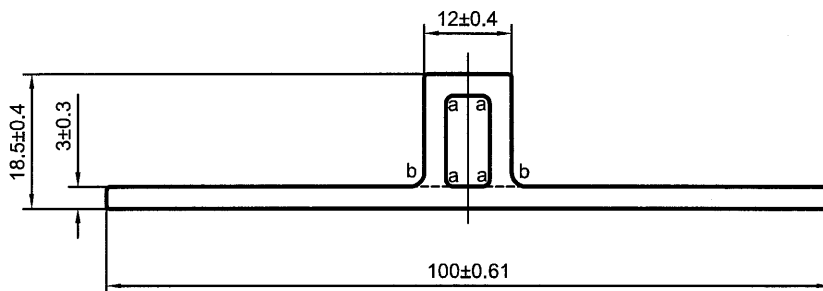

a=R1 b=R2

----- 次要装饰面，喷涂膜厚不足，但不露底
 - - - - - 装饰面



*配合尺寸以实物配合效果为准！

SCALE 1:1.5

(V.F)

SIGNATURE GRADEING	HIGH SIGNATURE GRADEING	C.C.DIA(MM)	Ø100.02		SCALE 1:1.5 (V.F)				
AREA (SQ MM)	413.25	UNSPECIFIED THICKNESS	3±0.25	PERIMETER (MM)	234	STANDARD	GB 5237.1	SCALE	1:1
MASS (KG/M)	1.12	UNSPECIFIED CORNERS	R 0.5	SURFACE AREA	135	ALLOY	6063-T6	VERSION	A
COMPANY ISSUE		A	DRAWN	蔡晓婷	DATE	2018-05-18	APELLATION	-	PAGE OF
			STANDARDIZATION		DATE				
			TO SIGN	陈国提	DATE				
			AUDITING		DATE				
MARKER	MODIFY	FILE NO	SIGNATURE	DATE	APPROV				



CUSTOMER	HONGKONG CO.	CUSTOMER APPROVAL	CUST PART NO.	X85523
			SECTION NO.	LH0089698

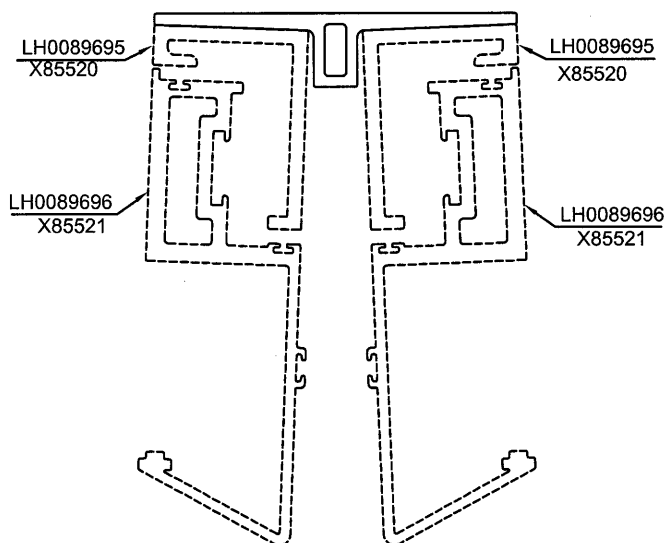
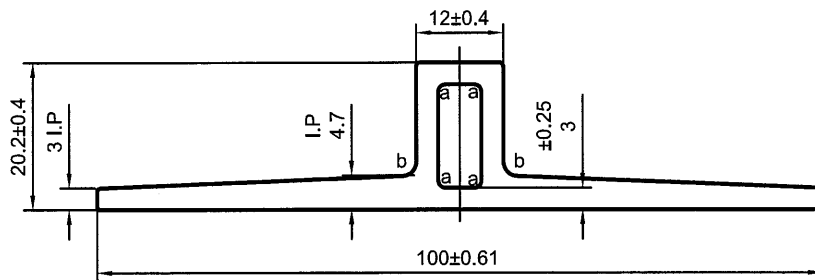

SCALE 1:2

a=R1 b=R2

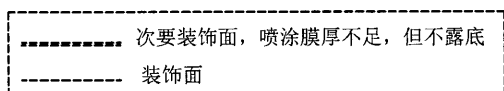

*配合尺寸以实物配合效果为准!

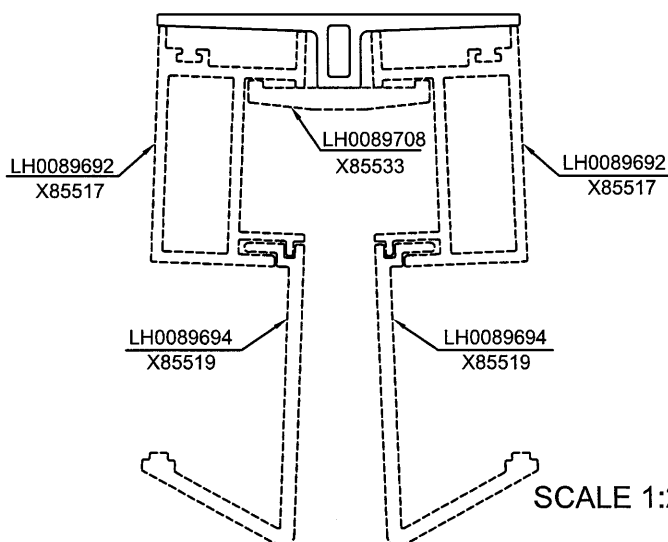

SCALE 1:2

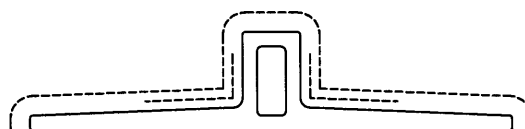

SCALE 1:1.5

(V.F)

SIGNATURE GRADEING	HIGH SIGNATURE GRADEING	C.C.DIA(MM)	Ø100.02						
AREA (SQ MM)	498.42	UNSPECIFIED THICKNESS	3±0.25	PERIMETER (MM)	234.25	STANDARD	GB 5237.1	SCALE	1:1
MASS (KG/M)	1.351	UNSPECIFIED CORNERS	R 0.5	SURFACE AREA	135.25	ALLOY	6063-T6	VERSION	A
COMPANY ISSUE		A	DRAWA	蔡晓婷	DATE	2018-05-18	APELLATION	-	PAGE OF
			STANDARDIZATION		DATE				
			TO SIGN	陈国提	DATE				
			AUDITING		DATE				
MARKER	MODIFY	FILE NO	SIGNATURE	DATE	APPROV				

CUSTOMER	HONGKONG CO.	CUSTOMER APPROVAL		CUST PART NO.	X85524
				SECTION NO.	LH0089699

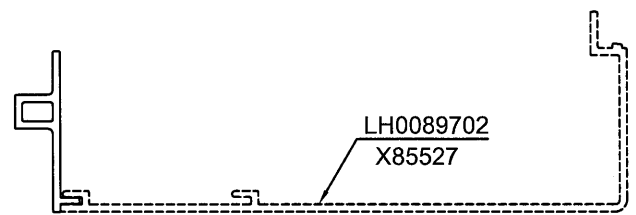
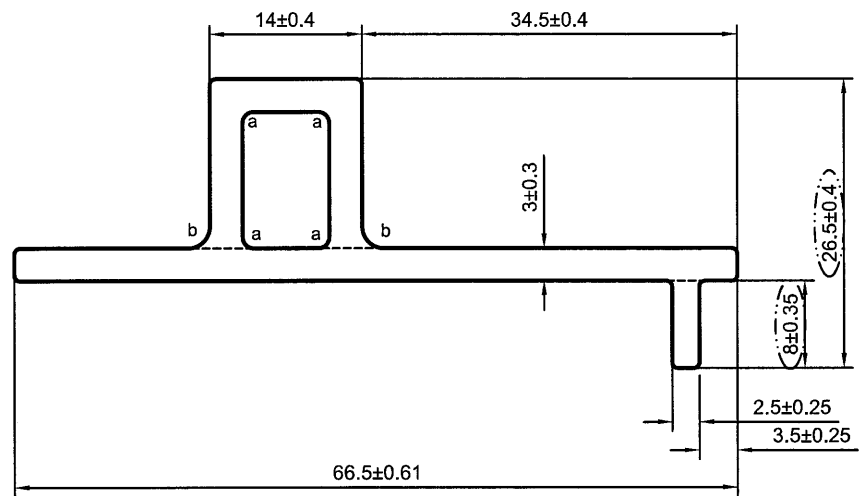

SCALE 1:3

a=R1 b=R2

----- 次要装饰面，喷涂膜厚不足，但不露底
 - - - - - 装饰面

*配合尺寸以实物配合效果为准！

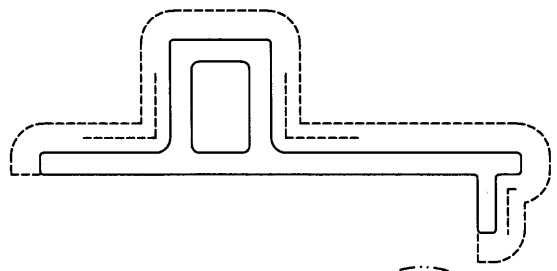

SCALE 1:1

(V.F)

SIGNATURE GRADEING	HIGH SIGNATURE GRADEING	C.C.DIA(MM)	Ø66.53						
AREA (SQ MM)	338.75	UNSPECIFIED THICKNESS	3±0.25	PERIMETER (MM)	182.14	STANDARD	GB 5237.1	SCALE	1.5:1
MASS (KG/M)	0.918	UNSPECIFIED CORNERS	R 0.5	SURFACE AREA	114.85	ALLOY	6063-T6	VERSION	A
COMPANY ISSUE		A	DRAWN	蔡晓婷	DATE	2018-05-24	APELLATION	-	PAGE OF
			STANDARDIZATION		DATE				
			TO SIGN	陈国提	DATE				
			AUDITING		DATE				
MARKER	MODIFY	FILE NO	SIGNATURE	DATE	APPROV	DATE			

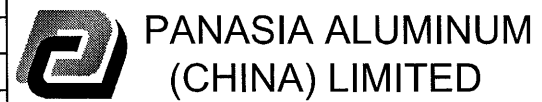

CUSTOMER	HONGKONG CO.	CUSTOMER APPROVAL		CUST PART NO.	X85525
				SECTION NO.	LH0089700

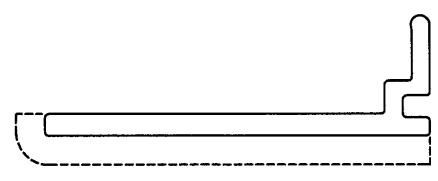
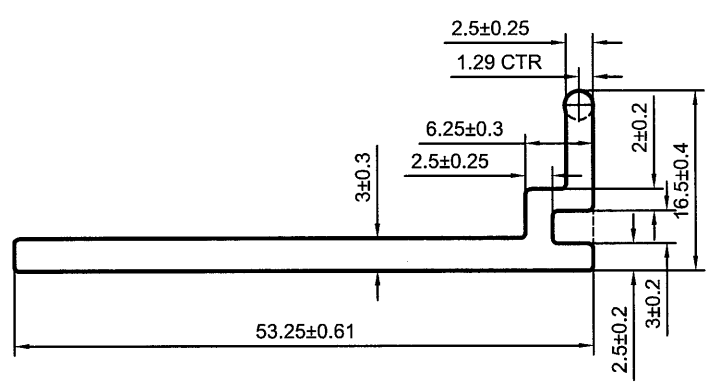

*配合尺寸以实物配合效果为准!

SCALE 1:1 V.F

SIGNATURE GRADEING	HIGH SIGNATURE GRADEING	C.C.DIA(MM)	Ø55.33		SCALE 1:1				V.F	
AREA (SQ MM)	198.5	UNSPECIFIED THICKNESS	-	PERIMETER (MM)	143.88	STANDARD	GB 5237.1	SCALE	1.5:1	
MASS (KG/M)	0.538	UNSPECIFIED CORNERS	R 0.5	SURFACE AREA	56.61	ALLOY	6063-T6	VERSION	A	
COMPANY ISSUE		A	DRAWN	蔡晓婷	DATE	2018-05-18	APPELLATION	-	PAGE OF	
			STANDARDIZATION		DATE					
			TO SIGN	陈国提	DATE					
			AUDITING		DATE					
MARKER	MODIFY FILE NO	SIGNATURE	DATE	APPROV		DATE				



CUSTOMER	HONGKONG CO.	CUSTOMER APPROVAL	CUST PART NO.	X85526
			SECTION NO.	LH0089701

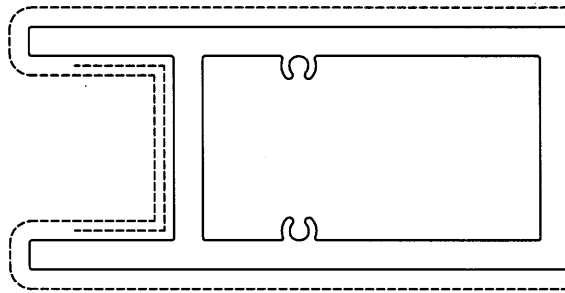
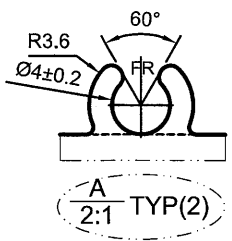
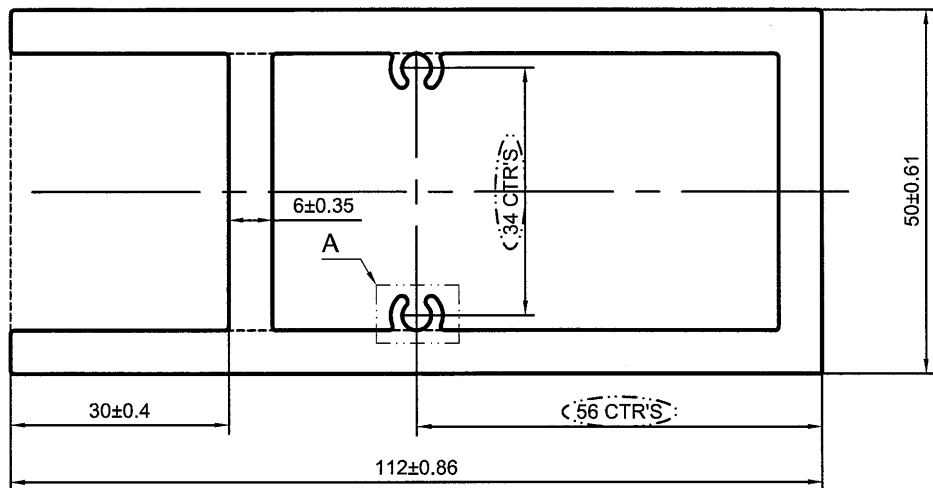

----- 次要装饰面，喷涂膜厚不足，但不露底
 _____ 装饰面

*配合尺寸以实物配合效果为准！

SCALE 1:1.5 V.F

SIGNATURE GRADEING	HIGH SIGNATURE GRADEING	C.C.DIA(MM)	Ø122.33		SCALE 1:1.5 V.F				
AREA (SQ MM)	1832.84	UNSPECIFIED THICKNESS	6±0.3	PERIMETER (MM)	382.28	STANDARD	GB 5237.1	SCALE 1:1	
MASS (KG/M)	4.967	UNSPECIFIED CORNERS	R 0.5	SURFACE AREA	333.28	ALLOY	6063-T5	VERSION B	
COMPANY ISSUE		A	DRAWA	蔡晓婷	DATE	2018-05-30	APELLATION	-	PAGE OF
			STANDA-RDIZATION		DATE				
			TO SIGN	陈国提	DATE				
			AUDITING		DATE				
MARKER	MODIFY	FILE NO	SIGNATURE	DATE	APPROV	DATE			



CUSTOMER	HONGKONG CO.	CUSTOMER APPROVAL	CUST PART NO.	X85527
			SECTION NO.	LH0089702

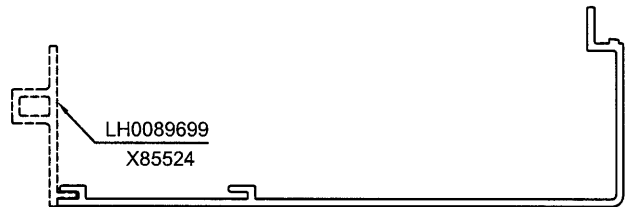
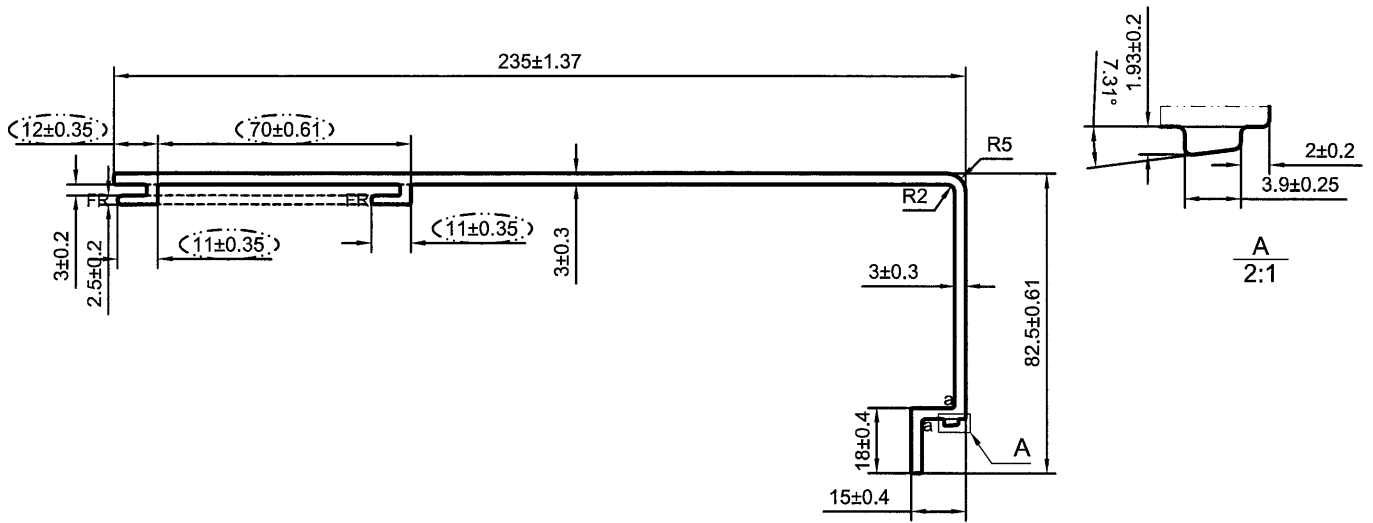

SCALE 1:3

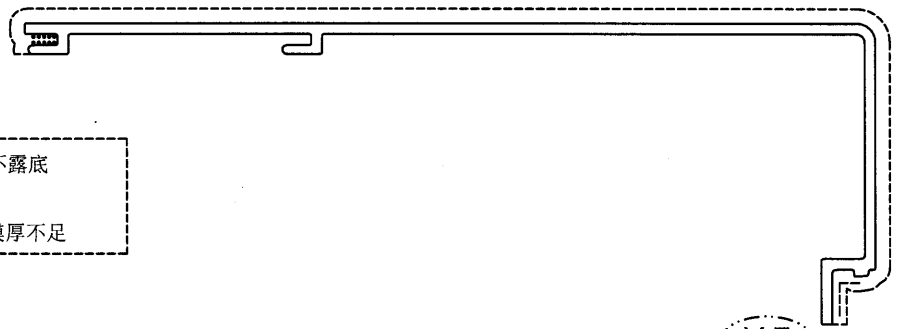

SCALE 1:2

(V.F)

a=R1

- 次要装饰面，喷涂膜厚不足，但不露底
- 装饰面
- 凹槽位置可能会有露底现象，即膜厚不足

*配合尺寸以实物配合效果为准！

SIGNATURE GRADEING	HIGH SIGNATURE GRADEING	C.C.DIA(MM)	Ø244.27						
AREA (SQ MM)	1053.79	UNSPECIFIED THICKNESS	3±0.25	PERIMETER (MM)	706.64	STANDARD	GB 5237.1	SCALE	1:2
MASS (KG/M)	2.856	UNSPECIFIED CORNERS	R 0.5	SURFACE AREA	354.47	ALLOY	6063-T5	VERSION	A
COMPANY ISSUE		A	DRAWN	蔡晓婷	DATE	2018-05-24	APELLATION	-	PAGE OF
			STANDARDIZATION		DATE				
			TO SIGN	陈国提	DATE				
			AUDITING		DATE				
MARKER	MODIFY	FILE NO	SIGNATURE	DATE	APPROV	DATE			



PANASIA ALUMINUM (CHINA) LIMITED

CUSTOMER	HONGKONG CO.	CUSTOMER APPROVAL		CUST PART NO.	X85528
				SECTION NO.	LH0089703

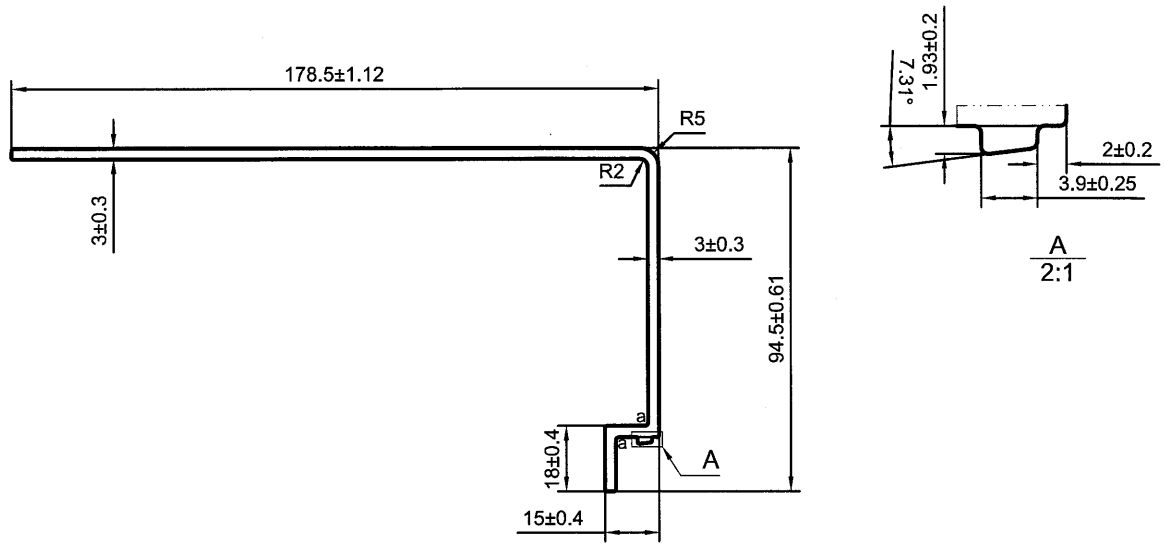

a=R1

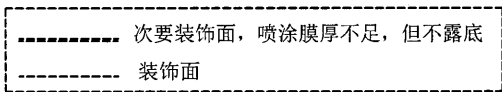

*配合尺寸以实物配合效果为准!

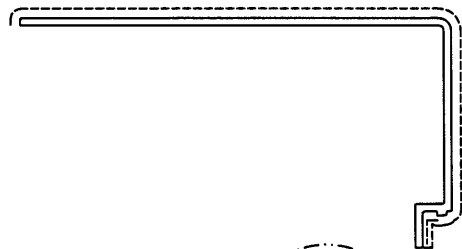

SCALE 1:3

(V.F)

SIGNATURE GRADEING	HIGH SIGNATURE GRADEING	C.C.DIA(MM)	Ø195.08		SCALE 1:3				(V.F)	
AREA (SQ MM)	848.42	UNSPECIFIED THICKNESS	3±0.25	PERIMETER (MM)	567.51	STANDARD	GB 5237.1	SCALE	1:2	
MASS (KG/M)	2.299	UNSPECIFIED CORNERS	R 0.5	SURFACE AREA	288.22	ALLOY	6063-T5	VERSION	A	
COMPANY ISSUE		A	DRAWN	蔡晓婷	DATE	2018-05-23	APPELLATION	-	PAGE OF	
			STANDARDIZATION		DATE					
			TO SIGN	陈国提	DATE					
			AUDITING		DATE					
MARKER	MODIFY	FILE NO	SIGNATURE	DATE	APPROV	DATE				

CUSTOMER	HONGKONG CO.	CUSTOMER APPROVAL		CUST PART NO.	X85529
				SECTION NO.	LH0089704

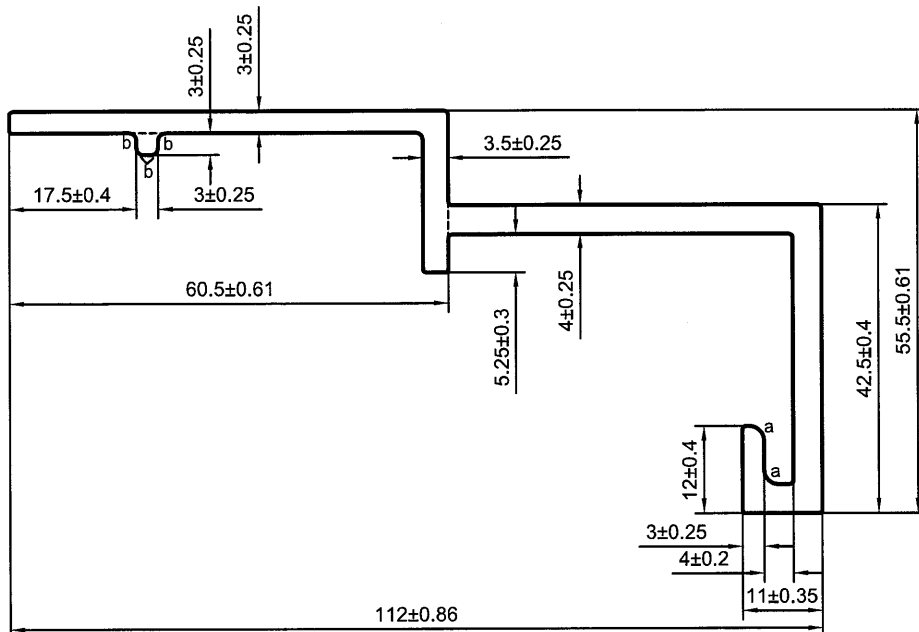

a=R2 b=R1

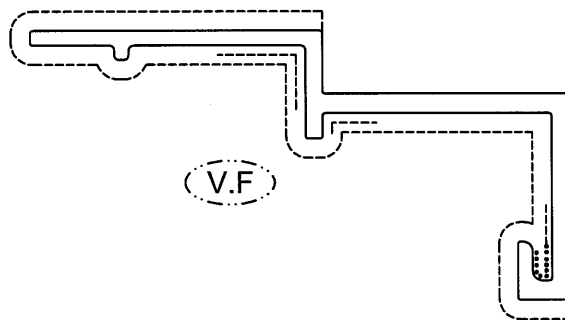
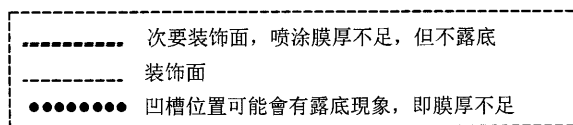

*配合尺寸以实物配合效果为准！

SCALE 1:1.5

SIGNATURE GRADEING	HIGH SIGNATURE GRADEING	C.C.DIA(MM)	Ø 124.66						
AREA (SQ MM)	669.82	UNSPECIFIED THICKNESS	4±0.25	PERIMETER (MM)	374.85	STANDARD	GB 5237.1	SCALE	1:1
MASS (KG/M)	1.815	UNSPECIFIED CORNERS	R 0.5	SURFACE AREA	269.28	ALLOY	6063-T6	VERSION	A
COMPANY ISSUE		A	DRAWN	蔡晓婷	DATE	2018-05-17	APELLATION	-	PAGE OF
			STANDARDIZATION		DATE				
			TO SIGN	陈国提	DATE				
			AUDITING		DATE				
MARKER	MODIFY	FILE NO	SIGNATURE	DATE	APPROV	DATE			



CUSTOMER	HONGKONG CO.	CUSTOMER APPROVAL	CUST PART NO.	X85531
			SECTION NO.	LH0089706

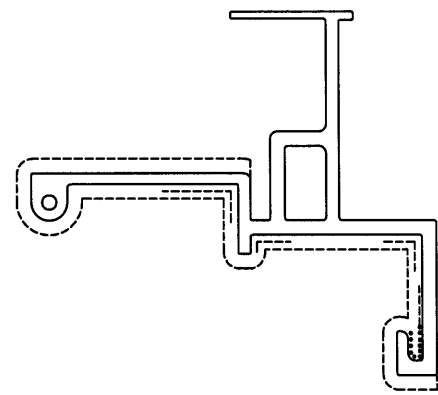
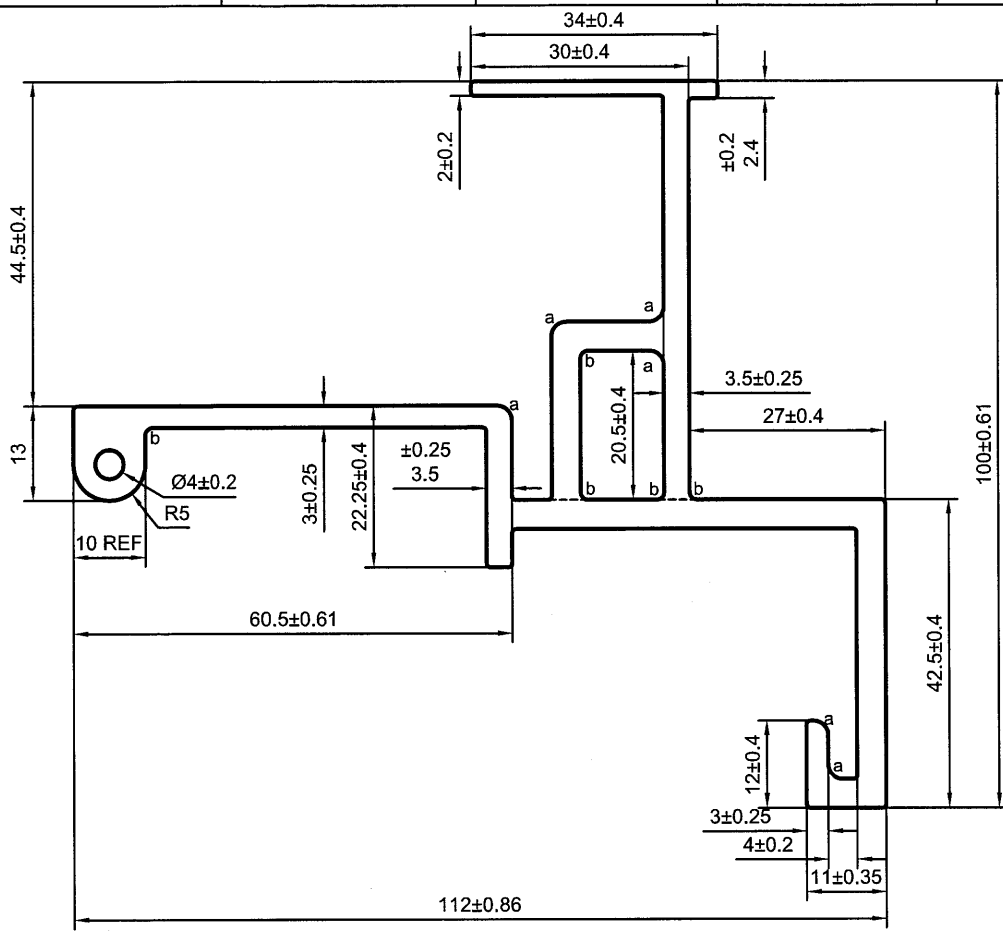

a=R2 b=R1

- 次要装饰面, 喷涂膜厚不足, 但不露底
- 装饰面
- 凹槽位置可能会有露底现象, 即膜厚不足

*配合尺寸以实物配合效果为准!

(V.F)

SCALE 1:2

SIGNATURE GRADEING	HIGH SIGNATURE GRADEING	C.C.DIA(MM)	Ø 128.3						
AREA (SQ MM)	1146.34	UNSPECIFIED THICKNESS	4±0.25	PERIMETER (MM)	557.98	STANDARD	GB 5237.1	SCALE	1:1
MASS (KG/M)	3.107	UNSPECIFIED CORNERS	R 0.5	SURFACE AREA	281.56	ALLOY	6063-T6	VERSION	A
COMPANY ISSUE		A	DRAWA	蔡晓婷	DATE	2018-05-17	APELLATION	-	PAGE OF
			STANDARDIZATION		DATE				
			TO SIGN	陈国提	DATE				
			AUDITING		DATE				
MARKER	MODIFY	FILE NO	SIGNATURE	DATE	APPROV	DATE			



CUSTOMER	HONGKONG CO.	CUSTOMER APPROVAL	CUST PART NO.	X85532
			SECTION NO.	LH0089707

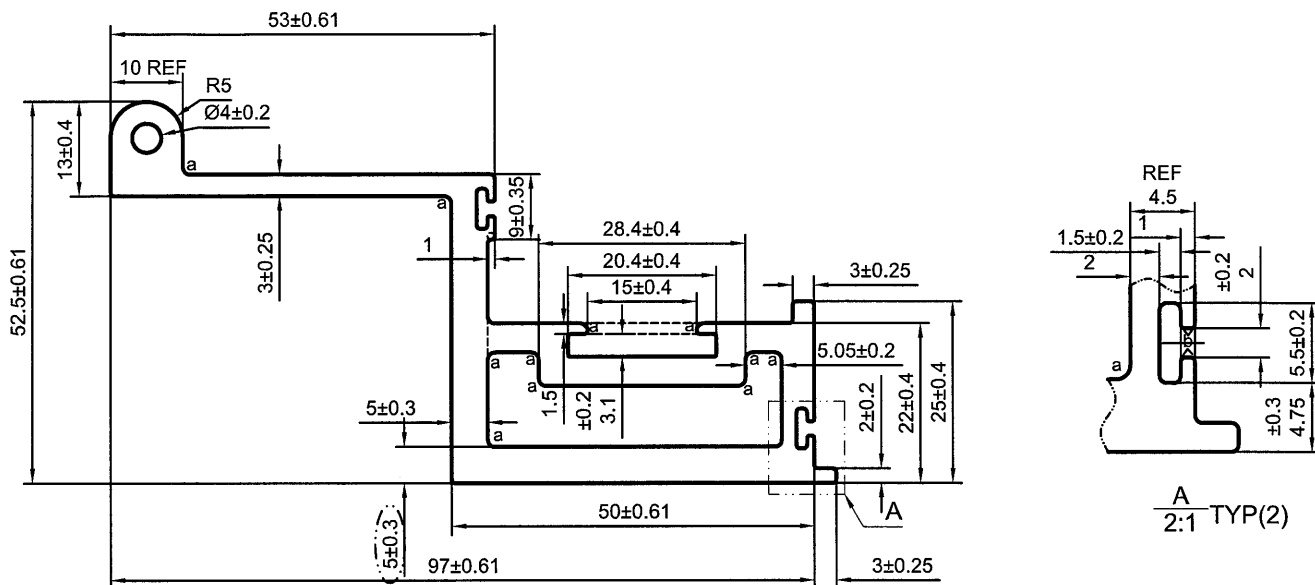

a=R1 b=R0.3

-----	次要装饰面，喷涂膜厚不足，但不露底
-----	装饰面
.....	凹槽位置可能会有露底现象，即膜厚不足

*配合尺寸以实物配合效果为准!

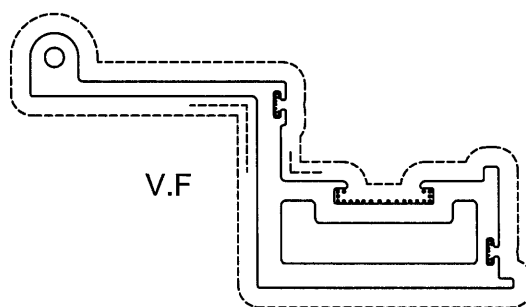

SCALE 1:1.5

SIGNATURE GRADEING	HIGH SIGNATURE GRADEING	C.C.DIA(MM)	Ø 111.04							
AREA (SQ MM)	943.15	UNSPECIFIED THICKNESS	4±0.25	PERIMETER (MM)	344.51	STANDARD	GB 5237.1	SCALE	1:1	
MASS (KG/M)	2.556	UNSPECIFIED CORNERS	R 0.5	SURFACE AREA	344.51	ALLOY	6063-T6	VERSION	B	
COMPANY ISSUE		B	DRAWA	蔡晓婷	DATE	2018-06-25	APELLATION	-	PAGE OF	
			STANDA-RDIZATION		DATE					
			TO SIGN	陈国提	DATE					
			AUDITING		DATE					
MARKER	MODIFY	FILE NO	SIGNATURE	DATE	APPROV					



CUSTOMER	HONGKONG CO.	CUSTOMER APPROVAL	CUST PART NO.	X85533
			SECTION NO.	LH0089708

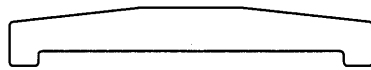
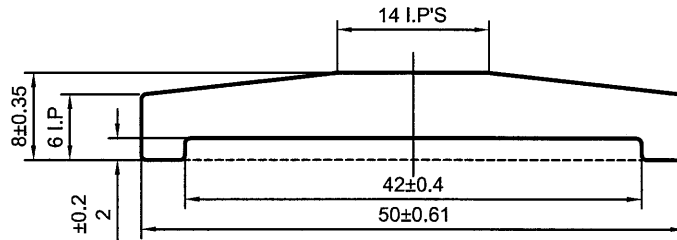

NO V.F SCALE 1:1

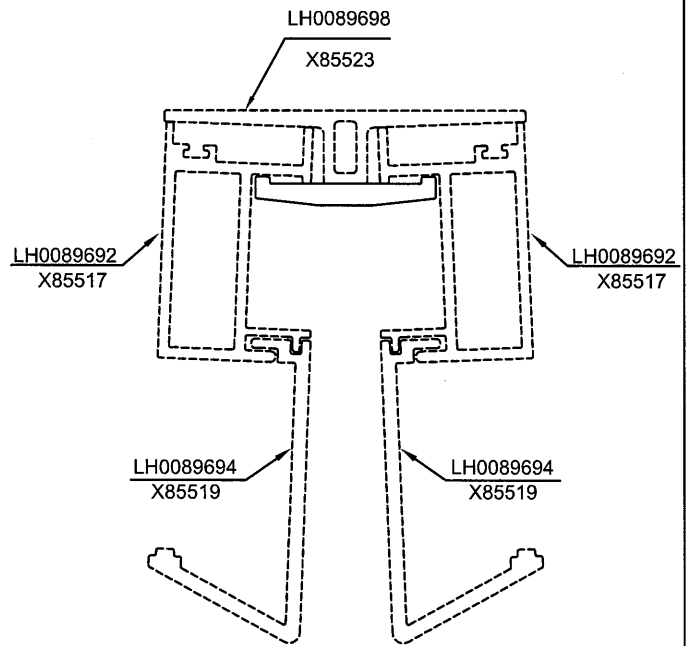

SCALE 1:2

*配合尺寸以实物配合效果为准!

SIGNATURE GRADEING	HIGH SIGNATURE GRADEING	C.C.DIA(MM)	Ø 50.26						
AREA (SQ MM)	279.93	UNSPECIFIED THICKNESS	-	PERIMETER (MM)	114.62	STANDARD	GB 5237.1	SCALE	1.5:1
MASS (KG/M)	0.759	UNSPECIFIED CORNERS	R 0.5	SURFACE AREA	344.51	ALLOY	6063-T6	VERSION	A
COMPANY ISSUE		A	DRAWN	蔡晓婷	DATE	2018-05-18	APPELLATION	-	PAGE OF
			STANDARDIZATION		DATE				
			TO SIGN	陈国提	DATE				
			AUDITING		DATE				
MARKER	MODIFY	FILE NO	SIGNATURE	DATE	APPROV	DATE			



**PANASIA ALUMINUM
(CHINA) LIMITED**

CUSTOMER	HONGKONG CO.	CUSTOMER APPROVAL	CUST PART NO.	X85534
			SECTION NO.	LH0089709

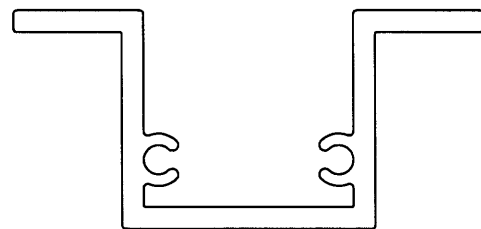
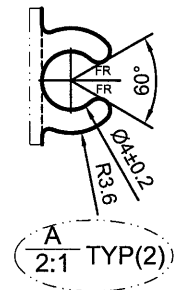
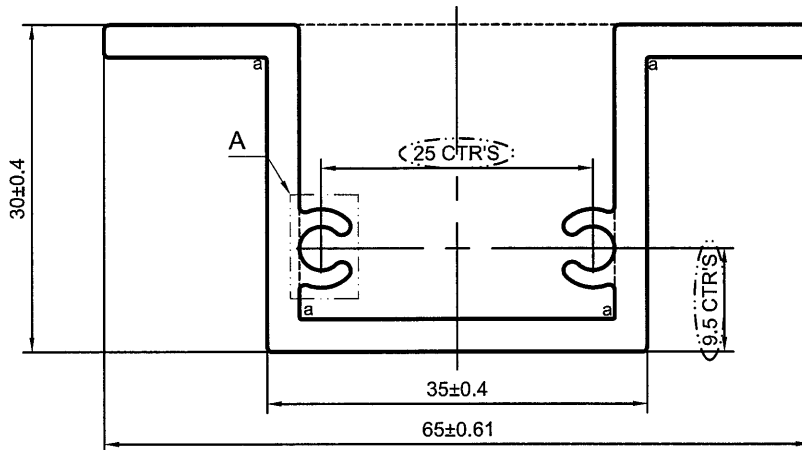

a=R0.2

*配合尺寸以实物配合效果为准!

NO V.F SCALE 1:1

SIGNATURE GRADEING	HIGH SIGNATURE GRADEING	C.C.DIA(MM)	Ø 65.1						
AREA (SQ MM)	389.46	UNSPECIFIED THICKNESS	3±0.25	PERIMETER (MM)	275.55	STANDARD	GB 5237.1	SCALE	1.5:1
MASS (KG/M)	1.055	UNSPECIFIED CORNERS	R 0.5	SURFACE AREA	-	ALLOY	6063-T6	VERSION	B
COMPANY ISSUE		A	DRAWN	蔡晓婷	DATE	2018-05-30	APPELLATION	-	PAGE OF
			STANDARDIZATION		DATE				
			TO SIGN	陈国提	DATE				
			AUDITING		DATE				
MARKER	MODIFY	FILE NO	SIGNATURE	DATE	APPROV	DATE			



CUSTOMER	HONGKONG CO.	CUSTOMER APPROVAL	CUST PART NO.	X85535
			SECTION NO.	LH0089798

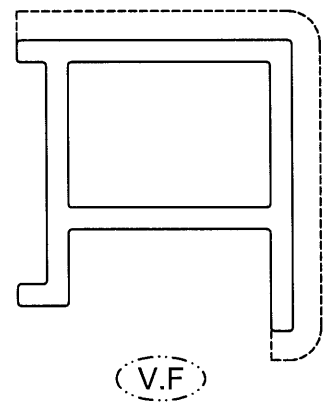
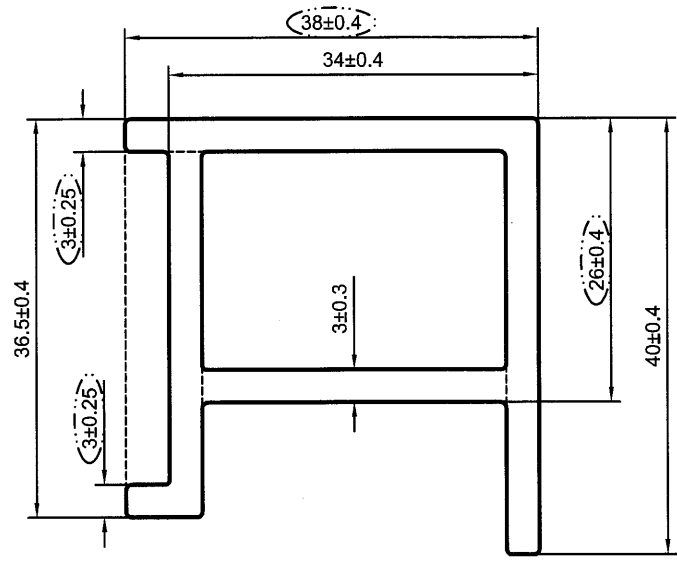

*配合尺寸以实物配合效果为准!

SIGNATURE GRADEING	HIGH SIGNATURE GRADEING	C.C.DIA(MM)	Ø 54.75		SCALE 1:1				
AREA (SQ MM)	421.45	UNSPECIFIED THICKNESS	3±0.25	PERIMETER (MM)	182.4	STANDARD	GB 5237.1	SCALE	1.5:1
MASS (KG/M)	1.142	UNSPECIFIED CORNERS	R 0.5	SURFACE AREA	81.12	ALLOY	6063-T5	VERSION	B
COMPANY ISSUE		A	DRAWA	蔡晓婷	DATE	2018-07-06	APELLATION	-	PAGE OF
			STANDA-RDIZATION		DATE				
			TO SIGN	陈国提	DATE				
			AUDITING		DATE				
MARKER	MODIFY	FILE NO	SIGNATURE	DATE	APPROV				



CUSTOMER	HONGKONG CO.	CUSTOMER APPROVAL	CUST PART NO.	X85537
			SECTION NO.	LH0089800

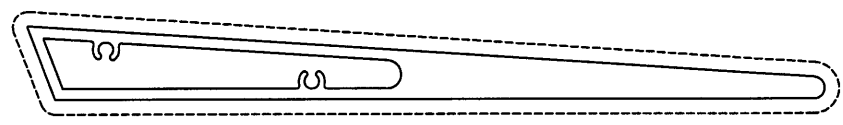
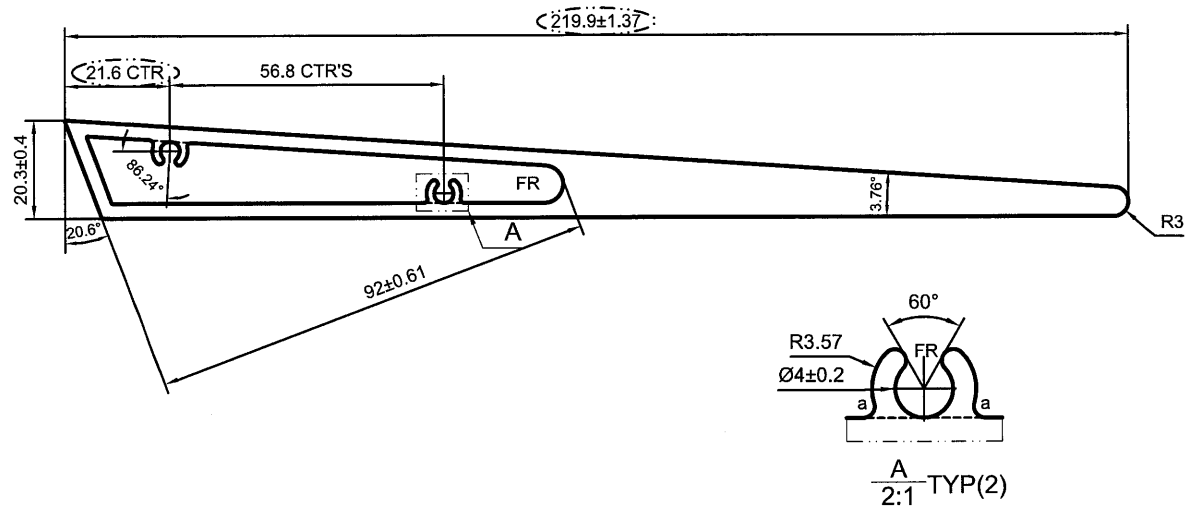

V.F SCALE 1:2

a=R0.8

*配合尺寸以实物配合效果为准!

SIGNATURE GRADEING	HIGH SIGNATURE GRADEING	C.C.DIA(MM)	Ø220.47						
AREA (SQ MM)	1805.39	UNSPECIFIED THICKNESS	3±0.25	PERIMETER (MM)	457.52	STANDARD	GB 5237.1	SCALE	1:1.5
MASS (KG/M)	4.893	UNSPECIFIED CORNERS	R 0.5	SURFACE AREA	457.52	ALLOY	6063-T6	VERSION	B
COMPANY ISSUE		A	DRAWN	蔡晓婷	DATE	2018-07-06	APELLATION	-	PAGE OF
			STANDARDIZATION		DATE				
			TO SIGN	陈国提	DATE				
			AUDITING		DATE				
MARKER	MODIFY	FILE NO	SIGNATURE	DATE	APPROV	DATE			

CUSTOMER	HONGKONG CO.	CUSTOMER APPROVAL	CUST PART NO.	X85538
			SECTION NO.	LH0089832

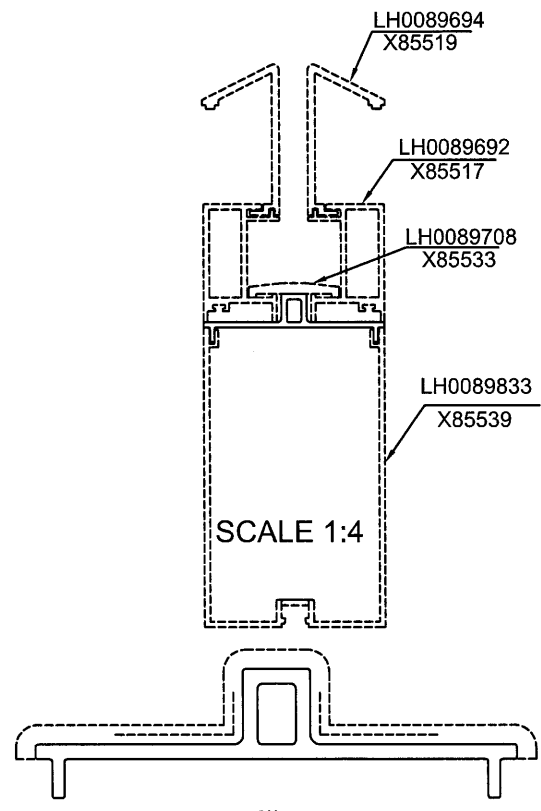
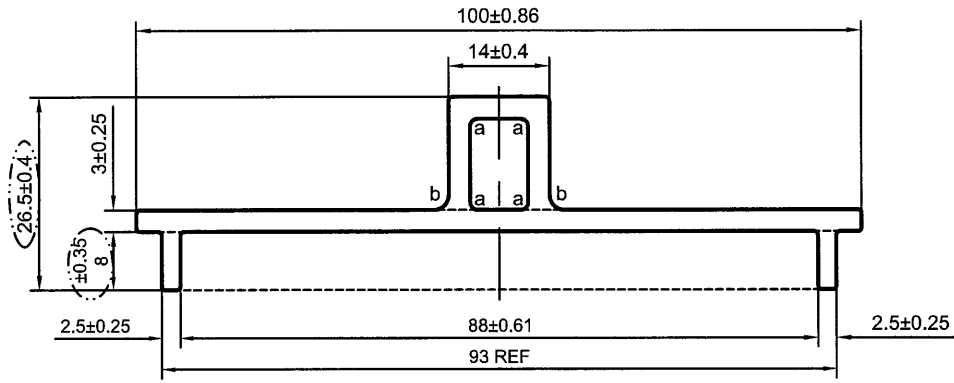

a=R1 b=R2

----- 次要装饰面, 喷涂膜厚不足, 但不露底
 - - - - - 装饰面

*配合尺寸以实物配合效果为准!

(V.F)
 SCALE 1:1.5

SIGNATURE GRADEING	HIGH SIGNATURE GRADEING	C.C.DIA(MM)	Ø100.02						
AREA (SQ MM)	459.25	UNSPECIFIED THICKNESS	3±0.25	PERIMETER (MM)	264.28	STANDARD	GB 5237.1	SCALE	1:1
MASS (KG/M)	1.245	UNSPECIFIED CORNERS	R 0.5	SURFACE AREA	136.2	ALLOY	6063-T6	VERSION	A
COMPANY ISSUE		A	DRAWN	蔡晓婷	DATE	2018-07-16	APELLATION	-	PAGE OF
			STANDARDIZATION		DATE				
			TO SIGN	陈国提	DATE				
			AUDITING		DATE				
MARKER	MODIFY	FILE NO	SIGNATURE	DATE	APPROV				



CUSTOMER	HONGKONG CO.	CUSTOMER APPROVAL		CUST PART NO.	X85539
				SECTION NO.	LH0089833

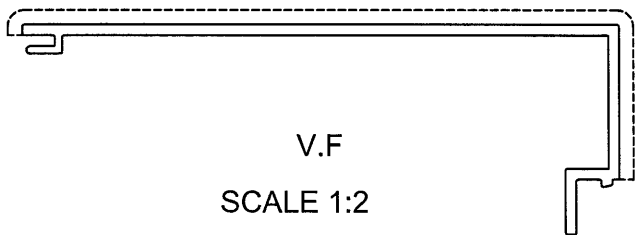
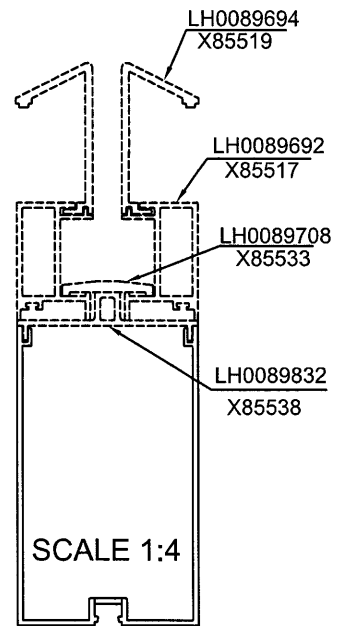
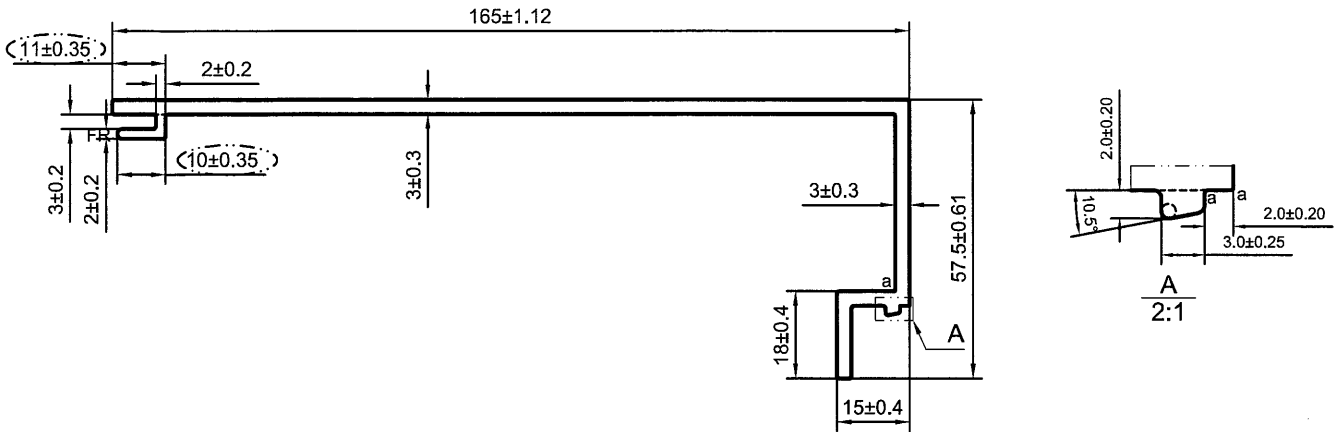

a=R0.2

*配合尺寸以实物配合效果为准!

SIGNATURE GRADEING	HIGH SIGNATURE GRADEING	C.C.DIA(MM)	Ø170.23						
AREA (SQ MM)	725.13	UNSPECIFIED THICKNESS	3±0.25	PERIMETER (MM)	494.32	STANDARD	GB 5237.1	SCALE	1:1.5
MASS (KG/M)	1.965	UNSPECIFIED CORNERS	R 0.5	SURFACE AREA	210.47	ALLOY	6063-T5	VERSION	A
COMPANY ISSUE		A	DRAWA	蔡晓婷	DATE	2018-07-16	APPELLATION	-	PAGE OF
			STANDA-RDIZATION		DATE				
			TO SIGN	陈国提	DATE				
			AUDITING		DATE				
MARKER	MODIFY	FILE NO	SIGNATURE	DATE	APPROV	DATE			