

工程指示 / 要求簡箋(E.I.)

工程指示編號：EI/ 9496 /18

修改版次：B

工程編號：J836

工程名稱：日出康城7期(平台)

工程項目：WW4(A-N) 新增角鐵

收件人：Maggie Lor

發件人：Joe Chan

日期：5/11/2018

□要求提供 / 確認 事項：

- () 初步鋁料 B.M. () 加工拆圖，然後生產 () 尺寸表
 () 正式鋁料 B.M. () 技術上資料 / 指示 () 報價
 () 配件 B.M. () 樣辦或貨品說明書 () 分判合約
 () 其他：_____

內容：

請依附件資料，生產鐵件，完成生產後，按地盤指示送地盤。

請在 20/11/2018 前完成上列要求。

附有關圖紙 / 文件：

43頁

以上項目為：

- 原合約工程包 原合約工程加 / 減賬 新工程報價

原因：-

分發東莞各部門：

- () 生產技術總監 連附件 () 技術部 連附件 () 生產部 連附件 () 機械設計部 連附件
 () 採購部 連附件 () 生產統籌部 連附件
 () 質檢部 連附件 () 會計部 連附件 () 報關組 連附件 () 其他 _____ 連附件

分發香港各部門：

- () 行政部 連附件 () 會計部 連附件 () 統籌部 連附件 () 工程部地盤科文 連附件 積哥
 () 採購部 連附件 () QS 部 連附件 () 維修部 連附件 () 其他 _____ 連附件

傳遞編號：

發件人簽署：

項目經理簽署：

WW4(A-N) 新增鐵件



美特鋁質有限公司
MIDI Aluminium Fabricator Ltd.

工程號:	J-836	計算:		日期:	02/11/2018	送呈:
地盤名稱:	日出康城7期	核對:		日期:	02/11/2018	副本:
項目類別:	幕牆	批准:		日期:		

BM編號:		修改版次:		A/C Code:		鐵件總重量KG:	407.60
-------	--	-------	--	-----------	--	----------	--------

序號	修改內容	鐵件圖號	鐵件名稱	顏色	實用	後備	總數	單位	單件 (kg)	總重量 (kg)	備注
1		2JT-1	50*50*5mm角鐵	熱浸鋅	5	0	5	件	0.145	34.600	
2		3JT-1	75*25*5mm角鐵	熱浸鋅	1	0	1	件	0.435	2.300	
3		3JT-2	75*25*5mm角鐵	熱浸鋅	1	0	1	件	0.152	6.600	
4		3JT-3	75*25*5mm角鐵	熱浸鋅	1	0	1	件	0.154	6.500	
5		3JT-4	75*25*5mm角鐵	熱浸鋅	1	0	1	件	0.156	6.400	
6		3JT-5	75*25*5mm角鐵	熱浸鋅	1	0	1	件	0.154	6.500	
7		3JT-6	75*25*5mm角鐵	熱浸鋅	1	0	1	件	0.156	6.400	
8		3JT-7	75*25*5mm角鐵	熱浸鋅	1	0	1	件	0.164	6.100	
9		3JT-8	75*25*5mm角鐵	熱浸鋅	1	0	1	件	0.161	6.200	
10		3JT-9	75*25*5mm角鐵	熱浸鋅	1	0	1	件	0.154	6.500	
11		3JT-10	100*50*6mm角鐵	熱浸鋅	1	0	1	件	0.333	3.000	
12		3JT-11	100*50*6mm角鐵	熱浸鋅	1	0	1	件	0.111	9.000	
13		3JT-12	100*50*6mm角鐵	熱浸鋅	1	0	1	件	0.102	9.800	
14		3JT-13	100*50*6mm角鐵	熱浸鋅	7	0	7	件	0.086	81.500	
15		3JT-14	100*50*6mm角鐵	熱浸鋅	2	0	2	件	0.092	21.700	
16		3JT-15	100*50*6mm角鐵	熱浸鋅	1	0	1	件	0.086	11.600	
17		3JT-16	100*50*6mm角鐵	熱浸鋅	1	0	1	件	0.087	11.500	
18		3JT-17	100*50*6mm角鐵	熱浸鋅	1	0	1	件	0.088	11.400	
19		3JT-18	100*50*6mm角鐵	熱浸鋅	1	0	1	件	0.086	11.600	



美特鋁質有限公司
MDI Aluminium Fabricator Ltd.

工程號:

J-836

計算:

日期:

02/11/2018

送呈:

地盤名稱:

日出康城7期

核對:

日期:

02/11/2018

副本:

地盤鐵件BM表

項目類別:

幕牆

批准:

日期:

BM編號:

修改版次:

A/C Code:

鐵件總重量KG: 407.60

序號	修改內容	鐵件圖號	鐵件名稱	顏色	實用	後備	總數	單位	單件 (kg)	總重量 (kg)	備注
20		4JT-1	100*50*6mm角鐵	熱浸鋅	1	0	1	件	0.125	8.000	
21		4JT-2	100*50*6mm角鐵	熱浸鋅	2	0	2	件	7.300	14.600	
22		4JT-3	100*50*6mm角鐵	熱浸鋅	1	0	1	件	0.105	9.500	
23		4JT-4	100*50*6mm角鐵	熱浸鋅	1	0	1	件	0.114	8.800	
24		4JT-5	100*50*6mm角鐵	熱浸鋅	1	0	1	件	0.086	11.600	
25		4JT-6	100*50*6mm角鐵	熱浸鋅	1	0	1	件	0.088	11.400	
26		4JT-7	100*50*6mm角鐵	熱浸鋅	1	0	1	件	0.087	11.500	
27		4JT-8	100*50*6mm角鐵	熱浸鋅	1	0	1	件	0.092	10.900	
28		4JT-9	100*50*6mm角鐵	熱浸鋅	1	0	1	件	0.098	10.200	
29		4JT-10	100*50*6mm角鐵	熱浸鋅	3	0	3	件	0.094	31.900	
30		4JT-11	100*50*6mm角鐵	熱浸鋅	1	0	1	件	0.164	6.100	
31		4JT-12	100*50*6mm角鐵	熱浸鋅	1	0	1	件	0.175	5.700	
32		4JT-13	100*50*6mm角鐵	熱浸鋅	1	0	1	件	0.182	5.500	
33		4JT-14	100*50*6mm角鐵	熱浸鋅	1	0	1	件	0.370	2.700	
					合計:		47	件	合計:	407.600	

2

3

WW4 -A-N新增角铁-构件清单- MT

Assembly Mark	No.	NAME	Profile	Area(m ²) for all	Weight(kg) for all
2JT-1	5	BEAM	RSA50*50*5	1.73	34.60
3JT-1	1	BEAM	RSA75*25*5	0.13	2.30
3JT-2	1	BEAM	RSA75*25*5	0.36	6.60
3JT-3	1	BEAM	RSA75*25*5	0.35	6.50
3JT-4	1	BEAM	RSA75*25*5	0.35	6.40
3JT-5	1	BEAM	RSA75*25*5	0.35	6.50
3JT-6	1	BEAM	RSA75*25*5	0.34	6.40
3JT-7	1	BEAM	RSA75*25*5	0.33	6.10
3JT-8	1	BEAM	RSA75*25*5	0.33	6.20
3JT-9	1	BEAM	RSA75*25*5	0.35	6.50
3JT-10	1	BEAM	RSA100*50*6	0.11	3.00
3JT-11	1	BEAM	RSA100*50*6	0.32	9.00
3JT-12	1	BEAM	RSA100*50*6	0.34	9.80
3JT-13	7	BEAM	RSA100*50*6	2.87	81.50
3JT-14	2	BEAM	RSA100*50*6	0.76	21.70
3JT-15	1	BEAM	RSA100*50*6	0.41	11.60
3JT-16	1	BEAM	RSA100*50*6	0.41	11.50
3JT-17	1	BEAM	RSA100*50*6	0.40	11.40
3JT-18	1	BEAM	RSA100*50*6	0.41	11.60
4JT-1	1	BEAM	RSA100*50*6	0.35	8.00
4JT-2	1	BEAM	RSA100*50*6	0.32	7.30
4JT-2	1	BEAM	RSA100*50*6	0.32	7.30
4JT-3	1	BEAM	RSA100*50*6	0.42	9.50
4JT-4	1	BEAM	RSA100*50*6	0.39	8.80
4JT-5	1	BEAM	RSA100*50*6	0.51	11.60
4JT-6	1	BEAM	RSA100*50*6	0.51	11.40
4JT-7	1	BEAM	RSA100*50*6	0.51	11.50
4JT-8	1	BEAM	RSA100*50*6	0.48	10.90
4JT-9	1	BEAM	RSA100*50*6	0.45	10.20
4JT-10	3	BEAM	RSA100*50*6	1.42	31.90
4JT-11	1	BEAM	RSA100*50*6	0.27	6.10
4JT-12	1	BEAM	RSA100*50*6	0.25	5.70
4JT-13	1	BEAM	RSA100*50*6	0.24	5.50
4JT-14	1	BEAM	RSA100*50*6	0.12	2.70
Total for	47	assemblies:		17.24	407.75

4

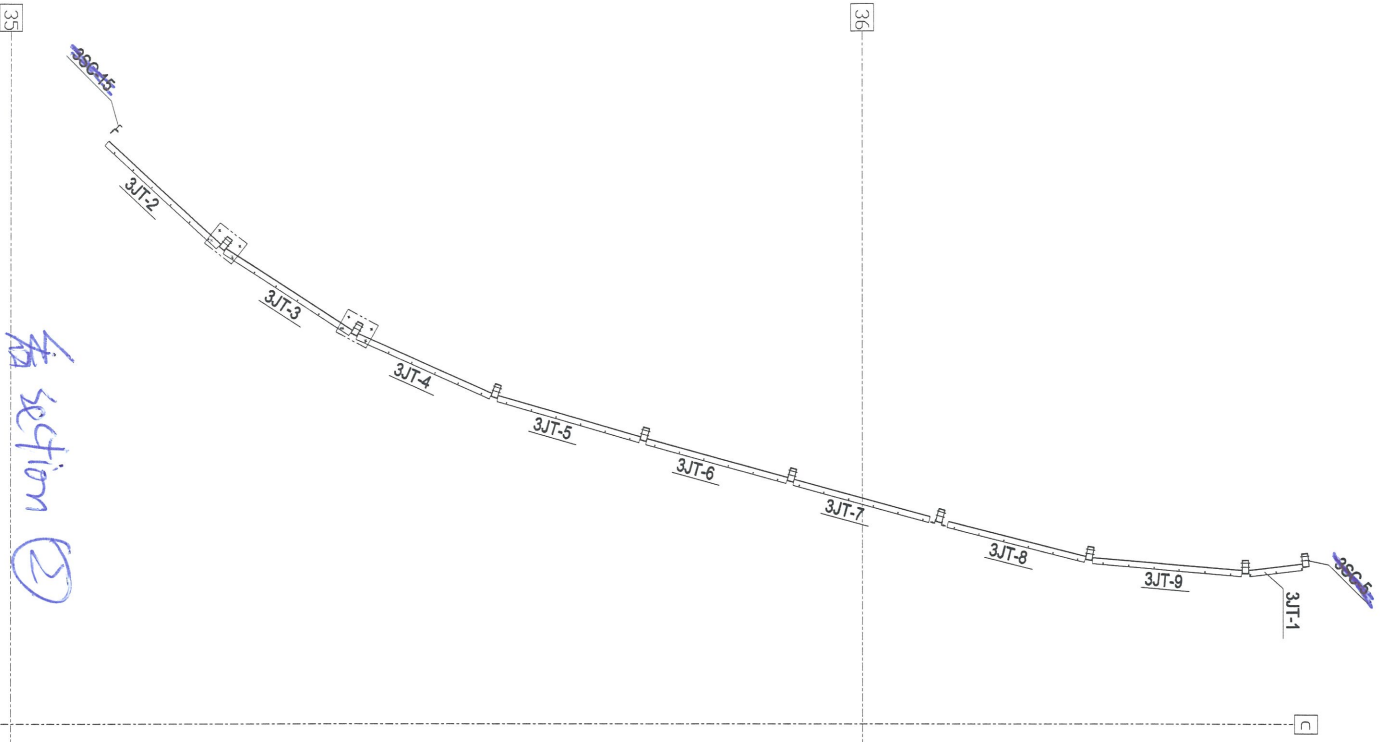

看 section ②

PART PLAN FOR WW4 A-N @ 3/F

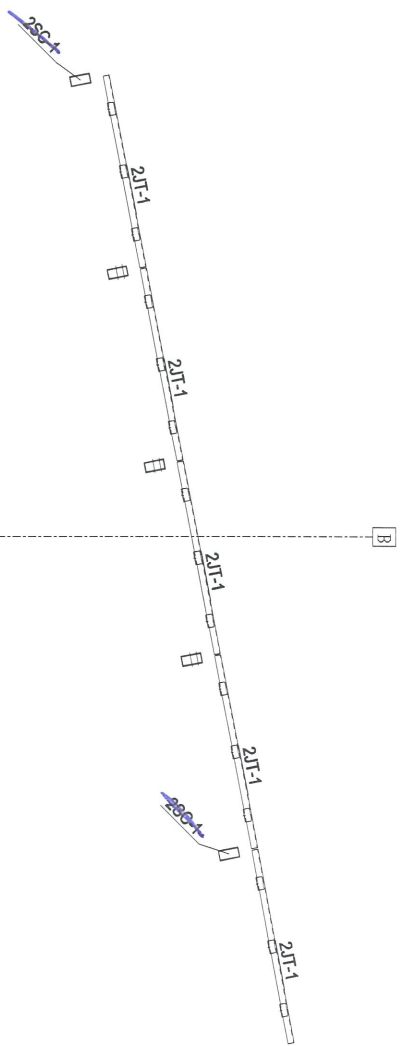

看 section ①

PART PLAN FOR WW4 A-N @ 2/F

Rev.	Description	Date
0	第一次报批	2018-11-02

PROJECT:
 PROPOSED SITE C1
 DEVELOPMENT AT AREA 85,
 TKO TL 20/RP TSEUNG KWAN O,
 NEW TERRITORIES

CLIENT:
 **美特銀質有限公司**
 MIDII Advanced Architecture Ltd.
 Units 5-8, Sunray Industrial Centre, 1/F
 610 Chee Kwo Ling Road, Kowloon
 Tel: 23489211-4 Fax: (852) 27121556

 **銀同有限公司**
 Silver Town Limited
 Tel: 0769-83354988 Fax: 0769-83359954
 E-Mail: ADMIN@silvertown.com.hk

DRAWING TITLE:
 新增角铁布置图
 @WW4-A-N-2/F-3/F

CAD File Name :	
Designed by	
Drawn by	
Reviewed by	
Approved by	
Scale	
DWG NO. : WW4-AN-JT-MP01	REV. 0

5

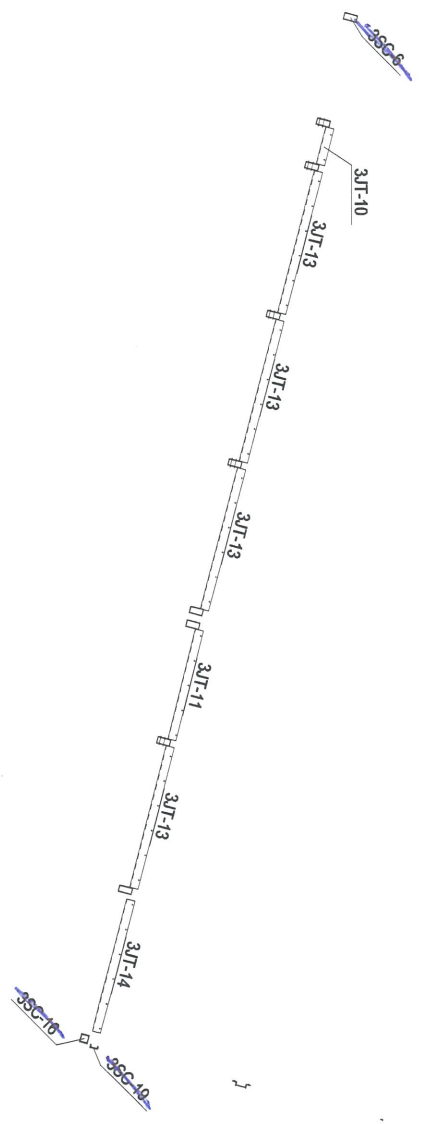

看 Section B

PART PLAN FOR WW4 A-N @ 3/F

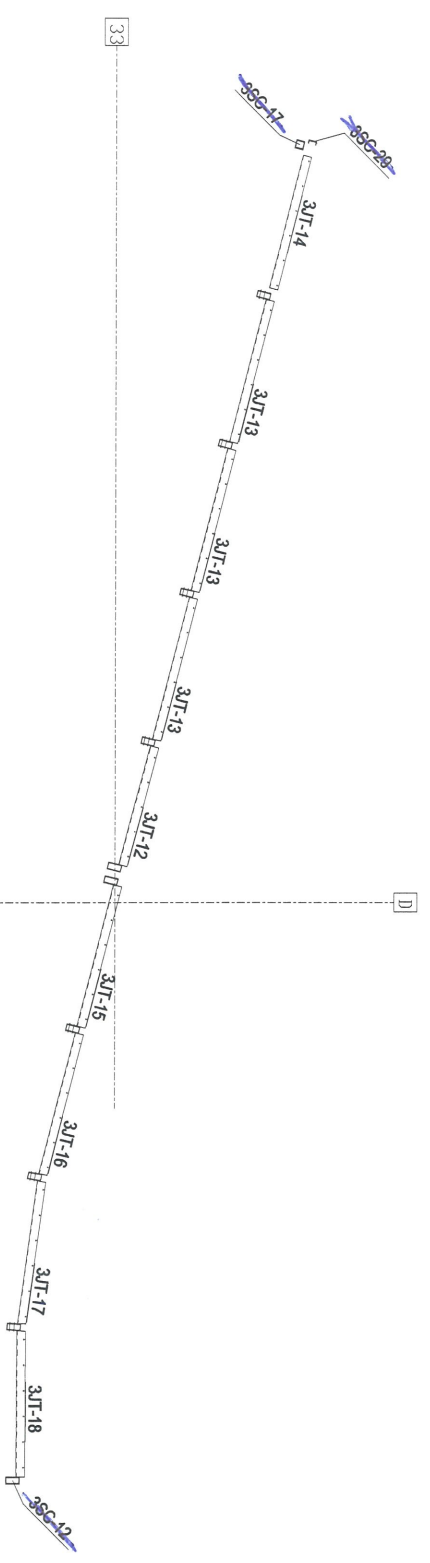

PART PLAN FOR WW4 A-N @ 3/F

Rev	Description	Date
0	第一次报批	2018-11-02

PROJECT:
 PROPOSED SITE C1
 DEVELOPMENT AT AREA 88,
 TKOIL TO RP, TSEUNG KWAN O,
 NEW TERRITORIES

CLIENT:
美特铝有限公司
 MTDI ALUMINIUM FABRICATOR LTD.
 Units 5-8, Sunny Industrial Centre, 1/F
 610 Chee Koo Lung Road, Kowloon
 Tel: 23489211-4 Fax: (852) 2727056

DESIGNED BY:
银同有限公司
 Silver Town Limited
 Tel: 0769-83354988 Fax: 0769-8335954
 E-MAIL: ADDRESS: silvertown@163.COM

DRAWING TITLE:
 新增角铁布置图
 @WW4-A-N-3/F

CAO File Name :	
Designed by	
Drawn by	
Reviewed by	
Approved by	
Scale	
DWG NO. : WW4-A-N-JT-MP02	REV. 0

6

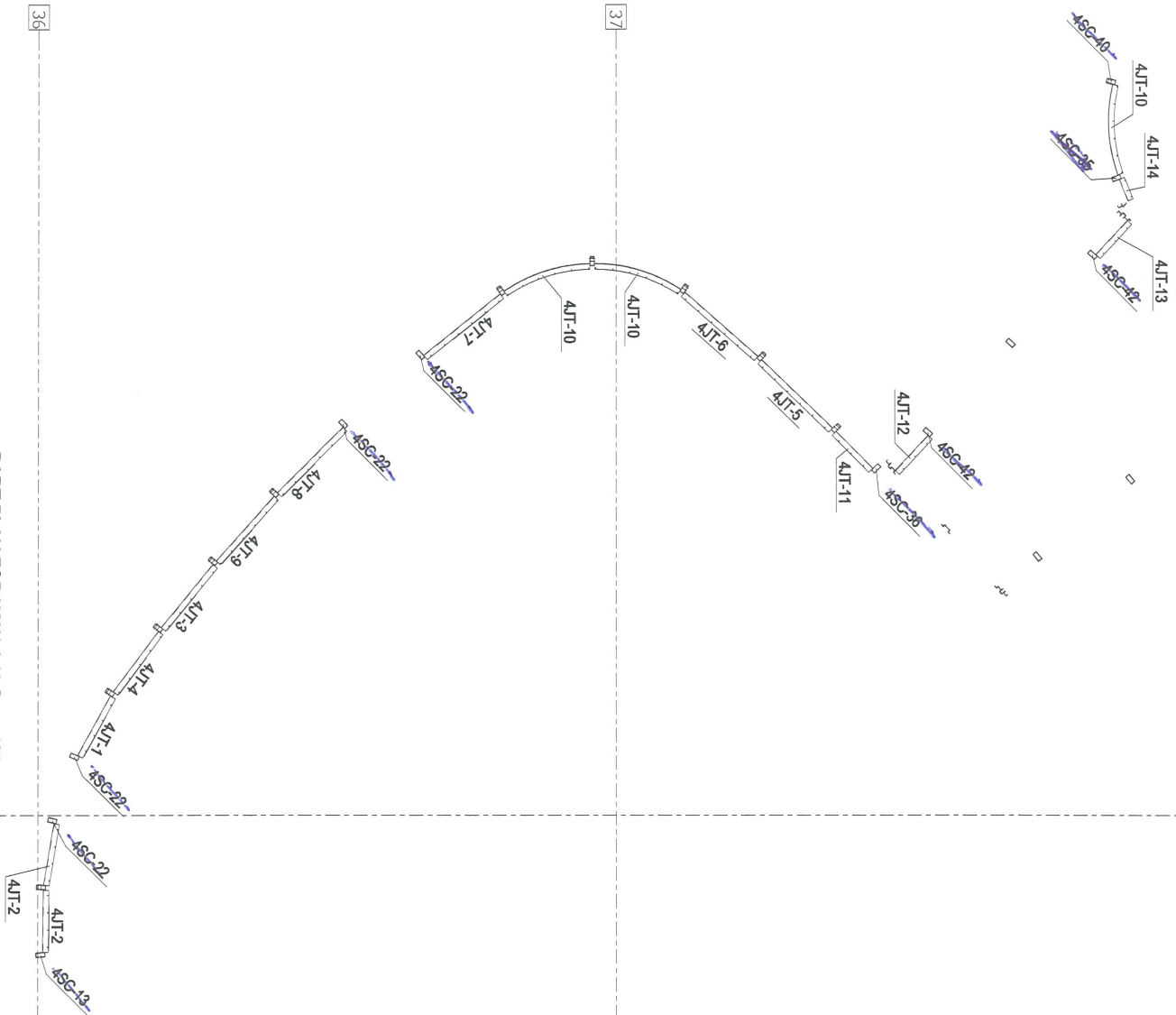

PART PLAN FOR WW4 A-N @ 4/F

Section 4

Rev	Description	Date
0	第一次报批	2018-11-02

PROJECT:
 PROPOSED SITE C1
 DEVELOPMENT AT AREA 86,
 TKOHL 70 RP, TSEUNG KWAN O,
 NEW TERRITORIES

CLIENT:
 **美特铝业有限公司**
 MTDI ALUMINIUM FABRICATOR LTD.
 Units 6-8, Sunny Industrial Centre, 1/F
 610 Chee Kwo Ling Road, Kowloon
 Tel: 23489211-4 Fax: (852) 2727656

 **银同有限公司**
 Silver Town Limited
 Tel: 0769-8339498 Fax: 0769-8339954
 E-mail: AD008554@skdw.com.hk; 163.COM

DRAWING TITLE:
 新增角铁布置图
 @WW4-A-N-4/F

CAO File Name:	
Designed by	
Drawn by	
Reviewed by	
Approved by	
Scale	
DWG NO.: WW4-AN-JT-MP03	REV: 0

Section 1

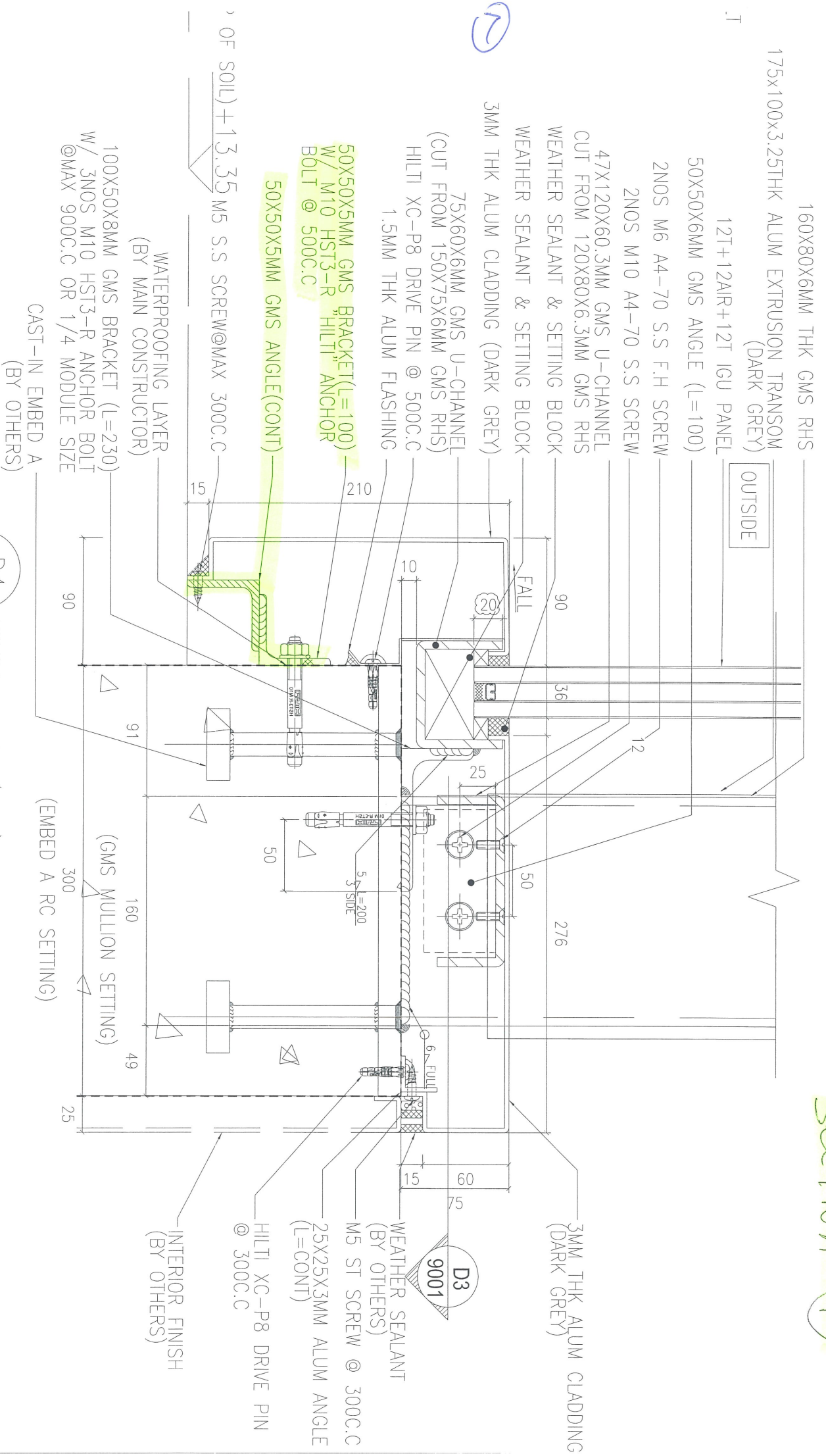

D4 WINDOW-WALL (WW4) TYPICAL DETAIL
 9001

Section 3

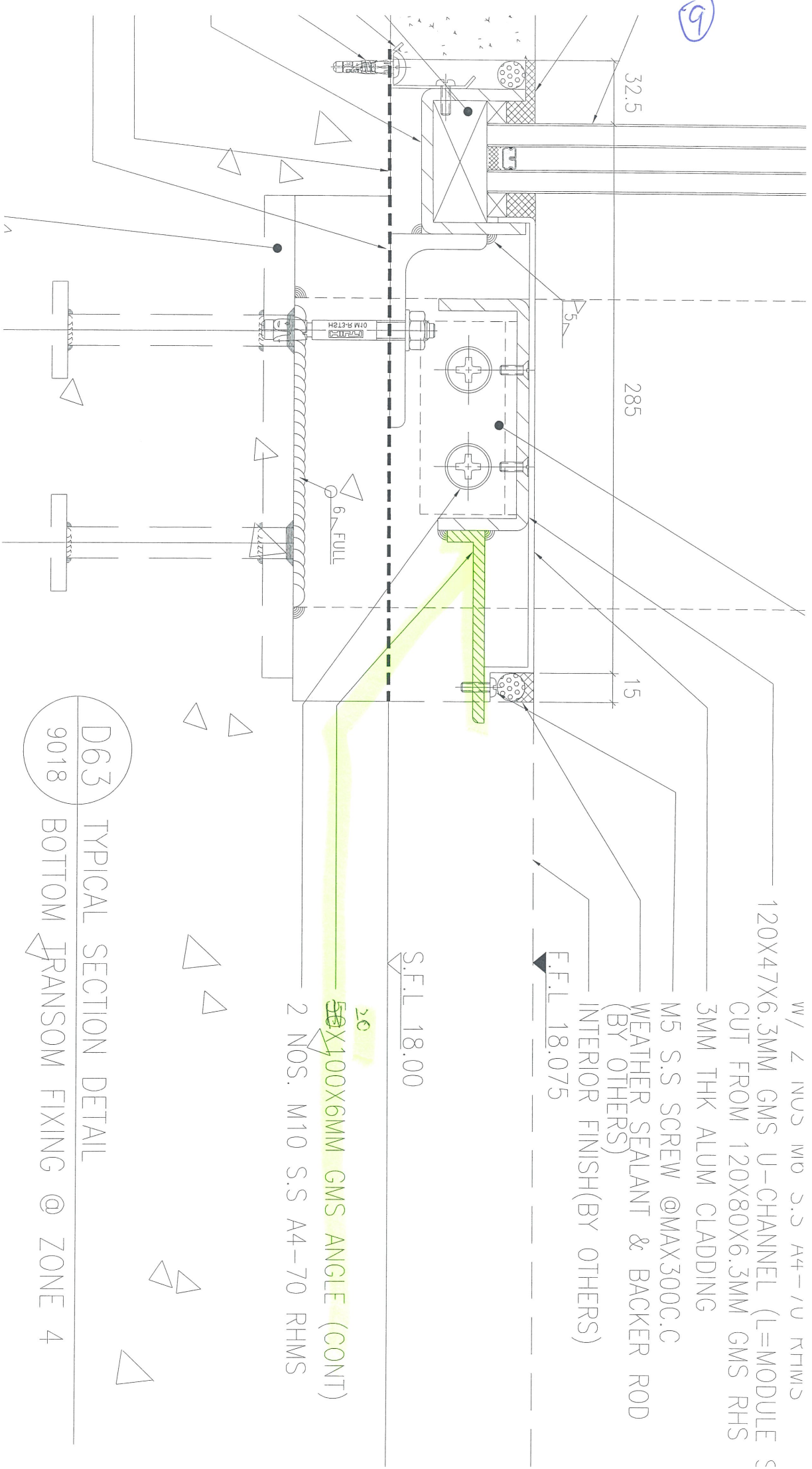

W / 2 NOS M5 S.S A4-70 RHMS
 120X47X6.3MM GMS U-CHANNEL (L=MODULE S
 CUT FROM 120X80X6.3MM GMS RHS
 3MM THK ALUM CLADDING

M5 S.S SCREW @MAX300C.C
 WEATHER SEALANT & BACKER ROD
 (BY OTHERS)
 INTERIOR FINISH(BY OTHERS)

F.F.L 18.075

S.F.L 18.00

20
 50X100X6MM GMS ANGLE (CONT)
 2 NOS. M10 S.S A4-70 RHMS

D63 TYPICAL SECTION DETAIL
 9018 BOTTOM TRANSOM FIXING @ ZONE 4

10

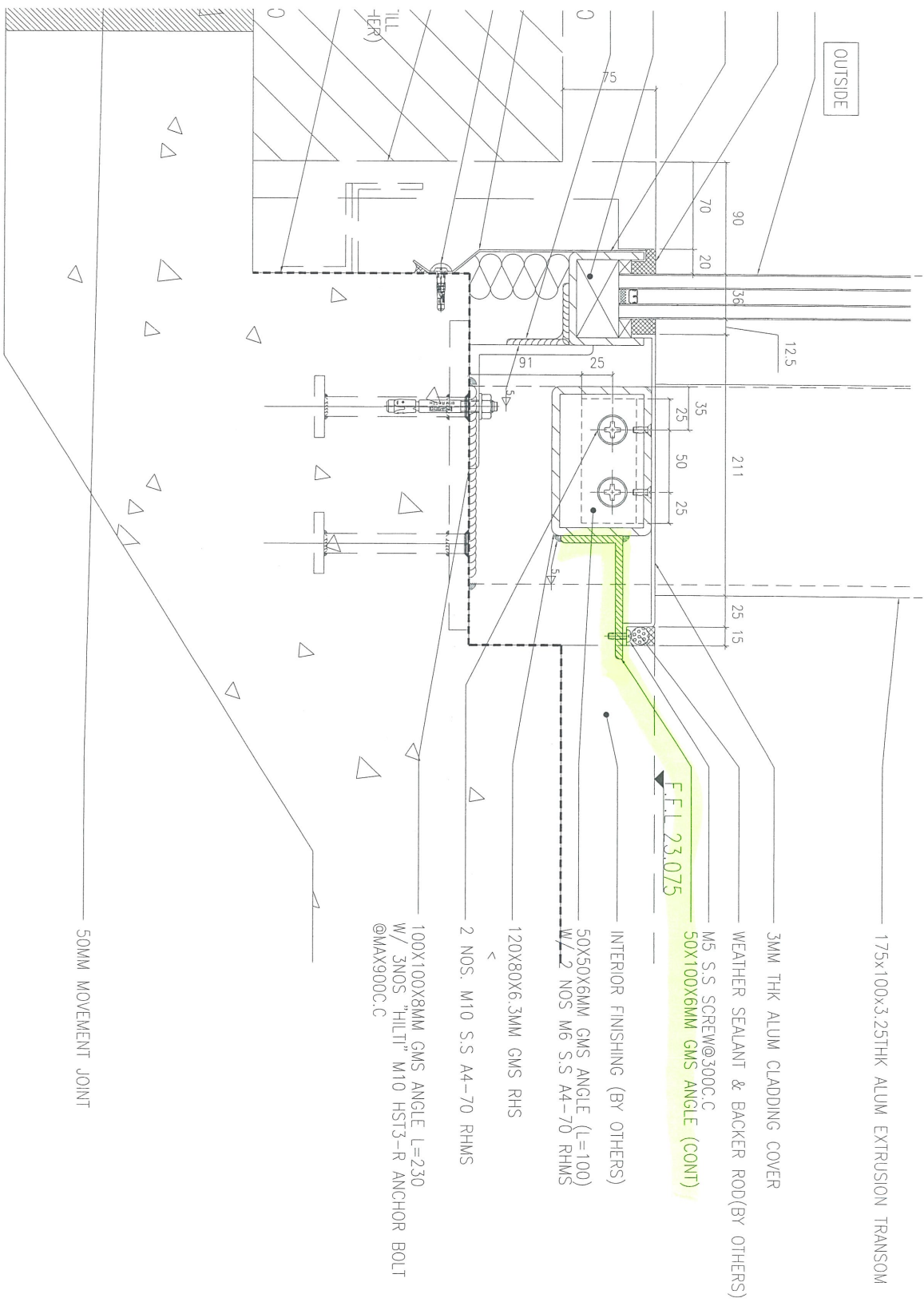

D27 WINDOW-WALL (WW4) TYPICAL DETAIL
9007

Section 4

散件出

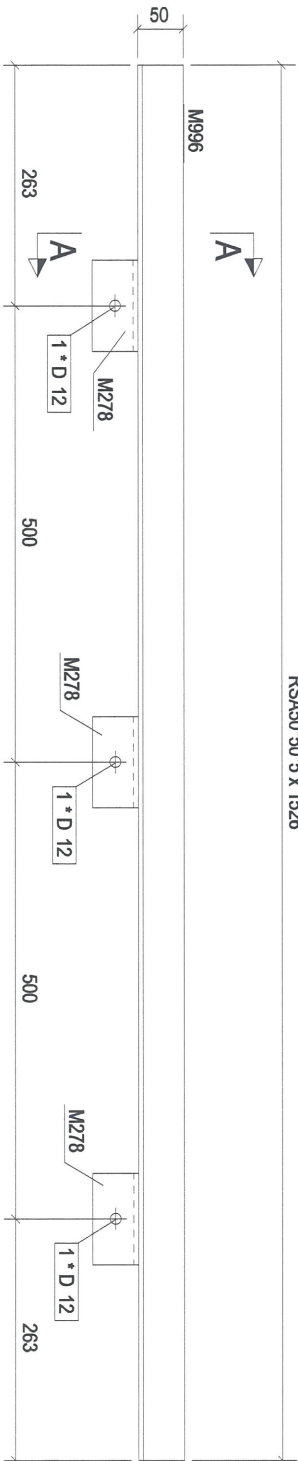

RSAS0*50*5 x 1526

构件: 2JT-1

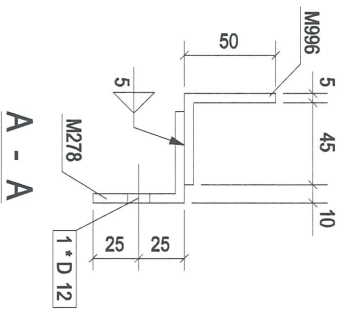

构件编号:	2JT-1	构件数量:	5	构件重量:	6.92	
部件编号	规格(mm)	长度(mm)	数量	单重(kg)	共重(kg)	表面积(m ²)
M278	RSAS0*50*5	100	3	0.38	1.14	0.02
M996	RSAS0*50*5	1526	1	5.79	5.79	0.29
合计:				6.92		

Rev	Description	Date
0	第一次报批	2018-11-02

PROJECT: PROPOSED SITE C1
DEVELOPMENT AT AREA 06,
TR01, 70 RP, TSEING KWAN O,
NEW TERRITORIES

CLIENT: 美特铝业有限公司
MIDD Aluminium Fabricators Ltd.
Unit 6, 8, Sunray Industrial Centre, 1/F
610 Cheung Yee Long Road, Tseung Kwan O,
Tsing Yi, New Territories
Tel: 23892111 Fax: (852) 27272666

Silver Town Limited
140769-83359468 Fax: 018-8335954
E-mail: address@silvertown.hk, tsx.com

DRAWING TITLE :
[2JT-1]

CAD File Name :	
Designed by	
Drawn by	
Reviewed by	
Approved by	
Scale	
DWG NO. : (WW4)-2 - [2JT-1]	REV: 0

12

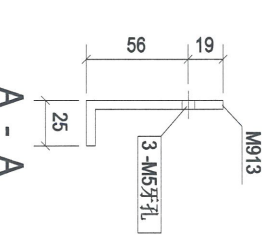
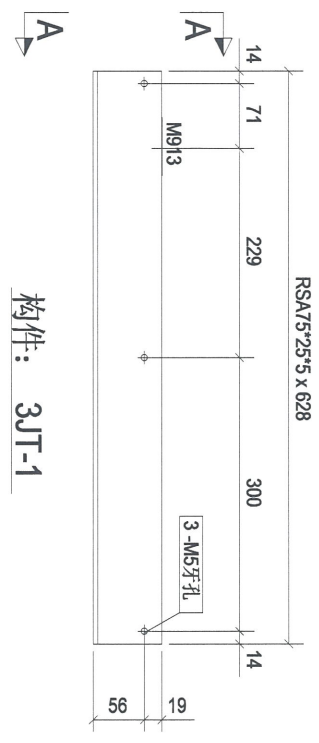

构件: 3JT-1

构件编号	3JT-1	构件数量	1	构件重量	2.34
部件编号	规格(mm)	长度(mm)	数量	单重(kg)	共重(kg)
M913	RSA75*25*5	628	1	2.34	2.34
合计:					2.34

0	第1次报批	2018-11-02
Rev	Description	Date

PROJECT:
 PROPOSED SITE C1
 DEVELOPMENT AT AREA 86,
 TKOIL 70/RP TSEUNG KWAN O,
 NEW TERRITORIES

CLIENT:
美特铝业有限公司
 MIDU Aluminium Manufacturing Ltd.
 Units 6-13, Sunray Industrial Centre, 1/F
 610 Chin Kwo Ling Road, Kowloon
 Tel: (2369)2111-4 Fax: (232)7272885

银同有限公司
 Silver Town Limited
 Tel: 0189-83359868 Fax: 0189-83359954
 E-MAIL: ADDRESS@silvertown.hk, SALES@S

DRAWING TITLE :
[3JT-1]

CAD File Name :

Designed by	
Drawn by	
Reviewed by	
Approved by	
Scale	

DWG NO: (MM4)-2 - [3JT-1]

REV	0
-----	---

13

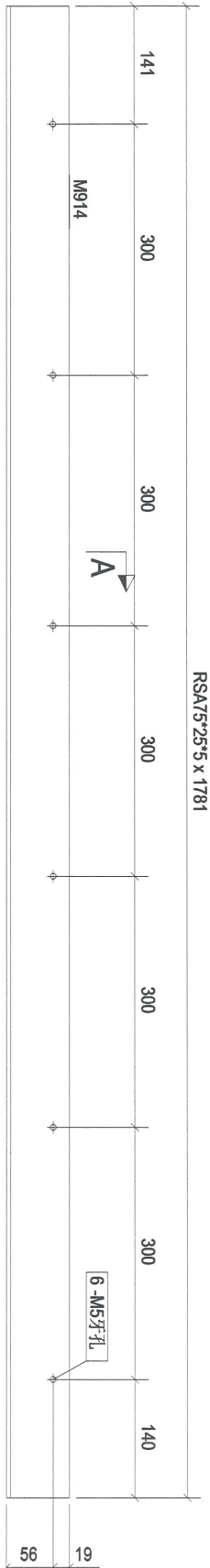

构件: 3JT-2

构件编号	3JT-2	构件数量	1	构件重量	6.64
部件编号	规格(mm)	长度(mm)	数量	单重(kg)	共重(kg)
M914	RSA75*25*5	1781	1	6.64	6.64
合计:					6.64
					表面积(m ²)
					0.36

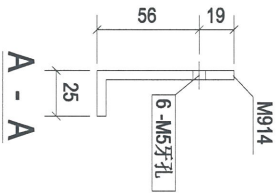

Rev	Description	Date
0	第1次报批	2018-11-02

PROJECT:
PROPOSED SITE C1
DEVELOPMENT AT AREA 86,
TKOIL 70 RP, TSEUNG KWAN O,
NEW TERRITORIES

CLIENT:
美特铝质有限公司
MIDI Aluminium Fabrication Ltd.
Units 6-8, Sunny Industrial Centre, 1/F
610 Chia Kwo Ling Road, Kowloon
Tel: 23469271-4 Fax: (852) 27276886

银同有限公司
Silver Town Limited
Tel: 0769-83354868 Fax: 0769-83359954
E-Mail: 4008835@silvertown.hk.com

DRAWING TITLE :
[3JT-2]

CAD File Name :	
Designed by	
Drawn by	
Reviewed by	
Approved by	
Scale	
DWG NO. : (MM4)-2 - [3JT-2]	REV
	0

14

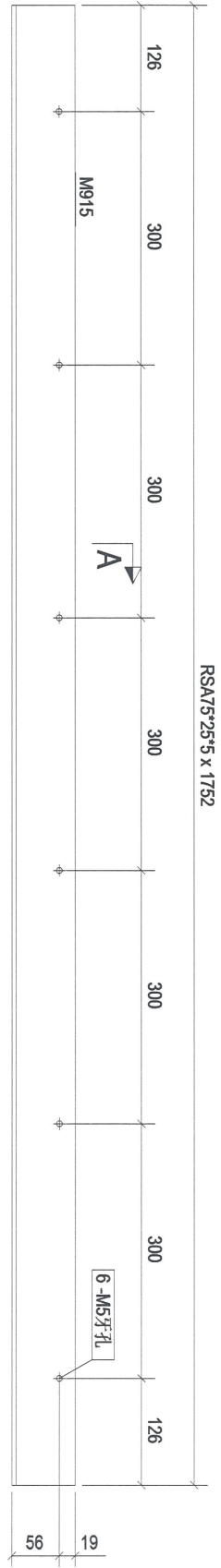

RSA75*25*5 x 1752

构件: 3JT-3

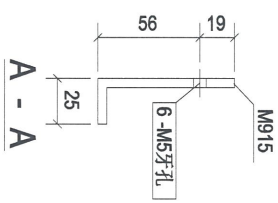

构件编号	3JT-3	构件数量	1	构件重量	6.53
部件编号	规格(mm)	长度(mm)	数量	单重(kg)	共重(kg)
M915	RSA75*25*5	1752	1	6.53	6.53
合计:					6.53
				表面积(m ²)	0.35

Rev	Description	Date
0	第1次报批	2018-11-02

PROJECT:
 PROPOSED SITE C1
 DEVELOPMENT AT AREA 86,
 TKO1L70 RP, TSEUNG KWAN O,
 NEW TERRORIES

CLIENT:
美特铝质有限公司
 MIDT Aluminium Fabricators Ltd.
 Unit 6-8, Sunny Industrial Centre, 1/F
 610 Chee Kwo Ling Road, Kowloon
 Tel: 2549271-4 Fax: (852) 27727686

银同有限公司
 Silver Town Limited
 Tel: 0769-43354988 Fax: 0769-43359954
 E-MAIL: ADDRESS@silvertown.hk, SALES@SILVERTOWN.COM

DRAWING TITLE :
[3JT-3]

CAD File Name :

Designed by	
Drawn by	
Reviewed by	
Approved by	
Scale	

DWG NO.: (MM4)-2 - [3JT-3]

REV	0
-----	---

构件编号	3JT-4	构件数量	1	构件重量	6.43
部件编号	规格(mm)	长度(mm)	数量	单重(吨)	表面积(m ²)
M916	RSA75*25*5	1724	1	6.43	0.35
合计:				6.43	

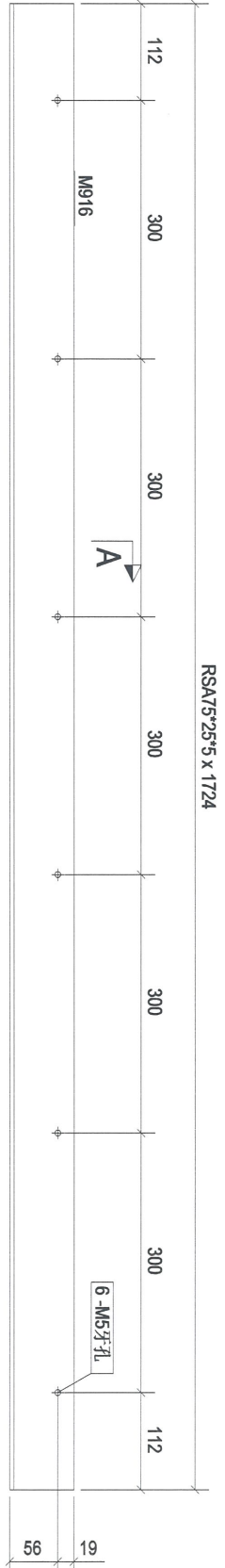

构件: 3JT-4

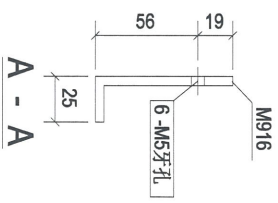

Rev.	Description	Date
0	第一次报批	2018-11-02

PROJECT: PROPOSED SITE C1 DEVELOPMENT AT AREA N6, TKO TL 70 R2 TSEUNG KWAN O, NEW TERRITORIES

CLIENT: 美特铝业有限公司
MIDI Aluminium Manufacturing Ltd.
Units 6-8, Sunny Industrial Centre, 1/F
610 Chea Kwo Ling Road, Kowloon
Tel: (2348)211-4 Fax: (852)27270685

Silver Town Limited
Tel: 0789-83354988 Fax: 0789-83359954
E-MAIL: ADDRESS: silvertown@163.com

DRAWING TITLE: [3JT-4]

Designated by	Drawn by	Reviewed by	Approved by	Scale

CAD File Name :
DWG NO.: (MM)A-2 - [3JT-4]



76

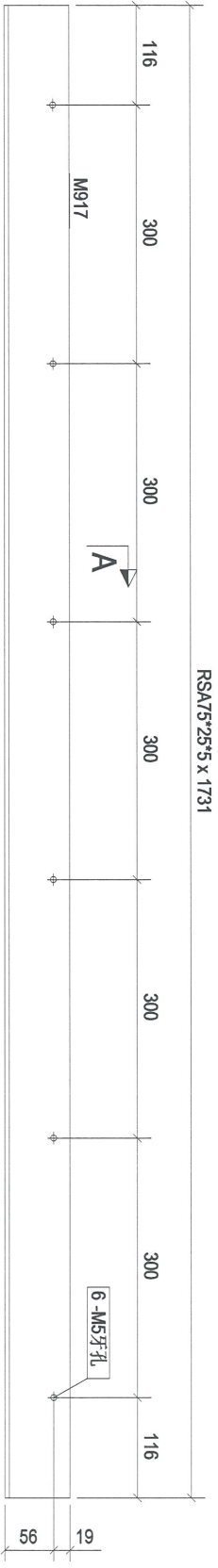

构件: 3JT-5

构件编号	3JT-5	构件数量	1	构件重量	6.46
部件编号	规格(mm)	长度(mm)	数量	单重(kg)	共重(kg)
M917	RSAT5*25*5	1731	1	6.46	6.46
合计:					6.46
				表面积(m ²)	0.35

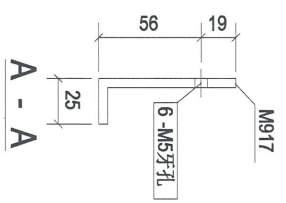

Rev	Description	Date
0	第1次报批	2018-11-02

PROJECT:
 PROPOSED SITE C1
 DEVELOPMENT AT AREA 86,
 TKOIL TO RP, TSEILING KWAN O,
 NEW TERRITORIES

CLIENT:
美特鋁質有限公司
 MIDT Aluminium Fabricators Ltd.
 Units 6-8, Sunny Industrial Centre, 1/F
 870 Chin Kwo Ling Road, Kowloon
 Tel: 2348921-4 Fax: (852) 7727886

银同有限公司
 Silver Town Limited
 Tel: 0759-8335968 Fax: 0759-8335954
 E-MAIL: ADDRESS@silvertown.hk

DRAWING TITLE:
[3JT-5]

CAD File Name :

Designated by	Drawn by	Reviewed by	Approved by	Scale

DWG NO.: (WW4)-2 - [3JT-5]

REV
0

构件编号	3JT-6	构件数量	1	构件重量	6.40
部件编号	M918	规格(mm)	1717	数量	1
		长度(mm)	1717	单重(g)	6.40
				共重(g)	6.40
				表面积(m ²)	0.34
合计:				6.40	

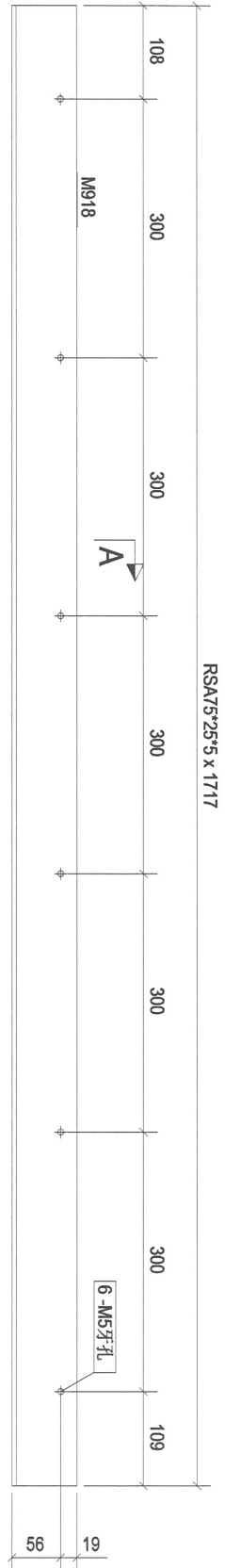

构件: 3JT-6

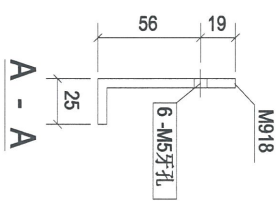

Rev	Description	Date
0	第1次报批	2018-11-02

PROJECT:
 PROPOSED SITE C1
 DEVELOPMENT AT AREA 86,
 TKOIL TO RP, TSEING KWAN O,
 NEW TERRORIES

CLIENT:
美特鋁質有限公司
 MIDT ALUMINIUM FABRICATORS LTD.
 Unit 6-8, Sunny Industrial Centre, 1/F
 610 Chee Kwo Ling Road, Kowloon
 Tel: 25499211-4 Fax: (852) 7727886

银同有限公司
 Silver Town Limited
 Tel: 0759-83354688 Fax: 0759-83359954
 E-Mail: ADDRESS@silvertown.hk, SA.COM

DRAWING TITLE:
[3JT-6]

CAD File Name :	
Designed by	
Drawn by	
Reviewed by	
Approved by	
Scale	
DWG NO. : (MM)A-2 - [3JT-6]	REV
	0

构件编号	3JT-7	构件数量	1	构件重量	6.15
部件编号	规格(mm)	长度(mm)	数量	单重(吨)	共重(吨)
M919	RSA75*25*5	1649	1	6.15	6.15
合计:					6.15
				表面积(m ²)	0.33

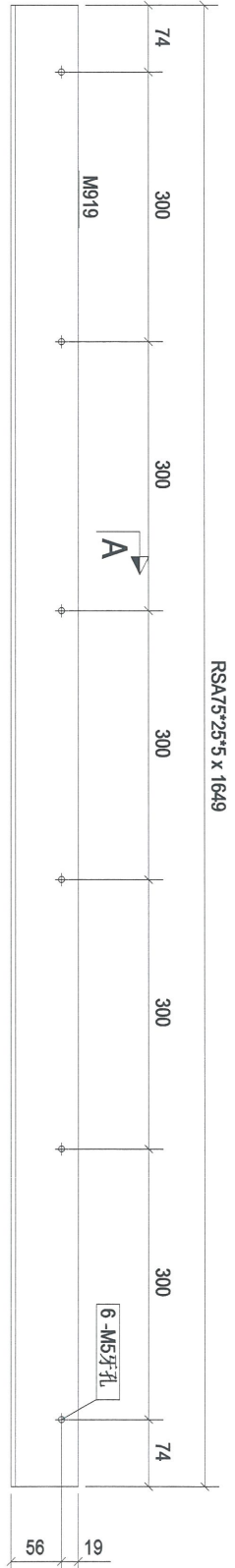

构件: 3JT-7

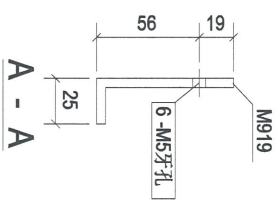

Rev	Description	Date
0	第1次报批	2018-11-02

PROJECT:
 PROPOSED SITE C1
 DEVELOPMENT AT AREA 86,
 TKOIL 70 RP, TSEANG KWAN O,
 NEW TERRITORIES

CLIENT:
美特铝质有限公司
 MIDT Aluminium Fabricators Ltd.
 Unit 6-8, Sunray Industrial Centre, 1/F
 610 Chee Kwo Ling Road, Kowloon
 Tel: (852) 492711-4 Fax: (852) 7727686

银同有限公司
 Silver Town Limited
 Tel: 0759-8335468 Fax: 0759-8339954
 E-MAIL: ADDRESS: gpltd@kwhs.hk, SCL.COM

DRAWING TITLE:
[3JT-7]

CAD File Name :	
Designed by	
Drawn by	
Reviewed by	
Approved by	
Scale	
DWG NO.:	(MM)A-2 - [3JT-7]
REV	0



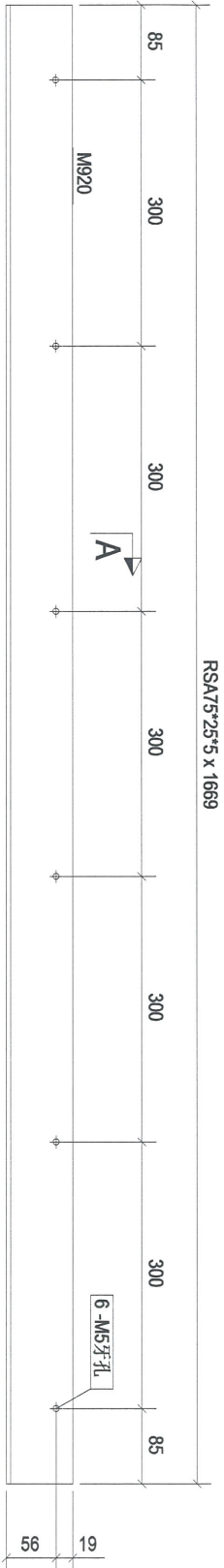

构件: 3JT-8

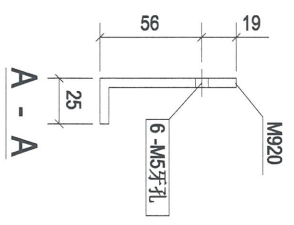

构件编号:	3JT-8	构件数量:	1	构件重量:	6.22
部件编号	规格(mm)	长度(mm)	数量	单重(kg)	共重(kg)
M920	RSA75*25*5	1669	1	6.22	6.22
合计:					6.22
				表面积(m ²)	0.33

Rev	Description	Date
0	第1次报批	2018-11-02

PROJECT:
 PROPOSED SITE C1
 DEVELOPMENT AT AREA 88,
 TKOIL TO RP, TSEUNG KWAN O,
 NEW TERRORIES

CLIENT:
美特铝质有限公司
 MIDT Aluminium Fabrication Ltd.
 Units 6-8, Sunny Industrial Centre, 1/F
 610 Chee Kwo Ling Road, Kowloon
 Tel: 2369271-4 Fax: (852) 2727885

银同有限公司
 Silver Town Limited
 Tel: 0759-6335968 Fax: 0759-6335954
 E-Mail: ADDRESS@silvertown.hk, SA.SCOVA

DRAWING TITLE:
[3JT-8]

CAD File Name :

Scale	REV
	0

DWG NO.: (MM4)-2 - [3JT-8]

构件编号	3JT-9	构件数量	1	构件重量	6.55
部件编号	规格(mm)	长度(mm)	数量	单重(kg)	共重(kg)
M921	RSA75*25*5	1756	1	6.55	6.55
合计:					6.55

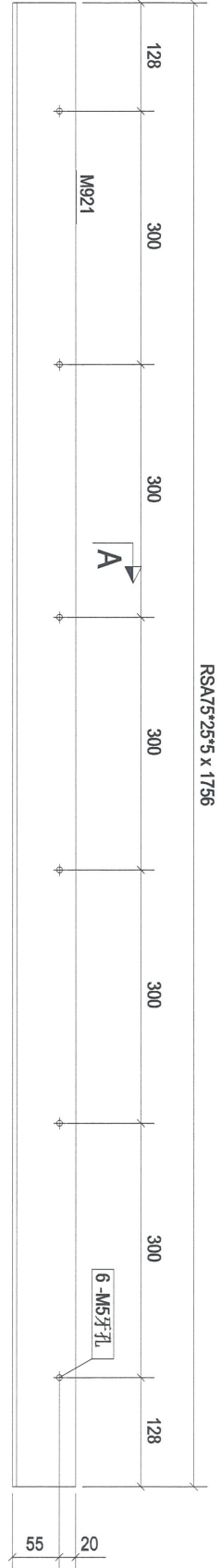

构件: 3JT-9

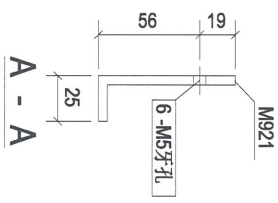

Rev.	Description	Date
0	第一次报批	2018-11-02

PROJECT:
 PROPOSED SITE C1
 DEVELOPMENT AT AREA B6,
 TKOIL 70/RP TSEUNG KWAN O,
 NEW TERRITORIES

CLIENT:
 **美特铝业有限公司**
 MIDD Aluminum Fabricator Ltd.
 Units 6-8, Sunny Industrial Centre, 7/F
 610 Chee Kwo Ling Road, Kowloon
 Tel: 23689211-14 Fax: (852) 27171666

 **银同有限公司**
 Silver Town Limited
 Tel: 0753-83354988 Fax: 0753-8335954
 E-MAIL: ADDRESS@silvertown.com.hk

DRAWING TITLE:
[3JT-9]

CAD File Name :

Designed by	
Drawn by	
Reviewed by	
Approved by	
Scale	

DWG NO.: (MM4)-2 - [3JT-9]

RV	0
----	---

30

1

构件编号	3JT-10	构件数量	1	构件重量	3.01
部件编号	规格(mm)	长度(mm)	数量	单重(g)	共重(g)
M960	RSA100*50*6	443	1	3.01	3.01
合计:					3.01
表面积(m ²)	0.11				

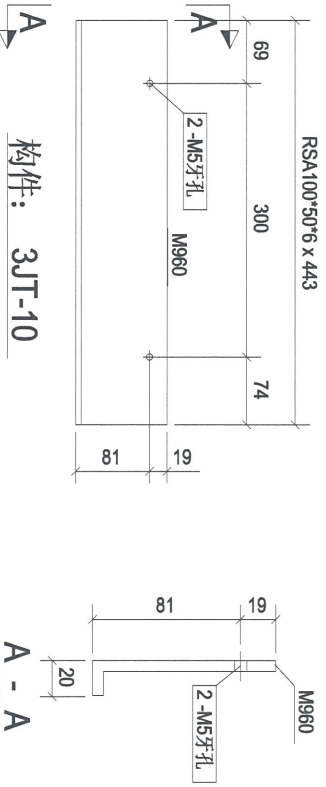

构/件: 3JT-10

Rev	Description	Date
0	第1次报批	2018-11-02

PROJECT:
 PROPOSED SITE C1
 DEVELOPMENT AT AREA 08,
 TKOHL 70 RP TSENGS KWAN O,
 NEW TERRITORIES

CLIENT:
美特铝质有限公司
 MIDU ALUMINIUM FABRICATORS LTD.
 Unit 6-8, Sunray Industrial Centre, 1/F
 610 Chai Kwo Ling Road, Kowloon
 Tel: 23469211-4 Fax: (852) 27270885

银同有限公司
 Silver Town Limited
 Tel: 0759-83354681 Fax: 0759-83359954
 E-MAIL ADDRESS: sg@silvertown.com.hk

DRAWING TITLE :
[3JT-10]

CAD File Name :	
Designed by	
Drawn by	
Reviewed by	
Approved by	
Scale	
DWG NO. : (MM)4-2 - [3JT-10]	REV 0

1

1

22

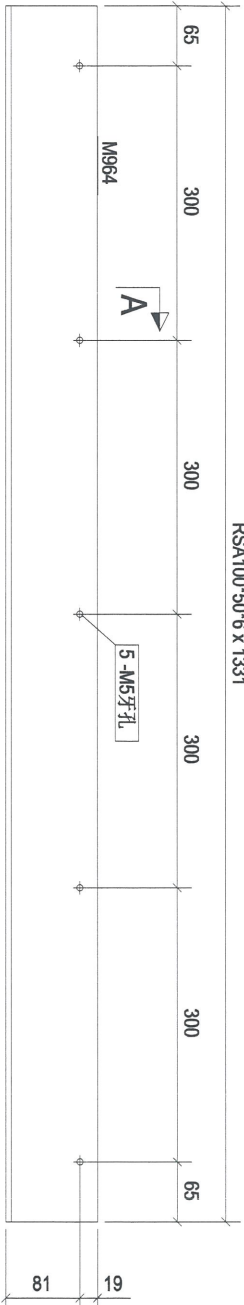

构件: 3JT-11

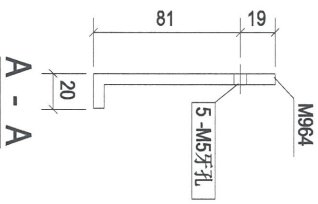

构件编号	规格(mm)	长度(mm)	数量	单重(kg)	共重(kg)	表面积(m ²)
M964	RSA100*50*6	1331	1	9.03	9.03	0.32
合计:					9.03	

Rev	Description	Date
0	第1次报批	2018-11-02

PROJECT:
 PROPOSED SITE C1
 DEVELOPMENT AT AREA 86,
 TKOIL TO RP TSEUNG KWAN O,
 NEW TERRORIES

CLIENT:
美特铝质有限公司
 MIDT ALUMINIUM FABRICATORS LTD.
 Unit 6-8, Sunny Industrial Centre, 1/F
 610 Chee Kwo Ling Road, Kowloon
 Tel: 2549211-4 Fax: (852) 7727885

银同有限公司
 Silver Town Limited
 Tel: 0759-43354688 Fax: 0759-43359654
 E-MAIL: ADDRESS@silvertown.hk WWW.SILVERTOWN.COM

DRAWING TITLE:
[3JT-11]

CAD File Name :

Scale	REV
	0

DWG NO.: (MM4)-2 - [3JT-11]

构件编号	3JT-12	构件数量	1	构件重量	9.76
部件编号	规格(mm)	长度(mm)	数量	单重(吨)	表面积(m ²)
M965	RSA100*50*6	1439	1	9.76	0.34
合计:				9.76	

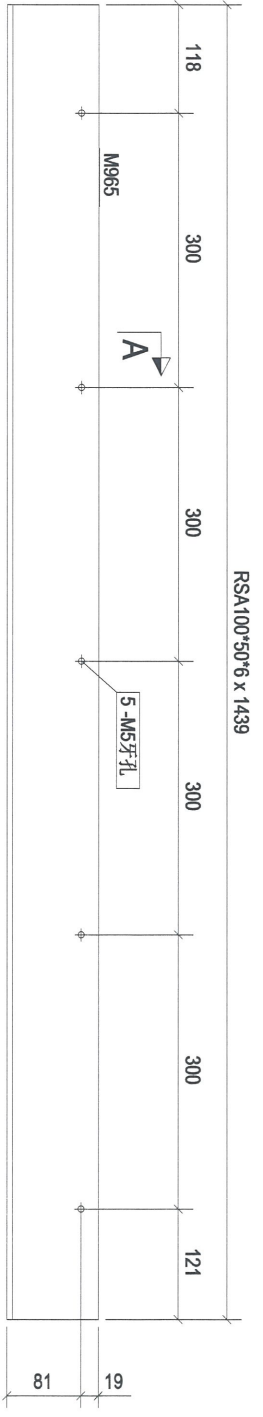

构件: 3JT-12

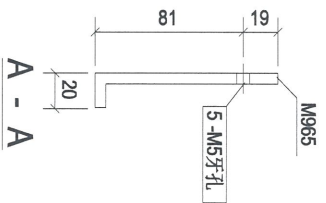

Rev.	Description	Date
0	第1次报批	2018-11-02

PROJECT:
 PROPOSED SITE C1
 DEVELOPMENT AT AREA 08,
 TKOYL 70 RP TSEUNG KWAN O,
 NEW TERRITORIES

CLIENT:
美特铝质有限公司
 MIDT Aluminium Manufacturers Ltd.
 Units 6-8, Sunny Industrial Centre, 1/F
 610 Chea Kwo Ling Road, Kowloon
 Tel: 23489211-4 Fax: (852) 27270685

银同有限公司
 Silver Town Limited
 Tel: 0789-43354968 Fax: 0789-43359954
 E-MAIL: ADDRESS: silvertown@stl.com.hk

DRAWING TITLE :
[3JT-12]

CAD File Name :

Designed by	
Drawn by	
Reviewed by	
Approved by	
Scale	

DWG NO.: (MM)A-2 - [3JT-12]

REV	0
-----	---

23

1

54

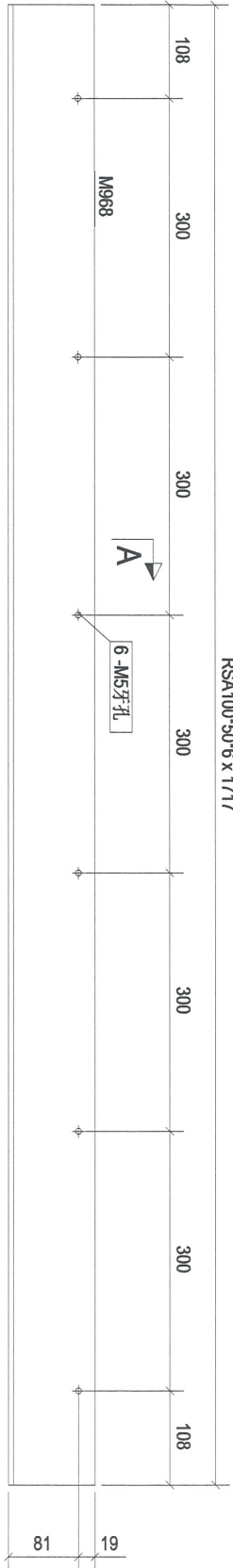

RSA100*50*6 x 1717

构件: 3JT-13

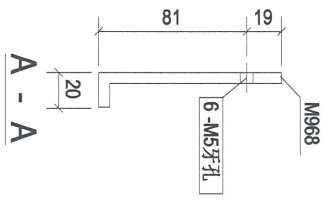

构件编号	3JT-13	构件数量	7	构件重量	11.65
部件编号	规格(mm)	长度(mm)	数量	单重(kg)	共重(kg)
M968	RSA100*50*6	1717	1	11.65	11.65
合计:					11.65
					表面积(m ²)
					0.41

Rev	Description	Date
0	第1次报批	2018-11-02

PROJECT:
 PROPOSED SITE C1
 DEVELOPMENT AT AREA 86,
 TKOIL 70/RP TSEUNG KWAN O,
 NEW TERRITORIES

CLIENT:
美特铝质有限公司
 MIDT Aluminium Fabricators Ltd.
 Units 6-8, Sunray Industrial Centre, 1/F
 610 Chee Kwo Ling Road, Kowloon
 Tel: 2348211-4 Fax: (852) 2727885

银同有限公司
 Silver Town Limited
 Tel: 0769-8335068 Fax: 0769-8335964
 E-MAIL: ADDRESS: silvertown@stl.com.hk

DRAWING TITLE :
[3JT-13]

CAD File Name :

Scale	REV
	0

DWG NO.: (MM)A-2 - [3JT-13]

构件编号	3JT-14	构件数量	2	构件重量	10.85
部件编号	规格(mm)	长度(mm)	数量	单重(kg)	共重(kg)
M969	RSA100*50*6	1600	1	10.85	10.85
合计:				10.85	0.38

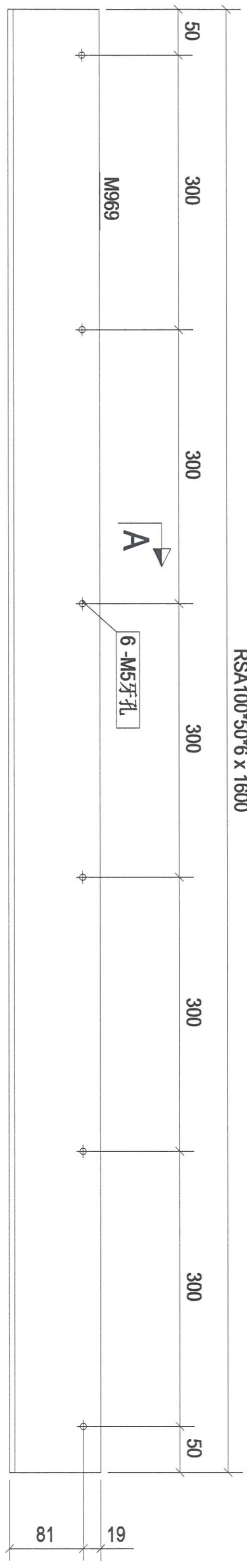

构件: 3JT-14

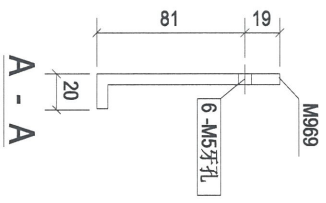

57

Rev.	Description	Date
0	第一次报批	2016-11-02

PROJECT: PROPOSED SITE C1
DEVELOPMENT AT AREA 88,
TKOTL 70 RP, TSEUNG KWAN O,
NEW TERRITORIES

CLIENT: 美特铝业有限公司
MIDI ALUMINIUM FABRIKATION LTD.
Units 6-8, Sunny Industrial Centre, 1/F
610 Chee Kwoong Road, Kwun Tong
Tel: 23469211-4 Fax: (852) 7727868

银同有限公司
Silver Town Limited
Tel: 0759-83354968 Fax: 0759-83359954
E-MAIL: ADDRESS@silvertown.hk, CHINA

DRAWING TITLE: [3JT-14]

CAO File Name:	
Designed by:	
Drawn by:	
Reviewed by:	
Approved by:	
Scale:	
DMG NO.: (MM4)-2 - [3JT-14]	REV 0

26

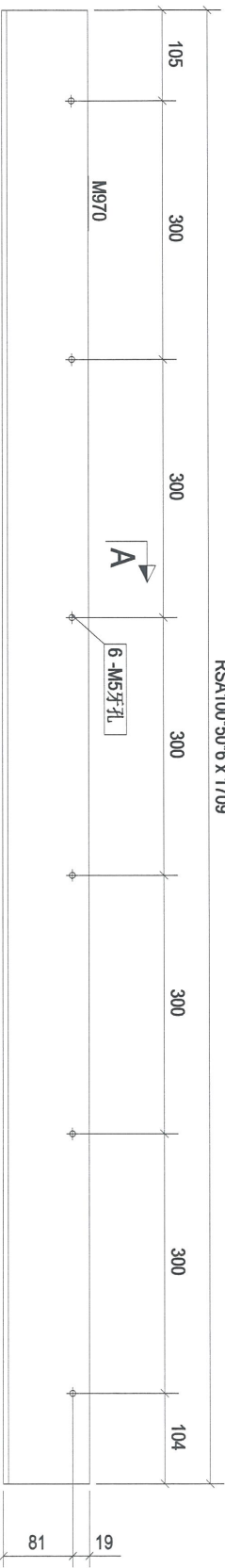

RSA100*50*6 x 1709

构件: 3JT-15

构件编号	规格(mm)	长度(mm)	数量	单重(kg)	共重(kg)	表面积(m ²)
M970	RSA100*50*6	1709	1	11.59	11.59	0.41
合计:				11.59	11.59	

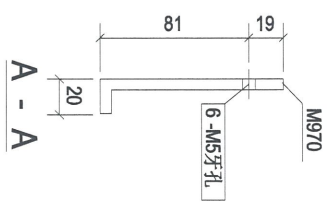

Rev.	Description	Date
0	第一次出图	2018-11-02

PROJECT:
 PROPOSED SITE C1
 DEVELOPMENT AT AREA 88,
 TKO TL TO RP TSEUNG KWAN O,
 NEW TERRITORIES

CLIENT:
美特铝业有限公司
 MIDJ Aluminium Fabricator Ltd.
 Unit 8, 8, Sanyong Industrial Centre, 1/F,
 610 Cheong Cheong Street,
 Tel: 23488211-4 Fax: (852) 2727856

银同有限公司
 Silver Town Limited
 Tel: 0753-8333888 Fax: 0753-8333954
 E-MAIL: ADDRESS@silvertown.hk.com

DRAWING TITLE:
[3JT-15]

CAD File Name :

Designed by	
Drawn by	
Reviewed by	
Approved by	
Scale	

DWG NO.: (MMW4)-2 - [3JT-15]

REV	0
-----	---

27

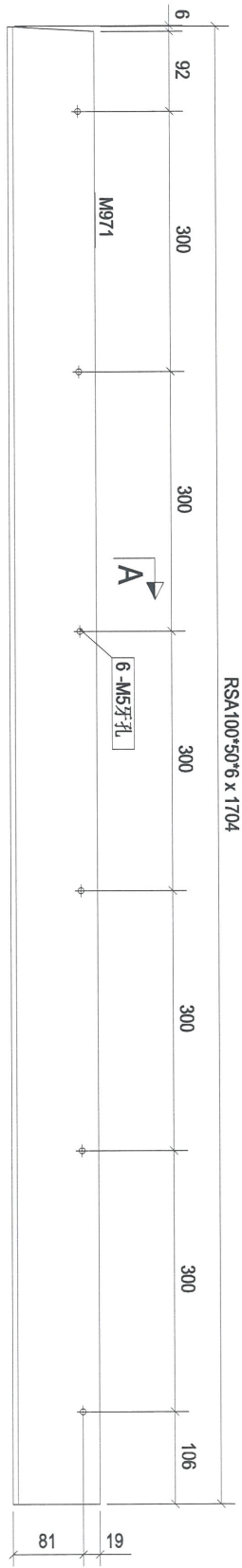

RSA100*50*6 x 1704

构件: 3JT-16

构件编号	规格(mm)	长度(mm)	数量	单重(kg)	共重(kg)	表面积(m ²)
M971	RSA100*50*6	1704	1	11.54	11.54	0.41
合计:				11.54	11.54	

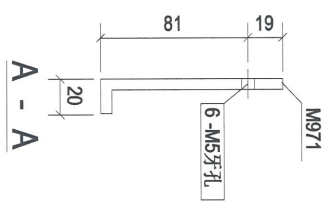

0	第1次报批	2018-11-02
Rev.	Description	Date
PROJECT: PROPOSED SITE C1 DEVELOPMENT AT AREA 88, TKO TL 70 RP TSEUNG KWAN O, NEW TERRITORIES		
CLIENT: 美特铝业有限公司 M.T. Aluminium Fabricator Ltd. Units 6 & 8, Sun Chai Industrial Estate, 510 Chee Kwo Ling Road, Kwai Tsou, Tel: (2348)9211-4 Fax: (852)27277686		
DRAWING TITLE: [3JT-16]		
CAD File Name:		
Designed by:		
Drawn by:		
Reviewed by:		
Approved by:		
Scale:		
DWG NO.: (MM4)-2 - [3JT-16]		REV: 0

CLIENT: 美特铝业有限公司
M.T. Aluminium Fabricator Ltd.
Units 6 & 8, Sun Chai Industrial Estate,
510 Chee Kwo Ling Road, Kwai Tsou,
Tel: (2348)9211-4 Fax: (852)27277686

银同有限公司
Silver Town Limited
Tel: (852) 35335868 Fax: (852) 35335954
E-Mail: address@silvertown.com.hk

构件编号	3JT-17	构件数量	1	构件重量	11.43
部件编号	规格(mm)	长度(mm)	数量	单重(kg)	共重(kg)
M972	RSA100*50*6	1690	1	11.43	11.43
合计:				11.43	0.40

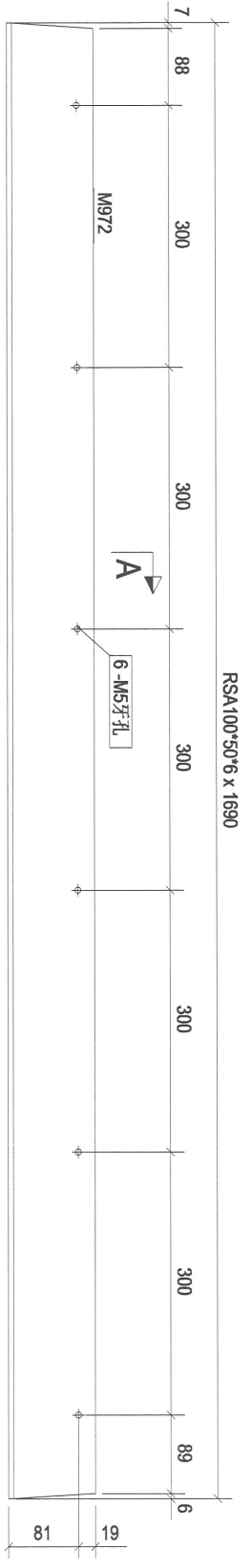

构件: 3JT-17

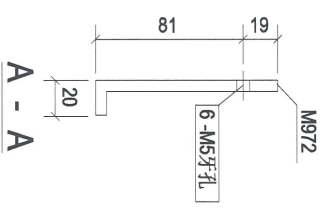

Rev.	Description	Date
0	第一次报数	2016-11-02

PROJECT:
 PROPOSED SITE C1
 DEVELOPMENT AT AREA 86,
 TKOHL 70 RP, TSEUNG KWAN O,
 NEW TERRITORIES

CLIENT:
美特铝业有限公司
 MIDT ALUMINIUM FABRICATOR TM
 Units 6-8, Sunny Industrial Centre, 1/F
 610 Chee Koo Ling Road, Kwai Liong
 Tai, 2408211-4, Fax: (852) 27227086

银同有限公司
 Silver Town Limited
 Tel: 0789-83334968 Fax: 0789-83339954
 E-MAIL: ADDRESS@silvertown.ltd.com

DRAWING TITLE:
[3JT-17]

CAD File Name :

Designed by	
Drawn by	
Reviewed by	
Approved by	
Scale	

DWGNO: (MM4)-2 - [3JT-17]

REV	0
-----	---

28

1

29

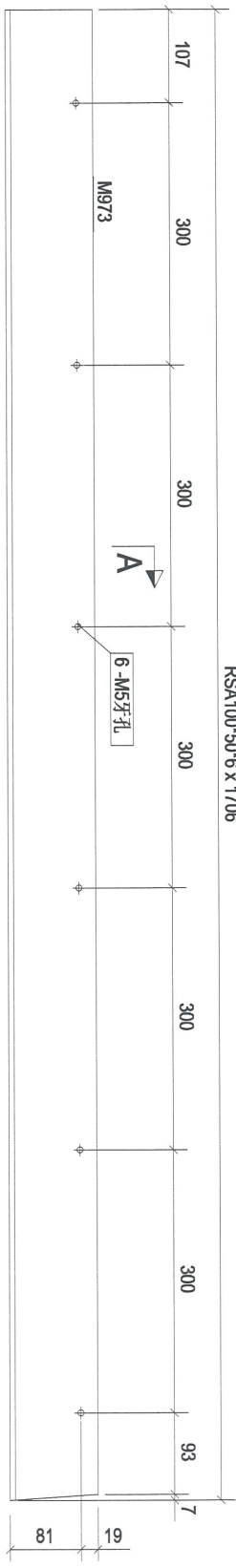

RSA100*50*6 x 1706

构件: 3JT-18

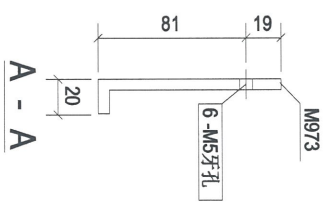

构件编号	3JT-18	构件数量	1	构件重量	11.56
部件编号	规格(mm)	长度(mm)	数量	单重(kg)	共重(kg)
M973	RSA100*50*6	1706	1	11.56	11.56
					表面积(m ²)
					0.41
合计:				11.56	

Rev.	Description	Date
0	首次推批	2018-11-02

PROJECT: PROPOSED SITE C1
DEVELOPMENT AT AREA 08,
TKOIT TO RP TSEUNG KWAN O,
NEW TERRITORIES

CLIENT: 美特铝业有限公司
MIDI Aluminium Fabricator Ltd.
Unit 6-8, Sunny Industrial Centre, 1/F,
810 Chee Kwo Tong Road, Kwun Tong,
Tel: (852) 27272856 Fax: (852) 27272856

银同有限公司
Silver Town Limited
Tel: 0753-8333868 Fax: 0753-8333954
E-Mail: address@silvertown.hk.com

DRAWING TITLE: [3JT-18]

CAD File Name :

Designed by	
Drawn by	
Reviewed by	
Approved by	
Scale	

DWG NO.: (MM4)-2 - [3JT-18]

REV.	0
------	---

330

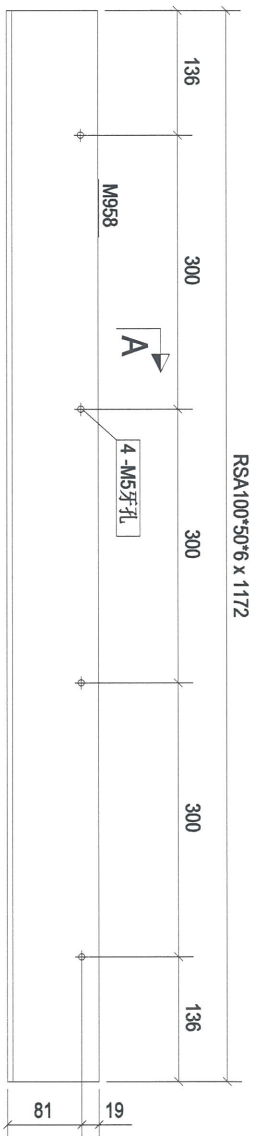

构件: 4JT-1

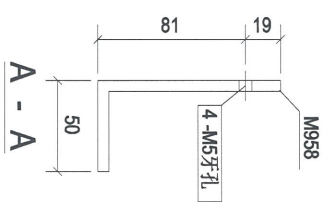

构件编号	规格(mm)	长度(mm)	数量	单重(kg)	共重(kg)	表面积(m ²)
M958	RSA100°50°6	1172	1	7.95	7.95	0.35
合计:				7.95		

Rev.	Description	Date
0	第一次报数	2018-11-02

PROJECT: PROPOSED SITE C1
DEVELOPMENT AT AREA 86,
TKOIL TO RP, TSEUNG KWAN O,
NEW TERRITORIES

CLIENT: 美特铝业有限公司
MIDI Aluminium Fabricator Ltd.
Units 6-8, Sunny Industrial Centre, 1/F,
810 Chee Koo Ling Road, Kwai Tsou
Tel: 23692111-4 Fax: (852) 27228586

银同有限公司
Silver Town Limited
Tel: 0789-8335968 Fax: 0789-8335954
E-MAIL: ADDRESS@silvertown.hk, CHINA

DRAWING TITLE: [4JT-1]

Designed by	
Drawn by	
Reviewed by	
Approved by	
Scale	
DWG NO: (MM4)-2 - [4JT-1]	REV: 0

31

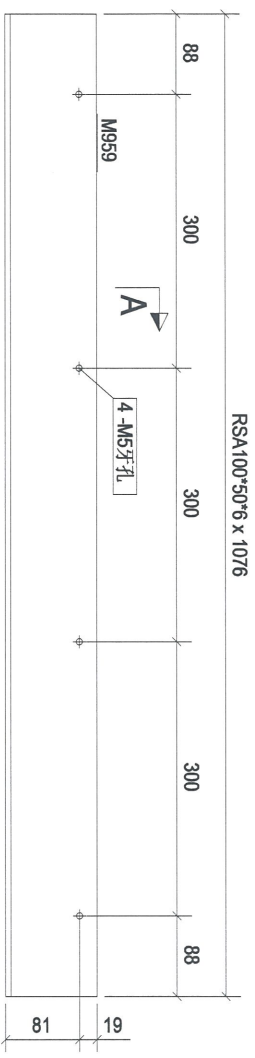

A

构件: 4JT-2

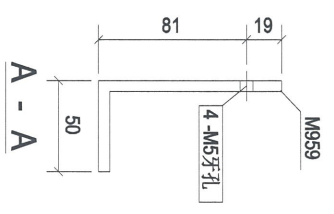

A - A

构件编号	4JT-2	构件数量	2	构件重量	7.30
部件编号	规格(mm)	长度(mm)	数量	单重(kg)	共重(kg)
M959	RSA100*50*6	1076	1	7.30	7.30
合计:				7.30	0.32

Rev.	Description	Date
0	第一次报数	2018-11-02

PROJECT: PROPOSED SITE C1
DEVELOPMENT AT AREA 86,
TKOIL TO RP, TSEUNG KWAN O,
NEW TERRITORIES

CLIENT: 美特铝业有限公司
MIDI Aluminium Fabrication Ltd.
Units 6 & 8, Sunny Industrial Centre, V/F
D10, 110 King Road, Tseung Kwan O,
New Territories, Hong Kong
Tel: 23699211-4 Fax: (852) 2727886

银同有限公司
Silver Town Limited
Tel: 0789-8333998 Fax: 0789-8333994
E-MAIL: ADDRESS@silvertown.com.hk

DRAWING TITLE: [4JT-2]

CAO File Name :

Scale	REV
	0

DWG NO.: (MM4)-2 - [4JT-2]

32

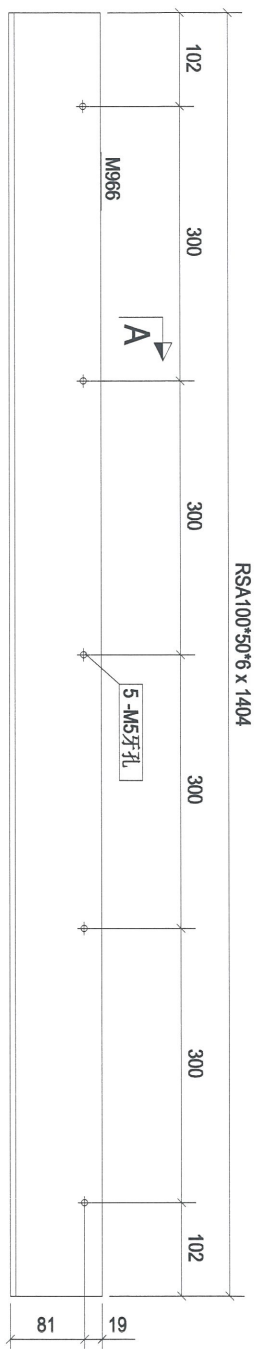

构件: 4JT-3

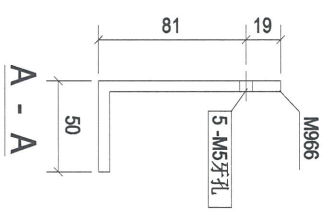

部件编号	规格(mm)	长度(mm)	数量	单重(kg)	共重(kg)	表面积(m ²)
M966	RSA100*50*6	1404	1	9.52	9.52	0.42
合计:				9.52		

Rev.	Description	Date
0	首次报批	2018-11-02

PROJECT: PROPOSED SITE C1 DEVELOPMENT AT AREA 86, TKOIL 70 RP, TSEUNG KWAN O, NEW TERRITORIES

CLIENT: 美特铝业有限公司
MIDI ALUMINIUM FABRICATOR LTD.
Units 6 & 8, Sunny Industrial Centre, 1/F,
610 Chee Kwo Jung Road, Kowloon
Tel: 23499211-4 Fax: (852) 27272866

银同有限公司
Silver Town Limited
Tel: 0769-83334968 Fax: 0769-83339954
E-MAIL: ADDRESS@silvertown.com.hk

DRAWING TITLE: [4JT-3]

CAO File Name :

Designed by

Drawn by

Reviewed by

Approved by

Scale

DWG NO.: (MM4)-2 - [4JT-3]

REV	0
-----	---

33

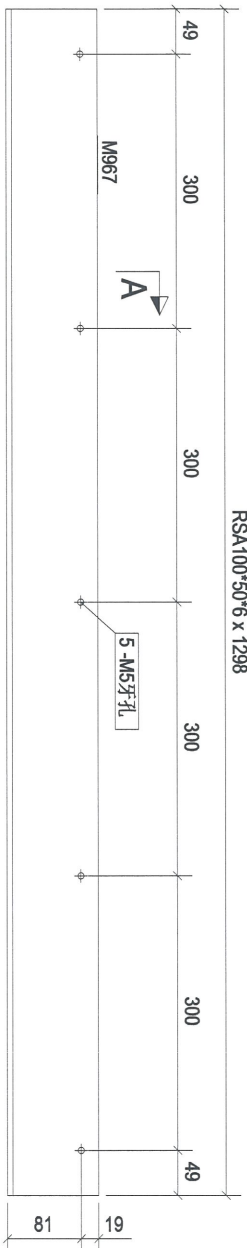

构件: 4JT-4

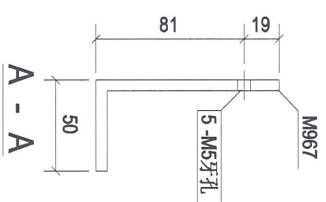

构件编号	4JT-4	构件数量	1	构件重量	8.81
部件编号	规格(mm)	长度(mm)	数量	单重(kg)	共重(kg)
M967	RSA100*50*6	1298	1	8.81	8.81
合计:					8.81

Rev.	Description	Date
0	第一次提报	2016-11-02

PROJECT:
 PROPOSED SITE C1
 DEVELOPMENT AT AREA 86,
 TKO TL 70 RP, TSEUNG KWAN O,
 NEW TERRITORIES

CLIENT:
美特铝业有限公司
 MIDU ALUMINIUM FABRICATOR LTD.
 Units 6-8, Sunny Industrial Centre, 1/F
 619 Chee Koo Ling Road, Kwai Tsing
 Tel: (2686)211-4 Fax: (852)7727066

银同有限公司
 Silver Town Limited
 Tel: (7784) 8335968 Fax: (7784) 8335954
 E-MAIL: ADDRESS@silvertown.com.hk

DRAWING TITLE :
[4JT-4]

CAD File Name :

Designed by	
Drawn by	
Reviewed by	
Approved by	
Scale	

DWG NO.: (MM4)2 - [4JT-4]

REV	0
-----	---

1

34

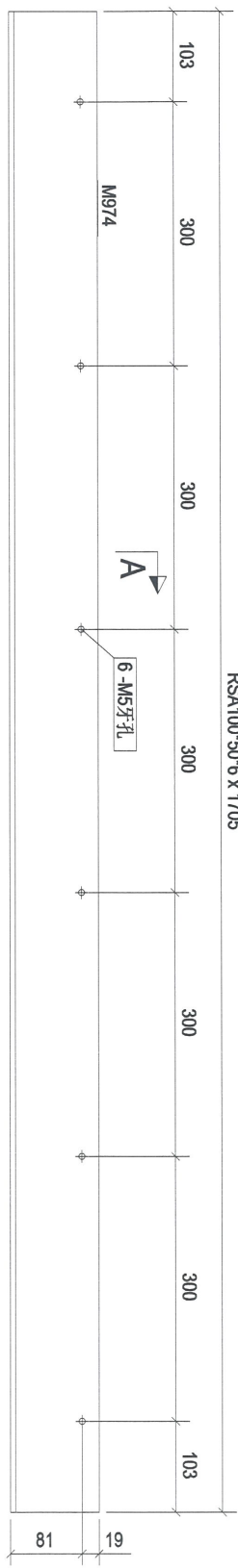

RSA100*50*6 x 1705

构件: 4JT-5

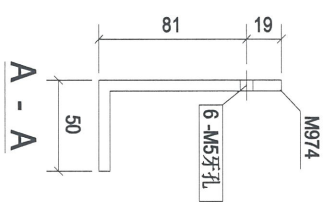

构件编号	4JT-5	构件数量	1	构件重量	11.56
部件编号	规格(mm)	长度(mm)	数量	单重(kg)	共重(kg)
M974	RSA100*50*6	1705	1	11.56	11.56
合计:					11.56

Rev.	Description	Date
0	第一次报批	2018-11-02

PROJECT: PROPOSED SITE C1
DEVELOPMENT AT AREA 86,
TKO TL 70 RP, TSEUNG KWAN O,
NEW TERRITORIES

CLIENT: 美特铝业有限公司
MIDI ALUMINIUM FABRICATOR LTD.
Units 6 & 8, Sanyong Industrial Centre, 1/F,
Sanyong Industrial Estate, 100 Yung Kwoi Road,
Tseung Kwan O, New Territories
Tel: 23689211-4 Fax: (852) 2727856

银同有限公司
Silver Town Limited
Tel: 0789-8333468 Fax: 0789-8333954
E-Mail: address@silvertown.com.hk

DRAWING TITLE: [4JT-5]

CAD File Name :

Designed by

Drawn by

Reviewed by

Approved by

Scale

DWG NO.: (MM4)-2 - [4JT-5]

REV: 0

35

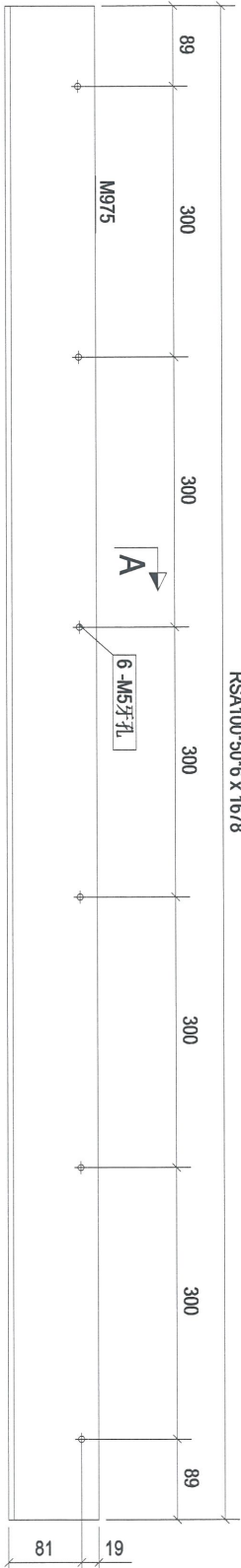

构件: 4JT-6

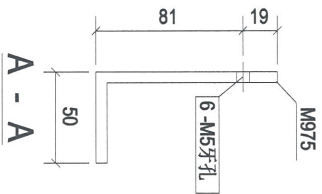

构件编号	4JT-6	构件数量	1	构件重量	11.38
部件编号	规格(mm)	长度(mm)	数量	单重(kg)	共重(kg)
M975	RSA100*50*6	1678	1	11.38	11.38
				表面积(m ²)	0.51
合计:				11.38	

Rev.	Description	Date
0	第一次提批	2018-11-02

PROJECT:
 PROPOSED SITE C1
 DEVELOPMENT AT AREA 88,
 TKOTL 70 RP TSELING KWANO,
 NEW TERRITORIES

CLIENT:
美特铝业有限公司
MIDA ALUMINIUM FABRIKAK Sdn. Bhd.
 5105 S. B. Sulong Industrial Centre, 1/1
 6100 Seremban, Negeri Sembilan, Malaysia
 Tel: 23489211 - 4 Fax: (65) 27272866

银同有限公司
Silver Town Limited
 Tel: 0755-83339881 fax: 0755-83339854
 E-MAIL: ADDRESS@silvertown.com.hk

DRAWING TITLE :
[4JT-6]

CAD File Name :

Designed by	
Drawn by	
Reviewed by	
Approved by	
Scale	

DWG NO: (MM4)-2 - [4JT-6]

REV	0
-----	---

36

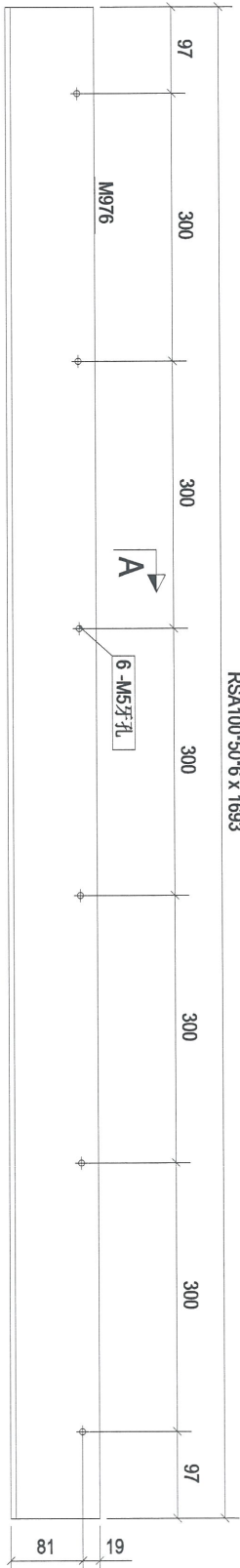

构件: 4JT-7

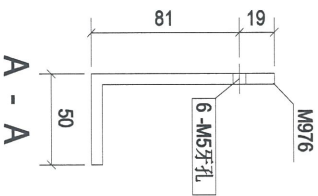

构件编号	规格(mm)	长度(mm)	数量	单重(kg)	共重(kg)	表面积(m ²)
M976	RSA100*50*6	1693	1	11.48	11.48	0.51
合计:			11.48			

Rev.	Description	Date
0	第一次报数	2018-11-02

PROJECT:
 PROPOSED SITE C1
 DEVELOPMENT AT AREA 88,
 KOTL. 70 RP, TSEUNG KWAN O,
 NEW TERRITORIES

CLIENT:
美特铝业有限公司
 MIDJ Aluminium Industries Ltd.
 Unit 6 & 8, Sunny Industrial Centre, 1/F
 610 Chee Kwo Ling Road, Kowloon
 Tel: 22489211-4 Fax: (852) 2727656

银同有限公司
Silver Town Limited
 Tel: 075-8339586 Fax: 075-8339594
 E-Mail: order@silvertown.com.hk

DRAWING TITLE :
[4JT-7]

CAD File Name :

Designed by	
Drawn by	
Reviewed by	
Approved by	
Scale	

DWG NO.: (MM4)-2 - [4JT-7]

REV	0
-----	---

37

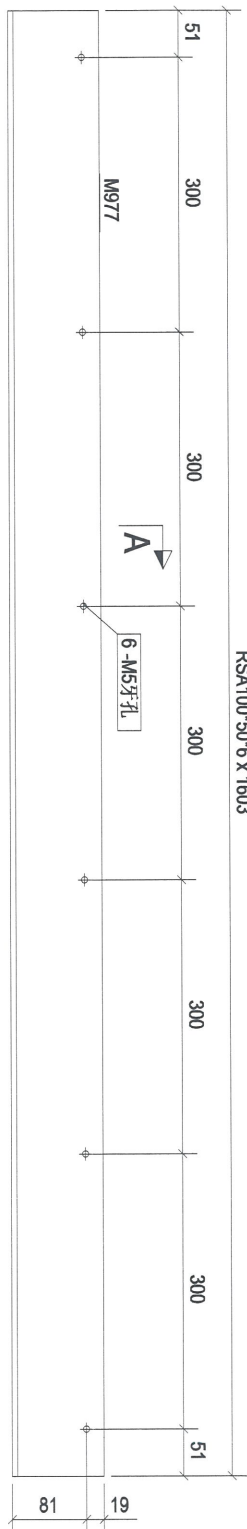

RSA100*50*6 x 1603

构件: 4JT-8

构件编号	规格(mm)	长度(mm)	数量	单重(kg)	共重(kg)	表面积(m ²)
M977	RSA100*50*6	1603	1	10.87	10.87	0.48
合计:				10.87		

Rev.	Description	Date
0	第一次出图	2016-11-02

PROJECT: PROPOSED SITE C1
DEVELOPMENT AT AREA 86,
TKOIL 70 RP, TSEUNG KWAN O,
NEW TERRITORIES

CLIENT: 美特铝业有限公司
MID Aluminium Products Ltd.
Units 6, 8, Sunny Industrial Centre, 1/F
610 Cheong Cheong Street, Kwun Tong
Tel: (852) 27727656

银同有限公司
Silver Town Limited
Tel: (852) 33339888 Fax: (852) 33339594
E-Mail: address@silvertown.com.hk

DRAWING TITLE: [4JT-8]

Designated by	
Drawn by	
Reviewed by	
Approved by	
Scale	
DWG NO.:	(MM4)-2 - [4JT-8]
REV.	0

构件编号	4JT-9	构件数量	1	构件重量	10.20
部件编号	规格(mm)	长度(mm)	数量	单重(kg)	共重(kg)
M978	RSA100*50*6	1503	1	10.20	10.20
合计:					10.20

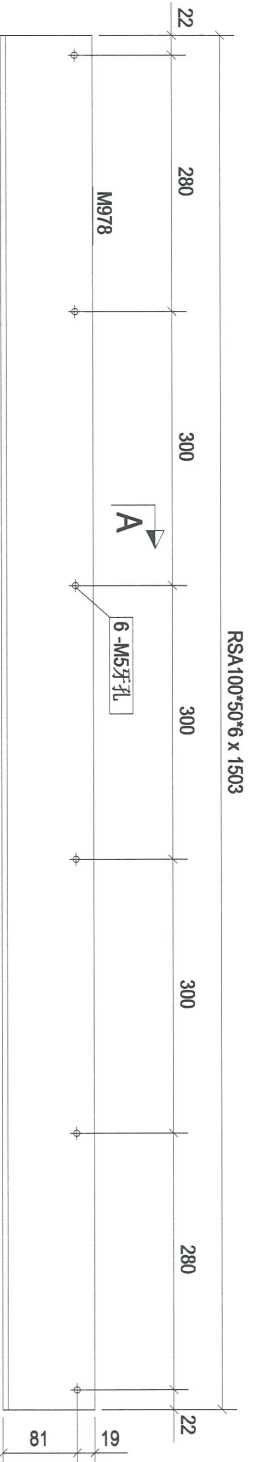

构件: 4JT-9

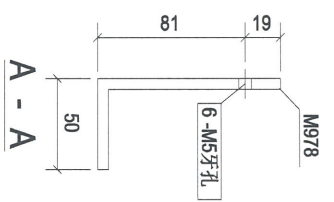

Rev.	Description	Date
0	首次报批	2018-11-02

PROJECT: PROPOSED SITE C1
DEVELOPMENT AT AREA 86,
TKOHL TO RP, TSEUNG KWAN O,
NEW TERRITORIES

CLIENT: 美特铝业有限公司
MIDI Aluminium Fabrication Ltd.
Units 6 & 8, Sunny Industrial Centre, 1/F,
601-602, Tin Yung Road, Tai Po, N.T.
Tel: 22489211-4 Fax: (852) 2722856

Silver Town Limited
Tel: 0769-8339868 Fax: 0769-8339954
E-MAIL: ADDRESS@silvertown.com.hk

DRAWING TITLE: [4JT-9]

Designated by	
Drawn by	
Reviewed by	
Approved by	
Scale	
DWG NO.: (MM4)-2 - [4JT-9]	REV: 0

38

39

构件编号	4JT-10	构件数量	3	构件重量	10.65
部件编号	规格(mm)	长度(mm)	数量	单重(kg)	共重(kg)
M979	RSA100*50*6	1562	1	10.65	10.65
合计:				10.65	0.47

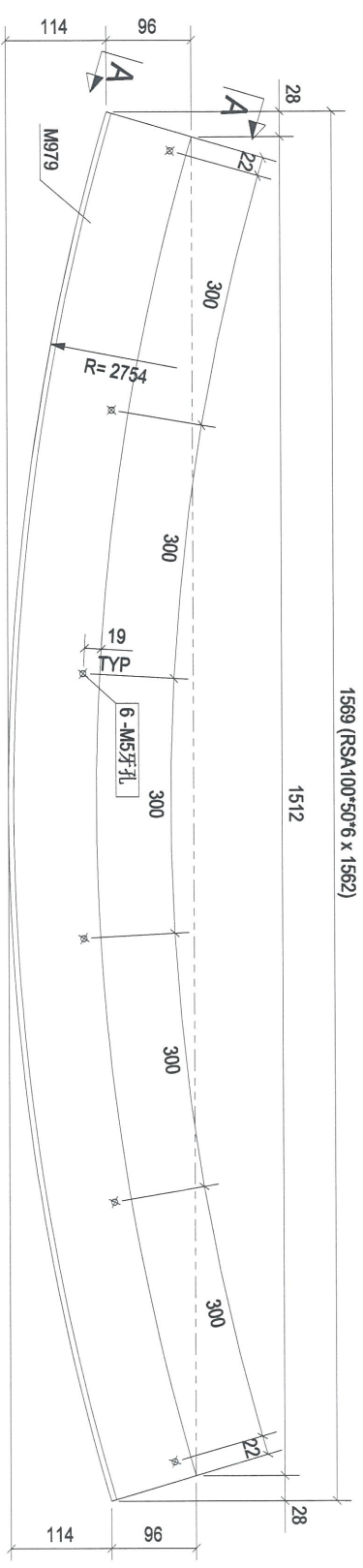

1569 (RSA100*50*6 x 1562)

1512

构件: 4JT-10

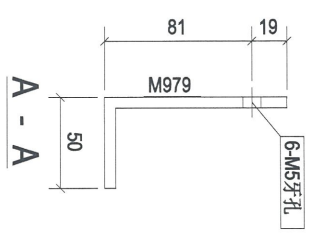

Rev.	Description	Date
0	第一次提批	2018-11-02

PROJECT: PROPOSED SITE C1 DEVELOPMENT AT AREA 88, TLOTL TO RP, TSEING KWAN O, NEW TERRITORIES

CLIENT: 美特铝业有限公司
M.T.L. Aluminium Fabrication Ltd.
Units 6 & 7, Samoj Industrial Centre, 1/F,
61D Chee Kwee Road, Kwai Tsing,
Tel: 23489211-4 Fax: (852) 27272656

银同有限公司
Silver Town Limited
Tel: 0753-83334988 Fax: 0753-83339954
E-Mail: Address: silvertown@163.com

DRAWING TITLE: [4JT-10]

CAD File Name :	
Designed by	
Drawn by	
Reviewed by	
Approved by	
Scale	
DWG NO. (MMW)-2 - [4JT-10]	REV. 0

40

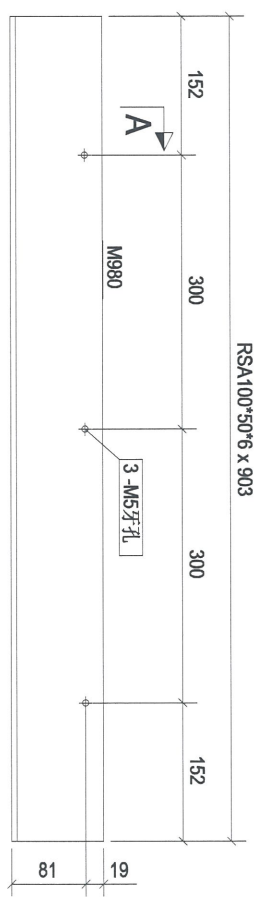

构件: 4JT-11

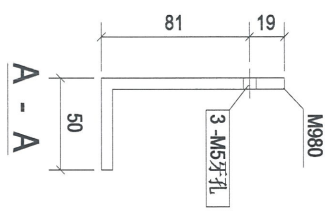

构件编号	4JT-11	构件数量	1	构件重量	6.13
部件编号	规格(mm)	长度(mm)	数量	单重(kg)	共重(kg)
M980	RSA100*50*6	903	1	6.13	6.13
合计:					6.13
				表面积(m ²)	0.27

Rev.	Description	Date
0	首次报批	2018-11-02

PROJECT: PROPOSED SITE C1
DEVELOPMENT AT AREA 86,
TKOIL 70 RP, TSEUNG KWAN O,
NEW TERRITORIES

CLIENT: 美特铝业有限公司
MIDI ALUMINIUM FABRICATOR LTD.
Units 6 & 8, Sunny Industrial Centre, 1/F
610 Chee Kwo Jung Road, Kowloon
Tel: 23499211-4 Fax: (852) 27278066

银同有限公司
Silver Town Limited
Tel: 0769-8339968 Fax: 0769-8339954
E-MAIL: ADDRESS@silvertown.hk; COW

DRAWING TITLE: [4JT-11]

CAD File Name :	
Designed by	
Drawn by	
Reviewed by	
Approved by	
Scale	
DWG NO.:	(MM4)-2 - [4JT-11]
REV	0

构件编号	4JT-12	构件数量	1	构件重量	5.65
部件编号	规格(mm)	长度(mm)	数量	单重(kg)	共重(kg)
M981	RSA100*50*6	833	1	5.65	5.65
合计:				5.65	0.25

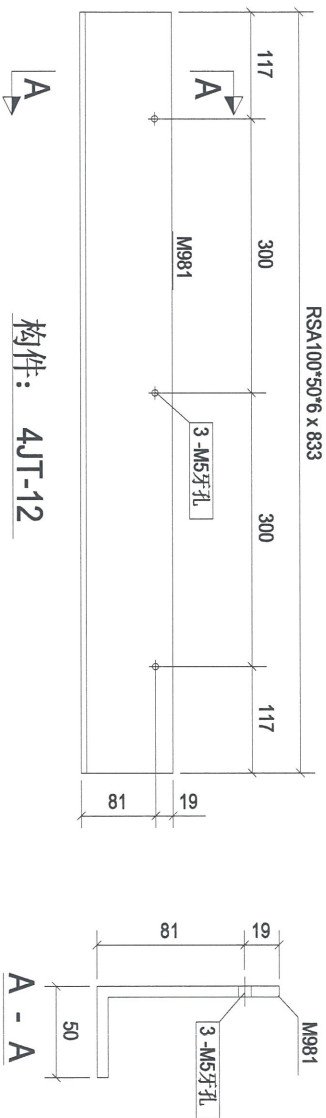

构件: 4JT-12



Rev.	Description	Date
0	第一次报批	2018-11-02

PROJECT: PROPOSED SITE C1
DEVELOPMENT AT AREA 86,
TKOIL 70 RP, TSEING KWAN O,
NEW TERRITORIES

CLIENT: 美特铝质有限公司
MIDD Aluminium Manufacturer Ltd.
Units 8-8, Sunny Industrial Centre, 1/F
670 Sze Kwo Tung Road, Kowloon
Tel: 23769211-4 Fax: (02) 2721056

银同有限公司
Silver Town Limited
Tel: 0769-83359468 Fax: 0769-83359564
E-MAIL: ADDRESS@silvertown.hk; S.T.COM

DRAWING TITLE :
[4JT-12]

CAD File Name :	
Designed by	
Drawn by	
Reviewed by	
Approved by	
Scale	
DWG NO. : (MM)4-2 - [4JT-12]	REV: 0

42

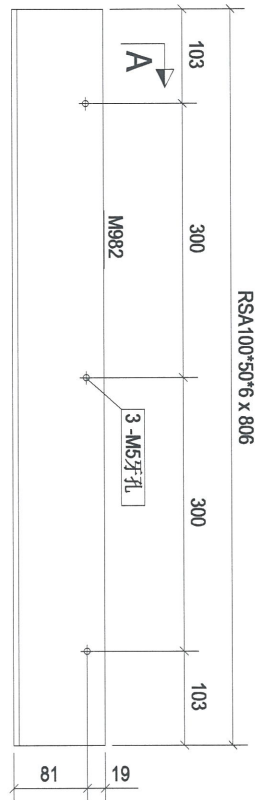

构件: 4JT-13

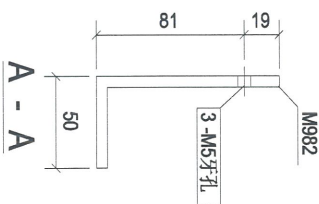

构件编号	4JT-13	构件数量	1	构件重量	5.47
部件编号	规格(mm)	长度(mm)	数量	单重(kg)	共重(kg)
M982	RSA100*50*6	806	1	5.47	5.47
					表面积(m ²)
					0.24
合计:				5.47	

Rev.	Description	Date
0	第一次报批	2018-11-02

PROJECT: PROPOSED SITE C1
DEVELOPMENT AT AREA 86,
TKOIL 70 HP, TSEUNG KWAN O,
NEW TERRITORIES

CLIENT: 美特铝业有限公司
M.T.I. Aluminium Fabricator Ltd.
Units 8 & 9, Sunny Industrial Centre, 1/F
610 Chee Keng Street, Kwai Tsing, N.T.
Tel: 2389211-4 Fax: (852) 2727566

Silver Town Limited
Tel: 078-8333488 Fax: 078-8333954
E-Mail: Address: silvertown@163.com

DRAWING TITLE: [4JT-13]

CAO File Name :	
Designed by	
Drawn by	
Reviewed by	
Approved by	
Scale	
DWG NO. (MM4)-2 - [4JT-13]	REV. 0

43

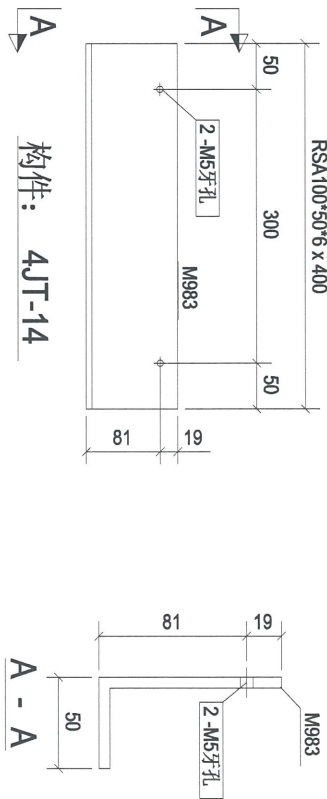

构件: 4JT-14

构件编号	4JT-14	构件数量	1	构件重量	2.72
部件编号	规格(mm)	长度(mm)	数量	单重(kg)	共重(kg)
M983	RSA100*50*6	400	1	2.72	2.72
合计:					2.72
				表面面积	0.12

Rev.	Description	Date
0	第一次报数	2018-11-02

PROJECT: PROPOSED SITE C1
DEVELOPMENT AT AREA 88,
TKOIL 70 RP, TSEUNG KWAN O,
NEW TERRITORIES

CLIENT: 美特铝有限公司
MIDI ALUMINIUM FABRICATOR LTD.
Units 6-8, Sunny Industrial Centre, 1/F,
610 Chee Kwo Ling Road, Kwai Tsong
Tel: 23989211-4 Fax: (852) 2727866

Silver Town Limited
Tel: 0769-83354988 Fax: 0769-83359954
E-MAIL: ADDRESS@silvertown.hk, CHINA

DRAWING TITLE: [4JT-14]

CAD File Name :

Designed by	
Drawn by	
Reviewed by	
Approved by	
Scale	

DWG NO.: (MMW)2 - [4JT-14]

REV	0
-----	---