

工程指示 / 要求簡箋(E.I.)

工程指示編號：EI/ 0030/19 修改版次：
 工程編號：J836 工程名稱：日出康城7期(平台)
 工程項目：E1 鐵件生產
 收件人：Maggie Lor 發件人：Joe Chan 日期：7/1/2019

要求提供 / 確認 事項：

- | | | |
|------------------------------------|-------------------------------------|-------------------------------|
| <input type="checkbox"/> 初步鋁料 B.M. | <input type="checkbox"/> 加工拆圖，然後生產 | <input type="checkbox"/> 尺寸表 |
| <input type="checkbox"/> 正式鋁料 B.M. | <input type="checkbox"/> 技術上資料 / 指示 | <input type="checkbox"/> 報價 |
| <input type="checkbox"/> 配件 B.M. | <input type="checkbox"/> 樣辦或貨品說明書 | <input type="checkbox"/> 分判合約 |
| <input type="checkbox"/> 其他：_____ | | |

內容：請依附件資料生產鐵件，完成生產
 後按地盤指示送地盤。
 驗焊：20% 磁粉，100% 目測。

請在 28/2/2019 前完成上列要求。

附有關圖紙 / 文件：

134 頁

以上項目為：

- 原合約工程包 原合約工程加 / 減賬 新工程報價

原因：-

分發東莞各部門：

- () 生產技術總監 連附件 () 技術部 連附件 () 生產部 連附件 () 機械設計部 連附件
 () 採購部 連附件 () 生產統籌部 連附件
 () 質檢部 連附件 () 會計部 連附件 () 報關組 連附件 () 其他 王禮秋 連附件

分發香港各部門：

- () 行政部 連附件 () 會計部 連附件 () 統籌部 連附件 () 工程地盤科 連附件 積哥
 () 採購部 連附件 () QS 部 連附件 () 維修部 連附件 () 其他 _____ 連附件

傳遞編號：

發件人簽署：

項目經理簽署：

①

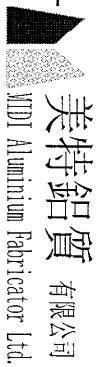

美特鋁質有限公司	工程號: J-836	計算:	日期: 05/01/2019	送呈:
MDT Aluminium Fabricator Ltd.	地盤名稱: 日出康城7期	核對:	日期: 05/01/2019	副本:

地盤鐵件BM表	項目類別:	批准:	日期:
---------	-------	-----	-----

BM編號:	修改版次:	A/C Code:	鐵件總重量KG:	9358.20
-------	-------	-----------	----------	---------

序號	修改內容	鐵件圖號	鐵件名稱	顏色	實用	後備	總數	單位	單件 (kg)	總重量 (kg)	備注
1		BLC-1	75*60*5mm鐵槽	熱浸鋅	1	0	1	件	9.500	9.500	
2		BLC-2	50*40*5mm鐵槽	熱浸鋅	1	0	1	件	19.900	19.900	
3		BLC-3	60*45*5mm鐵槽	熱浸鋅	1	0	1	件	11.200	11.200	
4		BLC-4	60*45*5mm鐵槽	熱浸鋅	1	0	1	件	8.000	8.000	
5		BLC-5	60*45*5mm鐵槽	熱浸鋅	1	0	1	件	10.400	10.400	
6		BLC-6	60*45*5mm鐵槽	熱浸鋅	1	0	1	件	10.400	10.400	
7		BLC-7	40*40*5mm鐵槽	熱浸鋅	2	0	2	件	4.100	8.200	
8		BLC-8	40*40*5mm鐵槽	熱浸鋅	2	0	2	件	4.200	8.400	
9		BLC-9	60*50*5mm鐵槽	熱浸鋅	1	0	1	件	7.100	7.100	
10		BLC-10	60*60*5mm鐵槽	熱浸鋅	1	0	1	件	13.600	13.600	
11		BLC-11	60*60*5mm鐵槽	熱浸鋅	1	0	1	件	12.700	12.700	
12		BLC-12	60*60*5mm鐵槽	熱浸鋅	1	0	1	件	9.800	9.800	
13		BLC-13	60*60*5mm鐵槽	熱浸鋅	1	0	1	件	12.700	12.700	
14		BLC-14	70*40*5mm鐵槽	熱浸鋅	2	0	2	件	9.900	19.800	
15		BLC-15	80*67*5mm鐵槽	熱浸鋅	4	0	4	件	2.400	9.600	
16		BLC-16	50*50*5mm鐵槽	熱浸鋅	1	0	1	件	9.900	9.900	
17		BLC-17	80*45*5mm鐵槽	熱浸鋅	4	0	4	件	1.875	7.500	
18		BLC-18	70*40*5mm鐵槽	熱浸鋅	1	0	1	件	9.600	9.600	
19		BLC-19	65*60*5mm鐵槽	熱浸鋅	3	0	3	件	12.000	36.000	

2

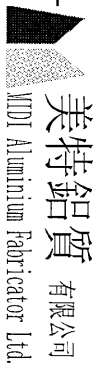

美特鋁質有限公司
MIDI Aluminium Fabricator Ltd

工程號: J-836

計算:

日期:

05/01/2019

送呈:

地盤名稱: 日出康城7期

核對:

日期:

05/01/2019

副本:

地盤鐵件BM表

項目類別:

批准:

日期:

BM編號:

修改版次:

A/C Code:

鐵件總重量KG: 9358.20

序號	修改內容	鐵件圖號	鐵件名稱	顏色	實用	後備	總數	單位	單件 (kg)	總重量 (kg)	備注
20		BLC-20	65*60*5mm鐵槽	熱浸鋅	1	0	1	件	11.600	11.600	
21		BLC-21	65*60*5mm鐵槽	熱浸鋅	1	0	1	件	8.300	8.300	
22		BLC-22	60*40*5mm鐵槽	熱浸鋅	1	0	1	件	5.500	5.500	
23		BLC-23	70*40*5mm鐵槽	熱浸鋅	1	0	1	件	9.300	9.300	
24		BLC-24	70*40*5mm鐵槽	熱浸鋅	1	0	1	件	6.600	6.600	
25		BLC-25	60*40*5mm鐵槽	熱浸鋅	1	0	1	件	5.500	5.500	
26		ESJ-1	50*50*5mm角鐵	熱浸鋅	20	0	20	件	0.455	9.100	
27		ESJ-2	125*75*7mm角鐵	熱浸鋅	12	0	12	件	1.592	19.100	
28		ESJ-3	80*50*8mm角鐵	熱浸鋅	14	0	14	件	1.150	16.100	
29		ESJ-4	65*50*6mm角鐵	熱浸鋅	4	0	4	件	0.525	2.100	
30		ESJ-5	50*50*5mm方通	熱浸鋅	1	0	1	件	12.000	12.000	
31		ESJ-6	50*50*5mm方通	熱浸鋅	3	0	3	件	12.800	38.400	
32		ESJ-7	50*50*5mm方通	熱浸鋅	1	0	1	件	9.200	9.200	
33		ESJ-8	150*150*10mm角鐵	熱浸鋅	1	0	1	件	8.100	8.100	
34		ESJ-9	25*25*3mm角鐵	熱浸鋅	3	0	3	件	1.900	5.700	
35		ESJ-10	25*25*3mm角鐵	熱浸鋅	1	0	1	件	1.900	1.900	
36		ESJ-11	25*25*3mm角鐵	熱浸鋅	1	0	1	件	1.300	1.300	
37		ESJ-12	65*65*6mm角鐵	熱浸鋅	16	0	16	件	0.581	9.300	
38		ESJ-13	100*100*6mm角鐵	熱浸鋅	12	0	12	件	0.917	11.000	

3

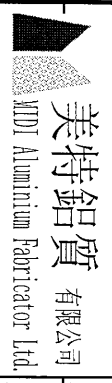

美特鋁質有限公司 MDT Aluminium Fabricator Ltd.	工程號: J-836	計算:	日期: 05/01/2019	送呈:
地盤名稱: 日出康城7期	核對:	日期: 05/01/2019	副本:	

地盤鐵件BM表	項目類別:	批准:	日期:
---------	-------	-----	-----

BM編號:	修改版次:	A/C Code:	鐵件總重量KG:
			9358.20

序號	修改內容	鐵件圖號	鐵件名稱	顏色	實用	後備	總數	單位	單件 (kg)	總重量 (kg)	備註
39		ESJ-14	15*140.5mm鐵板	熱浸鋅	2	0	2	件	2.850	5.700	
40		ESJ-15	15*150mm鐵板	熱浸鋅	2	0	2	件	6.900	13.800	
41		ESJ-16	4*100mm鐵板	熱浸鋅	6	0	6	件	0.317	1.900	
42		ESJ-17	12*350mm鐵板	熱浸鋅	2	0	2	件	18.100	36.200	
43		ESJ-18	12*270mm鐵板	熱浸鋅	3	0	3	件	6.900	20.700	
44		ESJ-19	12*220mm鐵板	熱浸鋅	9	0	9	件	5.600	50.400	
45		ESJ-20	75*50*5mm角鐵	熱浸鋅	8	0	8	件	0.475	3.800	
46		ESJ-21	50*50*5mm角鐵	熱浸鋅	24	0	24	件	0.379	9.100	
47		ESJ-22	50*50*5mm方通	熱浸鋅	6	0	6	件	2.400	14.400	
48		ESJ-23	50*50*5mm方通	熱浸鋅	6	0	6	件	0.500	3.000	
49		ESJ-24	8*125mm鐵板	熱浸鋅	1	0	1	件	1.700	1.700	
50		ESJ-25	8*125mm鐵板	熱浸鋅	1	0	1	件	1.900	1.900	
51		ESJ-26	8*125mm鐵板	熱浸鋅	1	0	1	件	1.500	1.500	
52		ESJ-27	8*125mm鐵板	熱浸鋅	1	0	1	件	1.300	1.300	
53		ESJ-28	8*125mm鐵板	熱浸鋅	1	0	1	件	1.800	1.800	
54		ESJ-29	8*125mm鐵板	熱浸鋅	1	0	1	件	1.700	1.700	
55		ESJ-30	8*125mm鐵板	熱浸鋅	1	0	1	件	2.100	2.100	
56		ESJ-31	8*125mm鐵板	熱浸鋅	1	0	1	件	2.100	2.100	
57		ESJ-32	75*75*6mm角鐵	熱浸鋅	3	0	3	件	11.900	35.700	

4

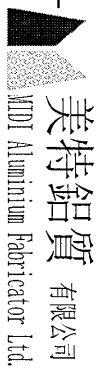

美特鋁質有限公司
MTDI Aluminium Fabricator Ltd.

工程號: J-836
地盤名稱: 日出康城7期

計算:
核對:

日期: 05/01/2019
日期: 05/01/2019

送呈:
副本:

地盤鐵件BM表

項目類別:

批准:

日期:

BM編號:

修改版次:

A/C Code:

鐵件總重量KG:

9358.20

序號	修改內容	鐵件圖號	鐵件名稱	顏色	實用	後備	總數	單位	單件 (kg)	總重量 (kg)	備注
58		ESJ-33	75*75*6mm角鐵	熱浸鋅	1	0	1	件	11.500	11.500	
59		ESJ-34	40*40*4mm角鐵	熱浸鋅	28	0	28	件	0.243	6.800	
60		ESJ-35	75*75*6mm角鐵	熱浸鋅	1	0	1	件	8.200	8.200	
61		ESJ-36	65*50*5mm角鐵	熱浸鋅	12	0	12	件	0.433	5.200	
62		ESJ-37	65*50*5mm角鐵	熱浸鋅	3	0	3	件	0.433	1.300	
63		ESJ-38	65*50*5mm角鐵	熱浸鋅	24	0	24	件	0.438	10.500	
64		ESJ-39	40*40*4mm角鐵	熱浸鋅	8	0	8	件	0.113	0.900	
65		ESJ-40	50*50*5mm角鐵	熱浸鋅	13	0	13	件	0.377	4.900	
66		ESJ-41	50*50*5mm角鐵	熱浸鋅	12	0	12	件	0.500	6.000	
67		ESJ-42	40*40*4mm角鐵	熱浸鋅	36	0	36	件	0.172	6.200	
68		ESJ-43	75*75*6mm角鐵	熱浸鋅	3	0	3	件	0.667	2.000	
69		JT-1	50*50*4mm角鐵	熱浸鋅	20	0	20	件	9.080	181.600	
70		JT-8	100*45*5mm角鐵	熱浸鋅	1	0	1	件	21.400	21.400	
71		JT-9	100*45*5mm角鐵	熱浸鋅	1	0	1	件	7.800	7.800	
72		JT-10	100*45*5mm角鐵	熱浸鋅	1	0	1	件	11.200	11.200	
73		JT-11	40*40*4mm角鐵	熱浸鋅	16	0	16	件	0.725	11.600	
74		JT-12	75*50*5mm角鐵	熱浸鋅	1	0	1	件	8.200	8.200	
75		JT-13	75*50*5mm角鐵	熱浸鋅	1	0	1	件	8.000	8.000	
76		JT-14	75*50*5mm角鐵	熱浸鋅	1	0	1	件	41.600	41.600	

5



美特鋁質有限公司 MIDI Aluminium Fabricator Ltd.	工程號: 1-836	計算:	日期: 05/01/2019	送呈:
地盤名稱: 日出康城7期	核對:	日期: 05/01/2019	副本:	

地盤鐵件BM表	項目類別:	批准:	日期:
BM編號:	修改版次:	A/C Code:	鐵件總重量KG:

序號	修改內容	鐵件圖號	鐵件名稱	顏色	實用	後備	總數	單位	單件 (kg)	總重量 (kg)	備注
77		P5	5*40mm鐵板	熱浸鋅	24	0	24	件	0.063	1.500	
78		P6	4*40mm鐵板	熱浸鋅	24	0	24	件	0.050	1.200	
79		P7	12*232.8mm鐵板	熱浸鋅	20	0	20	件	5.180	103.600	
80		R1-1	250*150*12mm扁通	熱浸鋅	1	0	1	件	284.200	284.200	
81		R1-2	250*150*12mm扁通	熱浸鋅	1	0	1	件	284.200	284.200	
82		R1-3	250*150*12mm扁通	熱浸鋅	4	0	4	件	284.225	1136.900	
83		R2-1	150*100*6mm扁通	熱浸鋅	2	0	2	件	37.600	75.200	
84		R2-1	150*100*6mm扁通	熱浸鋅	1	0	1	件	37.600	37.600	
85		R2-3	150*100*6mm扁通	熱浸鋅	1	0	1	件	36.400	36.400	
86		R2-4	150*100*6mm扁通	熱浸鋅	3	0	3	件	37.600	112.800	
87		R2-5	150*100*6mm扁通	熱浸鋅	1	0	1	件	37.600	37.600	
88		R2-6	150*100*6mm扁通	熱浸鋅	1	0	1	件	25.500	25.500	
89		R2-7	150*100*6mm扁通	熱浸鋅	1	0	1	件	25.500	25.500	
90		R2-8	150*100*6mm扁通	熱浸鋅	1	0	1	件	35.700	35.700	
91		R3-1	150*100*10mm扁通	熱浸鋅	4	0	4	件	150.575	602.300	
92		R3-2	150*100*10mm扁通	熱浸鋅	1	0	1	件	56.800	56.800	
93		R3-3	150*100*10mm扁通	熱浸鋅	1	0	1	件	98.600	98.600	
94		R3-4	150*100*10mm扁通	熱浸鋅	1	0	1	件	102.600	102.600	
95		R3-5	150*100*10mm扁通	熱浸鋅	1	0	1	件	104.100	104.100	

6

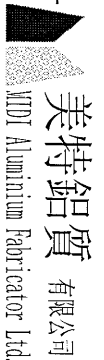

美特鋁質有限公司	工程號: J-836	計算:	日期: 05/01/2019	送呈:
MDT Aluminium Fabricator Ltd	地盤名稱: 日出康城7期	核對:	日期: 05/01/2019	副本:

地盤鐵件BM表	項目類別:	批准:	日期:
---------	-------	-----	-----

BM編號:	修改版次:	A/C Code:	鐵件總重量KG:	9358.20
-------	-------	-----------	----------	---------

序號	修改內容	鐵件圖號	鐵件名稱	顏色	實用	後備	總數	單位	單件 (kg)	總重量 (kg)	備注
96		R3-6	150*100*10mm扁通	熱浸鋅	1	0	1	件	98.200	98.200	
97		R3-7	150*100*10mm扁通	熱浸鋅	1	0	1	件	56.700	56.700	
98		R3-8	150*100*10mm扁通	熱浸鋅	2	0	2	件	151.300	302.600	
99		R3-9	150*100*10mm扁通	熱浸鋅	1	0	1	件	88.500	88.500	
100		R3-10	150*100*10mm扁通	熱浸鋅	1	0	1	件	104.400	104.400	
101		R3-11	150*100*10mm扁通	熱浸鋅	1	0	1	件	101.700	101.700	
102		R4-1	200*150*12mm角鐵	熱浸鋅	1	0	1	件	115.900	115.900	
103		R5-1	120*80*5mm扁通	熱浸鋅	1	0	1	件	17.700	17.700	
104		R5-2	120*80*5mm扁通	熱浸鋅	3	0	3	件	25.700	77.100	
105		R5-3	120*80*5mm扁通	熱浸鋅	1	0	1	件	23.800	23.800	
106		R5-4	100*50*5mm扁通	熱浸鋅	2	0	2	件	27.800	55.600	
107		R6-1	100*100*5mm扁通	熱浸鋅	2	0	2	件	27.850	55.700	
108		R6-2	100*100*5mm扁通	熱浸鋅	4	0	4	件	27.900	111.600	
109		S1-1	500*300*16mm扁通	熱浸鋅	1	0	1	件	2114.700	2114.700	
110		S2-1	200*200*10mm扁通	熱浸鋅	1	0	1	件	450.900	450.900	
111		S3-1	150*150*10mm扁通	熱浸鋅	1	0	1	件	51.900	51.900	
112		S3-2	150*150*10mm扁通	熱浸鋅	1	0	1	件	75.500	75.500	
113		S3-3	150*150*10mm扁通	熱浸鋅	1	0	1	件	80.100	80.100	
114		S4-1	150*150*10mm扁通	熱浸鋅	1	0	1	件	168.000	168.000	

7

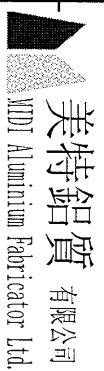

美特鋁質有限公司
MDI Aluminium Fabricator Ltd.

工程號: J-836

計算:

日期: 05/01/2019

送呈:

地盤名稱: 日出康城7期

核對:

日期: 05/01/2019

副本:

地盤鐵件BM表

項目類別:

批准:

日期:

BM編號: 修改版次:

A/C Code:

鐵件總重量KG: 9358.20

序號	修改內容	鐵件圖號	鐵件名稱	顏色	實用	後備	總數	單位	單件 (kg)	總重量 (kg)	備注
115		S4-2	150*150*10mm扁通	熱浸鋅	1	0	1	件	65.100	65.100	
116		S4-3	150*150*10mm扁通	熱浸鋅	1	0	1	件	88.100	88.100	
117		S7-1	40*40*4mm角鐵	熱浸鋅	3	0	3	件	4.200	12.600	
118		S7-2	40*40*4mm角鐵	熱浸鋅	1	0	1	件	4.100	4.100	
119		S7-3	40*40*4mm角鐵	熱浸鋅	1	0	1	件	2.900	2.900	
120		TB-1	30*300mm鐵板	熱浸鋅	1	0	1	件	90.200	90.200	
121		TB-2	30*300mm鐵板	熱浸鋅	2	0	2	件	49.700	99.400	
122		TB-3	30*300mm鐵板	熱浸鋅	7	0	7	件	69.800	488.600	
123		TB-4	30*300mm鐵板	熱浸鋅	1	0	1	件	206.200	206.200	
					合計:		525	件	合共:	9358.200	

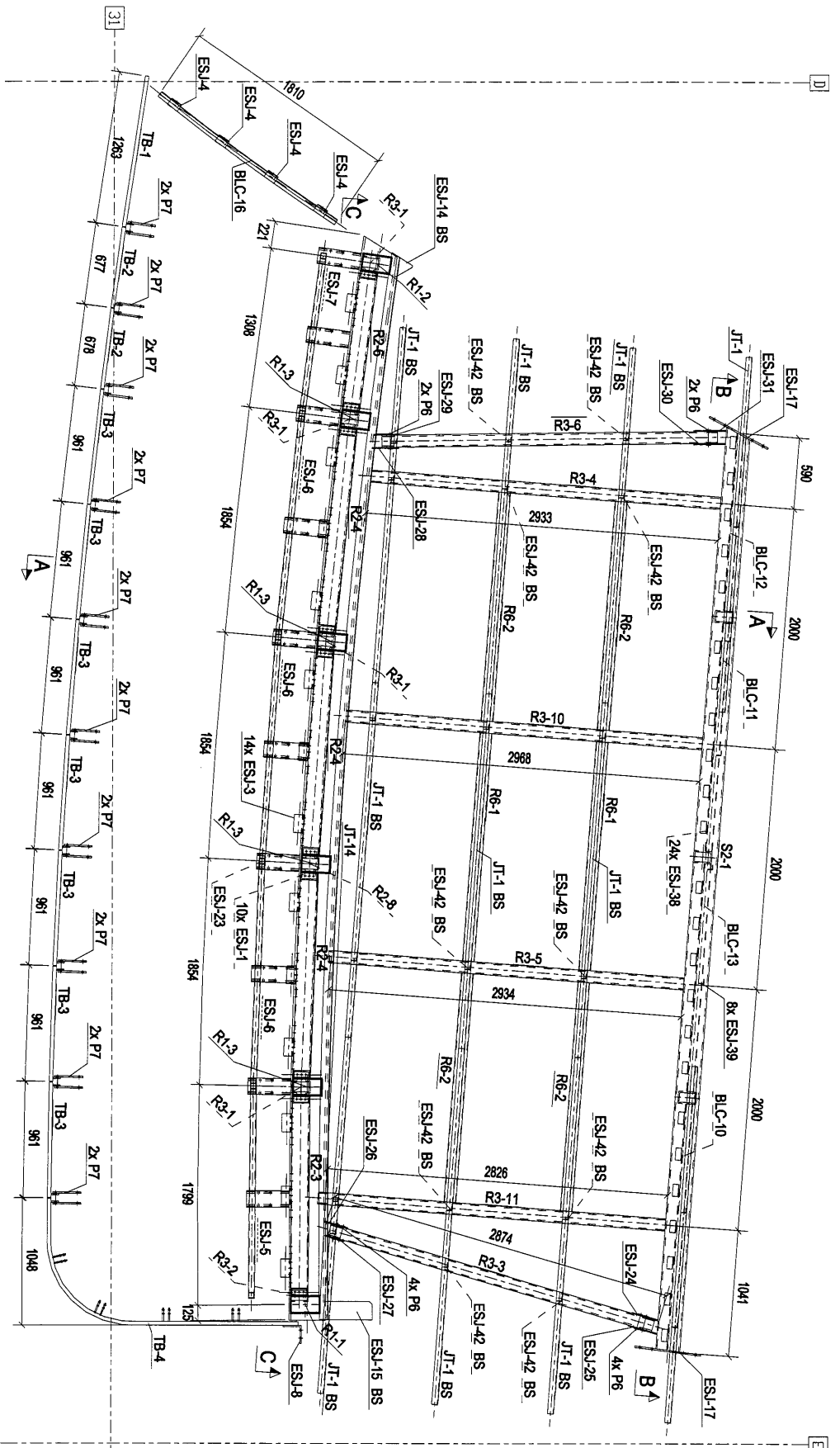

PART PLAN FOR WINDOW WALL AND CANOPY AT E1 ENTRANCE

(B)

REV	Description	Date
A	第一次批准	2019-01-05

PROJECT: PROPOSED SITE C1 DEVELOPMENT IN AREA B8, TAOLOI/TAI TSEUNG KWAN/NO. NEW TERRITORIES

CLIENT: 榮特鋸實有限公司
 MIDJI Aluminium Fabrication Ltd.
 Units 6-8, Sunny Industrial Centre, 1/F,
 510 Chee Kwo Ling Road, Kamlong
 Tel: (852) 489211-4 Fax: (852) 72727666

MARKING PLAN

Designed by	
Drawn by	
Reviewed by	
Approved by	
Scale	
DWGNO.: E1	- MP01
REV	A

9

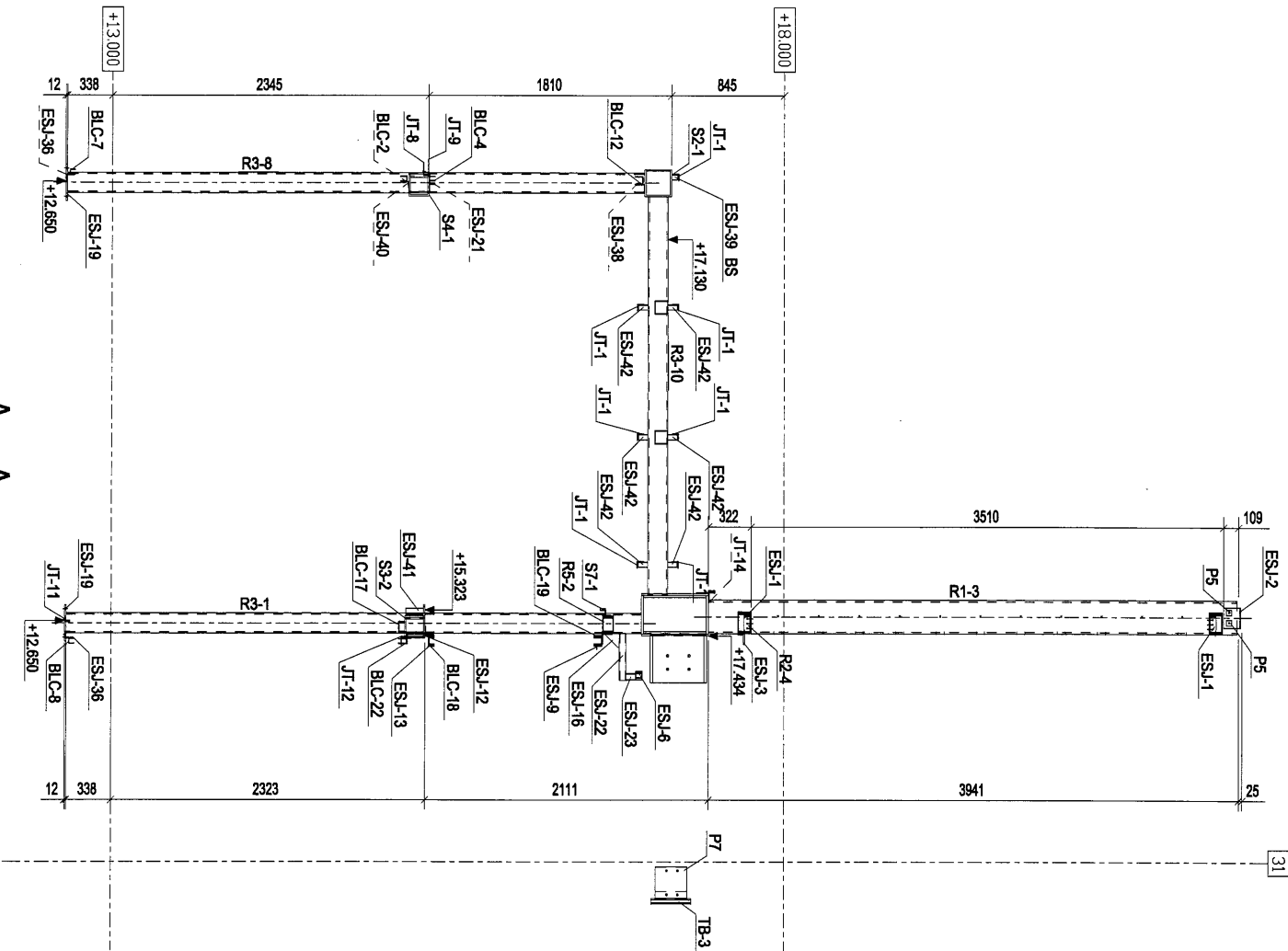

A - A

Rev.	Description	Date
A	第2次校核	2019-01-05

PROJECT:
 PROPOSED SITE C1
 DEVELOPMENT AT AREA A6,
 TROTU TO P'P TSEUNG KWAN O,
 NEW TERRITORIES

CLIENT:
 美特經貿有限公司
 MIDT Automotive Associates Ltd.
 Units 6-8, Sunray Industrial Centre, 1/F,
 610 Chee Kwo Ling Road, Kowloon
 Tel: 23489211-4 Fax: (852) 27275665

 中國石油有限公司
 Sinochem (China) Limited

MARKING PLAN

Designed by	
Drawn by	
Reviewed by	
Approved by	
Scale	
DWG NO.:	E1 - MP02
REV	A

10

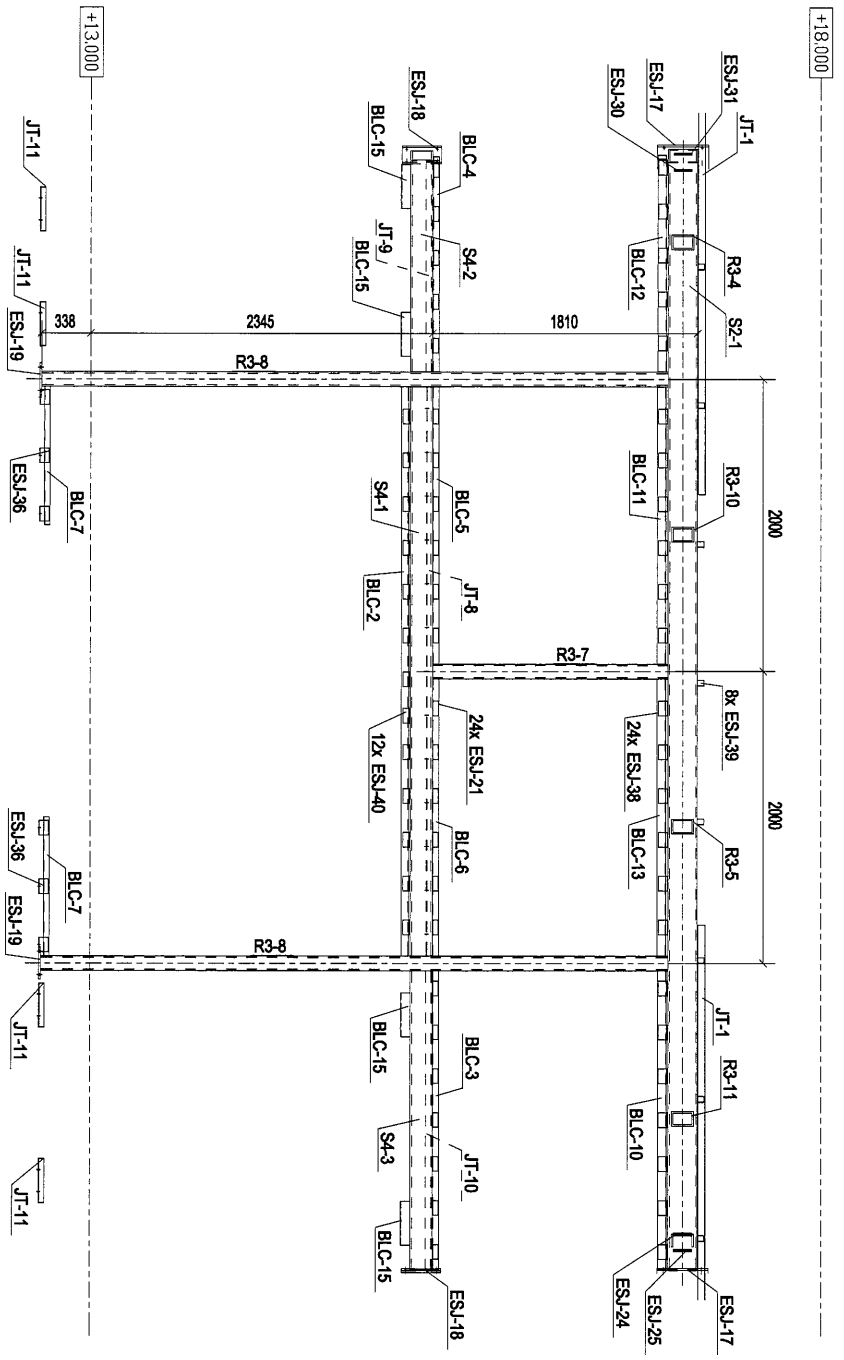

Rev.	Description	Date
A	第一次校核	2019-01-05

PROJECT: PROPOSED SITE C1
DEVELOPMENT AT AREAS
TKOT1 TO TP TSEUNG KWAN O,
NEW TERRITORIES

CLIENT: 美特經貿有限公司
MIDI AUSTRALIA INVESTMENT LTD.
Units 6-8, Sunray Industrial Centre, 1/F
510 Che Kwo Ling Road, Kowloon
Tel: 23489211-4 Fax: (852) 27272656



MARKING PLAN

Designed by	
Drawn by	
Reviewed by	
Approved by	
Scale	
DWG NO.:	E1 - MP03
REV	A

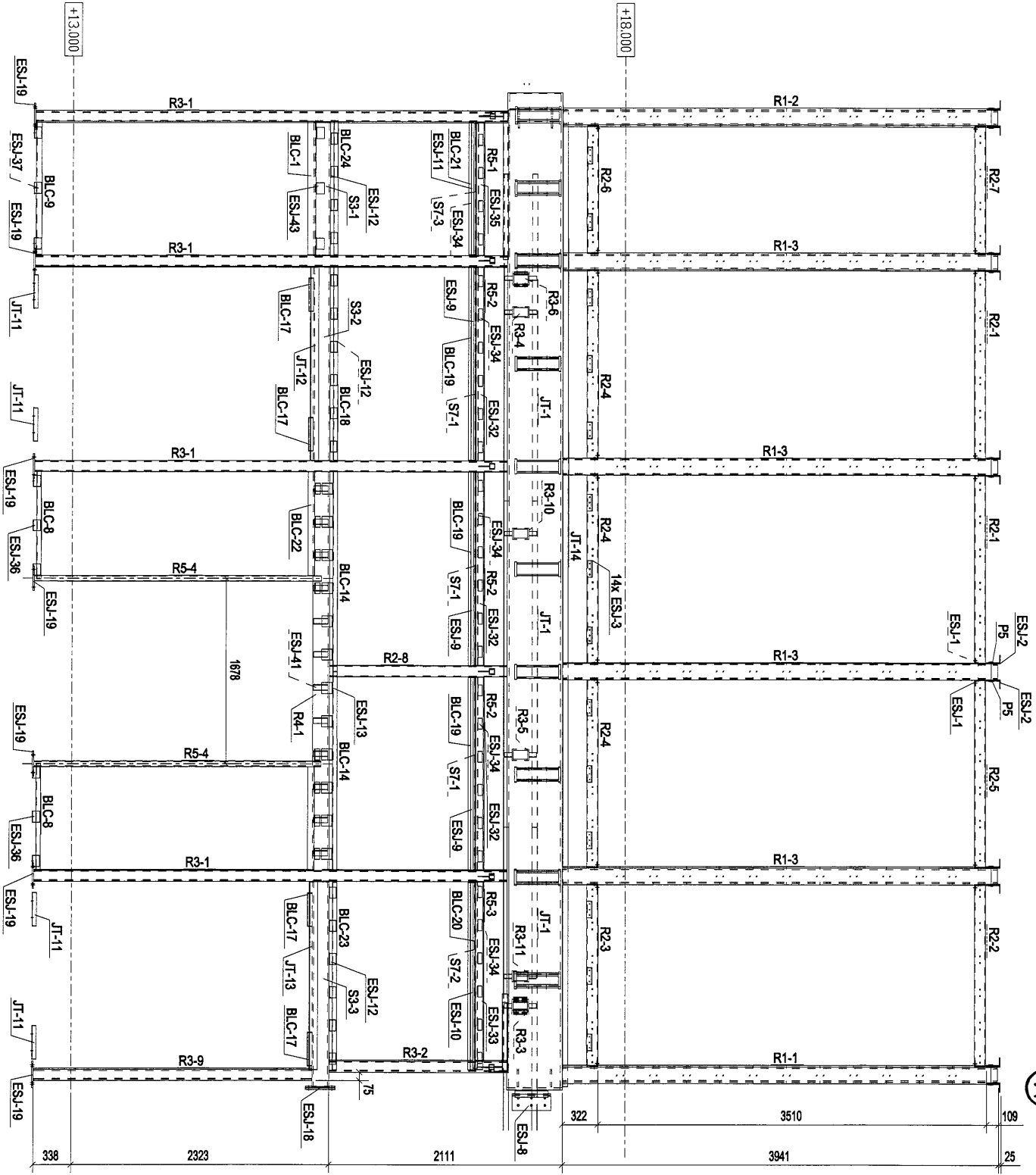

C - C

11

Rev.	Description	Date
A	第一次提批	2019-01-05

PROJECT: PROPOSED SITE C1 DEVELOPMENT AT AREA B6, TKOIT TO FP TSEUNG KWAN O, NEW TERRACES

CLIENT: 美特經貿有限公司
 MIDT Aluminium Industries Ltd.
 Units 5-8, Sunny Industrial Centre, 7/F
 610 Che Kwo Ling Road, Kowloon
 Tel: 23489211-4 Fax: (852) 27272656



MARKING PLAN

Designed by	
Drawn by	
Reviewed by	
Approved by	
Scale	
DWG NO: E1	- MP04
REV	A

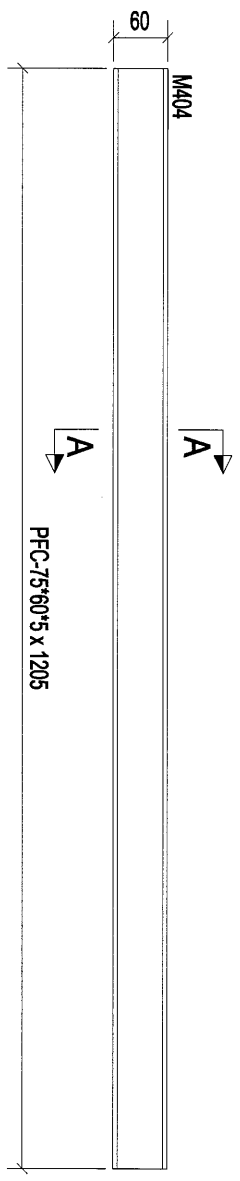

构件: BLC-1

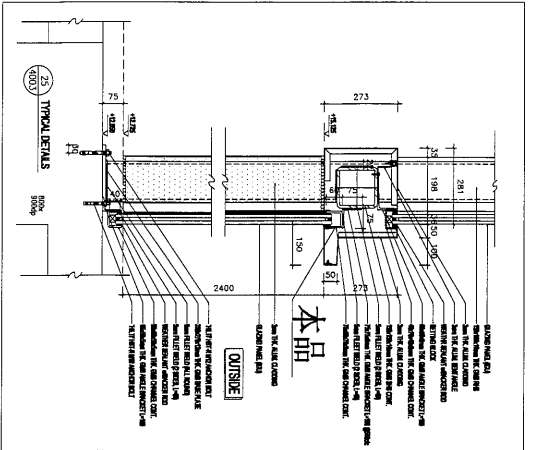
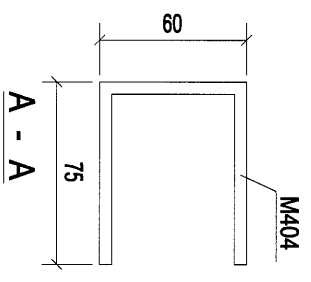

构件编号	规格(mm)	长度(mm)	数量	单重(kg)	共重(kg)	表面积(m ²)
M404	PFC-75*60*5	1205	1	9.46	9.46	0.50
合计:				9.46		

Rev.	Description	Date
0	第一次报批	2019-01-05

PROJECT: PROPOSED SITE C1 DEVELOPMENT AT AREA A8, TQOTL TOPP TSEUNG KWANLO, NEW TERRITORIES

CLIENT: 基特銘實有限公司
MIDI Aluminium Associates Ltd.
Units 6-8, Sunng Industrial Centre, 1/F
610 Chin Kwo Ling Road, Kwailoon
Tel: (852) 98211-4 Fax: (852) 7727666

維尼有限公司
VINI CO., LTD.

[BLC-1]

Designed by	
Drawn by	
Reviewed by	
Approved by	
Scale	
DWGNO.: E1	- [BLC-1]
REV.	0

14

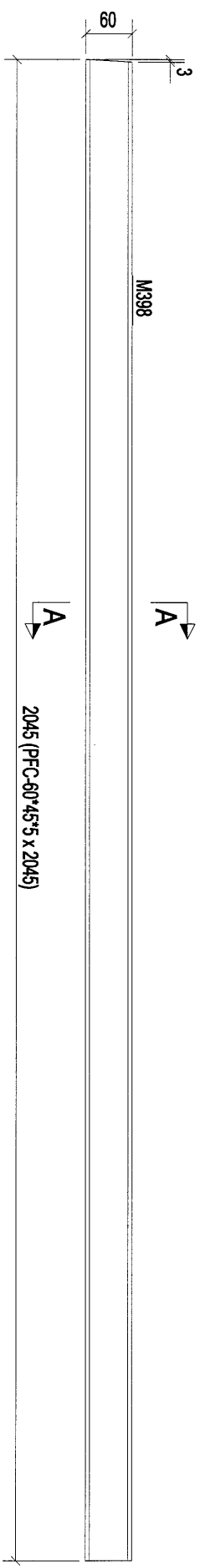

构件: BLC-3

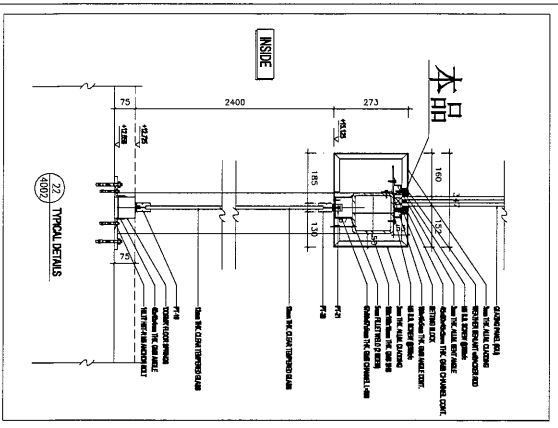
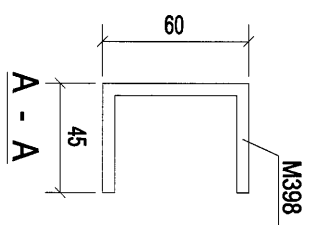

构件编号: BLC-3		构件数量: 1		构件重量: 11.23	
部件编号	规格(mm)	长度(mm)	数量	单重(kg)	共重(kg)
M398	PFC-60*45*5	2045	1	11.23	11.23
					表面积(m ²)
					0.59
合计:					11.23

Rev	Description	Date
0	第一次报批	2019-01-05

PROJECT: PROPOSED SITE C1 DEVELOPMENT AT AREA 8, TOLTEC/TPP TSEUNG KWAN HO, NEW TERRITORIES

CLIENT: 美特鋁質有限公司
MIDI ALUMINUM PRODUCTS LTD.
Units 6-8, Sunny Industrial Centre, 1/F
610 Chi Kwo Ling Road, Kowloon
Tel: 23489211-4 Fax: (852) 27727666

美特鋁質有限公司
MIDI ALUMINUM PRODUCTS LTD.

[BLC-3]

Designed by	
Drawn by	
Reviewed by	
Approved by	
Scale	
DWG NO: E1	- [BLC-3]
REV	0

15

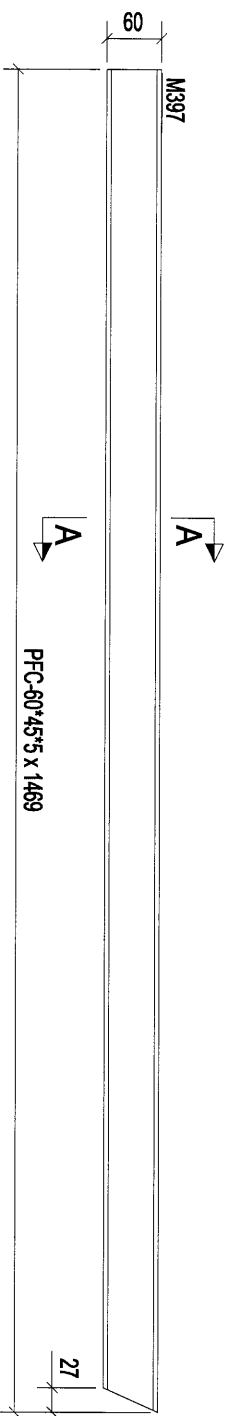

PFC-60*45*5 x 1469

构件: BLC-4

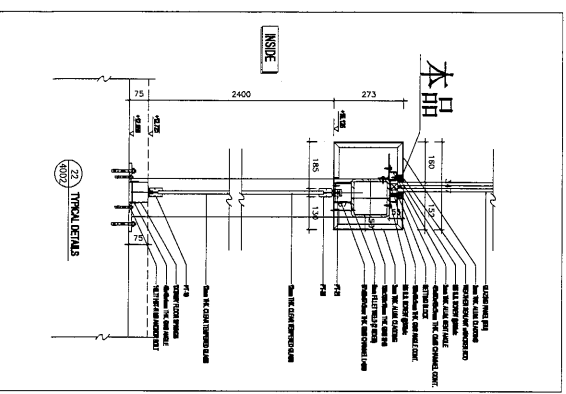
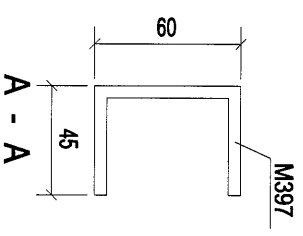

构件编号: BLC-4		构件数量: 1		构件重量: 8.00	
部件编号	规格(mm)	长度(mm)	数量	单重(kg)	共重(kg)
M397	PFC-60*45*5	1469	1	8.00	8.00
					表面积(m²)
					0.42

合计: 8.00

Rev.	Description	Date
0	第一次报批	2019-01-05

PROJECT:
PROPOSED SITE C1
DEVELOPMENT AT AREA 08,
TJOT/TJOP, TSEUNG KWAN HO,
NEW TERRITORIES

CLIENT:
基特鋁質有限公司
MIDI Aluminium Associates Ltd.
Units 6-8, Sunng Industrial Centre, 1/F,
610 Chin Kwo Ling Road, Kowloon
Tel: 23482711-4 Fax: (852) 27276666



MIDI Aluminum Associates Ltd.
維昌石隆公司
11111111111111111111

[BLC-4]

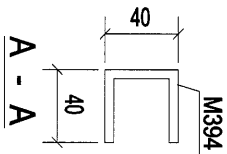
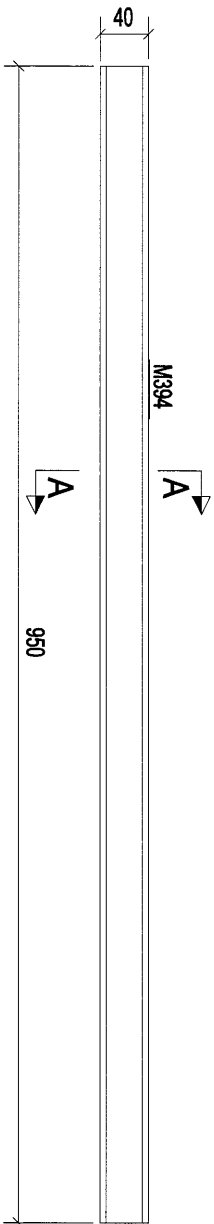
Designed by	
Drawn by	
Reviewed by	
Approved by	
Scale	
DMG NO.: E1	- [BLC-4]
REV	0

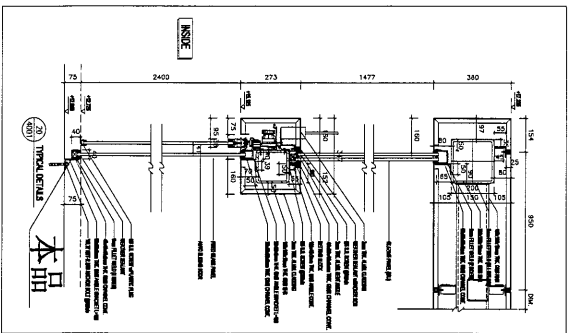

构件: BLC-7



18

Rev.	A	第2次报批	2019-01-05
		Description	Date

PROJECT:
PROPOSED SITE C1 DEVELOPMENT AT AREA A8, TQOT 70 RP TSEUNG KWAN O, NEW TERRITORIES

CLIENT:
美特經貿有限公司
MIDI AUTOMATIC MACHINERY LTD.
 Units 6-8, Sunny Industrial Centre, 1/F
 610 Chee Kwo Ling Road, Kwunloon
 Tel: 23469211-4 Fax: (852) 27276665

捷昇工程有限公司
G.P. ENGINEERING LIMITED

[BLC-7]

Designed by	
Drawn by	
Reviewed by	
Approved by	
Scale	
DWG NO.: E1	- [BLC-7]
REV	A

构件编号:	BLC-7	构件数量:	2	构件重量:	4.10
规格(mm)	PFC-40*40*5	长度(mm)	950	数量	1
		重量	4.10	表面积(m ²)	0.22
M394		合计:	4.10		

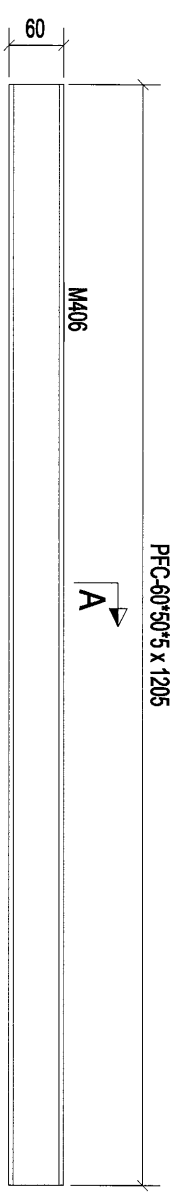

构件: BLC-9

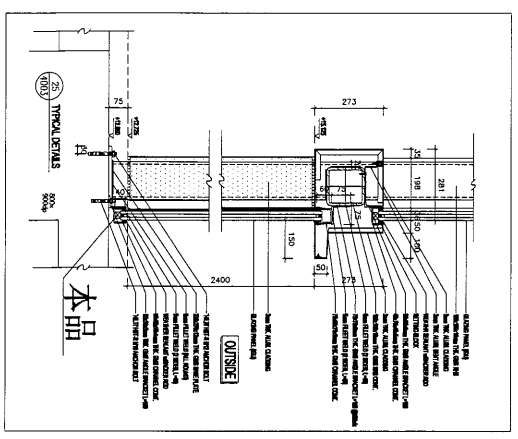
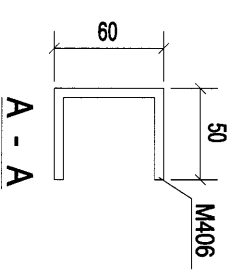

构件编号:	BLC-9	构件数量:	1	构件重量:	7.09
部件编号	规格(mm)	长度(mm)	数量	单重(kg)	共重(kg)
M406	PFC-60*50*5	1205	1	7.09	7.09
合计:				7.09	0.38

Rev.	Revision	Date
A	第一次设计	2019-01-05

PROJECT: PROPOSED SITE C1
DEVELOPMENT AT AREA A8,
TLOT 10/PP TSEUNG KWAN O,
NEW TERRITORIES

CLIENT: 美特经贸有限公司
MIDI AUTOMOTIVE ASSOCIATES LTD.
Units 6-8, Sunny Industrial Centre, 1/F,
610 Che Kwo Ling Road, Kowloon
Tel: 23489211-4 Fax: (852) 27278566

住友商事株式会社
Mitsui Inhabo Co., Ltd.

[BLC-9]

Designed by	
Drawn by	
Reviewed by	
Approved by	
Scale	
DWG NO: E1	- [BLC-9]
REV	A

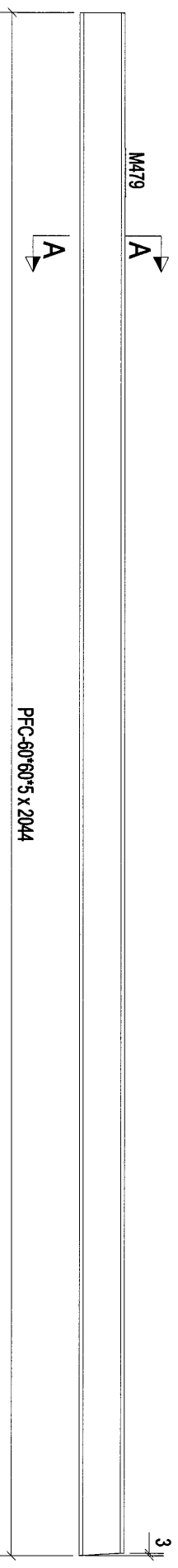

PFC-60*60*5 x 2044

构件: BLC-10

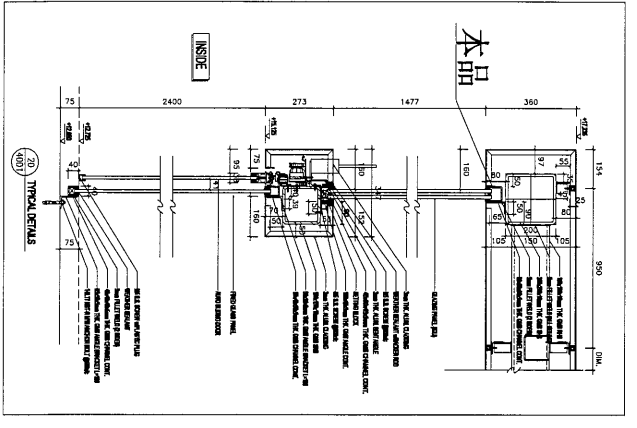
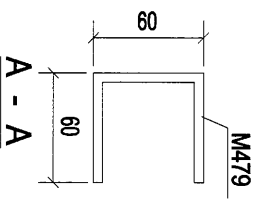

构件编号:	BLC-10	构件数量:	1	构件重量:	13.62
部件编号	规格(mm)	长度(mm)	数量	单重(kg)	共重(kg)
MA79	PFC-60*60*5	2044	1	13.62	13.62
					表面积(m ²)
					0.72
合计:					13.62

Rev.	0	第一次提报	2019-01-05
Description			

PROJECT: PROPOSED SITE C1
DEVELOPMENT AT L25&A6,
TKO L107, TSEUNG KWAN O,
NEW TERRITORIES

CLIENT: **美特经贸有限公司**
MIDI AGENSIU KONSORTIA Sdn
Units 5-8, Sunray Industrial Centre, 1/F
610 Chee Koo Ling Road, Kowloon
Tel: 23448921-4 Fax: (852) 27775566

MEI TAI TRADING COMPANY
MIDO Engineering Limited

[BLC-10]

Designed by	
Drawn by	
Reviewed by	
Approved by	
Scale	
DWGNO: E1	- BLC-101
REV.	0

22

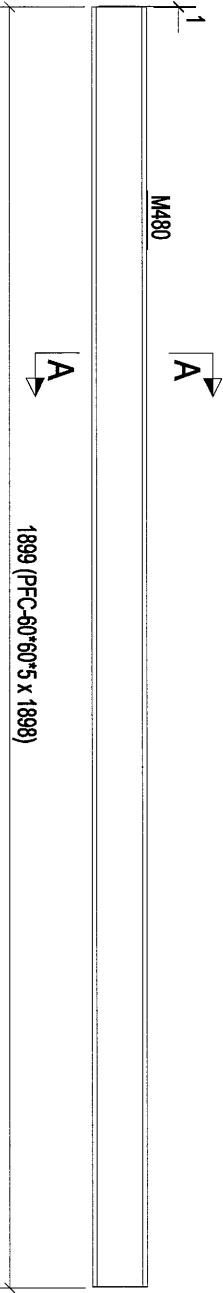

构件: BLC-11

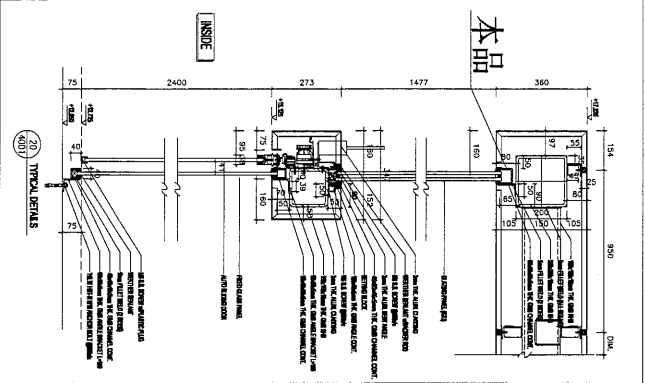
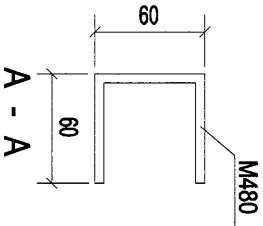

构件编号:	BLC-11	构件数量:	1	构件重量:	12.66
部件编号	规格(mm)	长度(mm)	数量	单重(kg)	共重(kg)
M480	PFC-60*60*5	1899	1	12.66	12.66
合计:					12.66
					表面积(m ²)
					0.57

0	第一次报竣	2019-01-05
Rev.	Description	Date

PROJECT: PROPOSED SITE C1 DEVELOPMENT AT AREA 36, TAOULU 70/P1 TSEUNG KWAN/O, NEW TERRITORIES

CLIENT: 美特鋁質有限公司
MIDI Aluminium Fabricators Ltd.
Units 6-8, Sunny Industrial Centre, 1/F,
610 Chin Kwo Ling Road, Kwailoon
Tel: (852) 489211-4 Fax: (852) 27275665

设计有限公司
LOHAT LIMITED

[BLC-11]

Designed by	
Drawn by	
Reviewed by	
Approved by	
Scale	
DWG NO: E1	- [BLC-11]
REV	0

25

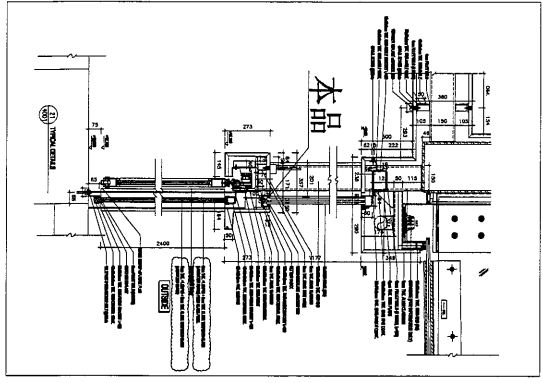
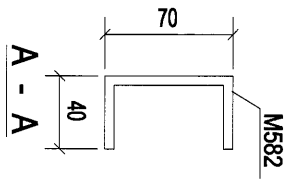
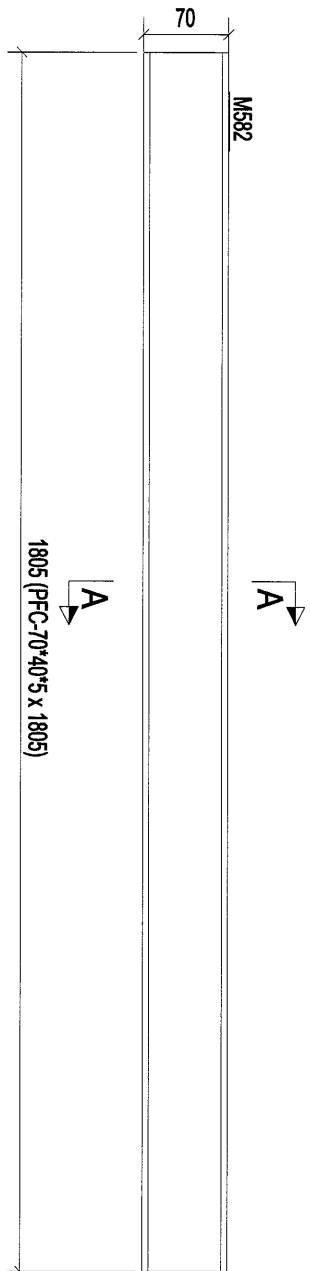

构件: BLC-14

构件编号:	BLC-14	构件数量:	2	构件重量:	9.92
规格(mm)	PFC-70*40*5	长度(mm)	1805	共重(kg)	9.92
数量	1	单重(kg)	9.92	表面积(m ²)	0.52
合计:				9.92	

Rev.	A	第2次设计	2019-01-05
Description			
Date			

PROJECT: PROPOSED SITE C1
DEVELOPMENT AT AREA NO.
TKO1/TOP TISENG KWAN O.
NEW TERRITORIES

CLIENT: 基特經貿有限公司
MIDI Advertising & Marketing Co., Ltd.
Units 6-8, Sunny Industrial Centre, 1/F,
610 Chee Kwo Ling Road, Kowloon
Tel: (852) 9921-1-4 Fax: (852) 27272666



權臣石隆公司
SUNNY INDUSTRIAL CENTRE
[BLC-14]

Designed by	
Drawn by	
Reviewed by	
Approved by	
Scale	
DWG NO.: E1	- BLC-14]
REV.	A

26

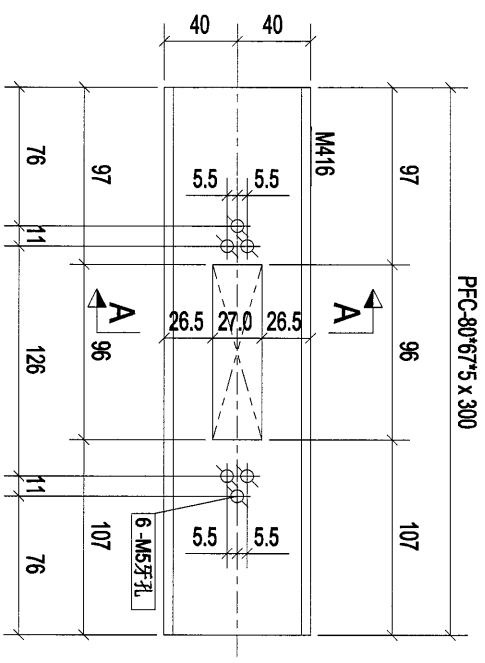

构件: BLC-15

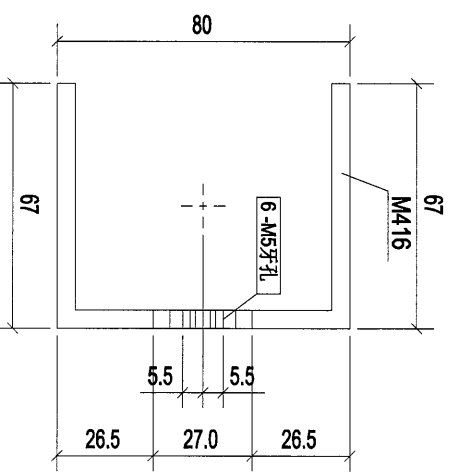

A - A

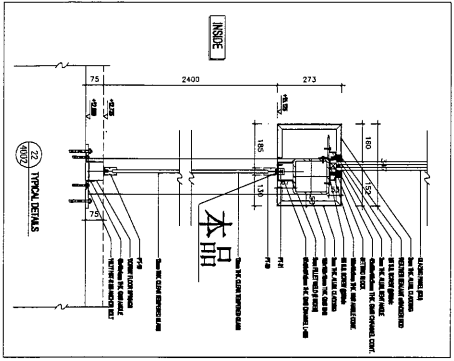

构件编号:	BLC-15	构件数量:	4	构件重量:	240
规格(mm)	PFC-80*67*5	长度(mm)	300	共重(kg)	240
数量	1	单重(kg)	240	表面积(m ²)	0.12
合计:			240		

Rev.	0	第1次提报	2019-01-05
Description			

PROJECT: PROPOSED SITE C1 DEVELOPMENT AT AREA 88, TKOIT TO REP. TSEUNG KWAN O, NEW TERRITORIES

CLIENT: 美特經貿有限公司
MIDI AUSTRONIA ASSOCIATION LTD.
Units 6-8, Sunco Industrial Centre, 1/F
610 Chee Kwo Ling Road, Kowloon
Tel: 23489211-4 Fax: (852) 27272566

[BLC-15]

Designed by	
Drawn by	
Reviewed by	
Approved by	
Scale	
DWGNO: E1	- [BLC-15]
REV	0

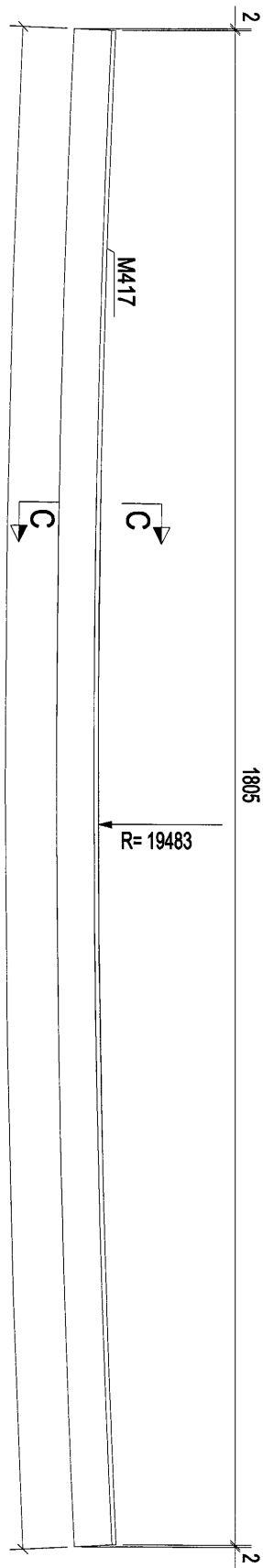

构件: BLC-16

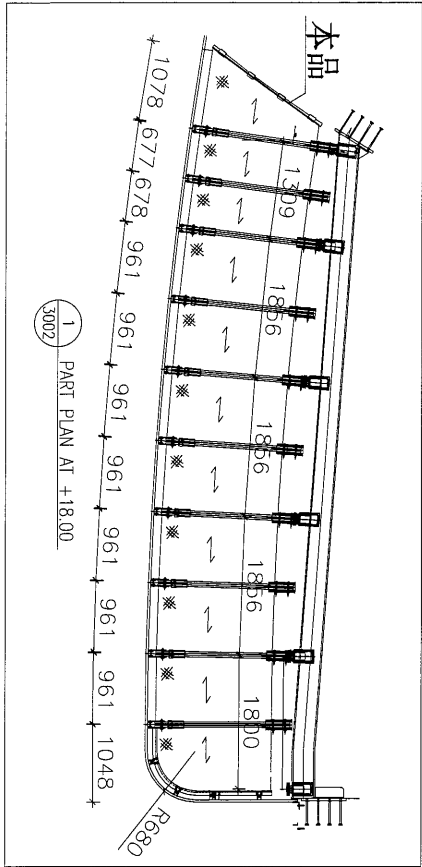
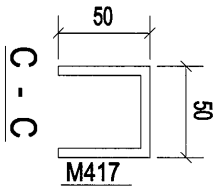

构件编号:	BLC-16	构件数量:	1	构件重量:	9.93
规格(mm)	PFC-50*50*5	长度(mm)	1808	数量	1
表面积(m ²)		重量(kg)	9.93	表面积(m ²)	0.53
合计:		重量(kg)	9.93	表面积(m ²)	0.53

Rev.	Rev. Description	Date
A	第一次设计	2019-01-05

PROJECT: PROPOSED SITE C1 DEVELOPMENT AT AREA 88, TIKOTI TO RP TSEUNG KWAN O, NEW TERRITORIES

CLIENT: 美特經貿有限公司
MIDI AIAWONG KASIKORN CO., LTD.
Units 6-8, Sunny Industrial Centre, 1/F
610 Che Kwo Ling Road, Kowloon
Tel: 23489211-4 Fax: (852) 27272566

總代理 G.P. Engineering Limited

[BLC-16]

Designed by	
Drawn by	
Reviewed by	
Approved by	
Scale	
DWGNO: E1	- [BLC-16]
REV	A

28

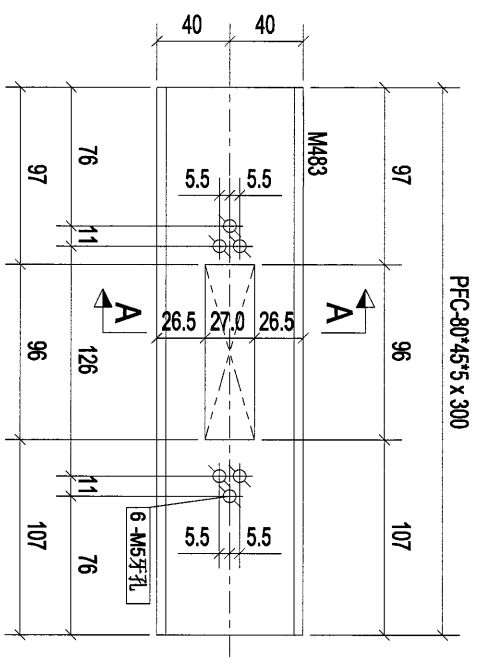

构件: BLC-17

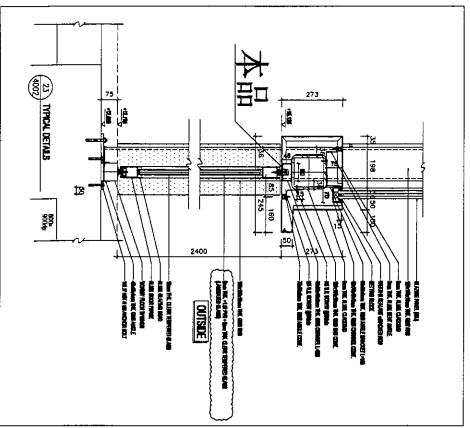
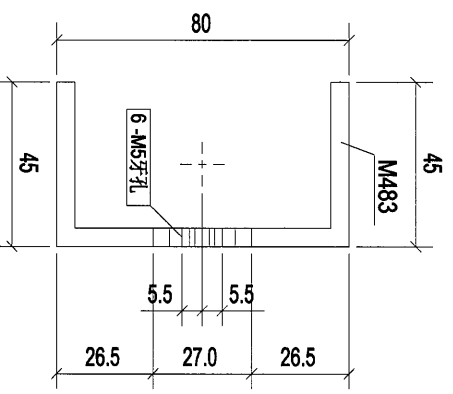

构件编号	规格(mm)	长度(mm)	数量	单重(kg)	共重(kg)	表面积(m ²)
M483	PFC-80*45*5	300	1	1.88	1.88	0.10
构件数量:			4	构件重量: 1.88		
合计:				1.88		

Rev	第几次修改	Date
0	首次设计	2019-01-05

PROJECT: PROPOSED SITE C1
DEVELOPMENT AT TEARAB,
TLOT/LOT/SEKING RIVAN O,
NEW TENGKONGS

CLIENT: 美特經貿有限公司
MIDI Advertising Resources Sdn.
Units 6-8, Sundry Industrial Centre, 1/F
510 Chio Kwo Ling Road, Kajang
Tel: 23489211-4 Fax: (652) 7772566

捷昌石環有限公司
G.P. Seng Guan Limited

BLC-17

Designed by	
Drawn by	
Reviewed by	
Approved by	
Scale	
DWGNO: E1	- BLC-17
REV	0

1749 (PFC-65*60*5 x 1749)

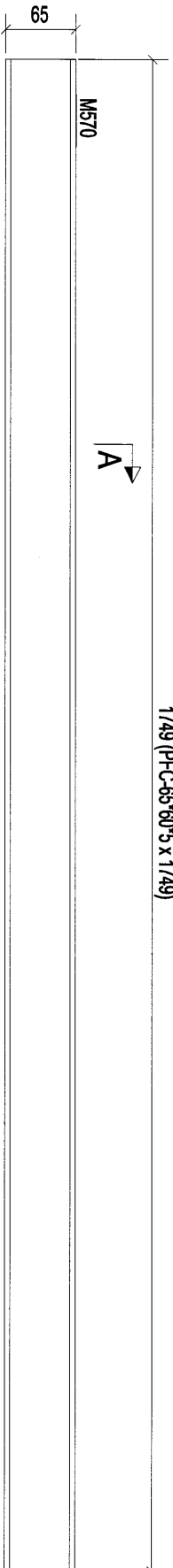

构件: BLC-19

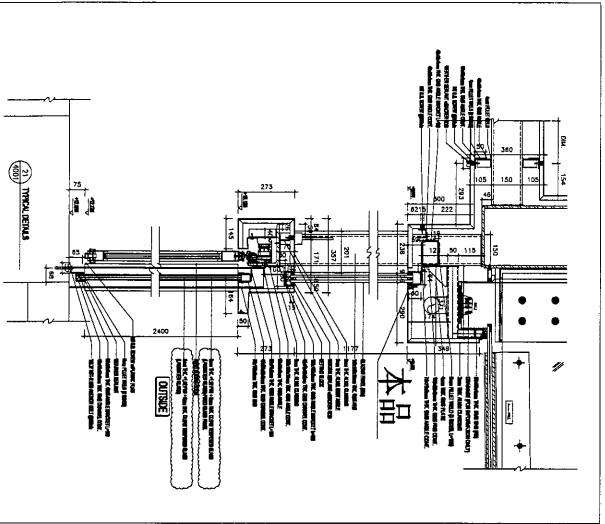
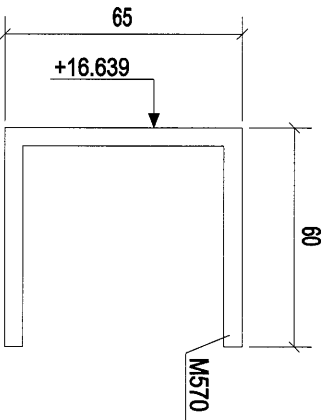

构件编号	规格(mm)	长度(mm)	数量	单重(kg)	共重(kg)	表面积(m ²)
M570	PFC-65*60*5	1749	1	12.02	12.02	0.63
构件数量: 3			构件重量: 12.02		表面积: 0.63	
合计:			12.02			

Rev. A	每次提报	2019-01-05
PROJECT: PROPOSED SITE C1 DEVELOPMENT AT ASIA RS, TLOT, O'R, SEIKONG KWAN O, NEW TERRITORIES		
CLIENT: 美特經貿有限公司 MIDI AUSTRALIAN ASSOCIATION LTD. Units 5-8, Sunray Industrial Centre, 1/F 610 Che Kwo Ling Road, Kowloon Tel: 2348921-4 Fax: (852) 27277556		
 美特經貿有限公司 MIDI AUSTRALIAN ASSOCIATION LTD. Units 5-8, Sunray Industrial Centre, 1/F 610 Che Kwo Ling Road, Kowloon Tel: 2348921-4 Fax: (852) 27277556		
[BLC-19]		
Designed by		
Drawn by		
Reviewed by		
Approved by		
Scale		
DWGNO: E1	- [BLC-19]	
REV.	A	

PFC-65*60*5 x 1694

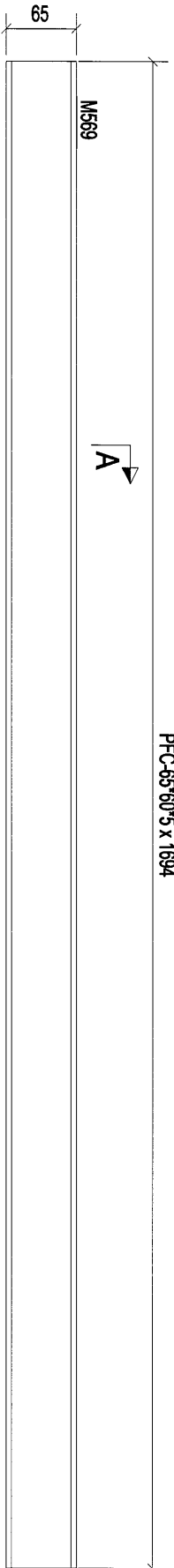

构件: BLC-20

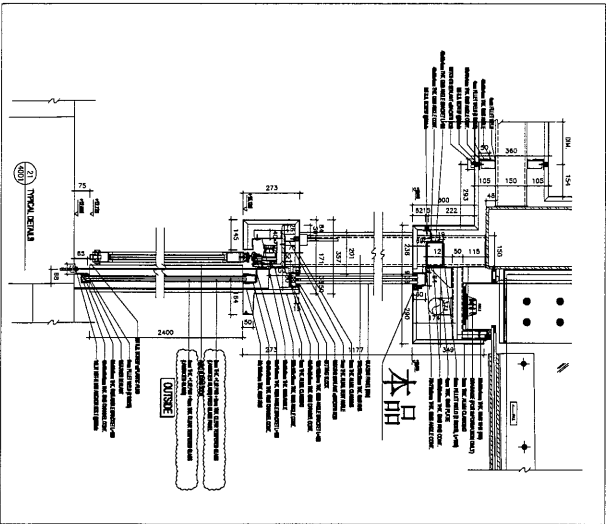
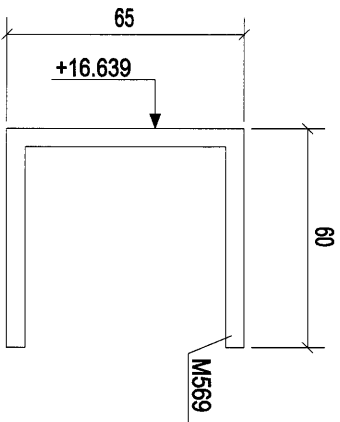

构件编号:	BLC-20	构件数量:	1	构件重量:	11.84
规格(mm)	PFC-65*60*5	长度(mm)	1694	数量	1
		重量(kg)	11.84	共重(kg)	11.84
		表面积(m ²)	0.61	合计:	11.84

Rev.	A	第2次採批	2019-01-05
Description			
Date			
PROJECT:	PROPOSED SITE C1 DEVELOPMENT AT AREA 88, TROTTOIR TSEUNG KWAN O, NEW TERRITORIES		
CLIENT:	 美特銘實有限公司 MIDI Aluminium Manufacturers Ltd. Unit 6-8, Sunny Industrial Centre, 1/F 610 Chee Kwo Ling Road, Kwai Tsing Tel: (2348)211-4 Fax: (2348)277666		
Designed by			
Drawn by			
Reviewed by			
Approved by			
Scale			
DWGNO.:	E1	-	[BLC-20]
REV	A		

[BLC-20]



32

PFC-65*60*5 x 1203

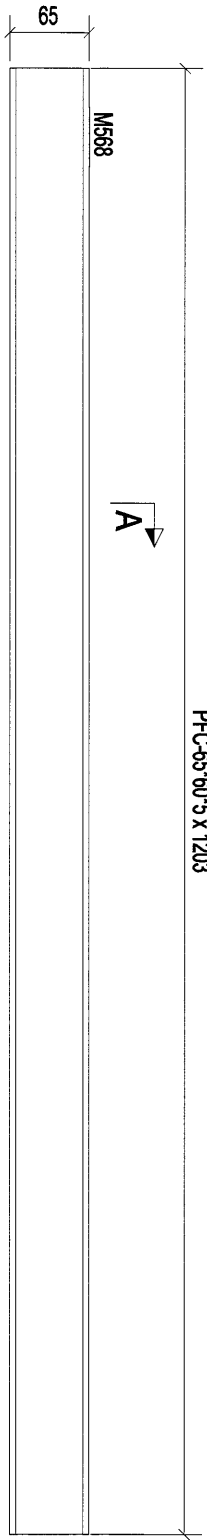

构件: BLC-21

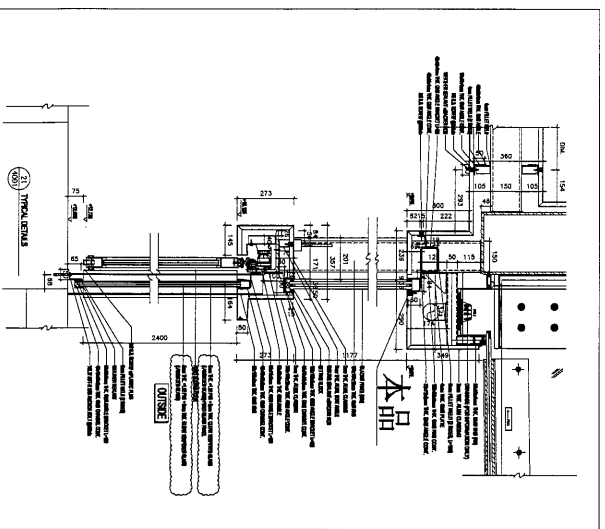
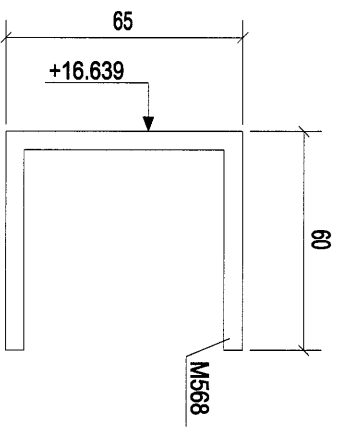

构件编号:	BLC-21	构件数量:	1	构件重量:	8.26
规格(mm)	PFC-65*60*5	长度(mm)	1203	失重(kg)	8.26
数量	1	单重(kg)	8.26	表面积(m ²)	0.43
合计:				8.26	

Rev.	更改描述	Date
A		2019-01-05

PROJECT: PROPOSED SITE C1
DEVELOPMENT AT TERAAS,
TLOT 10/P/ TSEUNG KWAN O,
NEW TERRITORIES

CLIENT: 基特銘實有限公司
MIDI Architecture Associates Ltd.
Units 6-8, Sunray Industrial Centre, 1/F
610 Chea Kwo Ling Road, Kowloon
Tel: 23489211-4 Fax: (852) 27776568

捷成石漆有限公司
MIDI Architecture Associates Ltd.

[BLC-21]

Designed by	
Drawn by	
Reviewed by	
Approved by	
Scale	
DWG NO: E1	- BLC-21
REV	A

33

PFC-60*40*5 x 939

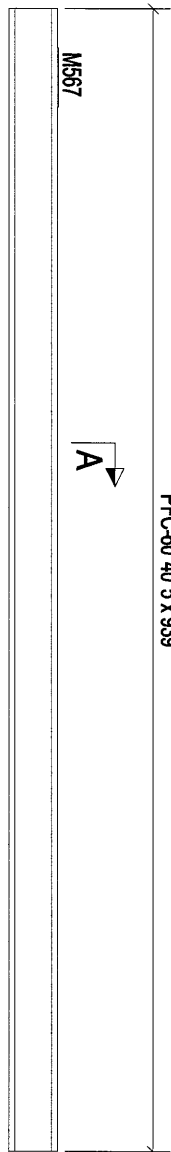

A

构件: BLC-22

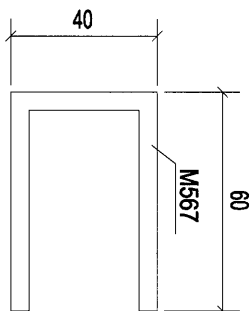

A - A

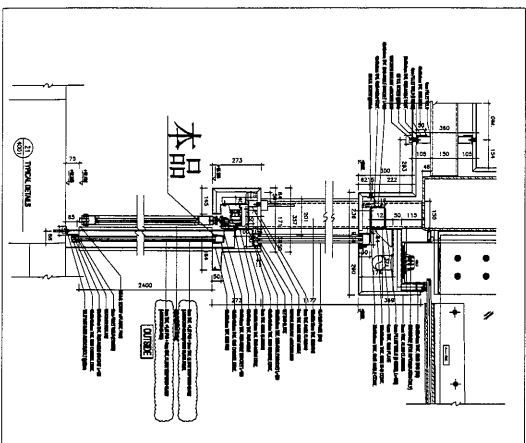

本品

构件编号:	BLC-22	构件数量:	1	构件重量:	5.53
部件编号	规格(mm)	长度(mm)	数量	单重(kg)	表面积(m ²)
M567	PFC-60*40*5	939	1	5.53	0.29
合计:			5.53		

0	第一次提报	2019-01-05
Rev.	Description	Date

PROJECT: PROPOSED SITE C1 DEVELOPMENT AT ASEA 66, TROTTER SEENING RIVAN O, NEW TENOZOMIES

CLIENT: 美特经贸有限公司
MIDI AUSTRALIA PTY LTD
Units 5-8, Sunway Industrial Centre, 1/F
610 Chio Kuo Ling Road, Kowloon
Tel: 23489211-4 Fax: (852) 27277656



[BLC-22]

Designed by	
Drawn by	
Reviewed by	
Approved by	
Scale	
DWG NO: E1	- [BLC-22]
REV	0

24

PFC-70*40*5 x 1696

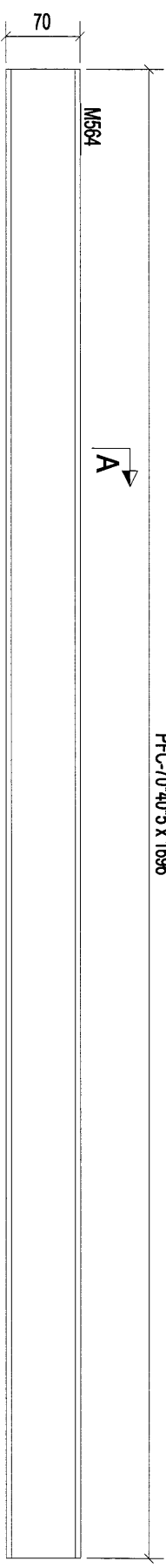

构件: BLC-23

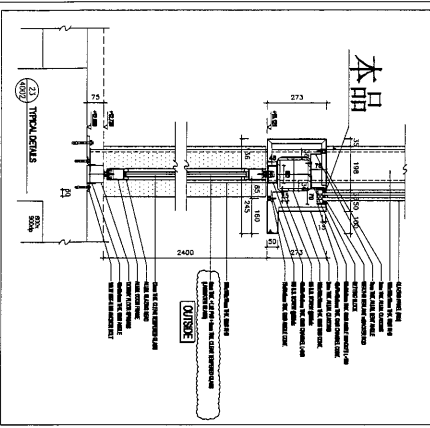
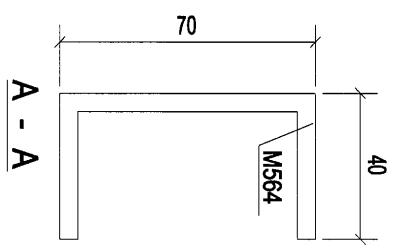

构件编号:	BLC-23	构件数量:	1	构件重量:	9.32
规格(mm)	PFC-70*40*5	长度(mm)	1696	失重(kg)	9.32
数量	1	单重(kg)	9.32	表面积(m ²)	0.49
合计:			9.32		

Rev.	0	第1次设计	2019-01-05
PROJECT:	PROPOSED SITE C1 DEVELOPMENT AT AREA 68, TLOT 70/P, TSEUNG KWAN O, NEW TERRITORIES		
CLIENT:	 美特經貿有限公司 MID I AMMONG KASONGSIE LTD. 610 Che Kwo Ling Road, Kowloon Tel: (852) 27727566		
Designed by			
Drawn by			
Reviewed by			
Approved by			
Scale			
DWG NO.:	E1	-	BLC-23
REV	0		

[BLC-23]



捷昌石隆有限公司
JIECHANG SHILONG LIMITED

35

PFC-70*40*5 x 1205

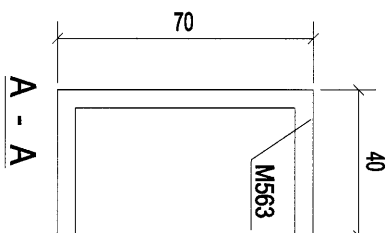
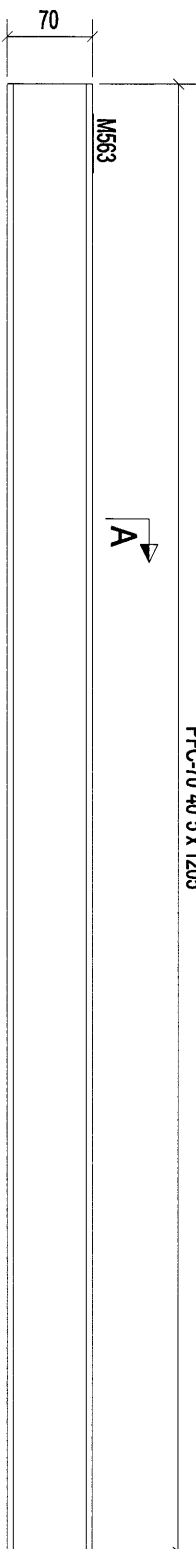

构件: BLC-24

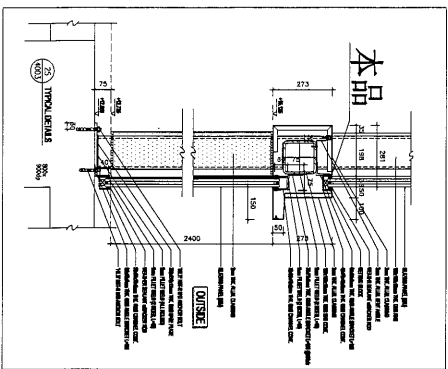

构件编号	规格(mm)	长度(mm)	数量	单重(kg)	共重(kg)	表面积(m ²)	
M563	PFC-70*40*5	1205	1	6.62	6.62	0.35	
构件编号:	BLC-24	构件数量:	1	构件重量:	6.62	表面积:	0.35

合计: 6.62

Rev.	第几次修改	Date
0		2019-01-05

PROJECT: PROPOSED SITE C1
DEVELOPMENT AT AREA A8
TKOIL 70/P2 TSEUNG KWAN O,
NEW TERRITORIES

CLIENT: 美特经贸有限公司
MIDI AIAIYONIA P&S
Units 6-8, Sunny Industrial Centre, 1/F
610 Che Kwo Ling Road, Kowloon
Tel: 23489211-4 Fax: (852) 27272666

SEI YAT LOK LTD
SEI YAT LOK LTD

[BLC-24]

Design	Reviewed	Scale	REV
Designed by	Reviewed by	Scale	0
Drawn by	Approved by		

DWG NO: E1 - BLC-24

26

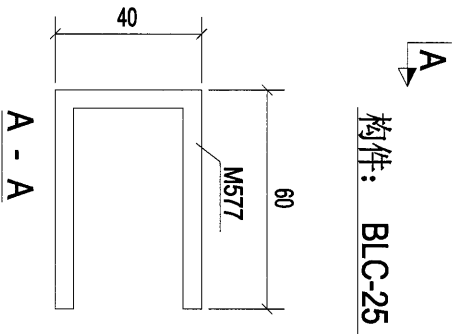
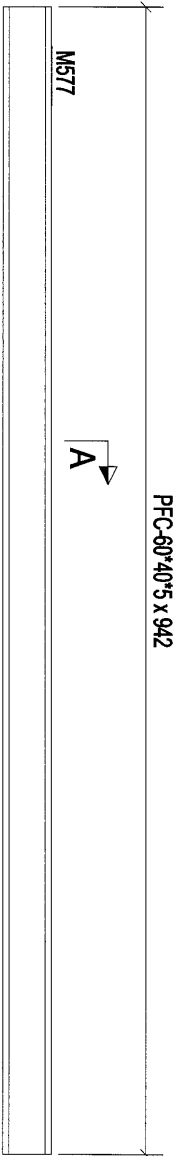

构件: BLC-25

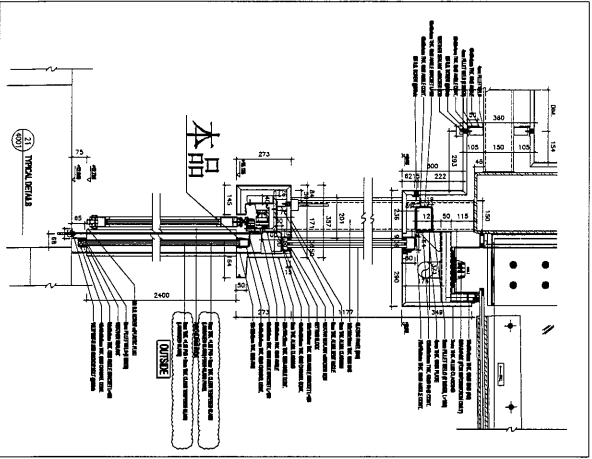

构件编号:	BLC-25	构件数量:	1	构件重量:	5.55
部件编号	规格(mm)	长度(mm)	数量	单重(kg)	共重(kg)
M577	PFC-60*40*5	942	1	5.55	5.55
				表面积(m ²)	0.29
合计:				5.55	

Rev:	0	第1次提报	2019-01-05
Description	PROPOSED SITE C1 DEVELOPMENT AT TERAH, TOTTORI-SENSU RIVAN O, NEW TERRITORIES		
Date			
CLIENT:	 美特銘實有限公司 MIDI Architecture Associates Ltd. Units 6-8, Suncy Industrial Centre, 1/F 610 Cha Kwo Ling Road, Kowloon Tel: 23489211-4 Fax: (852) 27776568		
Designed by			
Drawn by			
Reviewed by			
Approved by			
Scale			
DWGNO.:	E1	-	BLC-25
REV	0		

[BLC-25]

捷昇建築有限公司
 捷昇建築有限公司
 10/ANT Limited

37

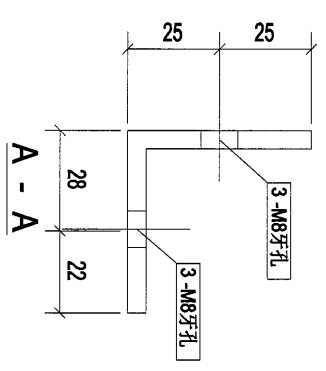
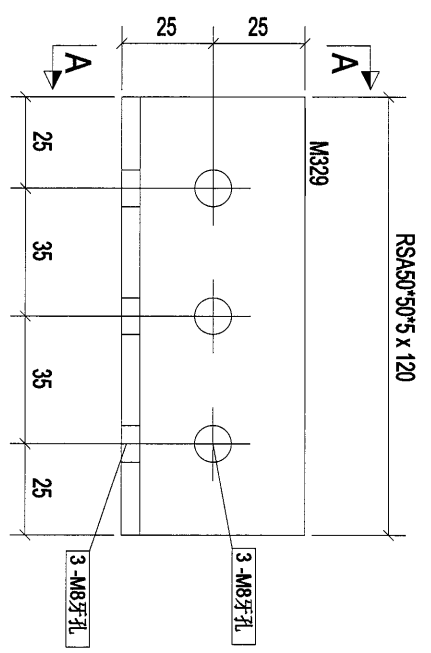

构件: ESJ-1

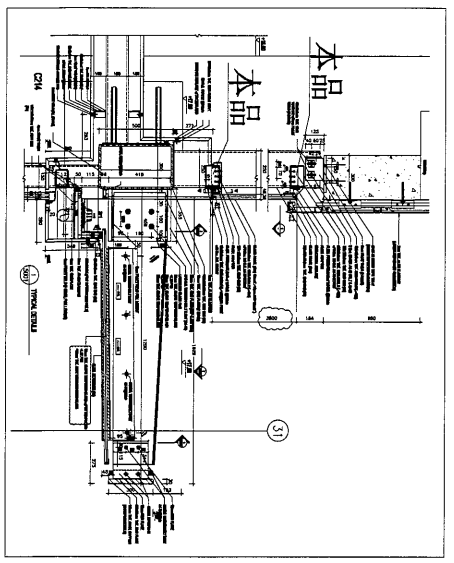

构件编号:	ESJ-1	构件数量:	20	构件重量:	0.45
部件编号	规格(mm)	长度(mm)	数量	单重(kg)	共重(kg)
M329	RSAS0*50*5	120	1	0.45	0.45
				表面积(m ²)	0.02
合计:				0.45	

Rev	A	第2次设计	2019-01-05
Description			

PROJECT: PROPOSED SITE C1
DEVELOPMENT AT ANEAK,
KOTLITOTI, TSENG KWAN O,
NEW TERRITORIES

CLIENT: 基特經貿有限公司
MIDI Automatik Associates Ltd.
Units 6-8, Sunray Industrial Centre, 1/F
610 Chee Kwo Ling Road, Kowloon
Tel: 23489211-4 Fax: (852) 27275656

基特經貿有限公司
MIDI Automatik Associates Ltd.

DESIGNED BY: [Blank]
DRAWN BY: [Blank]
REVIEWED BY: [Blank]
APPROVED BY: [Blank]
SCALE: [Blank]

DWGNO: E1 - [ESJ-1]
REV: A

38

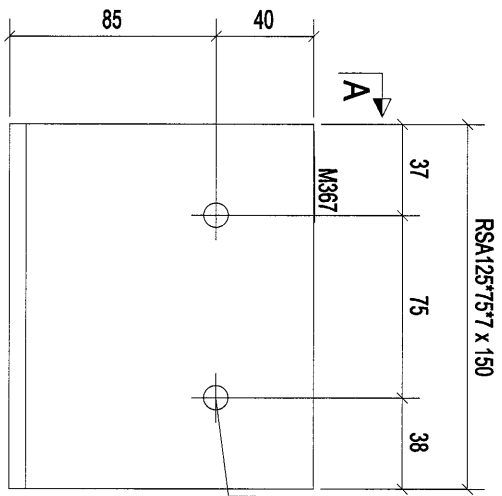

构件: ESJ-2

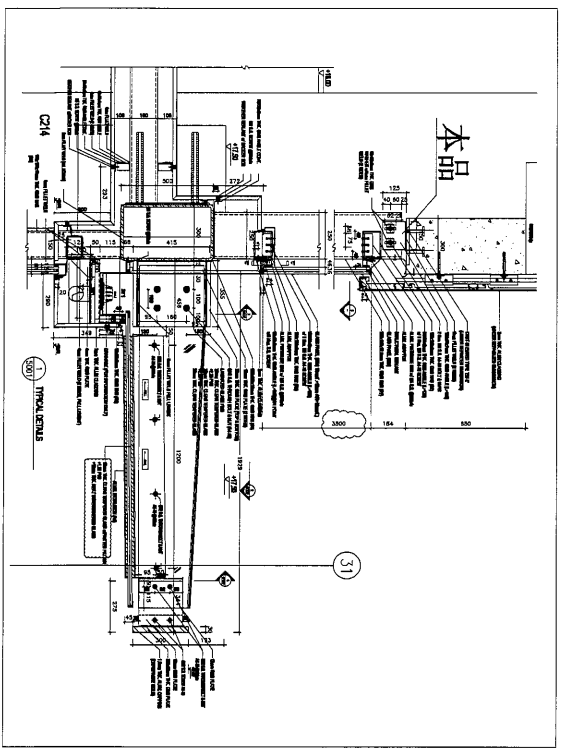
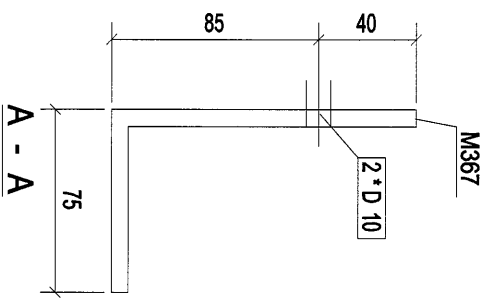

构件编号:	ESJ-2	构件数量:	12	构件重量:	1.59
规格(mm)	150	长度(mm)	150	共重(kg)	1.59
数量	1	单重(kg)	1.59	表面积(m ²)	0.06
合计:	1.59				

Rev.	0	第一次提报	2019-01-05
Description			

PROJECT: PROPOSED SITE C1
DEVELOPMENT AT KEANG,
TOKLEI/TONTISEMBAH KAMPUNG,
NEW TENGKOPOMES

CLIENT: 美特經貿有限公司
MIDI AUSTRALIA AUSTRALIA PTY LTD
Units 6-8, Sunway Industrial Centre, 1/F
610 Chio Kwo Ling Road, Kowloon
Tel: 23489211-4 Fax: (852) 27278568



DESIGNED BY: [ESJ-2]
DRAWN BY:
REVIEWED BY:
APPROVED BY:
SCALE:

DESIGNED BY	
DRAWN BY	
REVIEWED BY	
APPROVED BY	
SCALE	
DWG NO.	E1 - [ESJ-2]
REV.	0

29

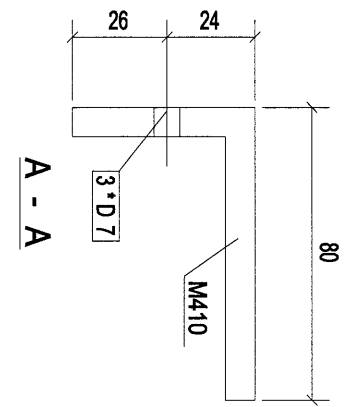
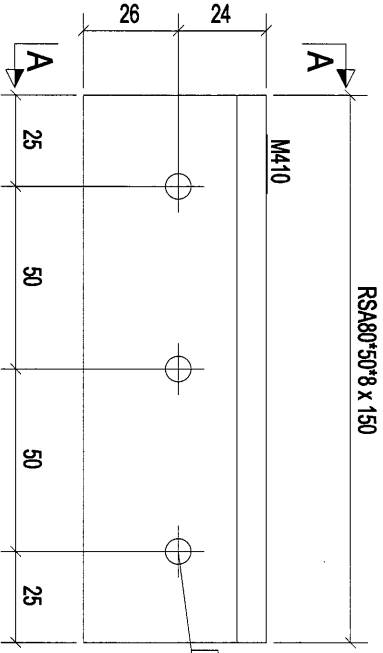

构件: ESJ-3

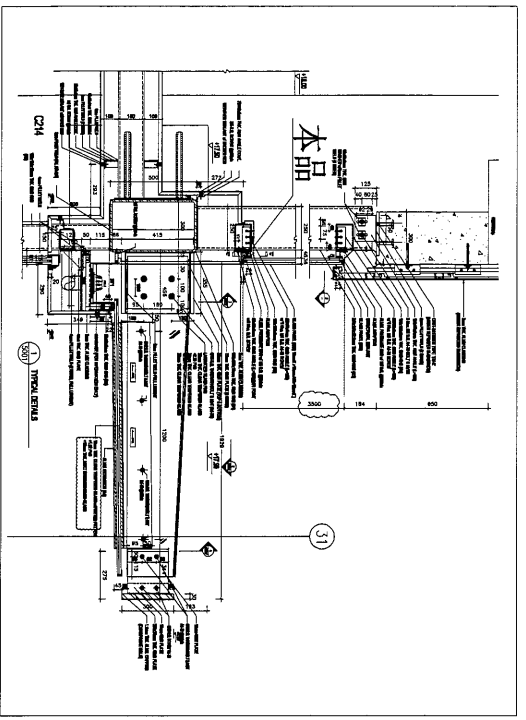

构件编号:	ESJ-3	构件数量:	14	构件重量:	1.15
规格(mm)	150	数量	1	共重(kg)	1.15
长度(mm)	150	单重(kg)	1.15	表面积(m ²)	0.04
部件编号	RSJ80*50*8	合计:	1.15		

Rev.	0	第1次设计	2019-01-05
Description	PROPOSED SITE C1 DEVELOPMENT AT AREA A6, TROTTI OPP. TSEUNG KWAN O, NEW TERRITORIES		

CLIENT: 美特經貿有限公司
 MIDT ALUMINIUM FABRICATOR S.M.
 Units 6-8, Sunny Industrial Centre, 1/F
 610 Chee Kwo Ling Road, Kowloon
 Tel: 23489211-4 Fax: (852) 27272656

捷昌铝业有限公司
 JIECHANG ALUMINIUM CO., LIMITED

[ESJ-3]

Designed by	
Drawn by	
Reviewed by	
Approved by	
Scale	
DWGNO.: E1	- [ESJ-3]
REV	0

40

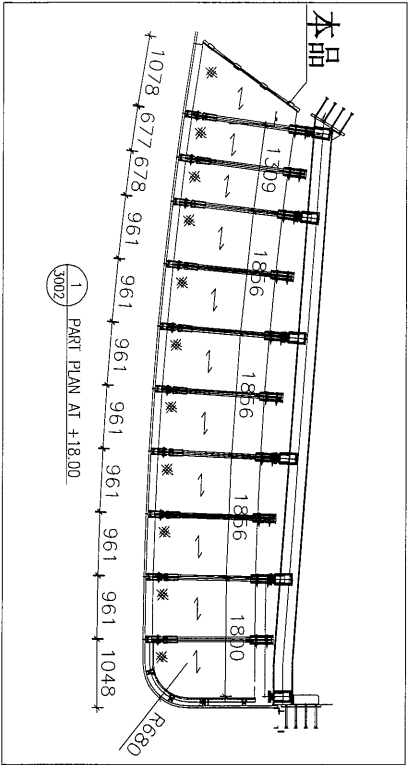
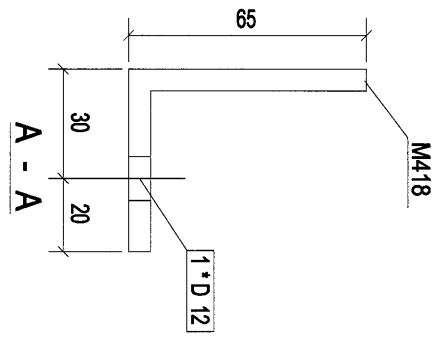
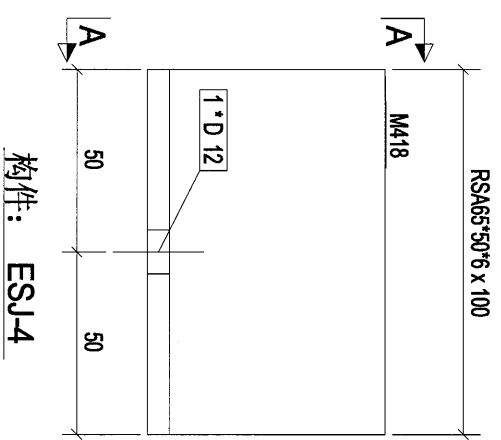

0	第一次提批	2019-01-05
Rev.	Description	Date

PROJECT:
 PROPOSED SITE C1
 DEVELOPMENT AT AREA A8,
 TKOIL TOP TSEUNG KWAN O,
 NEW TERRITORIES

CLIENT:
美特經貿有限公司
 MIDT AUTOMOTIVE RESOURCES LTD.
 Units 6-8, Sunny Industrial Centre, 1/F,
 610 Che Kwo Ling Road, Kowloon
 Tel: 23489211-4 Fax: (852) 27727656

捷日石隆有限公司
 2177 107411 Limited

[ESJ-4]

构件编号:	ESJ-4	构件数量:	4	构件重量:	0.52
规格(mm)	RSAs65*50*6	长度(mm)	100	共重(kg)	0.52
数量	1	单重(kg)	0.52	表面积(m ²)	0.02
合计:			0.52		

Designed by	
Drawn by	
Reviewed by	
Approved by	
Scale	
DWGNO: E1	- [ESJ-4]
REV	0

(41)

1755 (SHSS0*50*5.0 x 1755)

MA73

构件: ESJ-5

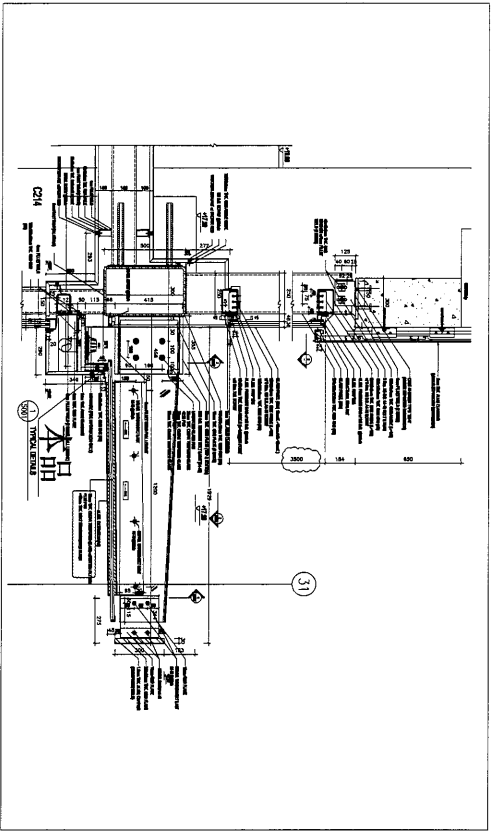

构件编号:	ESJ-5	构件数量:	1	构件重量:	12.03
规格(mm)	SHSS0*50*5.0	长度(mm)	1755	数量	1
重量(kg)	12.03	表面积(m ²)	0.33	共重(kg)	12.03
合计:	12.03				

Rev.	0	第1次设计	2019-01-05
Description			
Date			

PROJECT: PROPOSED SITE C1 DEVELOPMENT AT AREA A8, TLOT 70/P/ TSEUNG KWAN O, NEW TERRITORIES

CLIENT: 美特銘實有限公司
MIDI AUTOMOTIVE PARTS (HK) LTD.
Units 6-8, Sunny Industrial Centre, 1/F
610 Chee Kwo Ling Road, Kowloon
Tel: 23489211-4 Fax: (852) 27727656

[ESJ-5]

Designed by	
Drawn by	
Reviewed by	
Approved by	
Scale	
DWG NO: E1	- [ESJ-5]
REV	0

42

SHS50*50*5.0 x 1865

M474

构件: ESJ-6

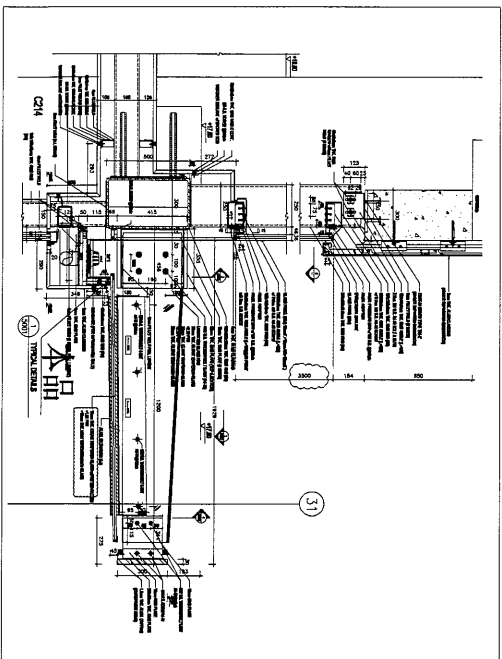

构件编号	规格(mm)	长度(mm)	数量	单重(kg)	共重(kg)	表面积(m ²)
M474	SHS50*50*5.0	1865	1	12.78	12.78	0.35
合计:					12.78	

Rev.	Revision Description	Date
0	第一次提报	2019-01-05

PROJECT: PROPOSED SITE C1
DEVELOPMENT AT AREA A6,
TOKYO TOWN, SEISHU-KU, NAGANO,
NEW TERRITORIES

CLIENT: 美特經貿有限公司
MIDI INTERNATIONAL ASSOCIATES LTD.
Units 5-8, Sunny Industrial Centre, 1/F
610 Chee Kwo Ling Road, Kowloon
Tel: 23489211-4 Fax: (852) 27279566



[ESJ-6]

Designed by	
Drawn by	
Reviewed by	
Approved by	
Scale	
DWG NO: E1	- [ESJ-6]
REV.	0

43

1340 (SHSS0°50°5.0 x 1340)

MS48

构件: ESJ-7

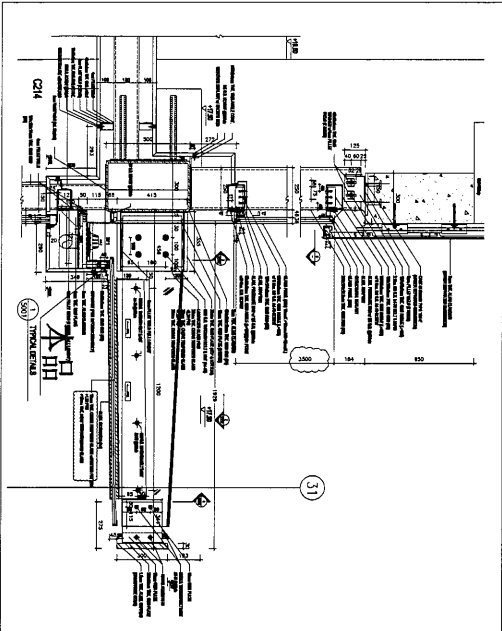

构件编号	规格(mm)	长度(mm)	数量	单重(kg)	构件重量	表面积(m ²)
MS48	SHSS0°50°5.0	1340	1	9.18	9.18	0.25
合计:					9.18	

Rev.	第几次修改	Date
0		2019-01-05

PROJECT: PROPOSED SITE C1
DEVELOPMENT AT TASEA RR,
KOTLORUTSENG RIVANNO,
NEW TENGKONGS

CLIENT: 美特经贸有限公司
MIDI AUSTRALIAN ASSOCIATE PTE
Units 5-8, Sunray Industrial Centre, 1/F
610 Chio Kwo Ling Road, Kowloon
Tel: 23489211-4 Fax: (852) 27727656



DESIGN NO.: E1 - [ESJ-7]

Designed by	
Drawn by	
Reviewed by	
Approved by	
Scale	
DWG NO.: E1	REV: 0

44

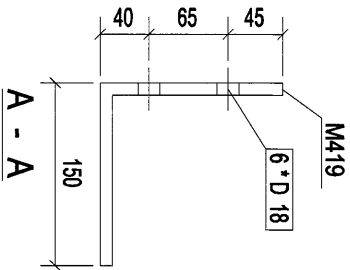
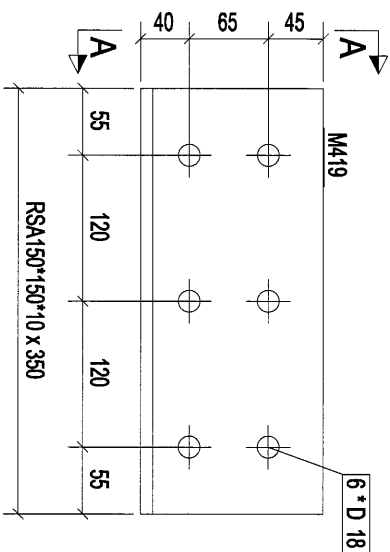

构件: ESJ-8

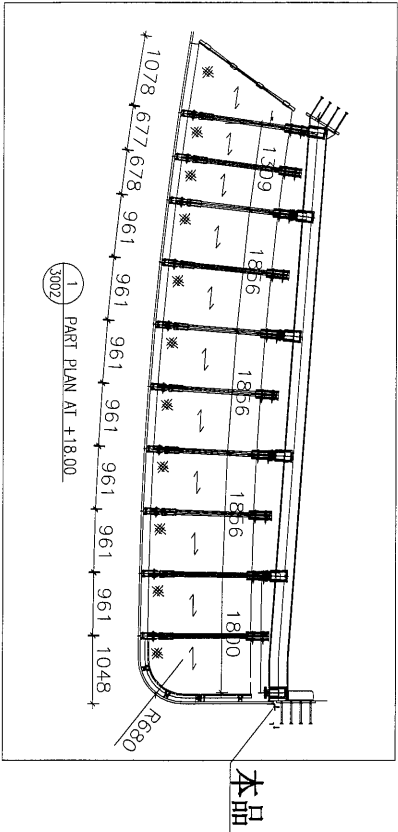

0	第一次报批	2019-01-05
Rev.	Description	Date

PROJECT:
PROPOSED SITE C1
DEVELOPMENT AT AREA A6,
TOTTORI TSEUNG KWAN O,
NEW TERRITORIES

CLIENT:
MIDI 美特鋁質有限公司
Autumn Aluminium Industries Ltd.
Units 6-8, Sunny Industrial Centre, 1/F
610 Chee Kwo Ling Road, Kowloon
Tel: (852) 27727665 Fax: (852) 27727666

美特鋁質有限公司
MIDI Autum Aluminium Industries Ltd.

[ESJ-8]

构件编号:	ESJ-8	构件数量:	1	构件重量:	8.09
规格(mm)	RSA150*150*10	长度(mm)	350	共重(kg)	8.09
数量	1	单重(kg)	8.09	表面积(m ²)	0.21
合计:				8.09	

Designed by	
Drawn by	
Reviewed by	
Approved by	
Scale	
DWGNO: E1	- [ESJ-8]
REV	0

45

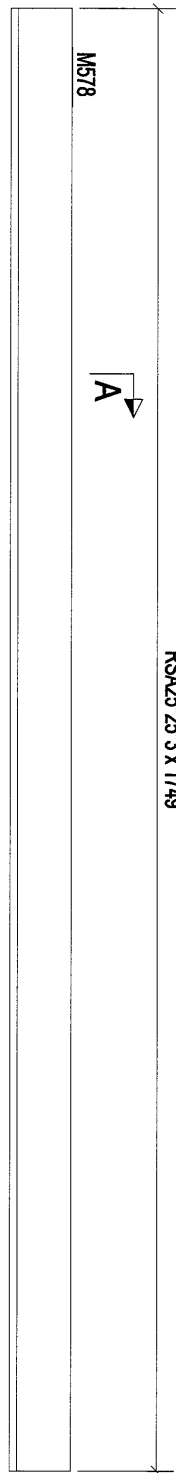

A

构件: ESJ-9

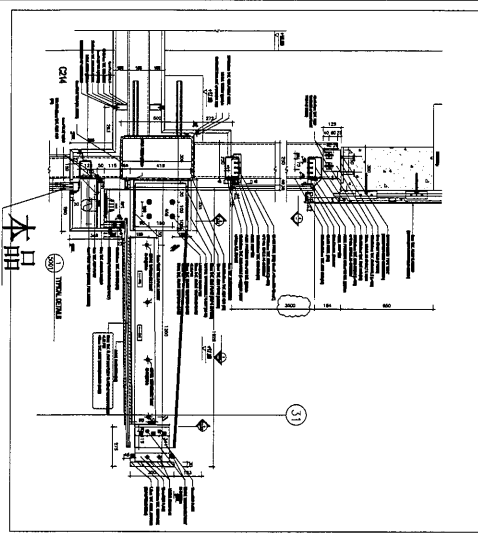
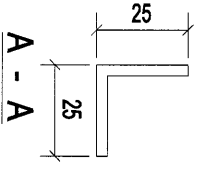

构件编号:	ESJ-9	构件数量:	3	构件重量:	1.94
部件编号	规格(mm)	长度(mm)	数量	单重(kg)	共重(kg)
M578	RSA25*25*3	1749	1	1.94	1.94
合计:				1.94	0.17

Rev.	0	第1次设计	2019-01-05
Description			

PROJECT: PROPOSED SITE C1
DEVELOPMENT AT AREA 88,
KOTILTOR, TSEUNG KWAN O,
NEW TERRITORIES

CLIENT: 美特经贸有限公司
MIDI INTERNATIONAL TRADING CO., LTD.
510 Chee Koo Ling Road, Kowloon
Tel: 23489211-4 Fax: (852) 27727866



[ESJ-9]

Designed by	
Drawn by	
Reviewed by	
Approved by	
Scale	
DWG NO.:	E1 - [ESJ-9]
REV.	0

46

RS425*25*3 x 1694

M580



构件: ESJ-10

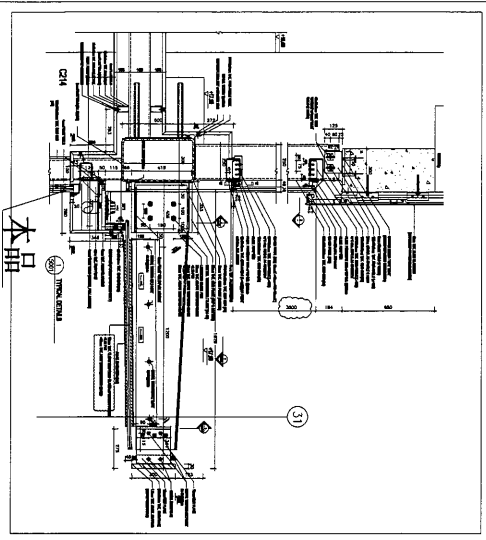
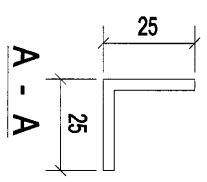

构件编号:	ESJ-10	构件数量:	1	构件重量:	1.88
部件编号	规格(mm)	长度(mm)	数量	单重(kg)	共重(kg)
M580	RS425*25*3	1694	1	1.88	1.88
					表面积(m ²)
					0.17
合计:					1.88

0	第一次校核	2019-01-05
Rev.	Description	Date

PROJECT:
 PROPOSED SITE C1
 DEVELOPMENT AT AREA 88
 TIKOTI TO RP TSEUNG KWAN O,
 NEW TERRITORIES

CLIENT:
 美特經貿有限公司
 MIDT ADVANTAGE TRADING LTD.
 Units 6-8, Sunray Industrial Centre, 1/F
 610 Che Kwo Ling Road, Kowloon
 Tel: 23489211-4 Fax: (852) 27727656

美特經貿有限公司
 MIDT ADVANTAGE TRADING LTD.

[ESJ-10]

Designed by	
Drawn by	
Reviewed by	
Approved by	
Scale	
DWGNO: E1	- [ESJ-10]
REV	0

47

RSA25*25*3 x 1203

M579



构件: ESJ-11

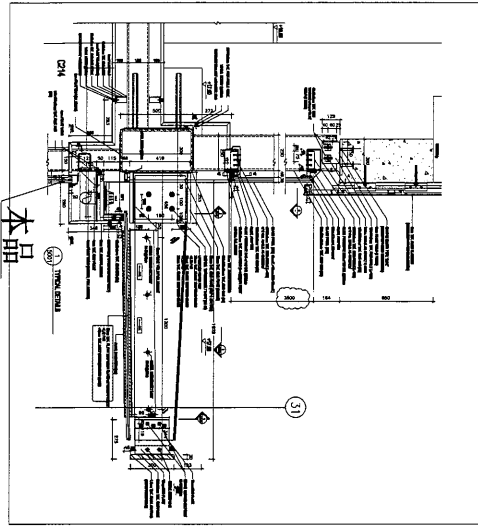
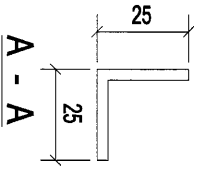

构件编号	规格(mm)	长度(mm)	数量	单重(kg)	共重(kg)	表面积(m ²)
M579	RSA25*25*3	1203	1	1.33	1.33	0.12
合计:					1.33	

0	第1次设计	2019-01-05
Rev.	Description	Date

PROJECT: PROPOSED SITE C1 DEVELOPMENT AT AREA A8, TLOT 70 RP, TSEUNG KWAN O, NEW TERRITORIES

CLIENT: 美特銘實有限公司
MIDI Aluminium Malaysia Sdn. Bhd.
Units 6-8, Sunray Industrial Centre, 1/F
610 Chee Kwo Ling Road, Kowloon
Tel: 23489211-4 Fax: (852) 27276666

设计: 捷成石塔有限公司
SIYU LOKAT Limited

[ESJ-11]

Designed by	
Drawn by	
Reviewed by	
Approved by	
Scale	
DWGNO: E1	- ESJ-11
REV	0

49

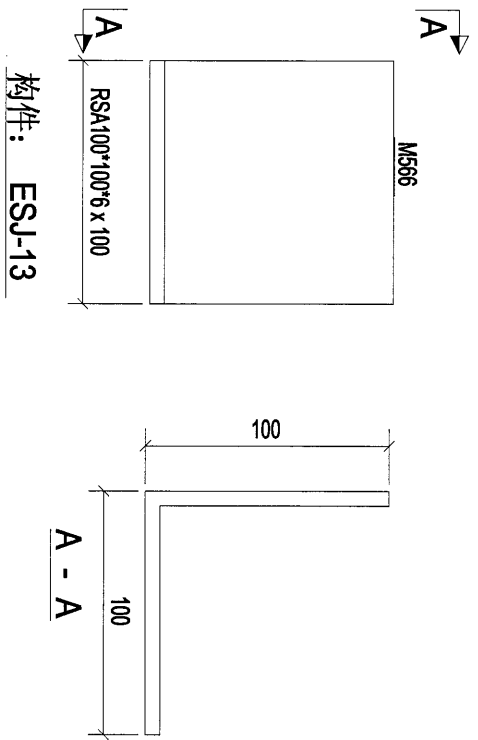

构件: ESJ-13

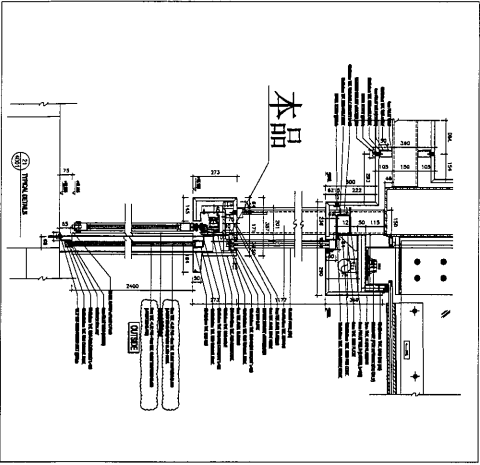

构件编号	规格(mm)	长度(mm)	数量	单重(kg)	共重(kg)	表面积(m ²)
M566	RSA100*100*6	100	1	0.91	0.91	0.04
构件数量: 12		构件重量: 0.91		表面积: 0.04		
合计:		0.91				

Rev. 0	首次报批	2019-01-05
Rev. Description	DATE	
PROJECT: PROPOSED SITE C1 DEVELOPMENT AT PASAR, TOLITOLI, SELANGOR, NEW TERRITORIES		
CLIENT: 基特經貿有限公司 MIDJ AUTOMOTIVE ASSOCIATION Sdn. 510 Chio Kwo Ling Road, Kajang Tel: 23489211-4 Fax: (652) 7272666		
權臣石隆有限公司 SHI YONG IOMT Limited		
[ESJ-13]		
Designed by		
Drawn by		
Reviewed by		
Approved by		
Scale		
DWGNO: E1	- [ESJ-13]	REV. 0

50

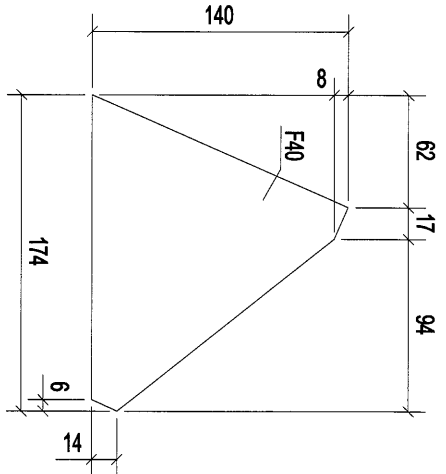

构件: ESJ-14

本品

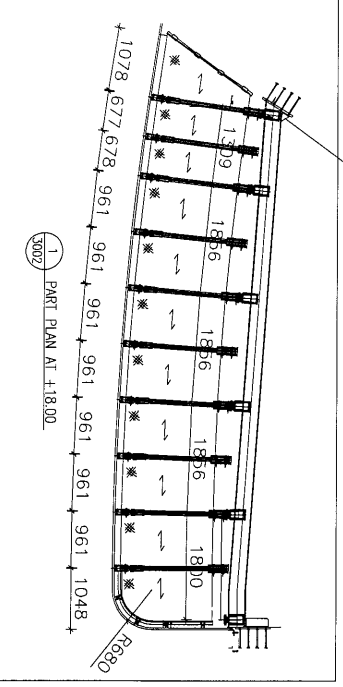

构件编号:	ESJ-14		构件数量:	2		构件重量:	2.87	
规格(mm)	PL15*140.5		长度(mm)	174		共重(kg)	2.87	
数量	1		单重(kg)	2.87		表面积(m ²)	0.03	
合计:			重量	2.87		面积	0.03	

Rev.	0	第一次设计	Date	2019-01-05
Description	PROJECT: PROPOSED SITE C1 DEVELOPMENT AT AREA 88, KOTLORP, TSEUNG KWAN O, NEW TERRITORIES			

CLIENT: 美特經貿有限公司
 MIDT Advisory & Construction Ltd.
 Units E-8, Sunco Industrial Centre, 1/F
 610 Chee Koo Ling Road, Kowloon
 Tel: 23489211-4 Fax: (852) 27272566

美特經貿有限公司
 MIDT Advisory & Construction Ltd.
 2019年1月5日
 2019年1月5日

DESIGNED BY: [ESJ-14]
 DRAWN BY:
 REVIEWED BY:
 APPROVED BY:
 SCALE:

DESIGNED BY:	
DRAWN BY:	
REVIEWED BY:	
APPROVED BY:	
SCALE:	
DWG NO.:	E1 - ESJ-14
REV.	0

57

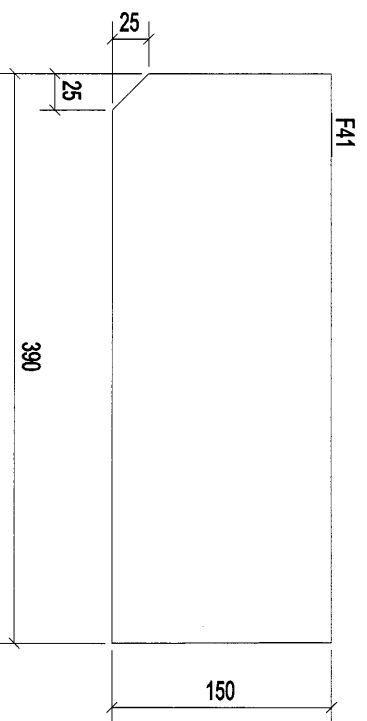

构件: ESJ-15

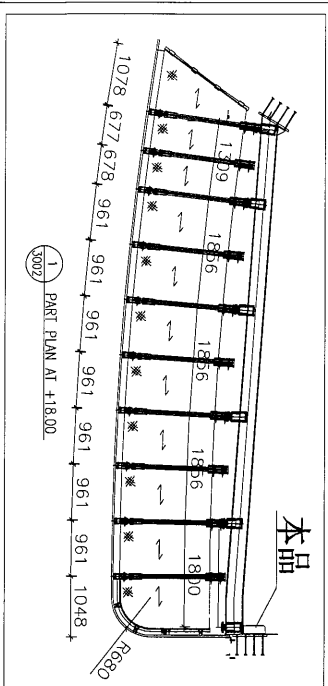

构件编号:	ESJ-15	构件数量:	2	构件重量:	6.90
规格(mm)	PLT15*150	长度(mm)	390	数量	1
F41		重量(kg)	6.90	共重(kg)	6.90
		表面积(m ²)	0.13		

合计:	6.90
DWGNO: E1	- [ESJ-15]
REV	0

0	第1次謀取	2019-01-05
Rev:	Description	Date
PROJECT: PROPOSED SITE C1 DEVELOPMENT AT TERAAS, TOTAL/OT/PT/SEUNG KWAN/O, NEW TERRITORIES		
CLIENT: 美特經貿有限公司 MIDI AMMONG TRADING LTD. Units 6-8, Sunry Industrial Centre, 1/F 610 Che Kwo Ling Road, Kwailoon Tel: 23489211-4 Fax: (852) 27276568		
 捷日工業中心 SUNRY INDUSTRIAL CENTRE		
[ESJ-15]		
Designed by		
Drawn by		
Reviewed by		
Approved by		
Scale		

52

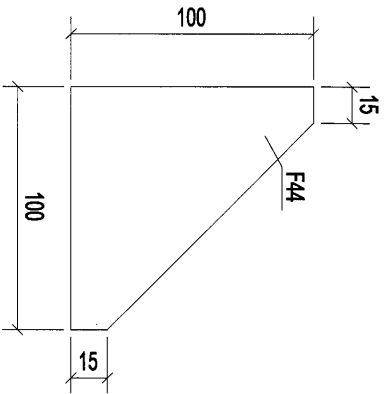

构件: ESJ-16

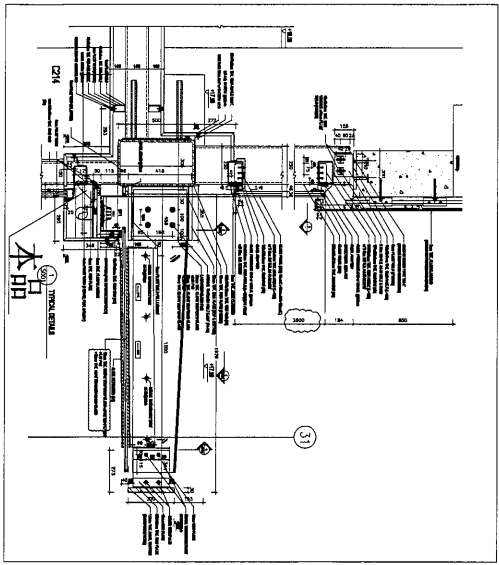

0	第一次校核	2019-01-05
Rev.	Description	Date

PROJECT: PROPOSED SITE C1
DEVELOPMENT AT TEPAK,
KOTLLOTU, SEREMBANG RIVANJO,
NEB TERRITORIES

CLIENT: 美特經貿有限公司
MIDI AUTOMOTIVE PARTS SDN. BHD.
Units 6-8, Sunway Industrial Centre, 1/F
610 Che Koo Ling Road, Kelantan
Tel: 23489211-4 Fax: (852) 27278568

捷成石業有限公司
SUNWAY CONSTRUCTION LIMITED

[ESJ-16]

构件编号:	ESJ-16	构件数量:	6	构件重量:	0.31
规格(mm)	PLT4*100	长度(mm)	100	共重(kg)	0.31
F44		数量	1	表面积(m ²)	0.01
		单重(kg)	0.31	合计:	0.31

Designed by	
Drawn by	
Reviewed by	
Approved by	
Scale	
DWGNO.: E1	- [ESJ-16]
REV	0

53

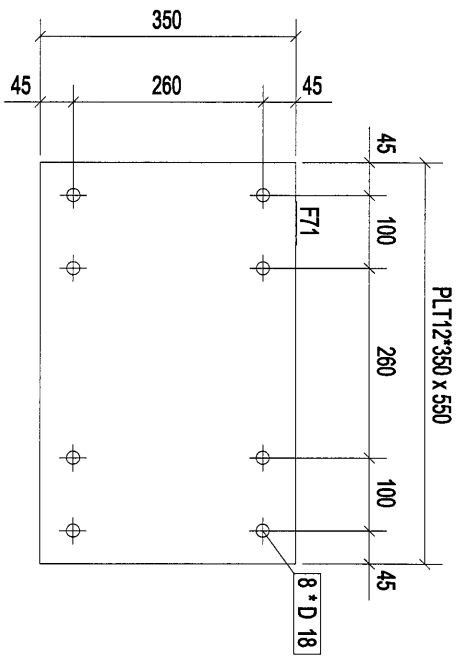

构件: ESJ-17

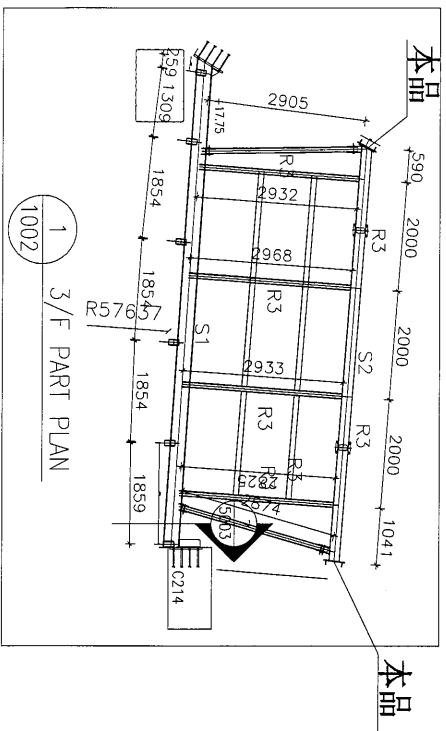

Rev.	0	首次跟进	2019-01-05
Description	PROJECT: PROPOSED SITE C1 DEVELOPMENT AT AREA 08, TKOIL TONG TSEUNG KWAN O, NEW TERRITORIES		
Date			
CLIENT:	 華特經貿有限公司 MIDT Advertising & Marketing Ltd. Units E-4, Sunco Industrial Centre, 1/F, 610 Chee Kwo Ling Road, Kowloon Tel: 23489211-4 Fax: (852) 27272666		
Designed by	[ESJ-17]		
Drawn by			
Reviewed by			
Approved by			
Scale			
DWGNO.	E1	-	[ESJ-17]
REV.	0		

构件编号:	ESJ-17	构件数量:	2	构件重量:	18.13
部件编号:	规格(mm)	长度(mm)	数量	单重(kg)	共重(kg)
F71	PLT12*350	550	1	18.13	18.13
合计:				18.13	0.41

54

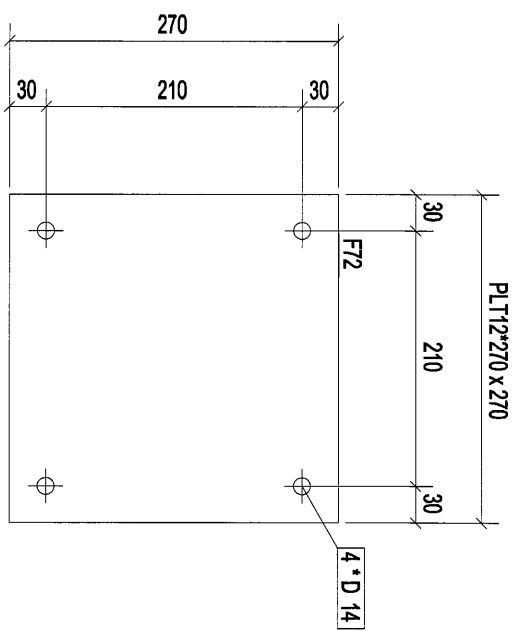

构件: ESJ-18

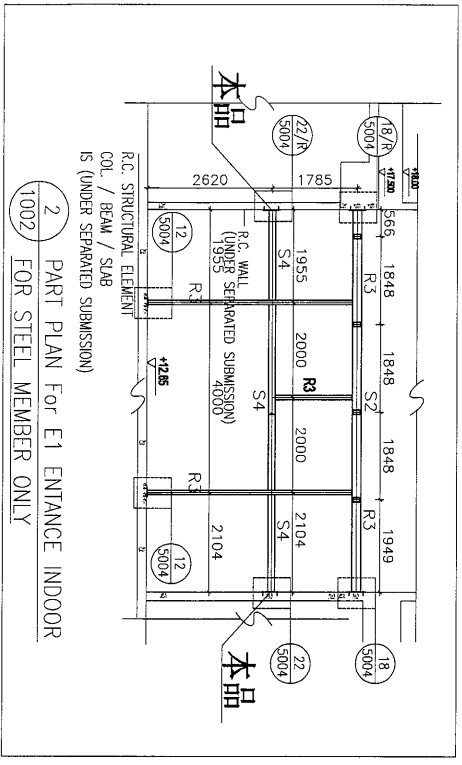

Rev.	0	第一次提报	2019-01-05
Description			

PROJECT: PROPOSED SITE C1
DEVELOPMENT AT AREA A,
KOTLORU, TSEUNG KWAN O,
NEW TERRITORIES

CLIENT: 美特經貿有限公司
MIDI Investment Association Ltd.
Units 6-8, Sunray Industrial Centre, 1/F
610 Chee Kwo Ling Road, Kowloon
Tel: 23469211-4 Fax: (852) 27276565



[ESJ-18]

构件编号	ESJ-18	构件数量	3	构件重量	6.87
规格(mm)	PLT12*270	长度(mm)	270	共重(kg)	6.87
数量	1	单重(kg)	6.87	表面积(m ²)	0.16
合计:				6.87	

Designed by	
Drawn by	
Reviewed by	
Approved by	
Scale	
DWGNO.:	E1 - [ESJ-18]
REV.	0

55

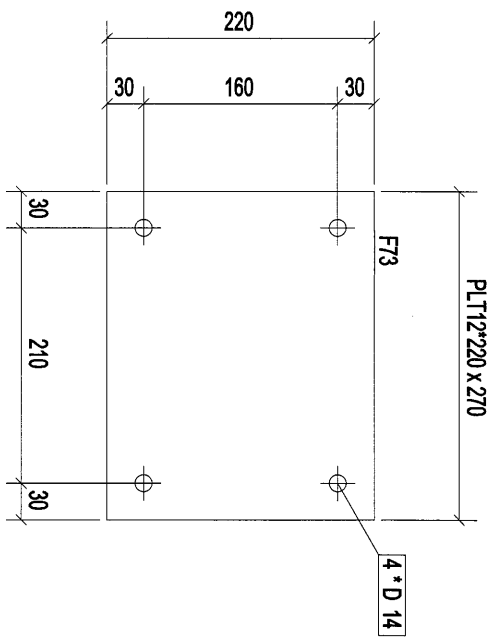

构件: ESJ-19

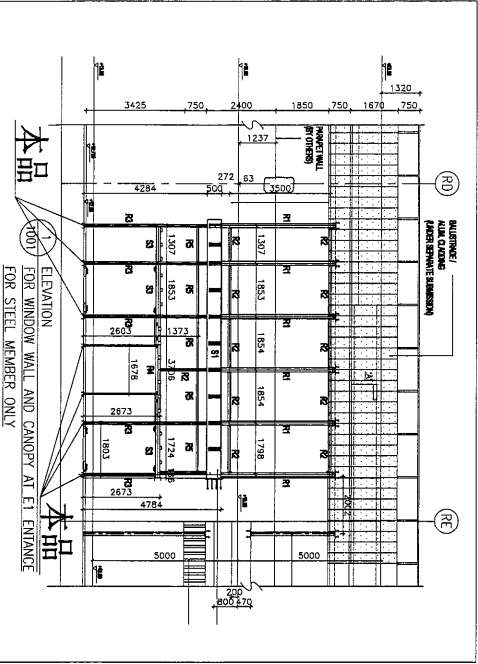

构件编号:	ESJ-19	构件数量:	9	构件重量:	5.60
规格(mm)	PLT12*220	长度(mm)	270	数量	1
重量(kg)		表面积(m ²)	5.60	共重(kg)	5.60
			0.13		
合计:			5.60		

0	第一次校核	2019-01-05
Rev.	Description	Date

PROJECT: PROPOSED SITE C1 DEVELOPMENT AT AREA A8, TQUT 20/REP TSEUNG KWAN O, NEW TERRITORIES

CLIENT: 美特經貿有限公司
MIDI Aesthetics Associates Ltd.
Units 6-8, Sunny Industrial Centre, 1/F
610 Chee Kwo Ling Road, Kwailoon
Tel: (852) 27727668 Fax: (852) 27727668



[ESJ-19]

Designed by	
Drawn by	
Reviewed by	
Approved by	
Scale	
DWGNO: E1	- [ESJ-19]
REV	0

56

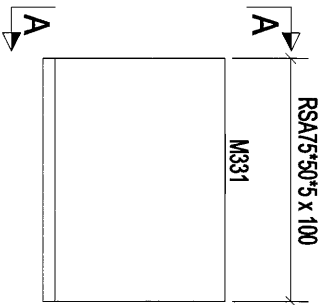

构/件: ESJ-20

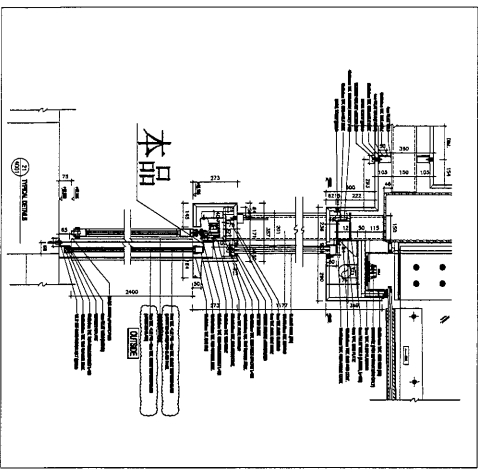
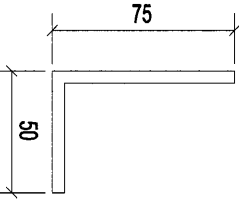

构件编号	规格(mm)	长度(mm)	数量	单重(kg)	共重(kg)	表面积(m ²)
M331	RS A75*50*5	100	1	0.47	0.47	0.03
构件重量:			8	0.47		
数量:			1	0.47		
合计:				0.47		

Rev.	Description	Date
0	第1次设计	2019-01-05

PROJECT:
 PROPOSED SITE C1
 DEVELOPMENT AT AREA A8,
 TKO T20/P TSEUNG KWAN O,
 NEW TERRITORIES

CLIENT:
美特 經 實 有 限 公 司
MIDI ALUMINUM MANUFACTURE LTD.
 Units 6-8, Sunny Industrial Centre, 1/F
 610 Chin Kwo Ling Road, Kowloon
 Tel: 23489211-4 Fax: (852) 27276665

世 昌 石 灰 有 限 公 司
SHI CHEUNG LIME LIMITED

[ESJ-20]

Designed by	
Drawn by	
Reviewed by	
Approved by	
Scale	
DWG NO: E1	- [ESJ-20]
REV	0

(57)

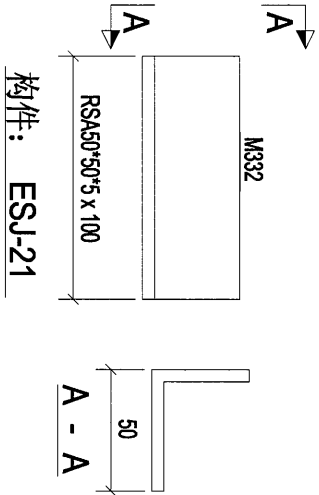

构件: ESJ-21

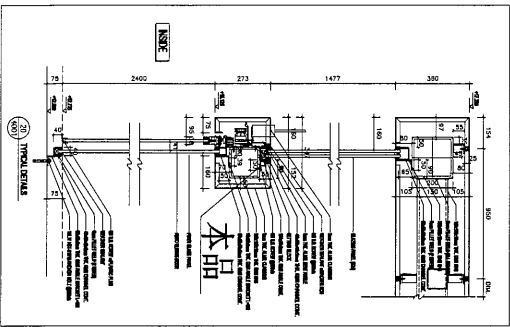

构件编号:	ESJ-21	构件数量:	24	构件重量:	0.38
规格(mm)	RSA50*50*5	长度(mm)	100	共重(kg)	0.38
		数量	1	表面积(m ²)	0.02
		单重(kg)	0.38	合计:	0.38

Rev.	0	第1次设计	2019-01-05
Description			
Date			

PROJECT:
PROPOSED SITE C1
DEVELOPMENT AT AREA A8,
TKOIL 70/2P, TSEUNG KWAN O,
NEW TERRITORIES

CLIENT:
美特鋁質有限公司
MIDI Aluminium Industries Ltd.
Units 6-8, Sunny Industrial Centre, 1/F
610 Che Kwo Ling Road, Kowloon
Tel: 23489211-4 Fax: (852) 27778566

世昌石漆有限公司
SUN CHEUNG PAINTS LIMITED

[ESJ-21]

Designed by	
Drawn by	
Reviewed by	
Approved by	
Scale	
DWGNO: E1	- [ESJ-21]
REV	0

58

M340

SHSS0*50*5.0 x 351

构件: ESJ-22

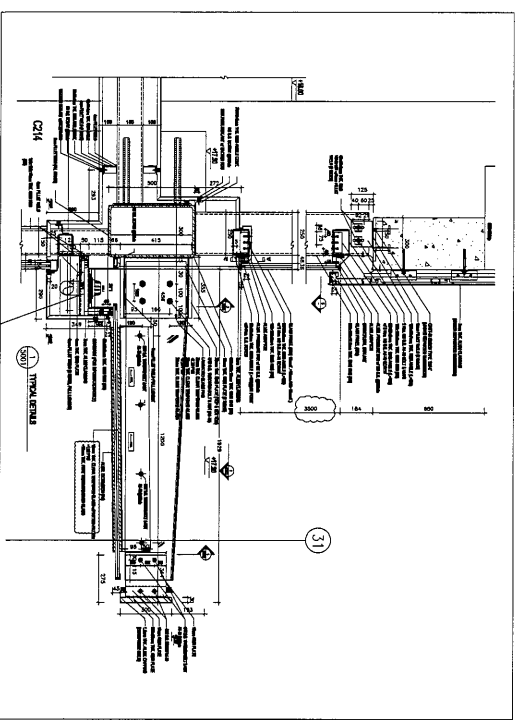

本品

构件编号	规格(mm)	长度(mm)	数量	单重(kg)	共重(kg)	表面积(m ²)
M340	SHSS0*50*5.0	351	1	241	241	0.07
合计:				241		

Rev.	Description	Date
0	第一次提报	2019-01-05

PROJECT: PROPOSED SITE C1
DEVELOPMENT AT KEELAM,
KOTLITOTTAI, SELLING KIVANAO,
NEW TERRITORIES

CLIENT: 美特经贸有限公司
MIDI Aluminium Association Ltd.
Units 6-8, Sunco Industrial Centre, 1/F
610 Cho Kwo Ling Road, Kowloon
Tel: 23489211-4 Fax: (852) 2727656

美特经贸有限公司
MIDI Aluminium Association Ltd.

[ESJ-22]

Designed by	
Drawn by	
Reviewed by	
Approved by	
Scale	
DWGNO.: E1	- [ESJ-22]
REV.	0

59

SHSS0°50'5.0 x 72
M341

构件: ESJ-23

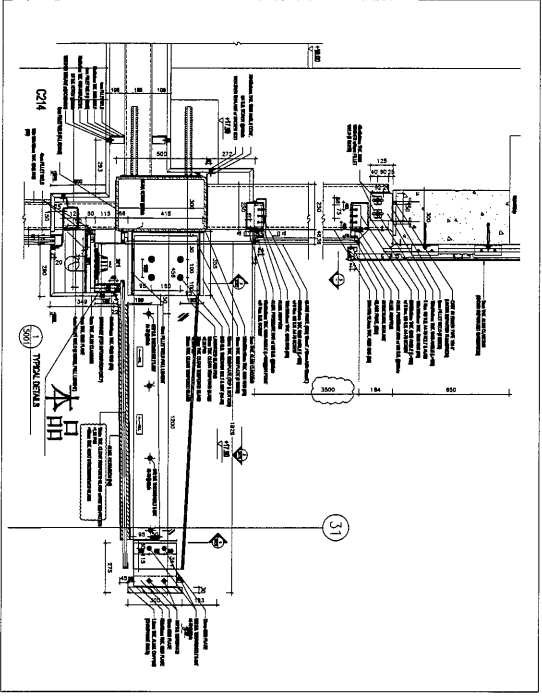

构件编号:	ESJ-23	构件数量:	6	构件重量:	0.49
部件编号	规格(mm)	长度(mm)	数量	单重(kg)	共重(kg)
M341	SHSS0°50'5.0	72	1	0.49	0.49
					表面积(m ²)
					0.01
合计:				0.49	

0	首次描述	2019-01-05
Rev.	Description	Date

PROJECT:
 PROPOSED SITE C1
 DEVELOPMENT AT AREA B8,
 TKOIL TONG TSEUNG KWAN O,
 NEW TERRITORIES

CLIENT:
華特經貿有限公司
 MTDI Development Limited
 Units F-4, Sunco Industrial Centre II/
 510 Che Kwo Ling Road, Kowloon
 Tel: 23489211-4 Fax: (852) 77275566

華特經貿有限公司
 MTDI Development Limited

DESIGN NO.: E1 - ESJ-23

Designed by	
Drawn by	
Reviewed by	
Approved by	
Scale	
DWG NO.: E1	REV: 0

61

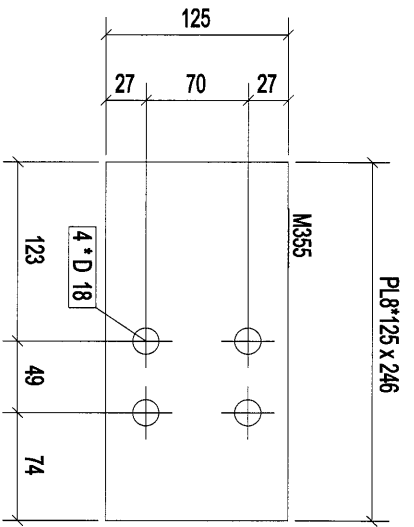

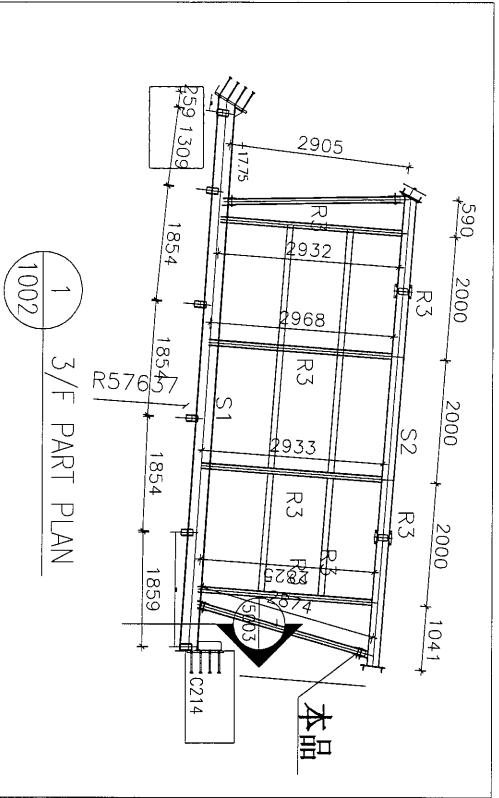

构件: ESJ-25



1
1002
3/4 PART PLAN

构件编号:	ESJ-25	构件数量:	1	构件重量:	1.93
部件编号	规格(mm)	长度(mm)	重量	单重(kg)	表面积(m ²)
M355	PL8*125	246	1	1.93	0.07
合计:			1.93		

Rev:	0	第1次设计	Date:	2019-01-05
PROJECT:	PROPOSED SITE C1 DEVELOPMENT AT KEANG, KUALA LUMPUR, FEDERAL TERRITORIES NEW TERRITORIES			
CLIENT:	 美特经济有限公司 MMDI Architectural Associates Sdn. 610 Cheo Koo Ling Road, Kepong Tel: 23489211-4 Fax: (652) 2727566			
DESIGNED BY:	 捷昌石塔有限公司 IOMAT Limited			
Drawn by:	[ESJ-25]			
Reviewed by:				
Approved by:				
Scale:	1:1			
DWG NO.:	E1	- [ESJ-25]		REV:
				0

62

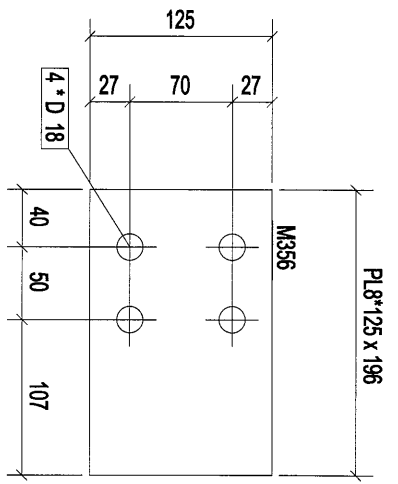

构件: ESJ-26

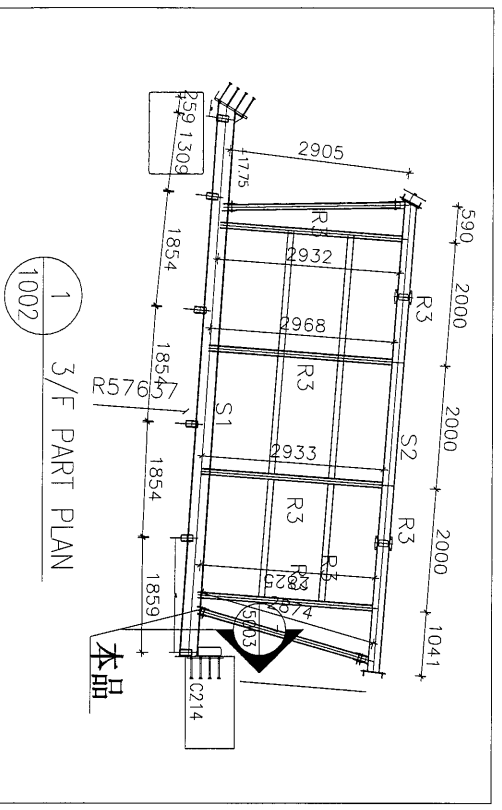

Rev. 0		第一次提批	2019-01-05
Description		Date	
PROJECT: PROPOSED SITE C1 DEVELOPMENT AT AREA 88, KOKILONG TSEUNG KWAN O, NEW TERRITORIES			
CLIENT: 美特經貿有限公司 MTDI AUTUMN WASHSTONE LTD. 610 Chee Koo Ling Road, Kowloon Tel: 23489211-4 Fax: (852) 27277856			
Drawn by		Reviewed by	
Approved by		Scale	
DWG NO: E1		- [ESJ-26]	
REV. 0			

构件编号:	ESJ-26	构件数量:	1	构件重量:	1.54
部件编号	规格(mm)	长度(mm)	数量	单重(kg)	共重(kg)
M356	PL8*125	196	1	1.54	1.54
表面积(m ²)					0.05
合计:					1.54

[ESJ-26]

63

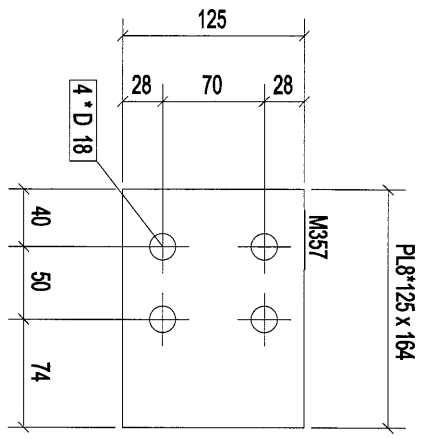

构件: ESJ-27

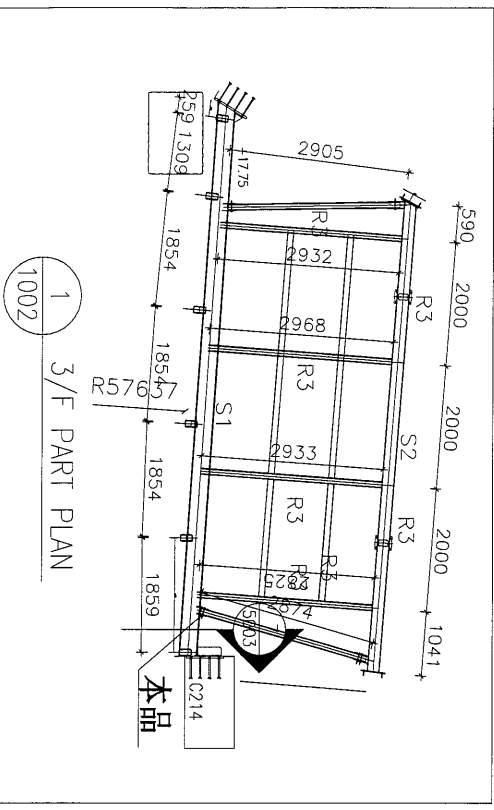

0	第一次提报	2019-01-05
Rev.	Description	Date

PROJECT: PROPOSED SITE C1
DEVELOPMENT AT TSEA 86,
TKO LUN TSEUNG KWAN DO,
NEW TERRITORIES

CLIENT: 美特經貿有限公司
MIDI AUTUMN RESOURCES LTD.
Units 5-8, Sunray Industrial Centre, 1/F
610 Che Kwo Ling Road, Kowloon
Tel: 23489211-4 Fax: (852) 27277656



DESIGNED BY: [ESJ-27]
DRAWN BY: [ESJ-27]
REVIEWED BY: [ESJ-27]
APPROVED BY: [ESJ-27]
SCALE: [ESJ-27]

构件编号:	ESJ-27	构件数量:	1	构件重量:	1.28
规格(mm)	PL8*125	长度(mm)	164	共重(kg)	1.28
数量	1	单重(kg)	1.28	表面积(m ²)	0.05
合计:				1.28	

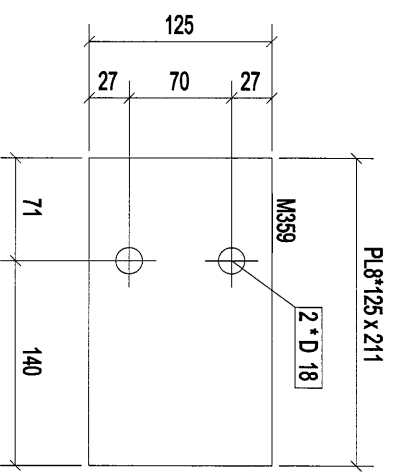

DMG NO:	E1	REV:	0
	- [ESJ-27]		

65

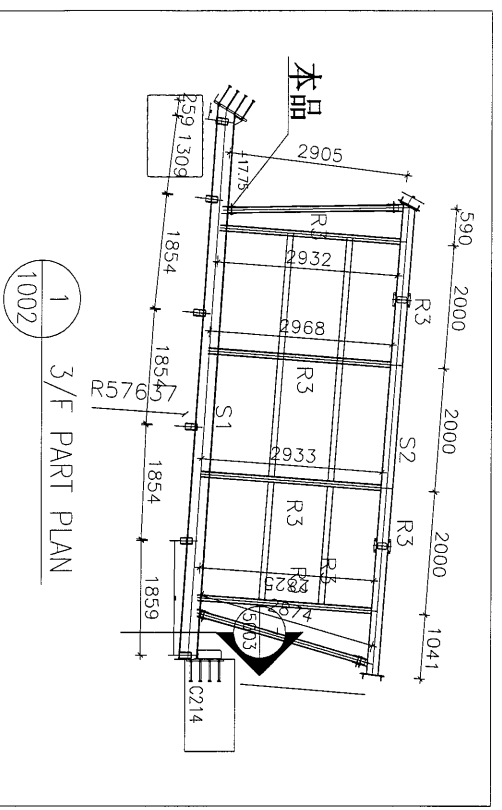

构件: ESJ-29



Rev:	0	第一次批准	2019-01-05
Description:	PROPOSED SITE C1 DEVELOPMENT AT AREA NO. TWO/TWO/F, TSEUNG KWANLO, NEW TERRITORIES		
CLIENT:	 美特鋁質有限公司 MIDU Aluminium Associates Ltd. Units 6-8, Sunny Industrial Centre, 1/F, 610 Chee Kwo Ling Road, Kwailoon Tel: (852) 4892711-4 Fax: (852) 7727666		
PROJECT:	 捷昌石礦有限公司 GSD Stone Limited		
Designed by	[ESJ-29]		
Drawn by			
Reviewed by			
Approved by			
Scale			
DWGNO:	E1	- [ESJ-29]	REV: 0

构件编号:	ESJ-29	构件数量:	1	构件重量:	1.66
规格(mm)	PL8*125	长度(mm)	211	共重(kg)	1.66
数量	1	单重(kg)	1.66	表面积(m ²)	0.06
合计:				1.66	

28

RSAT5756 x 1749

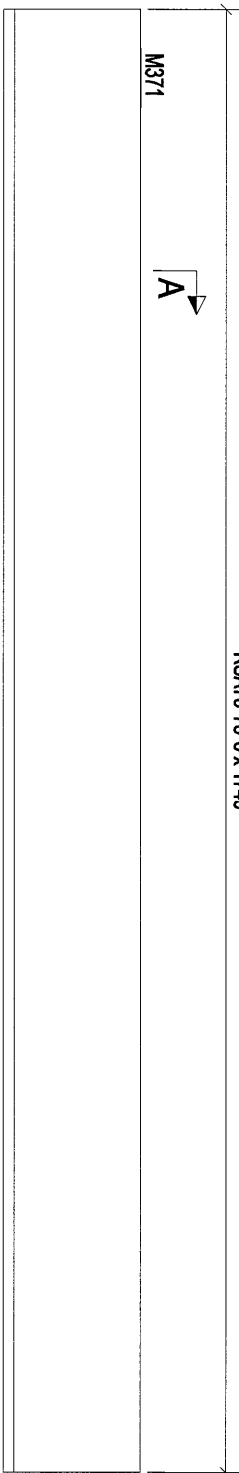

构件: ESJ-32

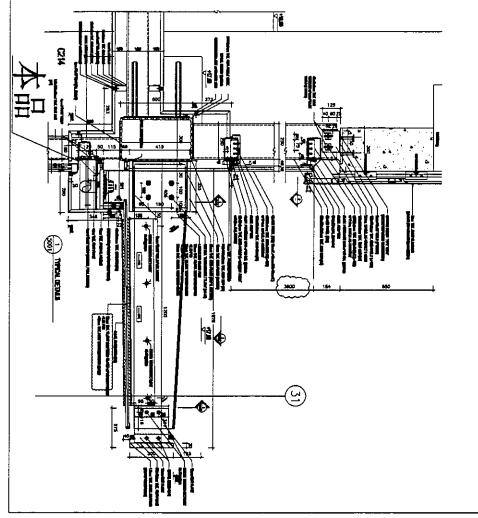
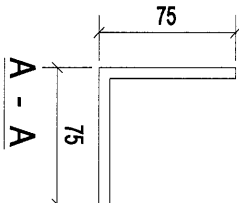

构件编号	规格(mm)	长度(mm)	数量	单重(kg)	共重(kg)	表面积(m ²)
M371	RSAT5756	1749	1	11.87	11.87	0.53
构件数量:			3	构件重量:		
ESJ-32				11.87		
合计:				11.87		

0	第一次提报	2019-01-05
Rev:	Description	Date

PROJECT: PROPOSED SITE C1
DEVELOPMENT AT ANEAK, KOTLITOTI, TSEUNG KWAN O, NEW TERRITORIES

CLIENT: 基特經貿有限公司
MIDI Automate Associates Ltd.
Units 6-8, Sunny Industrial Centre, 1/F,
610 Chee Kwo Ling Road, Kowloon
Tel: (852) 489211-4 Fax: (852) 27272666

捷昇石礦有限公司
GSI Limited

[ESJ-32]

Designed by	
Drawn by	
Reviewed by	
Approved by	
Scale	
DWGNO: E1	- [ESJ-32]
REV	0

RSA75*75*6 x 1694

M372



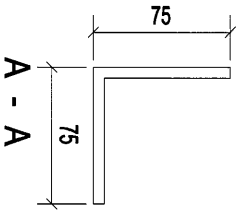

构件: ESJ-33

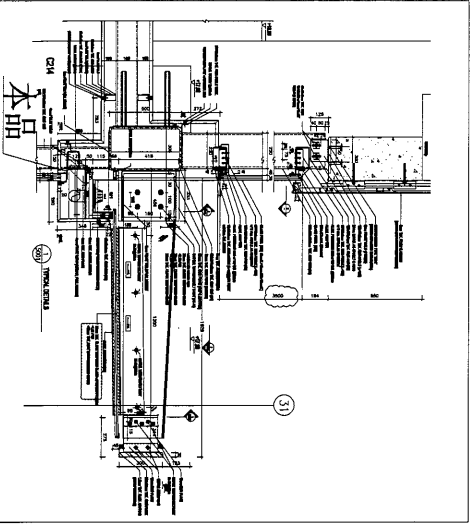

69



构件编号	规格(mm)	长度(mm)	数量	单重(kg)	共重(kg)	表面积(m ²)
M372	RSA75*75*6	1694	1	11.49	11.49	0.51
合计:				11.49		

Rev.	0	第1次设计	2019-01-05
PROJECT:	PROPOSED SITE C1 DEVELOPMENT AT LARSA #6, TOTTORI-TSUNOBU KAWANO, NEW TERRITORIES		
CLIENT:	 美特经貿有限公司 MIDI Automotive Associates Ltd. Units 6-8, Sunny Industrial Centre, 1/F 610 Chee Kwo Ling Road, Kowloon Tel: (852) 489211-4 Fax: (852) 27278666		
DESIGNED BY	 捷昇石隆公司 JI SHENG LOAN LIMITED		
Drawn by	[ESJ-33]		
Reviewed by			
Approved by			
Scale	1:1		
DWG NO.	E1	-	[ESJ-33]
REV.	0		

70

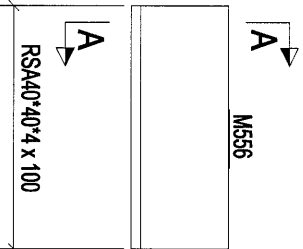

构件: ESJ-34

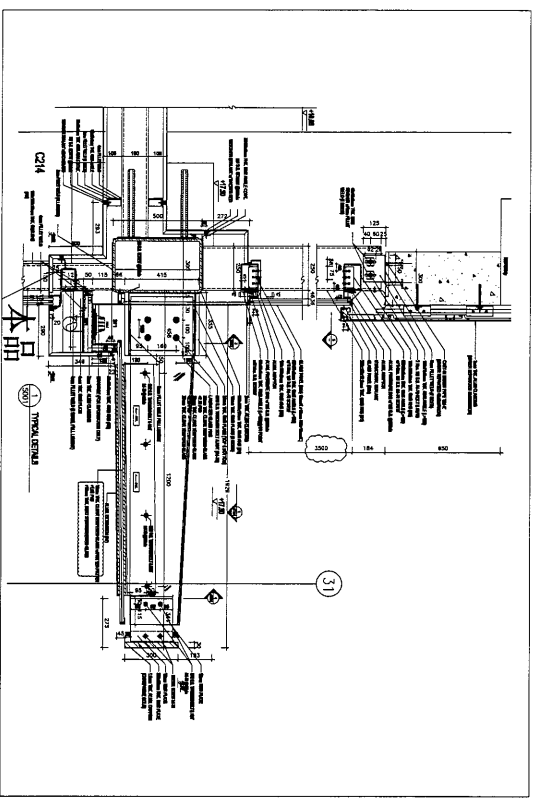
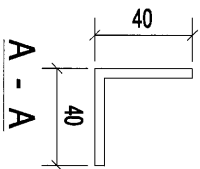

构件编号	规格(mm)	长度(mm)	数量	单重(kg)	共重(kg)	表面积(m ²)
M556	RSA40*40*4	100	1	0.24	0.24	0.02
构件数量: 28			构件重量: 0.24			
合计:			0.24			

0	第一次设计	2019-01-05
Rev.	Description	Date

PROJECT: PROPOSED SITE C1
DEVELOPMENT AT ANEAK,
KOTLITOTI, ISENGS KWANAO,
NEW TERRITORIES

CLIENT: 基特經貿有限公司
MIDI Architecture Associates Ltd.
Units 6-8, Sunray Industrial Centre, 1/F
610 Chee Kwo Ling Road, Kowloon
Tel: 23489211-4 Fax: (852) 27272668

设计有限公司
设计有限公司

[ESJ-34]

Designed by	
Drawn by	
Reviewed by	
Approved by	
Scale	
DWG NO.: E1	- [ESJ-34]
REV.	0

71

RSA/75*75*6 x 1203

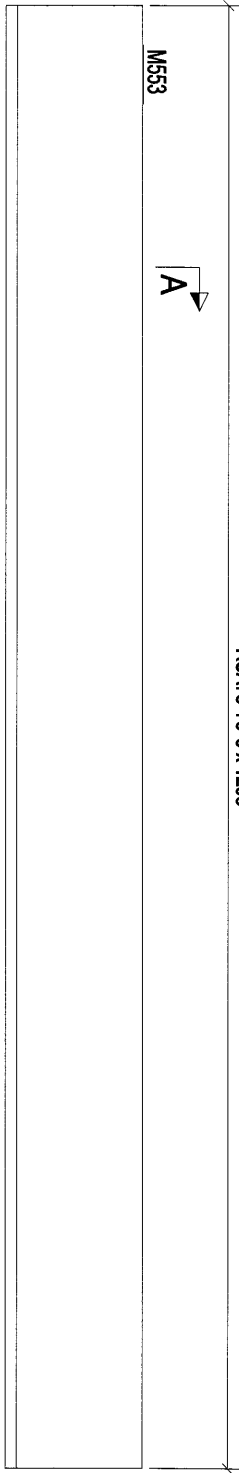

构件: ESJ-35

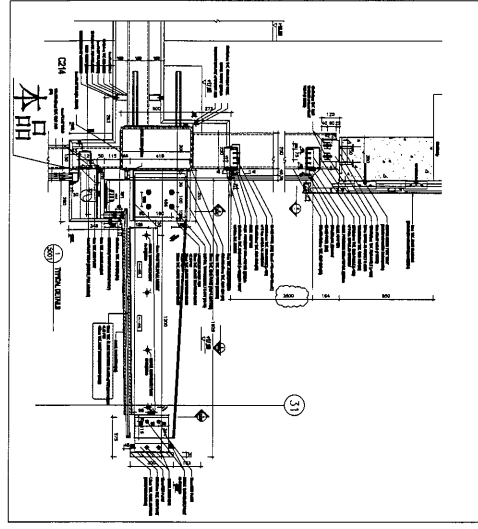
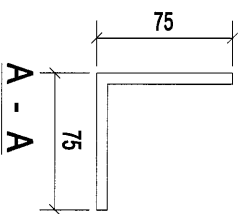

构件编号	规格(mm)	长度(mm)	数量	单重(kg)	共重(kg)	表面积(m ²)
M553	RSA/75*75*6	1203	1	8.16	8.16	0.36
合计:				8.16		

Rev.	第几次修改	Date
0		2019-01-05

PROJECT: PROPOSED SITE C1
DEVELOPMENT AT AREA 88,
KOTLORP, TSEUNG KWAN O,
NEW TERRITORIES

CLIENT: 美特經貿有限公司
MIDI Architecture & Interiors
Units 5-8, Sunny Industrial Centre, 1/F
610 Chee Koo Ling Road, Kowloon
Tel: 23489211-4 Fax: (852) 27272566

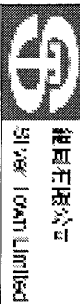

權臣石隆公司
SHI YONG LIMITED

Designated by	Reviewed by	Approved by	Scale	DWG NO.	REV.
				E1	0

[ESJ-35]

72

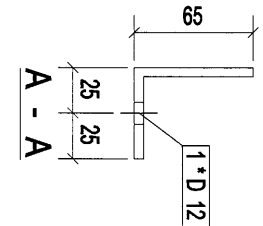
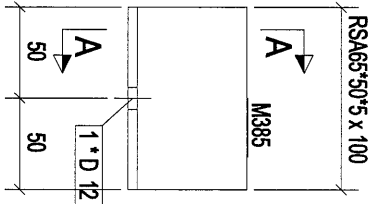

构件: ESJ-36

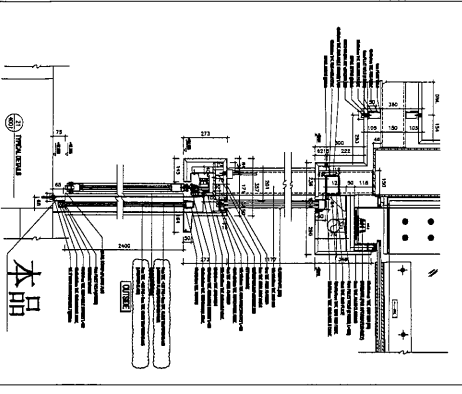

构件编号:	ESJ-36	构件数量:	12	构件重量:	0.44
规格(mm)	RSA65*50*5	长度(mm)	100	共重(kg)	0.44
数量	1	单重(kg)	0.44	表面积(m ²)	0.02
合计:				0.44	

Rev.	0	第1次设计	2019-01-05
Description			
Date			

PROJECT: PROPOSED SITE C1 DEVELOPMENT AT AREA 88, T'KOTI 70/RP TSEUNG KWAN O, NEW TERRITORIES

CLIENT: 美特經貿有限公司
MIDI AGENSIA PUSAKANS sdn. bhd.
Units 6-8, Sunray Industrial Centre, 1/F
610 Chee Kwo Ling Road, Kwailoon
Tel: 23489211-4 Fax: (852) 27276566

捷日工程公司
G.P. ENGINEERING LIMITED

[ESJ-36]

Designed by	
Drawn by	
Reviewed by	
Approved by	
Scale	
DWGNO: E1	- [ESJ-36]
REV	0

73

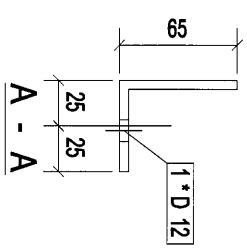
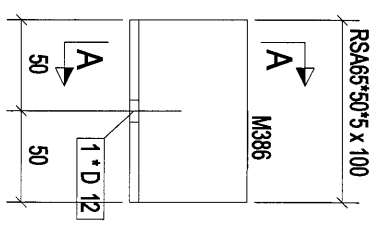

构件: ESJ-37

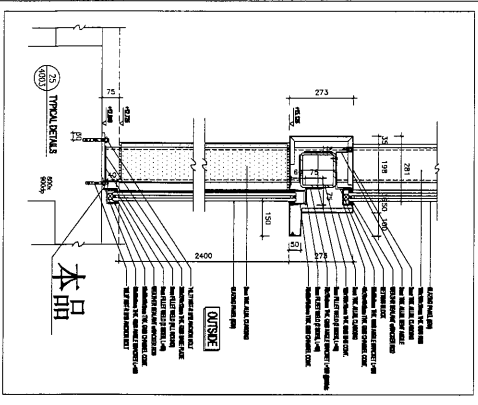

Rev.	0	第一次提批	2019-01-05
PROJECT:	PROPOSED SITE C1 DEVELOPMENT AT AREA 88, TOKI TORI, TSEUNG KWAN O, NEW TERRITORIES		
CLIENT:	 三井物産株式会社 Mitsui Bussan Kaisha Ltd. Unit 5-8, Sunny Industrial Centre, 1/F 610 Chee Koo Ling Road, Kowloon Tel: 23489211-4 Fax: (852) 27275656		
Drawn by	Designed by		
Reviewed by	Approved by		
Scale	Scale		
DWG NO: E1	- ESJ-37		REV: 0

构件编号:	ESJ-37	构件数量:	3	构件重量:	0.44
规格(mm)	100	数量	1	共重(kg)	0.44
长度(mm)	100	单重(kg)	0.44	表面积(m ²)	0.02
M396	RS465*50*5	数量	1	共重(kg)	0.44
合计:		数量	0.44	共重(kg)	0.44

75

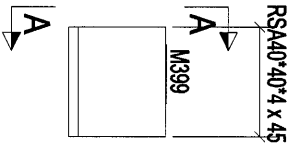

构件: ESJ-39

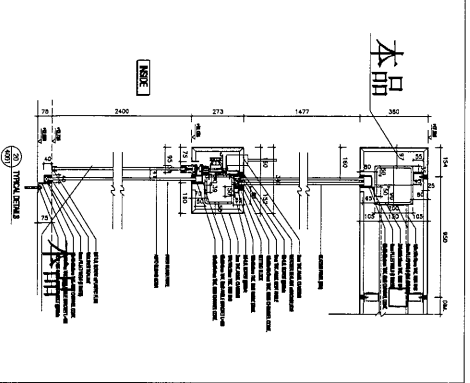
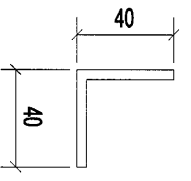

构件编号:	ESJ-39	构件数量:	8	构件重量:	0.11	表面积(m ²):	0.01
部件编号	规格(mm)	长度(mm)	数量	单重(kg)	共重(kg)	表面积(m ²)	
M399	RSA40*40*4	45	1	0.11	0.11	0.01	
合计:				0.11			

Rev.	0	第1次提报	2019-01-05
Description			

PROJECT: PROPOSED SITE C1
DEVELOPMENT AT AREA 08,
KOTILTON TSEUNG KWAN O,
NEW TERRITORIES

CLIENT: 美特經貿有限公司
MIDI ALUMINIUM EXTRUSION LTD.
Units 5-8, Sunco Industrial Centre, 1/F,
610 Chee Koo Ling Road, Kowloon
Tel: 23489211-4 Fax: (852) 27272666

设计有限公司
DESIGN LIMITED

[ESJ-39]

Designed by	
Drawn by	
Reviewed by	
Approved by	
Scale	
DWGNO: E1	- [ESJ-39]
REV	0

76

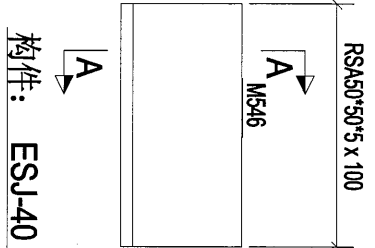

构件: ESJ-40

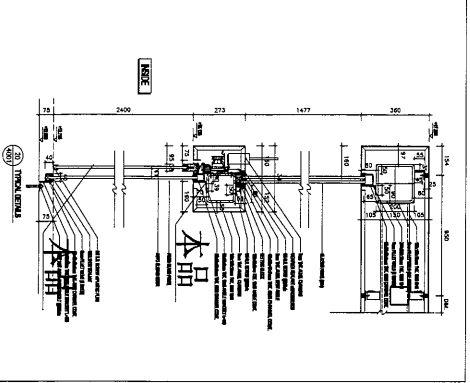

构件编号	规格(mm)	长度(mm)	数量	单重(kg)	共重(kg)	表面积(m ²)
ESJ-40	RSAS50*50*5	100	13	0.38	0.38	0.02
合计:				0.38		

Rev.	修改/描述	Date
0		2019-01-05

PROJECT: PROPOSED SITE C1
DEVELOPMENT AT AREA 68,
TWO LUNG TSEUNG KWAN O,
NEW TERRITORIES

CLIENT: 美特鋸業有限公司
MIDI AUTUMN PAPERWORKS LTD.
Units 6-8, Sunny Industrial Centre, 1/F,
610 Chee Koo Ling Road, Kowloon
Tel: 23489211-4 Fax: (852) 2727666



總代理: 美特鋸業有限公司
MIDI AUTUMN PAPERWORKS LTD.

DESIGNED BY: [ESJ-40]

DMGNO.	REV.
E1	0

77

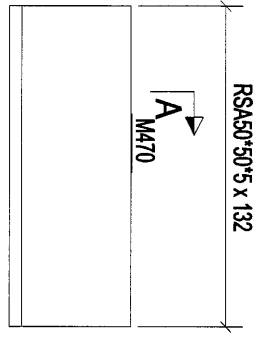

构件: ESJ-41

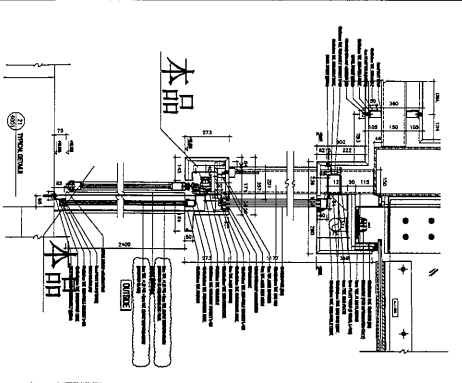
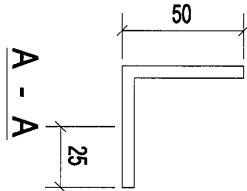

0	第一次提报	2019-01-05
Rev.	Description	Date

PROJECT: PROPOSED SITE C1
DEVELOPMENT AT AREA 86,
TKO LUN TSEUNG KWAN O,
NEW TERRITORIES

CLIENT: 美特经贸有限公司
MIDI INTERNATIONAL LIMITED
Units 5-8, Sunray Industrial Centre, 1/F,
610 Che Kwo Ling Road, Kowloon
Tel: 23489211-4 Fax: (852) 27277856



设计人: 程石路
设计日期: 2019-01-05

构件编号	ESJ-41	构件数量	12	构件重量	0.50
规格(mm)	RSAS0*50*5	数量	1	失重(kg)	0.50
长度(mm)	132	单重(kg)	0.50	表面积(m ²)	0.03
M470	RSAS0*50*5	合计:	0.50		

Designed by	
Drawn by	
Reviewed by	
Approved by	
Scale	
DWGNO: E1	- [ESJ-41]
REV	0

78

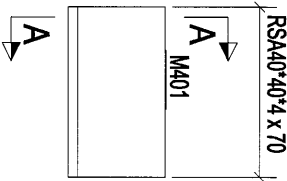

构件: ESJ-42

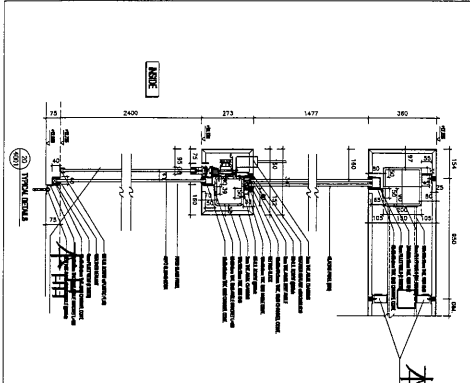
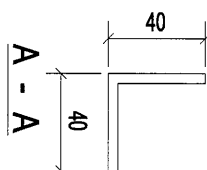

本品

构件编号:	ESJ-42	构件数量:	36	构件重量:	0.17
部件编号	规格(mm)	长度(mm)	数量	单重(kg)	共重(kg)
M401	RS440*40*4	70	1	0.17	0.17
					表面积(m ²)
					0.01
合计:				0.17	

0	第一次提批	2019-01-05
Rev.	Description	Date

PROJECT: PROPOSED SITE C1
DEVELOPMENT AT ANEA NO.
TKO L'ORFÈS/SEUNG KWAN O.
NEW TERRITORIES

CLIENT: 美特經貿有限公司
MIDI Architecture Associates Ltd.
Units 6-8, Sunray Industrial Centre, 1/F
610 Chee Kwo Ling Road, Kowloon
Tel: 23489211-4 Fax: (852) 27275656

美特經貿有限公司
MIDI Architecture Associates Ltd.

[ESJ-42]

Designed by	
Drawn by	
Reviewed by	
Approved by	
Scale	
DWG NO: E1	- [ESJ-42]
REV	0

80

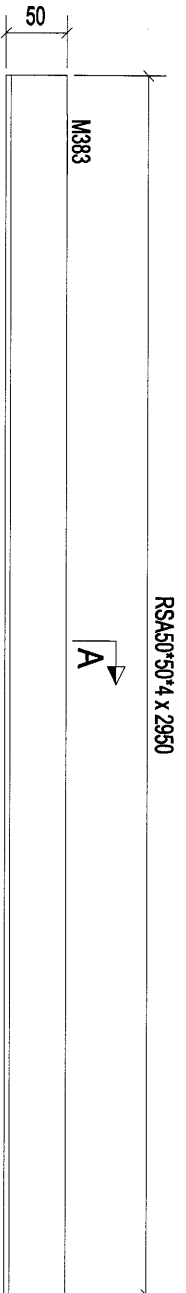

构件: JT-1

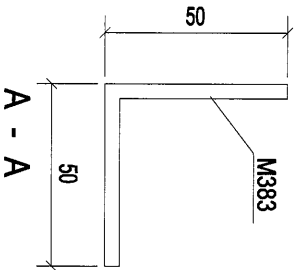

本品

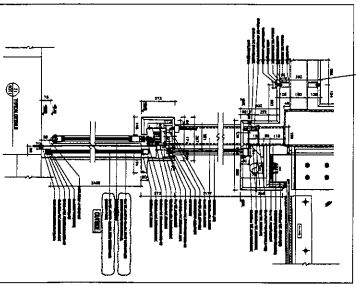

构件编号	规格(mm)	长度(mm)	数量	单重(Kg)	共重(Kg)	表面积(m ²)
M383	RSA50*50*4	2950	1	9.08	9.08	0.56
构件数量: 20		构件重量: 9.08		表面积: 0.56		
合计: 9.08						

Rev.	第几次修改	Date
A	第一次修改	2019-01-05

PROJECT: PROPOSED SITE C1
DEVELOPMENT AT AREA 88,
TKOIL TONK, TSEUNG KWAN O,
NEW TERRITORIES

CLIENT: 美特堅實有限公司
MIDI Architecture / Interceptor Ltd.
Units 6-8 Sunny Industrial Centre,
610 Chee Kwo Ling Road, Kowloon
Tel: 23469211-4 Fax: (852) 27272656

總商標有限公司
MIDY | OYAMT Limited

[JT-1]

Designed by	
Drawn by	
Reviewed by	
Approved by	
Scale	
DWG NO: E1	- [JT-1]
REV	A

82

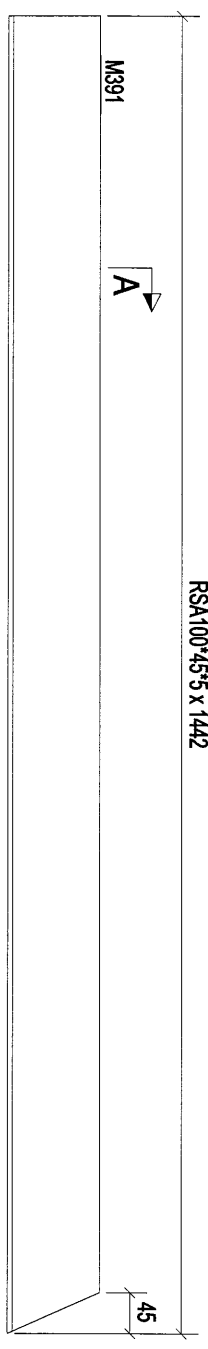

RSA100*45*5 x 1442

构件: JT-9

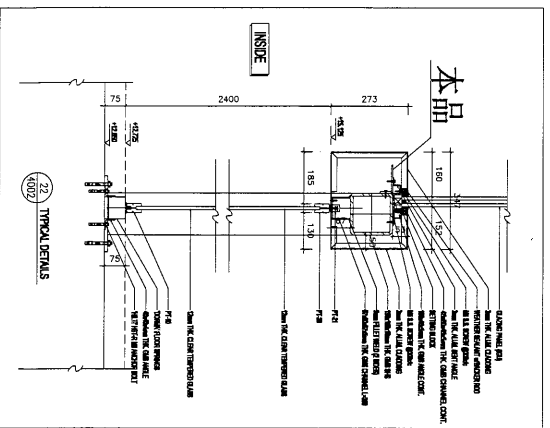
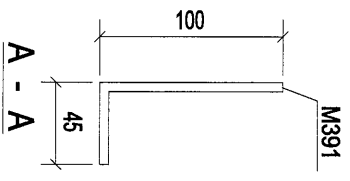

构件编号	规格(mm)	长度(mm)	数量	单重(kg)	共重(kg)	表面积(m ²)
M391	RSA100*45*5	1442	1	7.83	7.83	0.41
构件数量:			1	构件重量:		
JT-9				7.83		
合计:				7.83		

Rev.	修改描述	Date
0		2019-01-05

PROJECT: PROPOSED SITE C1
DEVELOPMENT AT AREA 68,
KOTI LON TSEUNG KWAN O,
NEW TERRITORIES

CLIENT: 美特經貿有限公司
MIDI Aluminium Fabrication Ltd.
Units 5-8, Sunny Industrial Centre, 1/F,
610 Chi Kuo Ling Road, Kowloon
Tel: 23448921-4 Fax: (852) 27277656



搜星石有限公司
SEARCHSTAR Limited

Drawn by	Reviewed by	Approved by	Scale	DWG NO.	REV
				E1	0

[JT-9]

83

RSA100*45*5 x 2051

M392



构件: JT-10

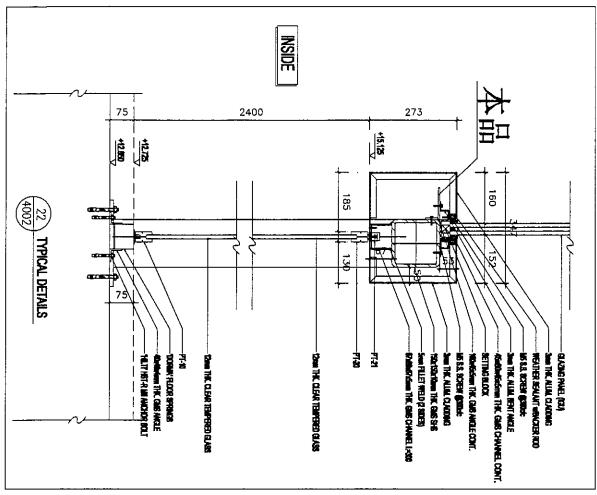
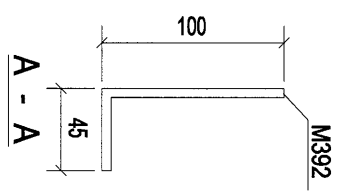

构件编号	规格(mm)	长度(mm)	数量	单重(kg)	构件重量	表面积(m ²)
M392	RSA100*45*5	2051	1	11.25	11.25	0.80
合计:					11.25	

Rev.	0	第一次提报	2019-01-05
PROJECT:	PROPOSED SITE C1 DEVELOPMENT AT YEAP A6, TLOT 10/P/ TSEUNG KWAN O, NEW TERRITORIES		
CLIENT:	美特經貿有限公司 MIDI Advertising Associates Ltd. Units 6-8, Sunray Industrial Centre, 1/F 510 Che Kwo Ling Road, Kowloon Tel: 23489211-4 Fax: (852) 27727566		
Designed by	[JT-10]		
Drawn by			
Reviewed by			
Approved by			
Scale	1:1		
DWGNO.	E1	- [JT-10]	REV 0

86

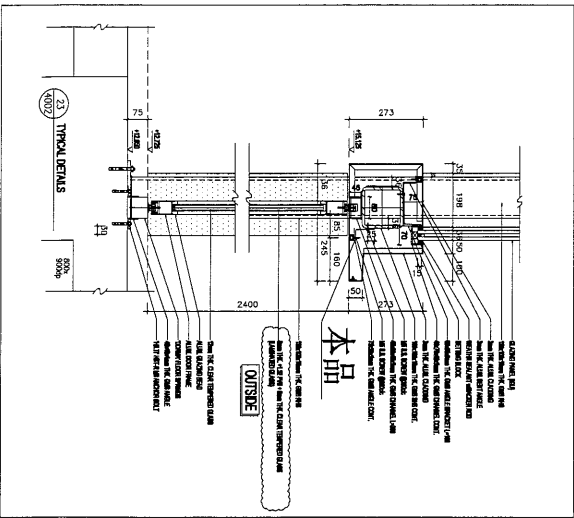
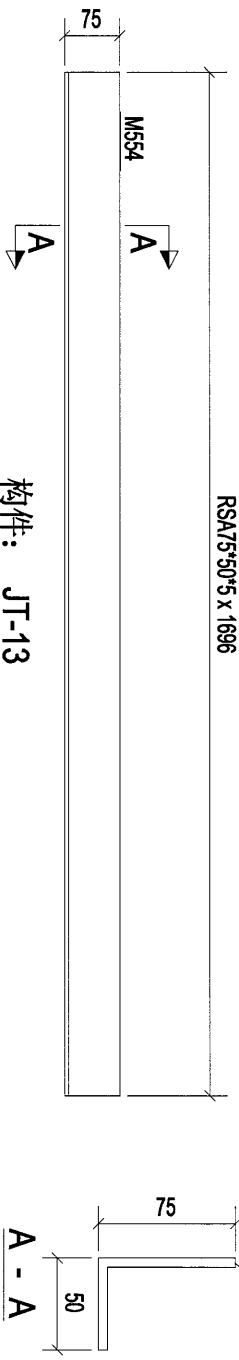

Rev.	0	第1次设计	2019-01-05
Description	PROJECT: PROPOSED SITE C1 DEVELOPMENT AT ABEA RD, T'KOTI TORP, TSEUNG KWAN O, NEW TERRITORIES		

CLIENT: 美特經貿有限公司
MIDI AUSTRALIAN ASSURANCE LTD.
Units 5-8, Sunray Industrial Centre, 1/F,
610 Che Kwo Ling Road, Kowloon
Tel: 23489211-4 Fax: (852) 27727656

美特經貿有限公司
MIDI AUSTRALIAN ASSURANCE LTD.
Units 5-8, Sunray Industrial Centre, 1/F,
610 Che Kwo Ling Road, Kowloon
Tel: 23489211-4 Fax: (852) 27727656

[JT-13]

构件编号:	JT-13	构件数量:	1	构件重量:	7.99	表面积(m ²):	0.43
部件编号	规格(mm)	长度(mm)	数量	单重(kg)	共重(kg)	表面积(m ²)	
M554	RSA75*50*5	1696	1	7.99	7.99	0.43	
合计:				7.99			

Designed by	
Drawn by	
Reviewed by	
Approved by	
Scale	
DWGNO: E1	- [JT-13]
REV:	0

87

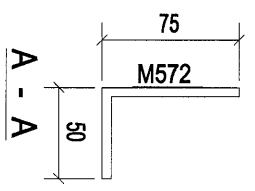
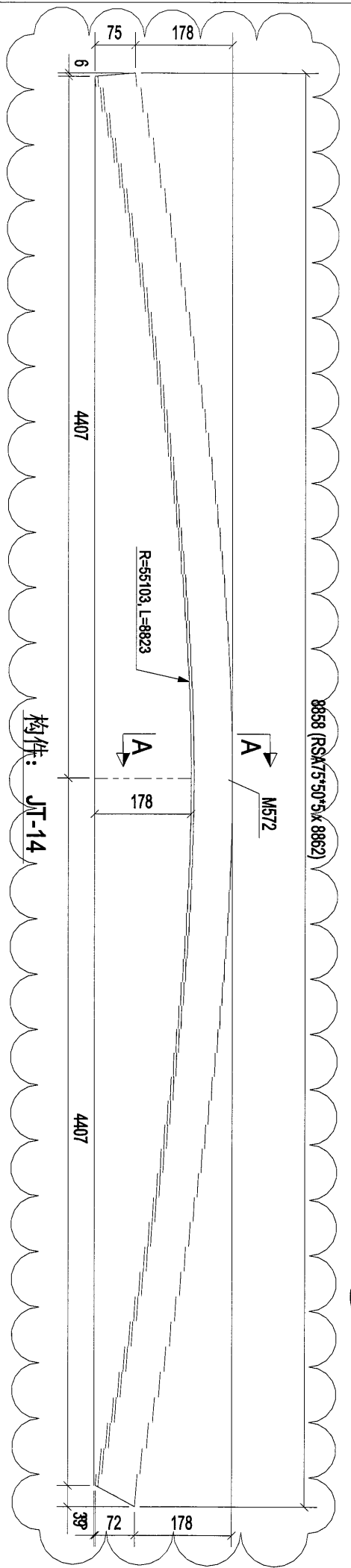

OK

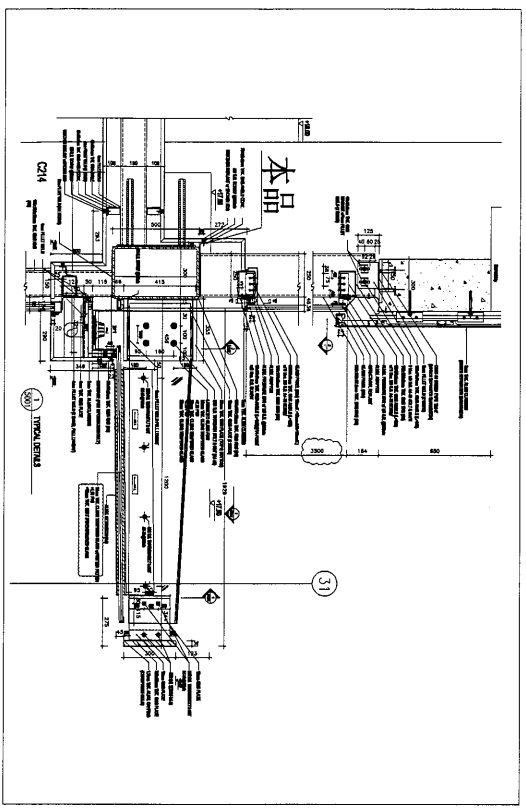

构件编号:	JT-14	构件数量:	1	构件重量:	41.83
部件编号	规格(mm)	长度(mm)	数量	单重(kg)	共重(kg)
M572	RSN75*50*5	8862	1	41.83	41.83
合计:				41.83	2.21

A	首次设计	2019-01-05
Rev.	Description	Date

PROJECT: PROPOSED SITE C1
DEVELOPER: AT TERAH, TOLL TOWER, SENG KIAN O, NEW TERRITORIES

CLIENT: 美特经贸有限公司
MIDI AUSTRALIA PTY LTD
Units 6-8, Sunray Industrial Centre, 1/F
610 Chai Kwo Ling Road, Kowloon
Tel: 23489211-4 Fax: (852) 2772656

设计有限公司
SINCE 1987 Limited

[JT-14]

Designed by	
Drawn by	
Reviewed by	
Approved by	
Scale	
DWG NO: E1	- JT-14]
REV	A

88

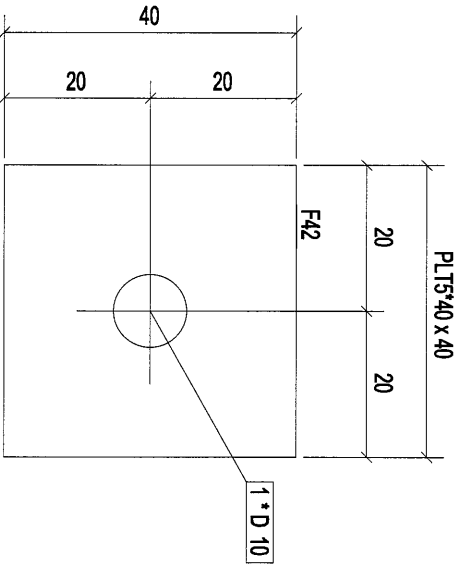

构件: P5

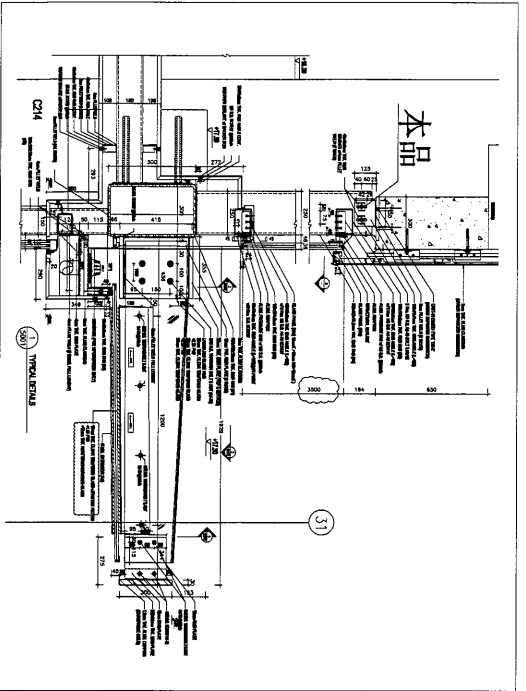

构件编号	规格(mm)	长度(mm)	数量	单重(kg)	共重(kg)	表面积(m ²)
F42	PLTS*40	40	1	0.06	0.06	0.00
合计:			24	0.06	0.06	0.00

Rev.	0	首次提报	2019-01-05
Description	PROJECT: PROPOSED SITE C1 DEVELOPMENT AT AREA A8, KOTLON/TSEUNG KWAN O, NEW TERRITORIES		
CLIENT:	 美特经贸有限公司 MIDT Advertising & Marketing Ltd. Units 5-8, Sunny Industrial Centre, 1/F 610 Chee Kwo Ling Road, Kowloon Tel: 23489211-4 Fax: (852) 27275656		
Designed by	[P.5]		
Drawn by			
Reviewed by			
Approved by			
Scale	1:1		
DWGNO.	E1	-	[P.5]
REV.	0		

89

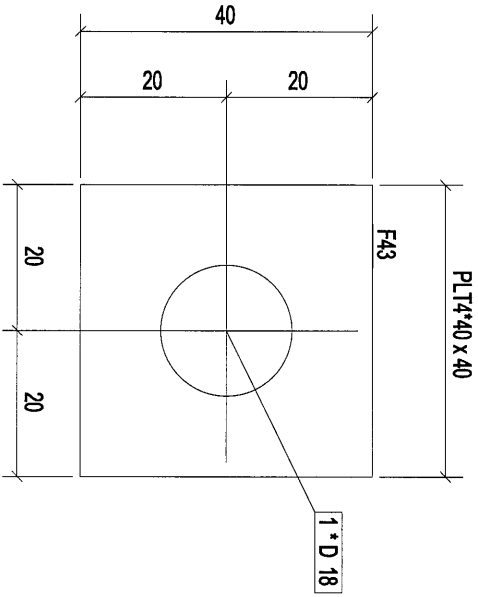

构件: P6

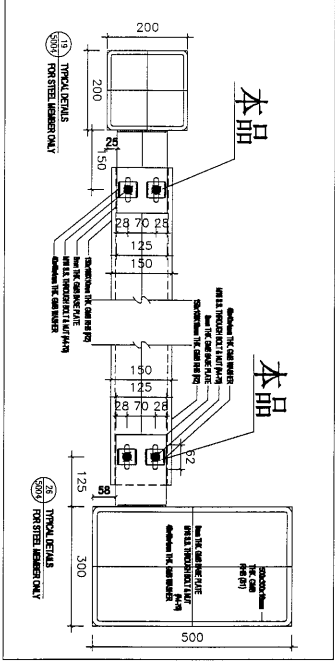

构件编号	规格(mm)	长度(mm)	数量	单重(kg)	共重(kg)	表面积(m ²)
F43	PLT4*40	40	1	0.05	0.05	0.00
合计:			24	0.05	0.05	0.00

Rev.	0	修改日期	2019-01-05
Description	PROJECT: PROPOSED SITE C1 DEVELOPMENT AT AREA 88, TSOIL TON P. TSEUNG KWAN O, NEW TERRITORIES		
Client	 美特銘實有限公司 MIDI Investment Management Ltd. 610 Che Kwo Ling Road, Kowloon Tel: 2389211-4 Fax: (852) 2727266		
Designed by	[P.6]		
Drawn by			
Reviewed by			
Approved by			
Scale			
DWG NO.	E1	-	[P.6]
REV	0		

90

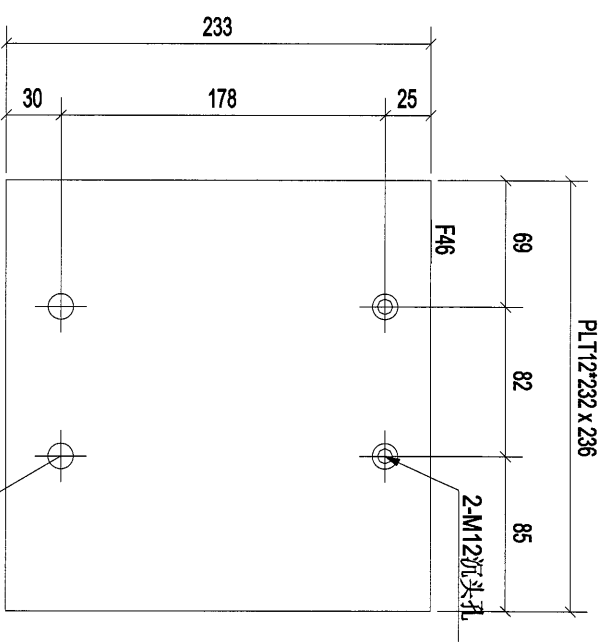

构件: P7
 此件全件喷油, 添灰,
 TUC51602XL(RV-3)

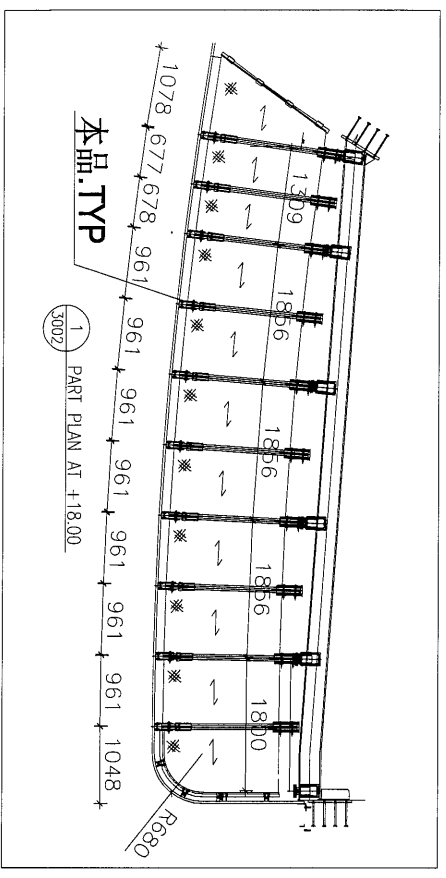

构件编号	规格(mm)	长度(mm)	数量	重量(kg)	共重(kg)	表面积(m ²)
F46	PL T12*232*8	236	1	5.18	5.18	0.12
合计:				5.18	5.18	0.12

Rev.	A	第2次跟进	2019-01-05
PROJECT:	PROPOSED SITE C1 DEVELOPMENT AT KEA KOK, KOKIL TOPI, TSEMING KWAN O, NEW TERRITORIES		
CLIENT:	 華特經貿有限公司 MIDI (Malaysia) Sdn Bhd Units 6-8, Sunway Industrial Centre, 1/F, 610 Cheong Koo Ling Road, Kelantan Tel: 23489211-4 Fax: (852) 27277666		
DESIGNED BY:	[P.7]		
DRAWN BY:			
REVIEWED BY:			
APPROVED BY:			
SCALE:	1:1		
DWG NO.:	E1	-	P.7
REV.	A		

RHS250*150*12.5 x 3931

3462

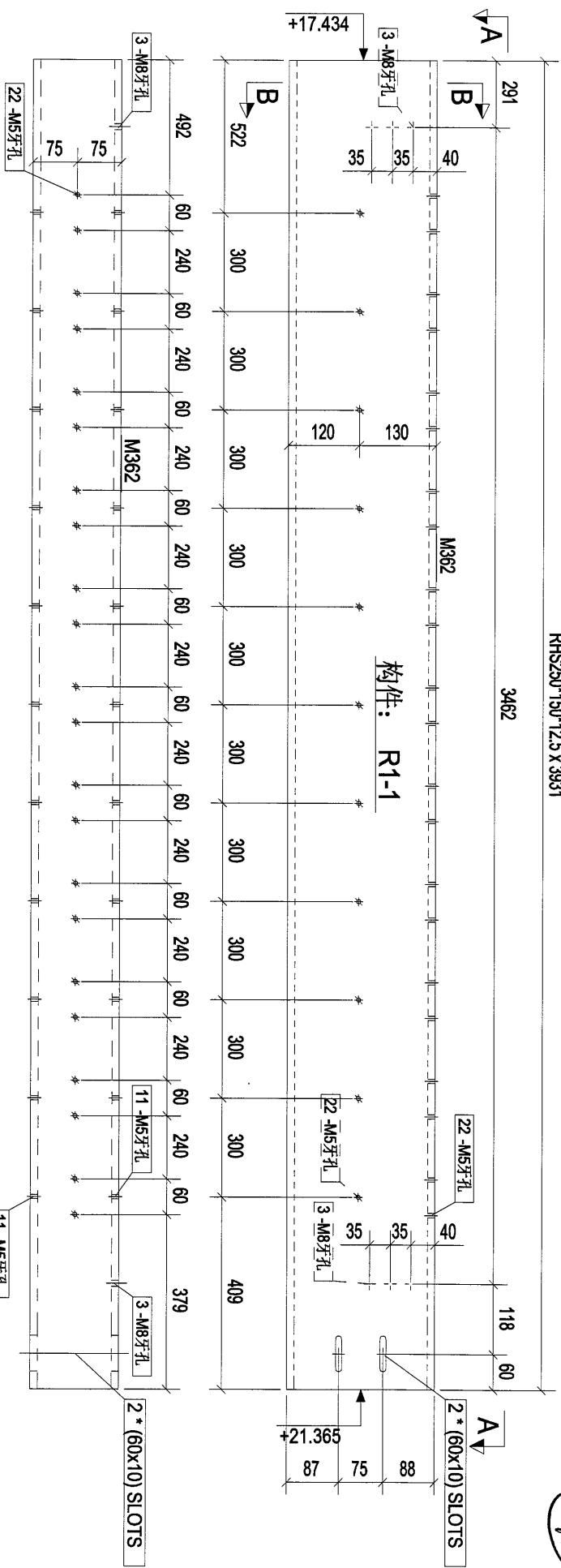

A - A

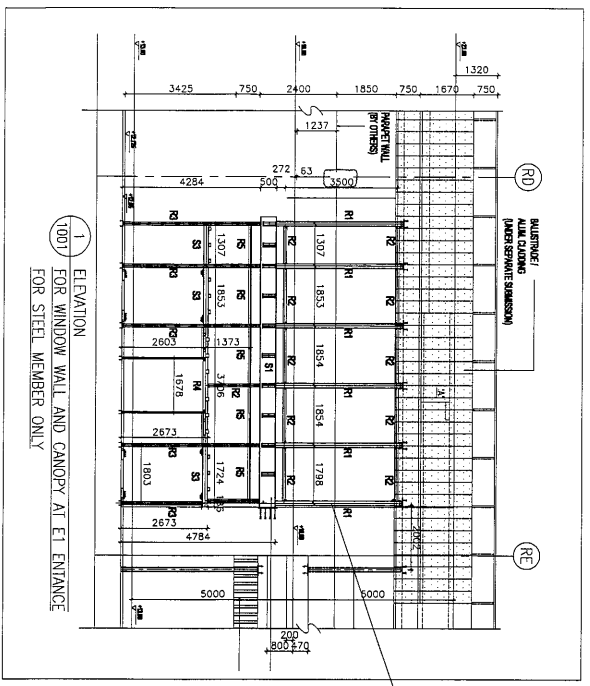
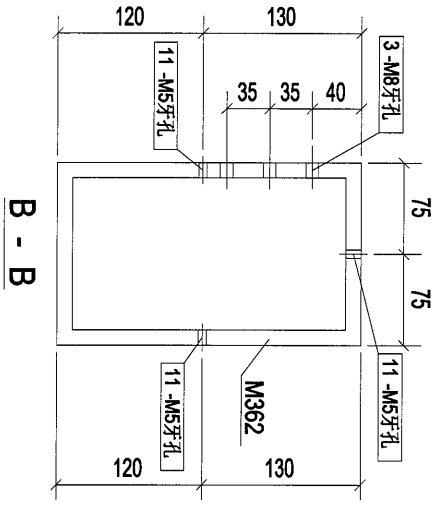

本品

构件编号:	R1-1	构件数量:	1	构件重量:	294.22
部件编号	规格(mm)	长度(mm)	数量	单重(kg)	共重(kg)
M362	RHS250*150*12.5	3931	1	294.22	294.22
合计:					294.22
					表面积(m ²)
					3.02

Rev.	Description	Date
A	第2次报批	2019-01-05

PROJECT: PROPOSED SITE C1 DEVELOPMENT AT AREA 88, TIKOIL TOWER, TSEUNG KWAN O, NEW TERRITORIES

CLIENT: 華特經貿有限公司
MIDI International (HK) Ltd.
Units 6-B, Sunny Industrial Centre, 1/F
610 Chee Kwo Ling Road, Kowloon
Tel: 23489211-4 Fax: (852) 27727656



[R1-1]

Designed by	
Drawn by	
Reviewed by	
Approved by	
Scale	
DWG NO: EI	- [R1-1]
REV	A

91

RHS250*150*12.5 x 3931

92

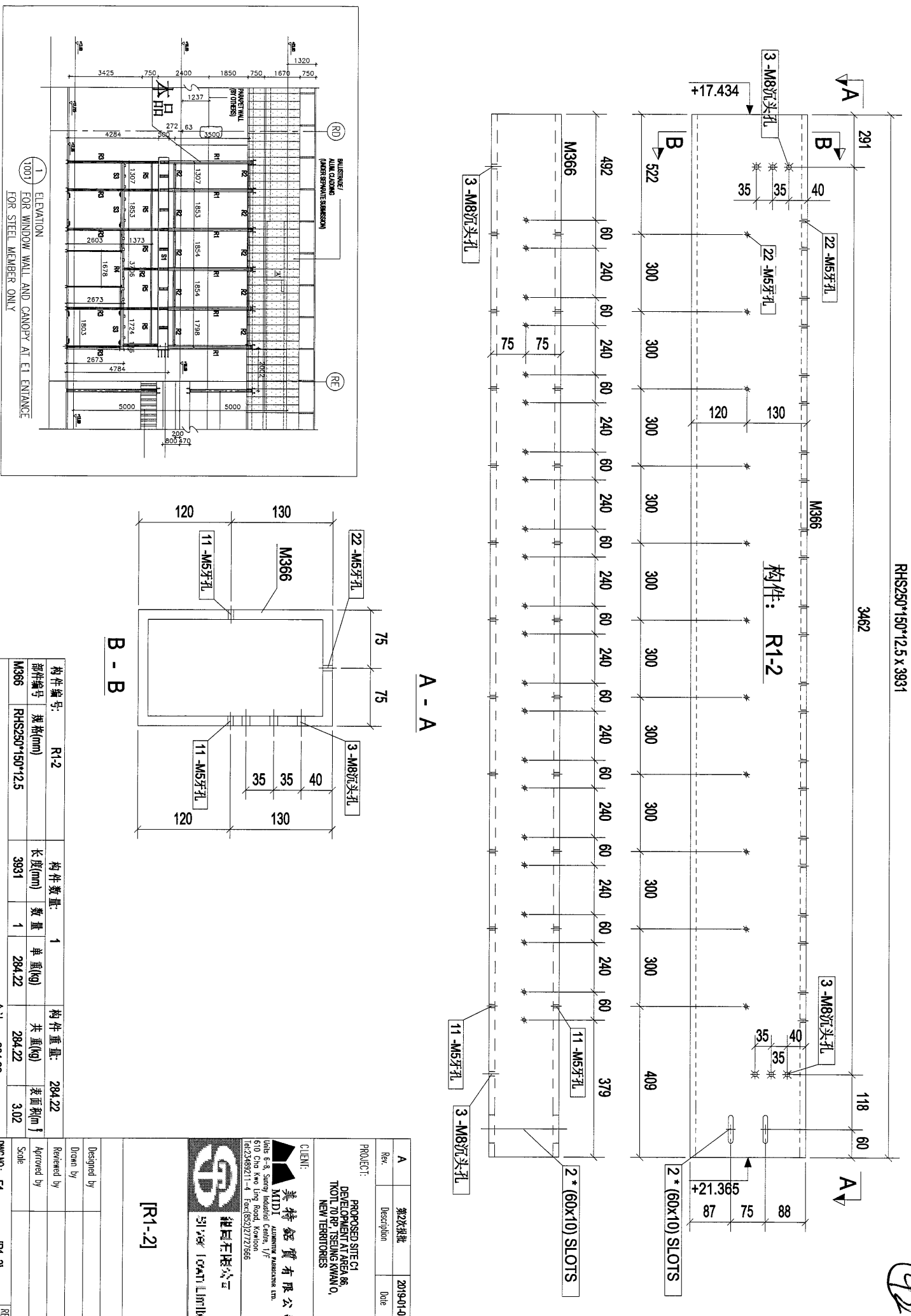

构件: R1-2

A - A

B - B

构件编号: R1-2		构件数量: 1		构件重量: 284.22	
部件编号	规格(mm)	长度(mm)	数量	单重(N)	共重(N)
M366	RHS250*150*12.5	3931	1	284.22	284.22
合计: 284.22				表面积(m ²)	3.02

A	首次转批	2019-01-05
Rev.	Description	Date

PROJECT: PROPOSED SITE C1 DEVELOPMENT AT AREA 08, KOTLTON TSEUNG KWAN O, NEW TERRITORIES

CLIENT: 美特经贸有限公司
MIDI Aluminium Manufacturing Ltd.
Unit 5-8 Sunny Industrial Centre, 1/F,
610 Chee Kwo Ling Road, Kowloon
Tel: 23489211-4 Fax: (852) 27727866



提昇工程公司
TSEUNG KWAN O LIMITED

[R1-2]

Designed by
Drawn by
Reviewed by
Approved by
Scale
DWG NO: E1 - [R1-2] REV A

RHS250*150*12.5*3931

3462

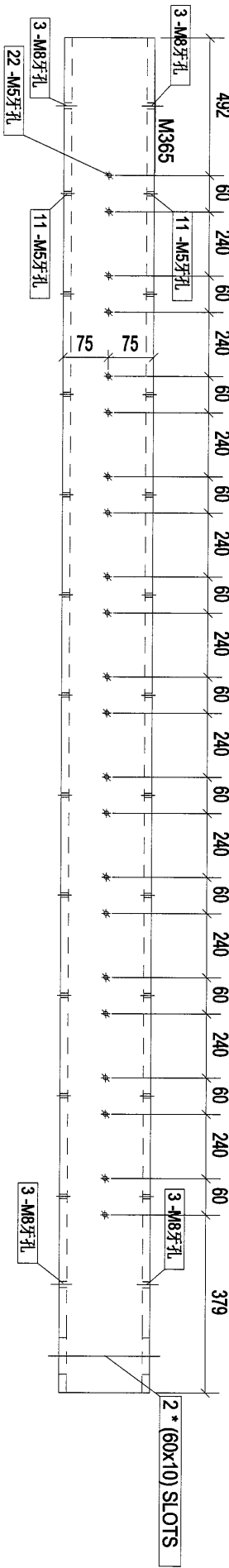
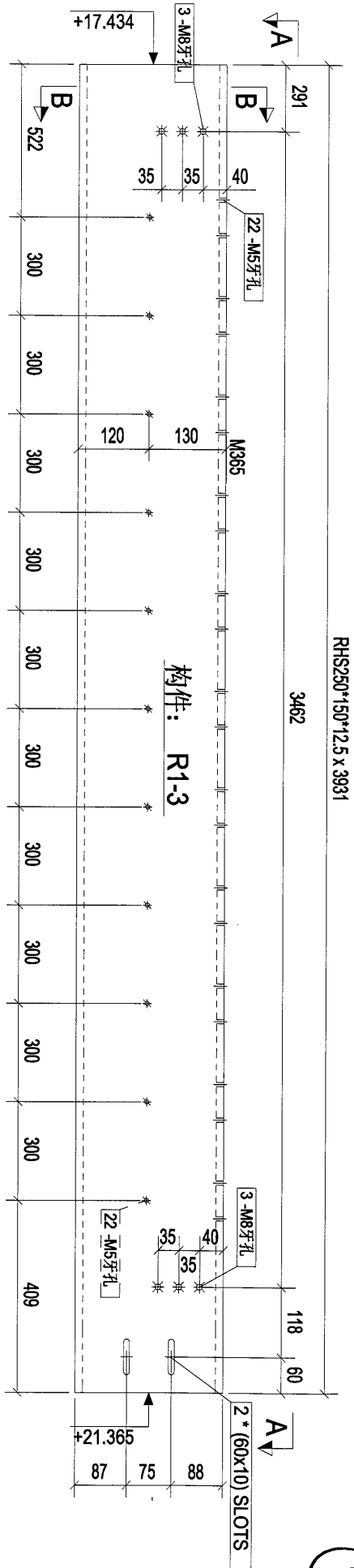

93

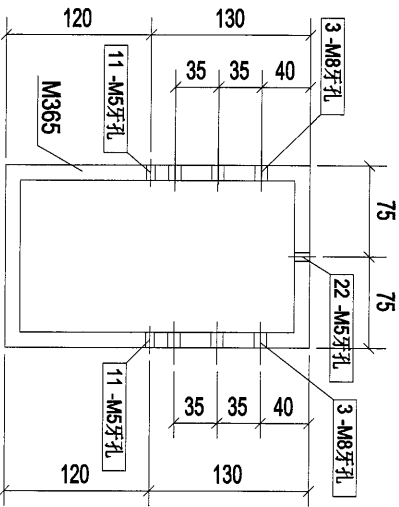
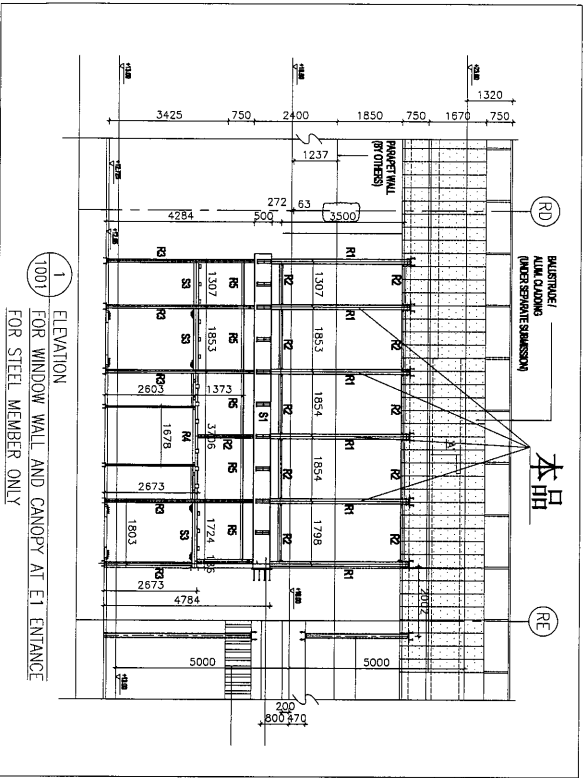

A - A

B - B

构件编号:	R1-3	构件数量:	4	构件重量:	294.22
部件编号	规格(mm)	长度(mm)	数量	单重(kg)	共重(kg)
M365	RHS250*150*12.5	3931	1	294.22	294.22
合计:			294.22	3.02	

PROJECT:	PROPOSED SITE C1 DEVELOPMENT AT AREA 88, TKOIL TOWER, TSEUNG KWAN O, NEW TERRITORIES	DATE:	2019-01-05
CLIENT:	美特鋁質有限公司 MIDI Aluminium Products Co., Ltd. Units 6-8 Sunny Industrial Centre, 61D Chee Kwo Ling Road, Kowloon Tel: 23489211-4 Fax: (852) 27272666	DESIGNED BY:	
		DRAWN BY:	
		REVIEWED BY:	
		APPROVED BY:	
		SCALE:	
DWG NO:	E1		



[R1-3]

1 ELEVATION
FOR WINDOW WALL AND CANOPY AT E1 ENTRANCE
FOR STEEL MEMBER ONLY

94

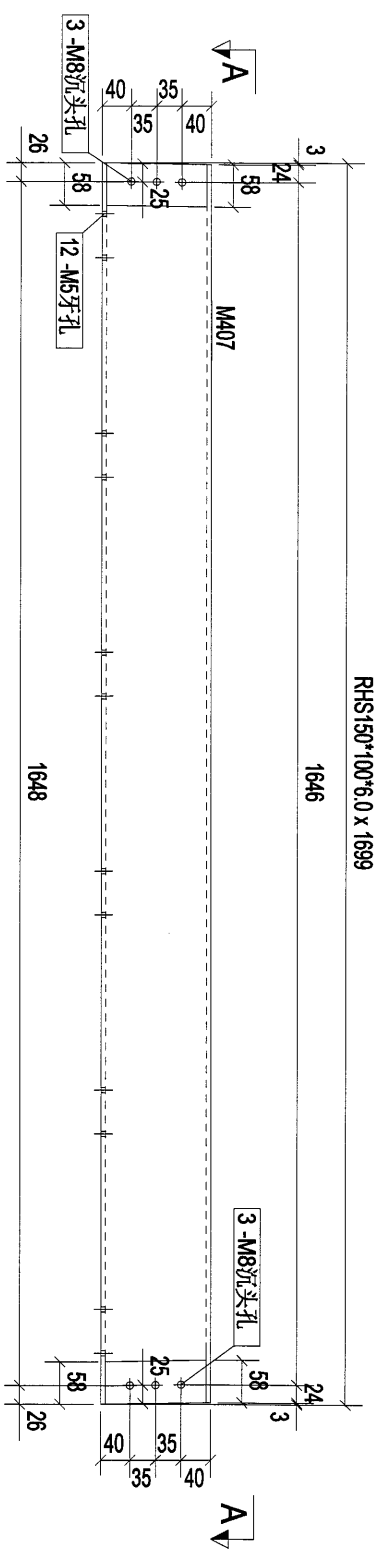

构件: R2-1

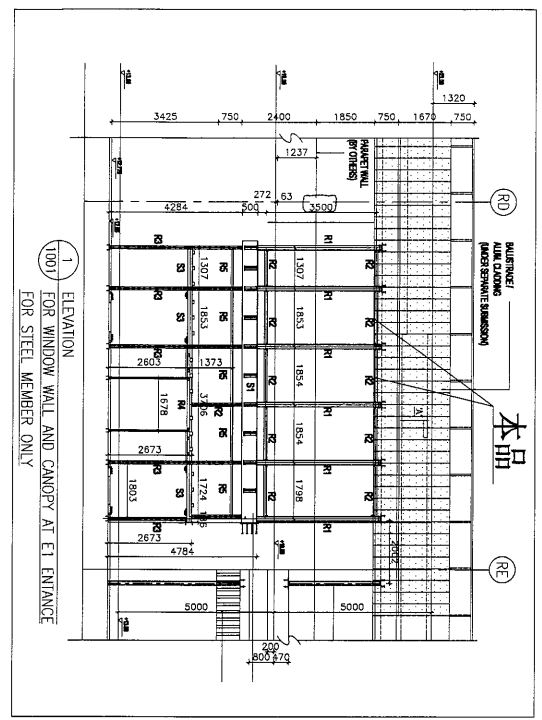
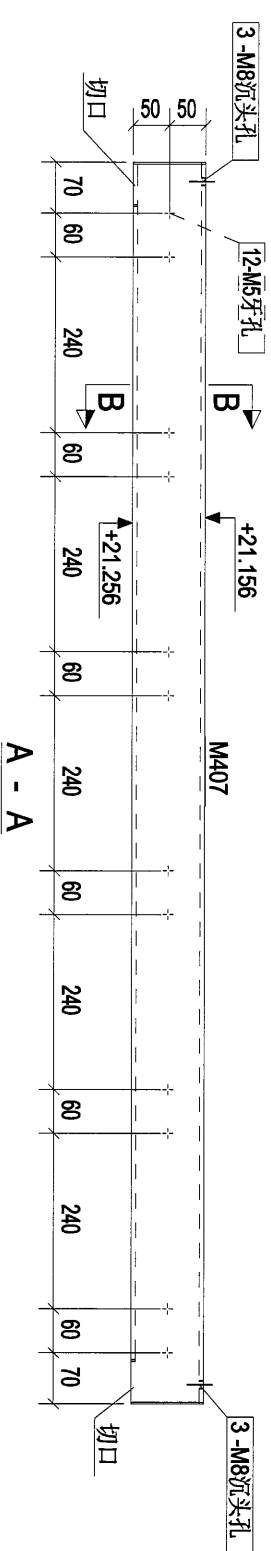

1 ELEVATION FOR WINDOW WALL AND CANOPY AT EI ENTRANCE FOR STEEL MEMBER ONLY

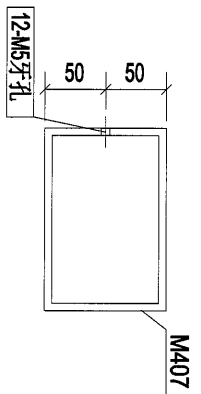

B - B

构件编号:	R2-1	构件数量:	2	构件重量:	37.62
部件编号	规格(mm)	长度(mm)	数量	单重(kg)	共重(kg)
MA07	RHS150*100*6.0	1699	1	37.62	37.62
合计:				37.62	0.82

Rev.	Description	Date
A	第2次报数	2019-01-05

PROJECT: PROPOSED SITE C1 DEVELOPMENT AT AREA 88, TROIL TIDUP, TISENGKAWAN O, NEW TERRITORIES

CLIENT: 美特鋁質有限公司
MIDI Aluminium Products Ltd.
Units B-8, Sanyo Industrial Centre, 1/F
610 Chee Koo Ling Road, Kowloon
Tel: 23489211-4 Fax: (852) 27727666

MEI TAI ALUMINIUM PRODUCTS LTD.
100% 美特鋁質有限公司

[R2-1]

Designed by	
Drawn by	
Reviewed by	
Approved by	
Scale	
DWG NO.:	E1 - [R2-1]
REV.	A

95

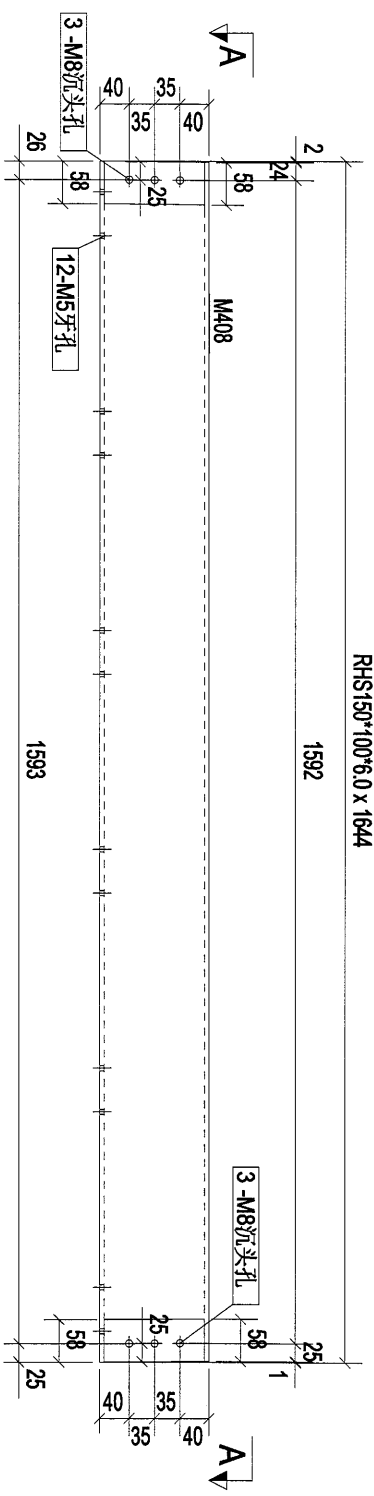

构件: R2-2

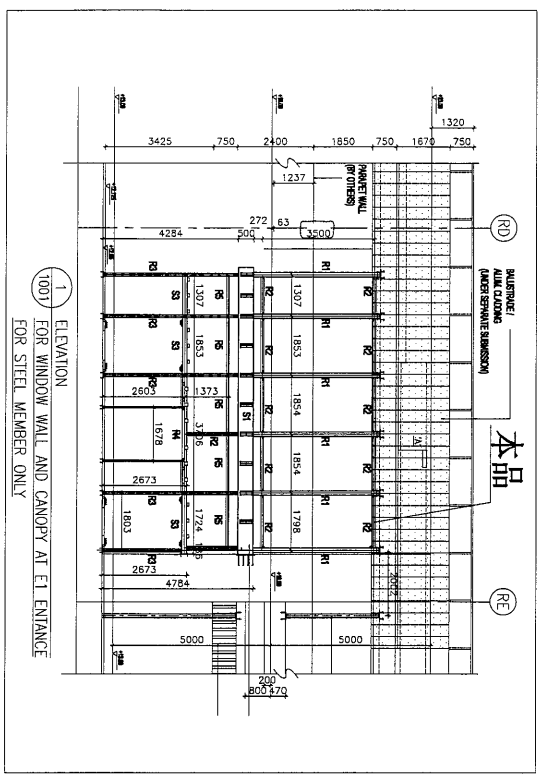
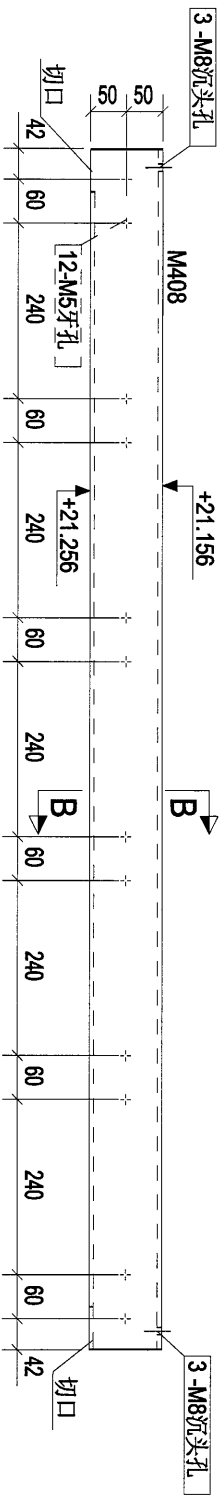

1 ELEVATION FOR WINDOW WALL AND CANOPY AT ENTRANCE FOR STEEL MEMBER ONLY

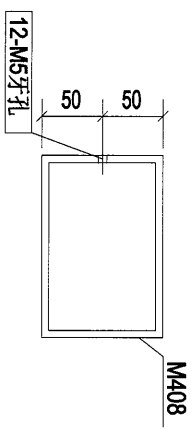

B - B

构件编号:	R2-2	构件数量:	1	构件重量:	36.40
部件编号	规格(mm)	长度(mm)	数量	单重(kg)	共重(kg)
M408	RHS150*100*6.0	1644	1	36.40	36.40
合计:				36.40	0.80

PROJECT:	PROPOSED SITE C1 DEVELOPMENT AT RINGA RD, KOTLORU, TSEMING KIVANNO, NEW TERRITORIES
CLIENT:	美特經貿有限公司 MIDI Advertising Associates Ltd. Units 5-8, Sunny Industrial Centre, 1/F 610 Che Kwo Ling Road, Kowloon Tel: 23489211-4 Fax: (852) 27272668
DESIGNED BY:	捷昌工程公司 JIE CHANG ENGINEERING CO., LTD.
DRAWN BY:	
REVIEWED BY:	
APPROVED BY:	
SCALE:	
DWG NO.:	E1 - R2-2
REV.:	A

RHS150*100*6.0 x 1699

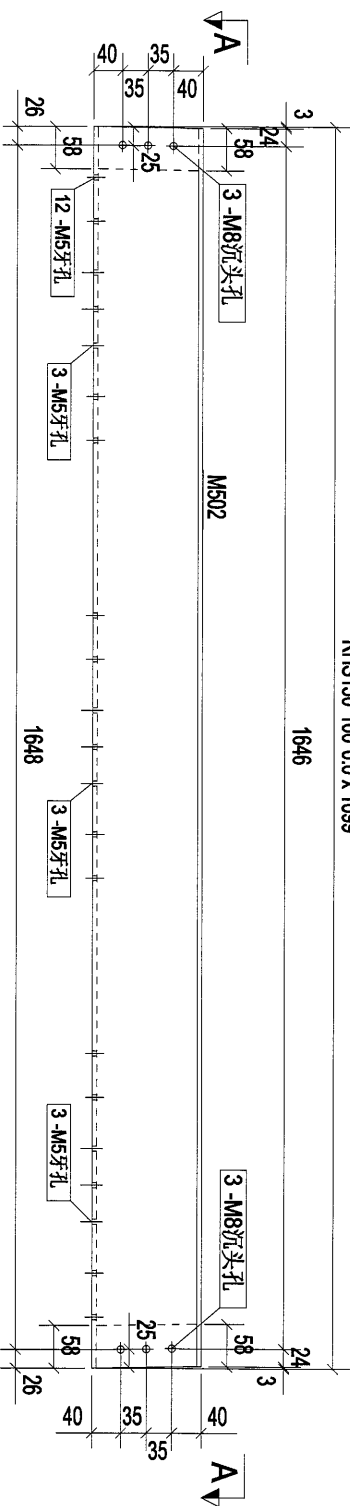

构件: R2-4

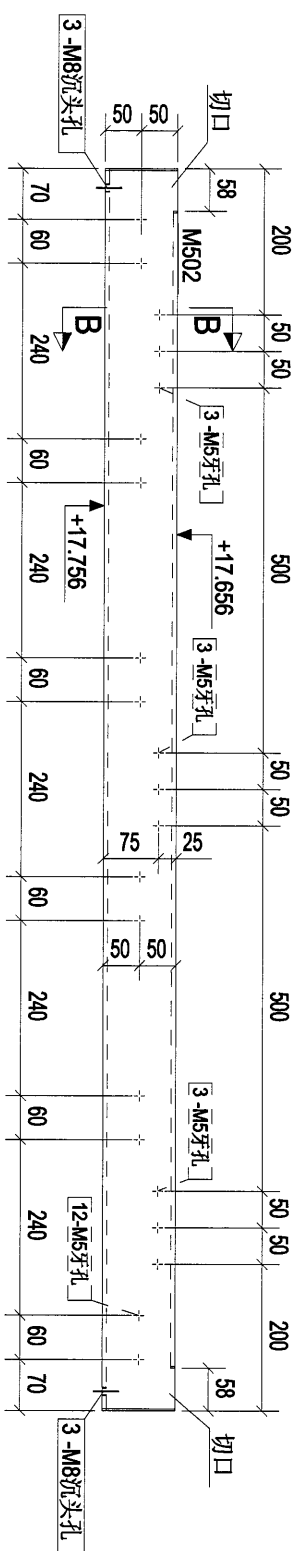

A - A

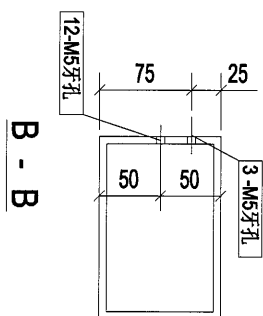

B - B

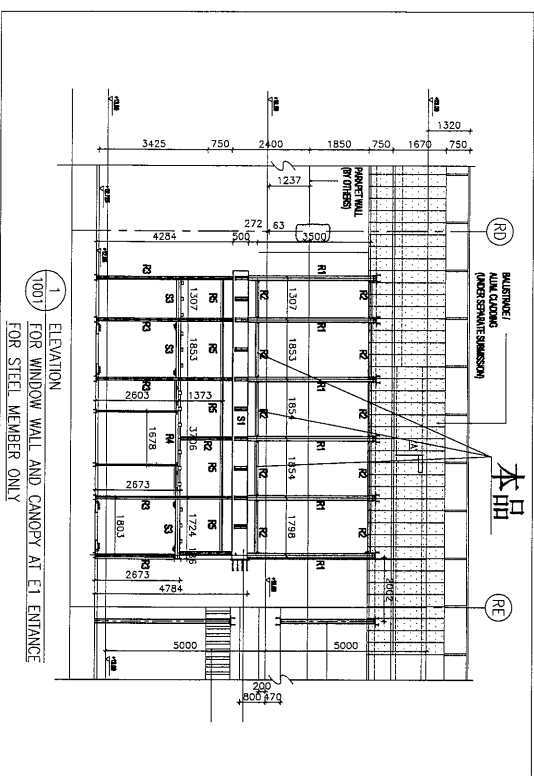

Rev	A	修改描述	2019-01-05
Rev		Description	Date
PROJECT: PROPOSED SITE C1 DEVELOPMENT AT AREA 88, KOTI TORI, TSEUNG KWAN O, NEW TERRITORIES			
CLIENT: 美特經貿有限公司 MIDI Aluminium Fabrication Ltd. Units 5-8, Sunny Industrial Centre, 1/F, 810 Chee Koo Ling Road, Kowloon Tel: 23489211-4 Fax: (852) 27776565			
 捷昇有限公司 MIDI Aluminium Fabrication Ltd.			
[R2-4]			
Designed by			
Drawn by			
Reviewed by			
Approved by			
Scale			
DWG NO: E1		- [R2-4]	
		REV	A

97

99

RHS150*100*6.0 x 1153

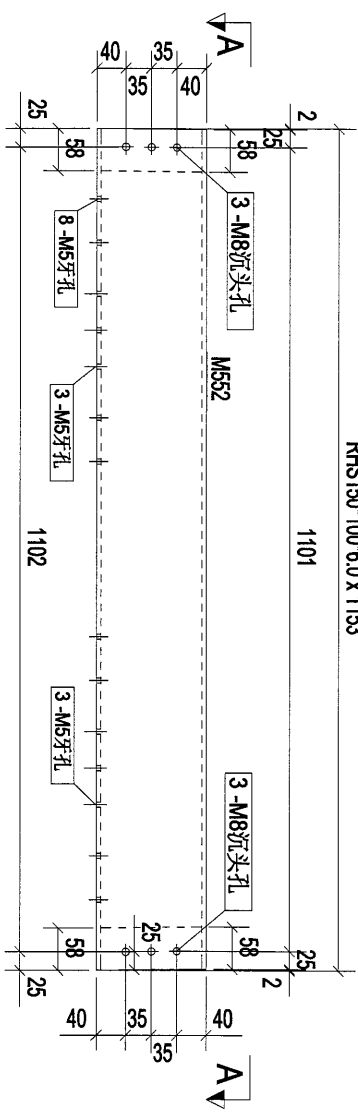

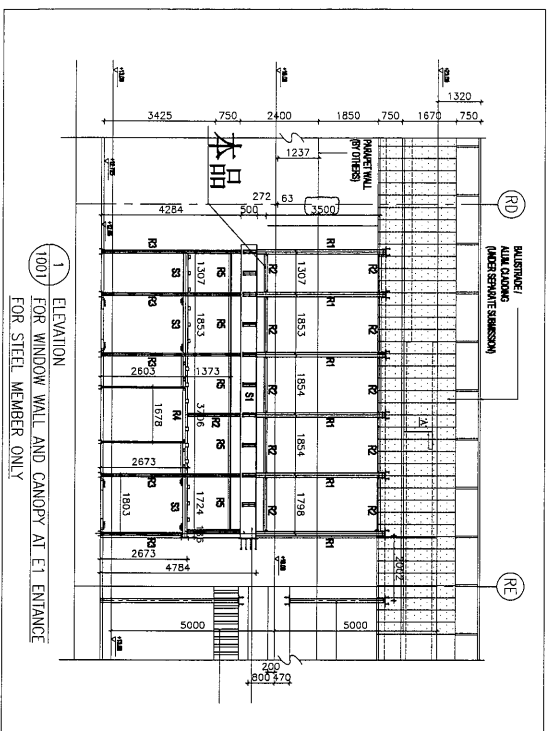
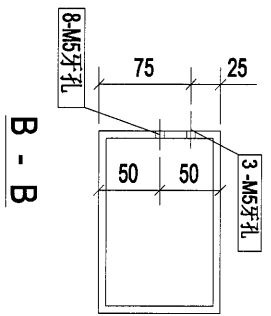
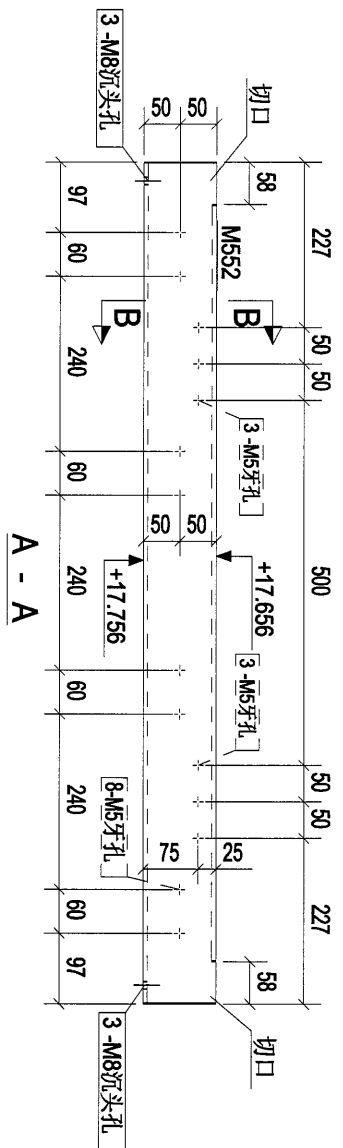

构件: R2-6



1 ELEVATION FOR WINDOW WALL AND CANOPY AT ENTRANCE FOR STEEL MEMBER ONLY

构件编号:	R2-6	构件数量:	1	构件重量:	25.53
部件编号	规格(mm)	长度(mm)	数量	单重(kg)	共重(kg)
M552	RHS150*100*6.0	1153	1	25.53	25.53
合计:				25.53	0.56

Rev.	A	第2次修改	2019-01-05
Description	PROPOSED SITE C1 DEVELOPMENT AT AREA 88, TROILTON, TSEUNG KWAN O, NEW TERRITORIES		
CLIENT:	 美特经贸有限公司 MIDDI Aluminium Fabrication Ltd. Units E-8, Sunco Industrial Centre, 1/F 610 Chee Koo Ling Road, Kowloon Tel: 2348921-4 Fax: (852) 2777866		
PROJECT:	 捷昌石隆公司 捷昌石隆有限公司 231 號 104TH Limited		
Designed by	[R2-.61]		
Drawn by			
Reviewed by			
Approved by			
Scale			
DWG NO.	E1	-	[R2-.61]

100

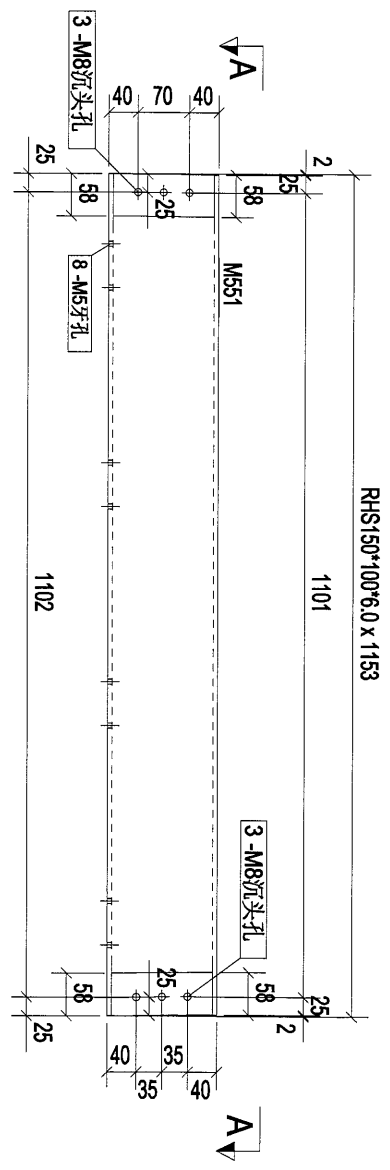

构件: R2-7

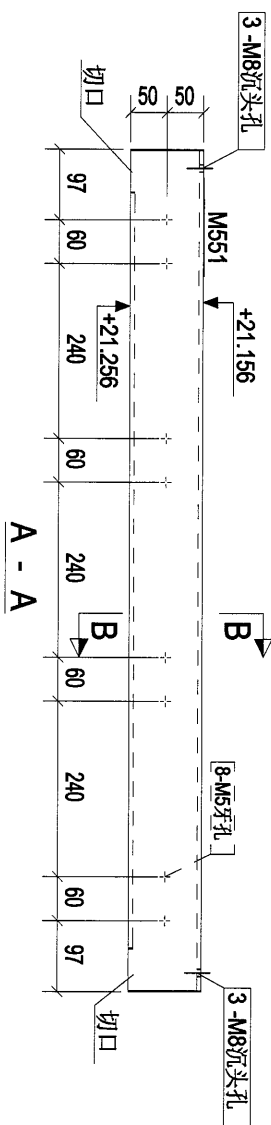

A - A

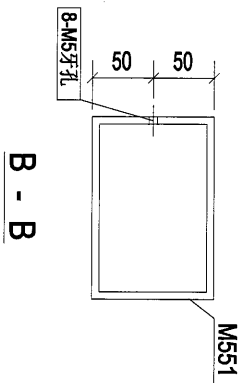

B - B

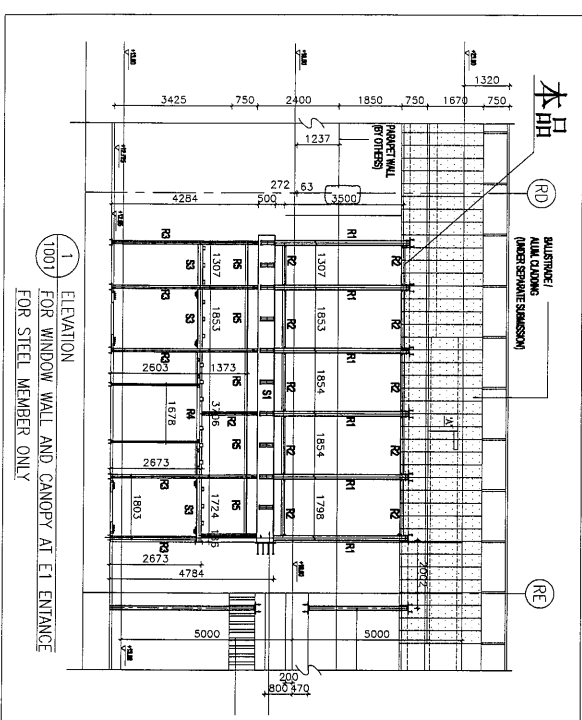

1 ELEVATION FOR WINDOW WALL AND CANOPY AT ET ENTRANCE FOR STEEL MEMBER ONLY

构件编号	规格(mm)	长度(mm)	数量	单重(kg)	共重(kg)	表面积(m ²)
M551	RHS150*100*6.0	1153	1	25.53	25.53	0.56
合计:				25.53		

PROJECT:	PROPOSED SITE C1 DEVELOPMENT AT AREA 88, KOTU TO RP TSEUNG KWAN O, NEW TERRITORIES
CLIENT:	美特鋁質有限公司 MIDI Aluminium 510 Chee Kwo Ling Road, Kowloon Tel: 23468211-4 Fax: (852) 27277856
Rev.	A 第2次报批
Description	
Date	2019-01-05
Designed by	
Drawn by	
Reviewed by	
Approved by	
Scale	
DWG NO:	E1 - [R2-7]
REV	A

101

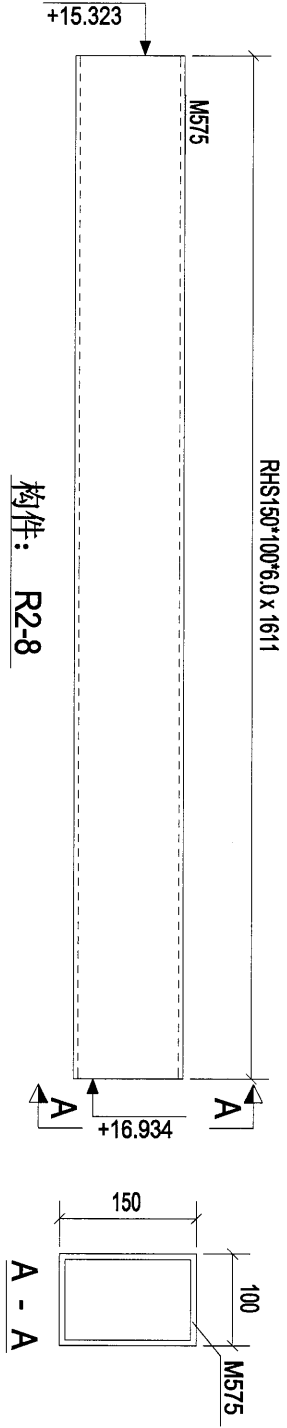

构件: R2-8

RHS150*100*6.0 x 1611

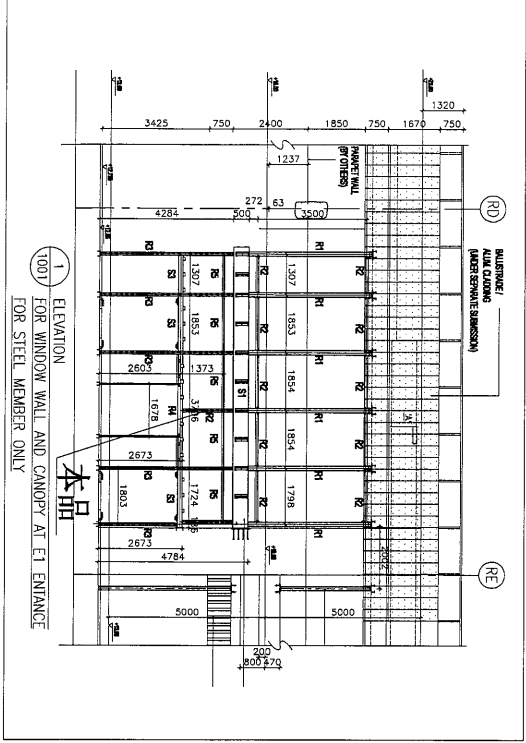

构件编号:	R2-8	构件数量:	1	构件重量:	35.65
部件编号	规格(mm)	长度(mm)	数量	单重(kg)	表面积(m ²)
M575	RHS150*100*6.0	1611	1	35.65	0.78
合计:			35.65		

A	第2次修改	2019-01-05
Rev.	Description	Date

PROJECT: PROPOSED SITE C1
DEVELOPMENT AT AREA 88,
TKOIL TONG TSEUNG KWAN O,
NEW TERRITORIES

CLIENT: 華特經貿有限公司
MIDI Investment / Infrastructure Ltd.
Units E-8, Sunway Indefinite Centre,
610 Chee Kwo Ling Road, Kowloon
Tel: 23489211-4 Fax: (852) 27272656

耀石建築有限公司
YIP SHING ARCHITECTS LIMITED

[R2-8]

Designed by	
Drawn by	
Reviewed by	
Approved by	
Scale	
DWG NO: E1	- R2-8
REV	A

102

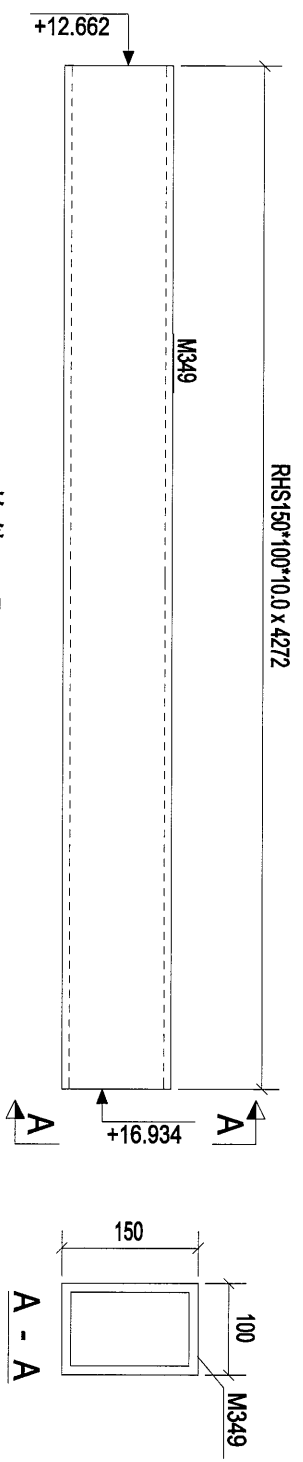

构件: R3-1

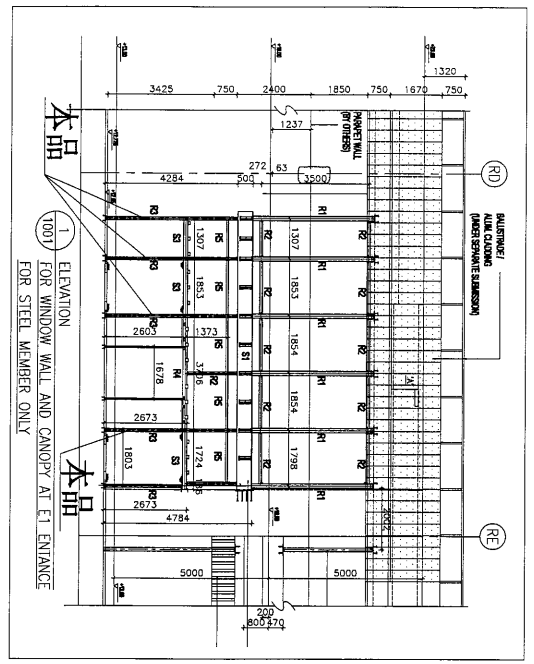

构件编号	规格(mm)	长度(mm)	数量	单重(kg)	共重(kg)	表面积(m ²)
M349	RHS150*100*10.0	4272	1	150.56	150.56	2.02
合计:				150.56		

Rev.	A	第2次提报	2018-01-05
PROJECT:	PROPOSED SITE C1 DEVELOPMENT AT AREA 88, KOTU TO RP TSEUNG KWAN O, NEW TERRITORIES		
CLIENT:	 美特经有限公司 MIDI Investment Development Limited Units 6-8, Sam Ho Industrial Centre, 1/F 510 Che Kwo Ling Road, Kowloon Tel: 23469211-4 Fax: 8527778656		
Designed by	[R3-1]		
Drawn by			
Reviewed by			
Approved by			
Scale			
DWG NO.:	E1	-	[R3-1]
REV	A		

105

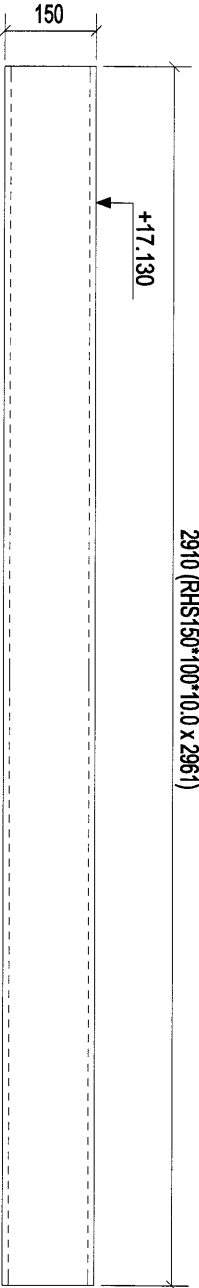

构件: R3-4

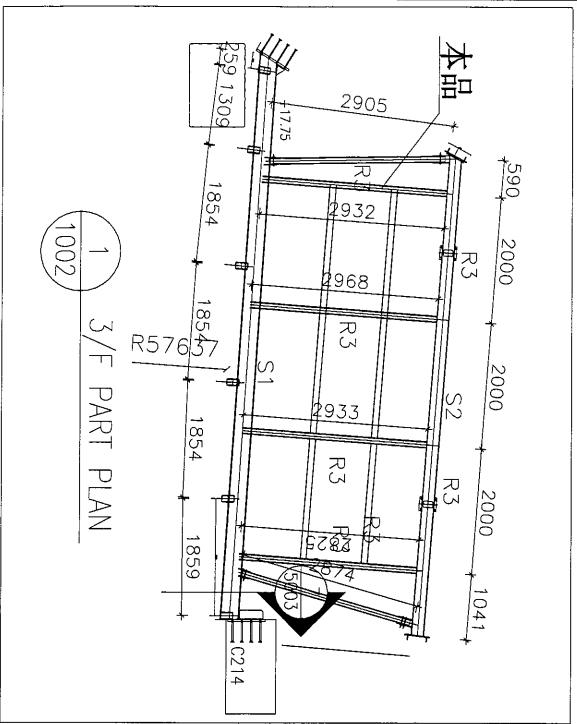

Rev.	Description	Date
A	第2次校核	2019-01-05

PROJECT: PROPOSED SITE C1
DEVELOPMENT AT AREA 88,
TKOIL TOWER, TSEUNG KWAN O,
NEW TERRITORIES

CLIENT: 美特堅實有限公司
MIDI Aluminium Fabrication Ltd.
Units F-6 Sunny Industrial Centre, 1/F
810 Chee Kwo Ling Road, Kowloon
Tel: 23489211-4 Fax: (852) 27727666

設計及工程有限公司
SHI YEE LEONG Limited

[R3-4]

构件编号:	R3-4	构件数量:	1	构件重量:	102.58
部件编号:	M344	长度(mm):	2910	共重(Kg):	102.58
规格(mm):	RHS150*100*10.0	数量:	1	表面积(m ²):	1.38
		单重(Kg):	102.58	合计:	102.58

Designed by	
Drawn by	
Reviewed by	
Approved by	
Scale	
DWG NO.:	E1 - R3-4
REV	A

107

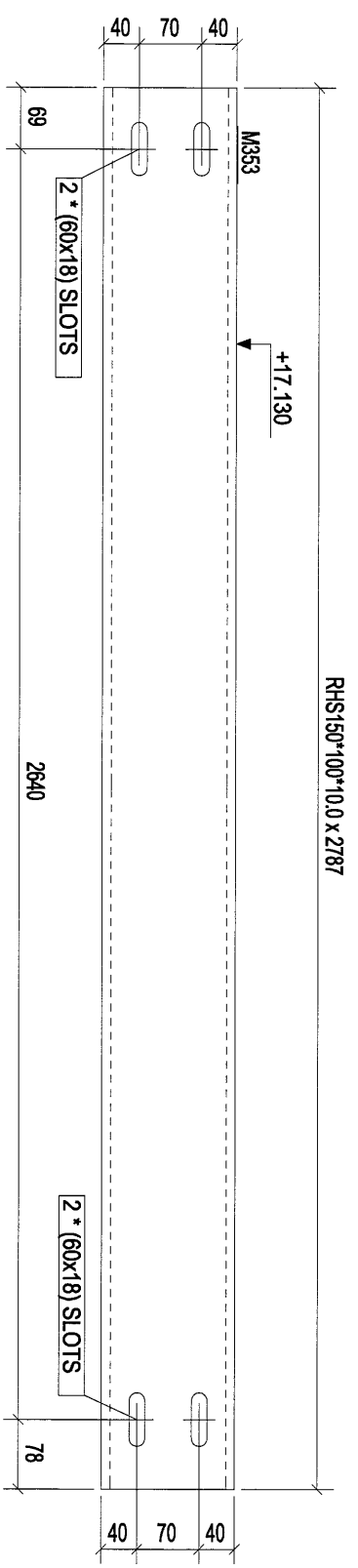

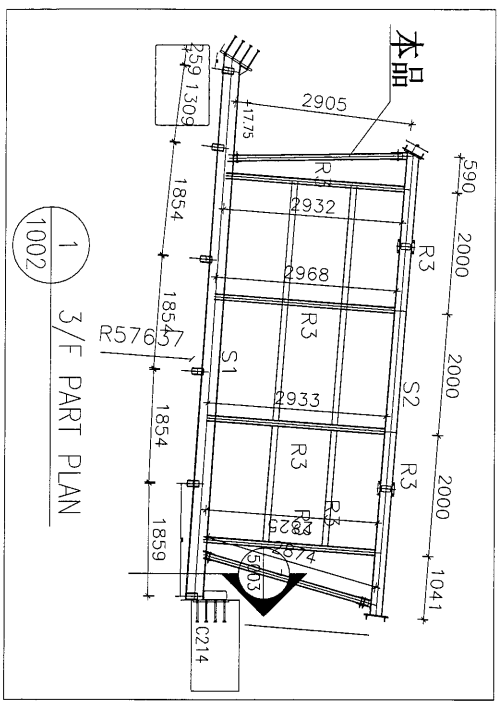

RHS150*100*10.0 x 2787

构件: R3-6



构件编号:	R3-6	构件数量:	1	构件重量:	98.22
部件编号	规格(mm)	长度(mm)	数量	单重(Kg)	共重(Kg)
M353	RHS150*100*10.0	2787	1	98.22	98.22
合计:				98.22	1.32

Rev	0	首次提批	2019-01-05
Description	PROJECT: PROPOSED SITE C1 DEVELOPMENT AT AREA 08, TKOIL TON/TSEUNG KWAN O, NEW TERRITORIES		
Client	 基特經貿有限公司 MIDY ASSOCIATED INVESTMENT LTD. Units 5-8 Sunny Industrial Centre, 1/F 610 Chee Koo Ling Road, Kowloon Tel: 23489211-4 Fax: (852) 27727666		
Design	 捷石有限公司 捷石有限公司 104AT Limited		
Scale	[R3-6]		
Design	Designed by		
Drawn	Drawn by		
Reviewed	Reviewed by		
Approved	Approved by		
Scale	Scale		
DMGNO:	E1	- R3-6	REV 0

108

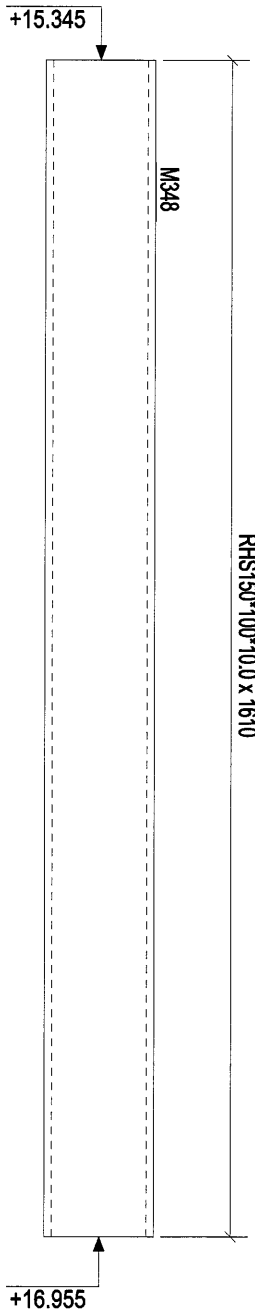

构件: R3-7

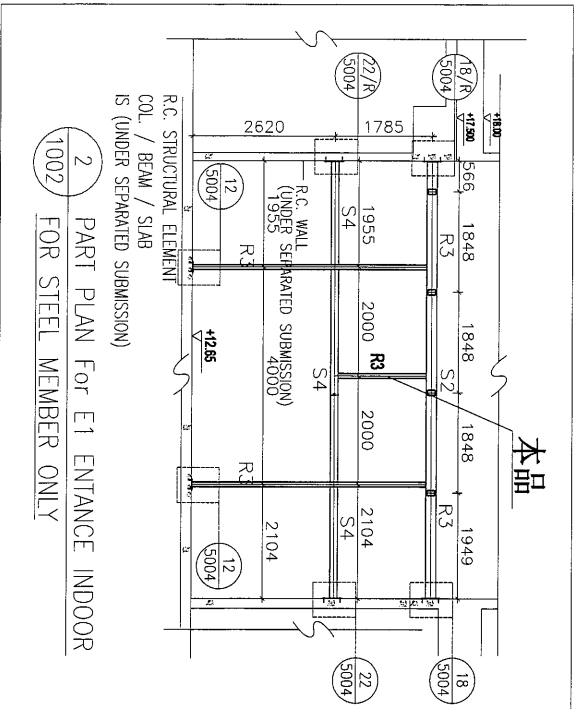

Rev.	0	第一次提报	2019-01-05
Description	DATE		

PROJECT: PROPOSED SITE C1
DEVELOPMENT AT AREA 88,
KOTL'ONG, TSEUNG KWAN O,
NEW TERRITORIES

CLIENT: 華特經貿有限公司
MIDI Architecture & Interactor Inc.
Units E-8, Sino-Indoia Center, 1/F
610 Chee Koo Ling Road, Kowloon
Tel: 23489211-4 Fax: (852) 27727858

[R3-7]

构件编号:	R3-7	构件数量:	1	构件重量:	56.74	表面积(m ²):	0.76
部件编号	规格(mm)	长度(mm)	数量	单重(kg)	共重(kg)	表面积(m ²)	
M348	RHS150*100*10.0	1610	1	56.74	56.74	0.76	
合计:				56.74			

Designed by	
Drawn by	
Reviewed by	
Approved by	
Scale	
DWG NO: E1	- R3-7
REV	0

109

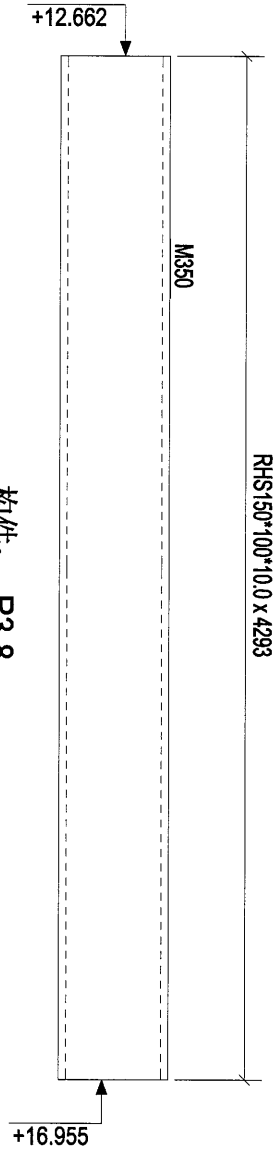

构件: R3-8

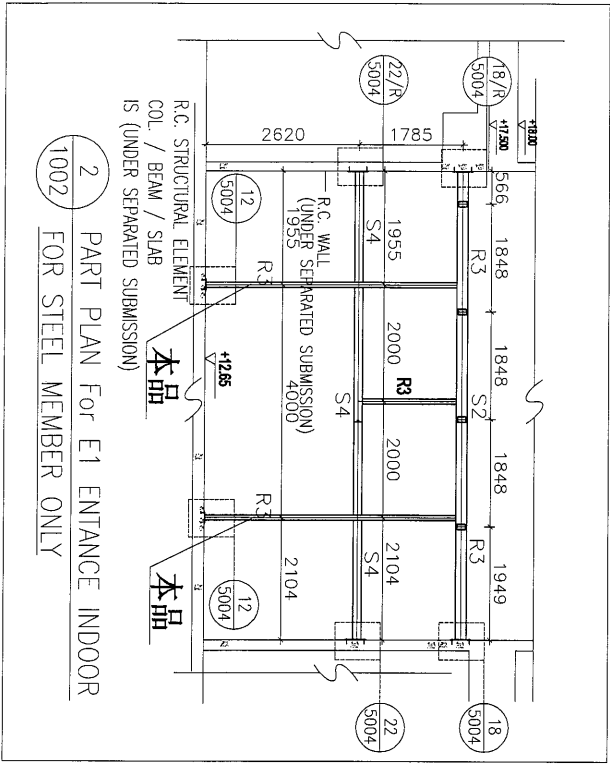

Rev.	Description	Date
A	第2次提报	2019-01-05

PROJECT: PROPOSED SITE C1 DEVELOPMENT AT AREA 08, TQ01, TQ1P, TSEUNG KWAN O, NEW TERRITORIES

CLIENT: 基特經貿有限公司
 MDTJ Development Management Limited
 Unit 6-B, Sunny Industrial Centre, 17
 610 Chee Kwo Ling Road, Kowloon
 Tel: 23498211-4 Fax: (852) 27272666



设计/审核/出图/日期
 [R3-8]

构件编号	规格(mm)	长度(mm)	数量	单重(kg)	共重(kg)	表面积(m ²)
M350	RHS150*100*10.0	4293	1	151.30	151.30	2.03
合计:			2	151.30	151.30	2.03

Designated by	
Drawn by	
Reviewed by	
Approved by	
Scale	
DMG NO: E1	- [R3-8]
REV	A

110

RHS150*100*10.0 x 2511

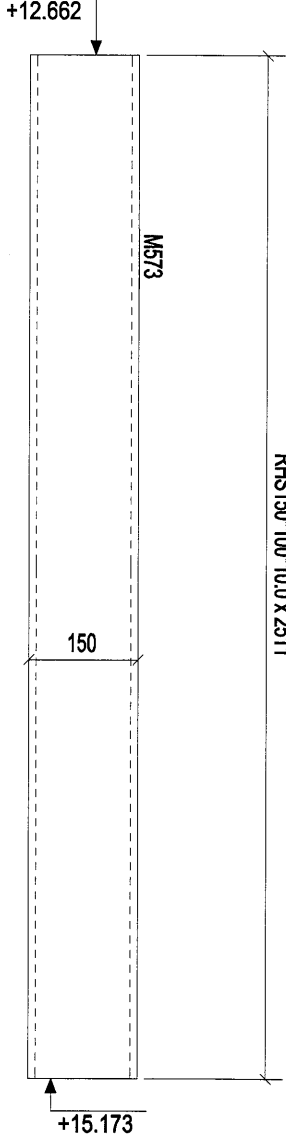

构件: R3-9

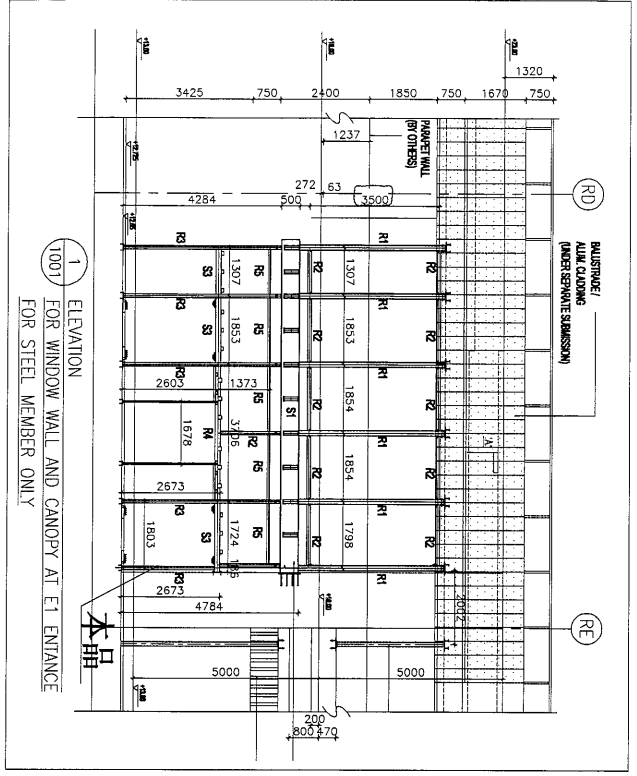

Rev.	A	第2次提批	2019-01-05
PROJECT:	PROPOSED SITE C1 DEVELOPMENT AT AREA 88, KOIL TO HO TSEUNG KWAN O, NEW TERRITORIES		
CLIENT:	 美特鋁質有限公司 MTR Aluminium Fabrication Ltd. Units 6-8, Sunny Industrial Centre, 1/F 610 Chee Kwo Ling Road, Kowloon Tel: 23489211 - 4 Fax: (852) 27272656		
Designed by	[R3-9]		
Drawn by			
Reviewed by			
Approved by			
Scale	1:19		
DWG NO.	E1	- R3-9	REV. A

构件编号:	R3-9	构件数量:	1	构件重量:	88.50
规格(mm)	RHS150*100*10.0	长度(mm)	2511	数量	1
表面积(m ²)		单重(kg)	88.50	共重(kg)	88.50
合计:					88.50

111

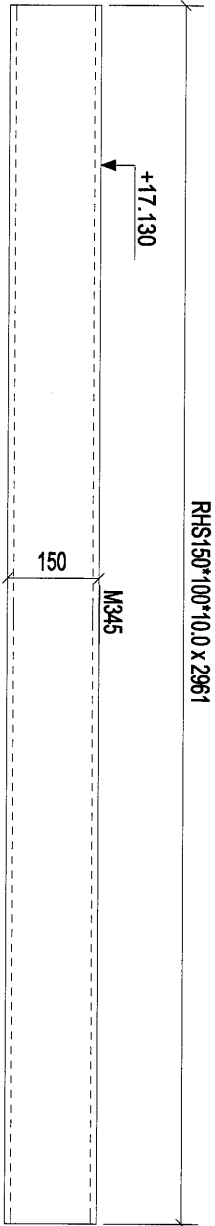

RHS150*100*10.0 x 2961

构件: R3-10

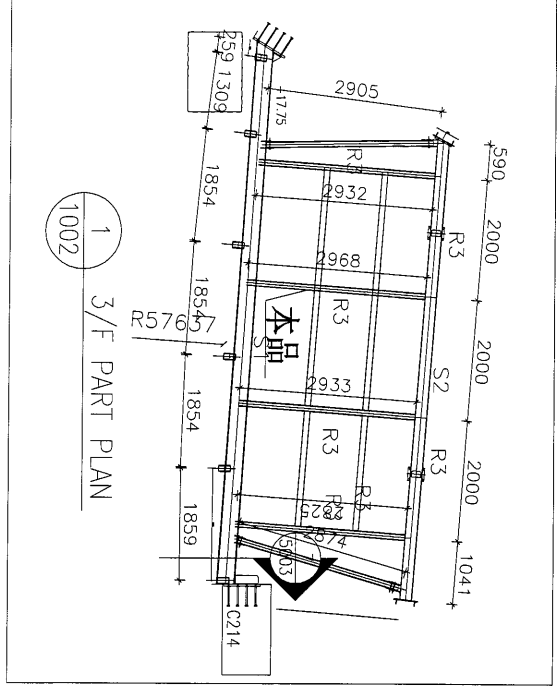

构件编号: R3-10		构件数量: 1		构件重量: 104.36	
部件编号	规格(mm)	长度(mm)	数量	单重(kg)	共重(kg)
M345	RHS150*100*10.0	2961	1	104.36	104.36
合计:				104.36	1.40

Rev.	Description	Date
0	第一次报批	2019-01-05

PROJECT:
 PROPOSED SITE C1
 DEVELOPMENT AT AREA 88,
 TKOIL 70/RP TSEUNG KWAN O,
 NEW TERRITORIES

CLIENT:
美特經貿有限公司
 MIDT Customer Services Ltd.
 Unit 5-B, Sandwell Industrial Centre, 1/F
 810 Chee Kwoi Ling Road, Kowloon
 Tel: 22489211-4 Fax: (852) 27272858

捷成石港有限公司
 Silver Point Limited

[R3-10]

Designed by _____
 Drawn by _____
 Reviewed by _____
 Approved by _____
 Scale _____
 DWG NO: E1 - [R3-10]

REV: 0

112

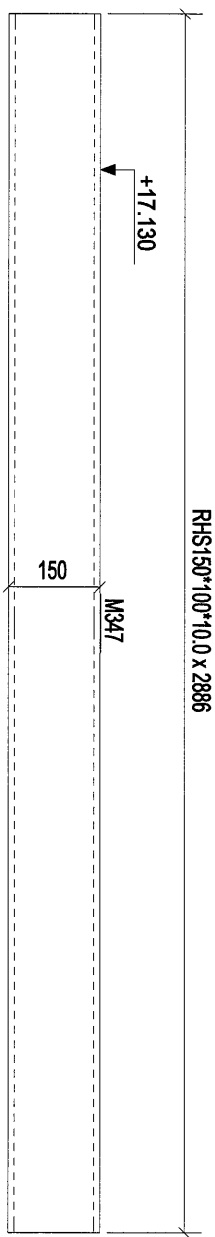

RHS150*100*10.0 x 2886

构件: R3-11

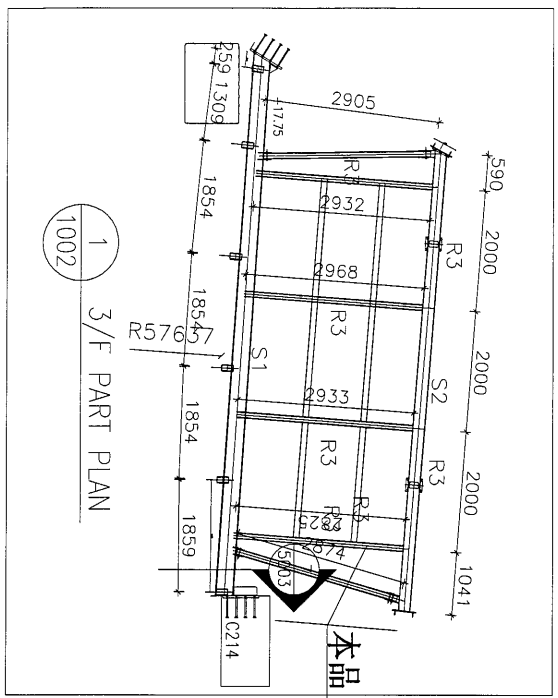

0	第一次提报	2019-01-05
Rev.	Description	Date

PROJECT: PROPOSED SITE C1
DEVELOPMENT AT ANEKA, 88,
TOLITOLIT, SELONG KAWAN O,
NEW TERRITORIES

CLIENT: 美特 經 實 有 限 公 司
MIDI Aluminium Association Ltd.
Units 6-8, Sunray Industrial Centre, 1/F,
610 Chee Kwo Ling Road, Kowloon
Tel: 23489211-4 Fax: (852) 27275656

美特經實有限公司
MIDALUMINIUM ASSOCIATION LIMITED

[R3-11]

构件编号:	R3-11	构件数量:	1	构件重量:	101.73	表面积(m ²):	1.37
部件编号	规格(mm)	长度(mm)	数量	单重(kg)	共重(kg)	表面积(m ²)	
M347	RHS150*100*10.0	2886	1	101.73	101.73	1.37	
合计:				101.73			

Designed by	
Drawn by	
Reviewed by	
Approved by	
Scale	
DWG NO.:	E1 - [R3-11]
REV.	0

113

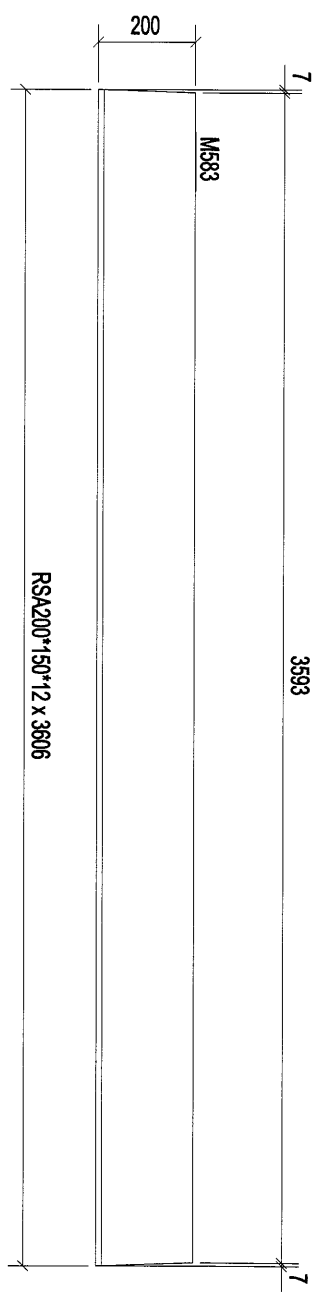

构件: R4-1

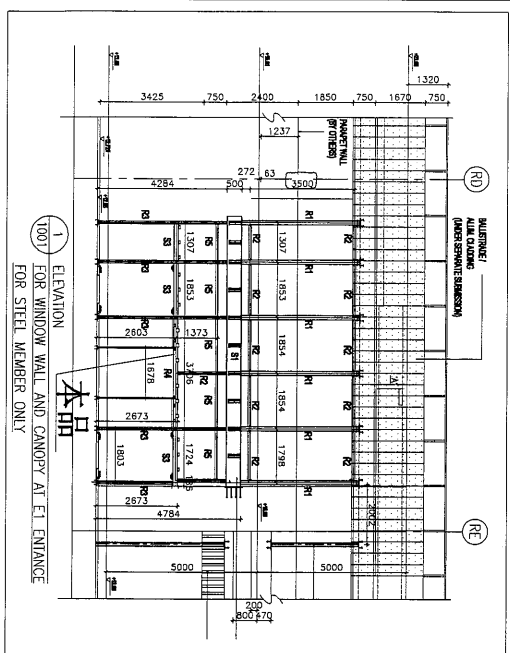

构件编号	规格(mm)	长度(mm)	数量	单重(kg)	共重(kg)	表面积(m ²)
M583	RSA200*150*12	3606	1	115.90	115.90	2.49
合计:				115.90		

Rev	Revision	Date
A	首次發批	2019-01-05

PROJECT: PROPOSED SITE C1 DEVELOPMENT AT AREA 88, KOTLONR TSEUNG KWAN O, NEW TERRITORIES

CLIENT: 華特經貿有限公司
MIDI Management Associates Ltd.
610 Chee Koo Ling Road, Kowloon
Tel: 23489211-4 Fax: (852) 27727868

總工程師有限公司
312號 104TH Limited

[R4-1]

Designed by	
Drawn by	
Reviewed by	
Approved by	
Scale	
DWG NO: E1	- R4-1
REV	A

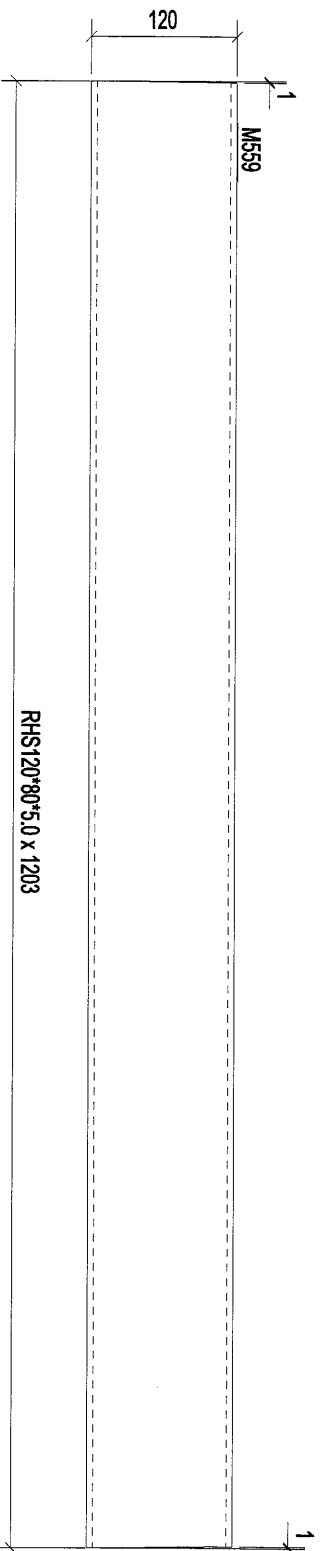

RHS120*80*5.0 x 1203

构件: R5-1

114

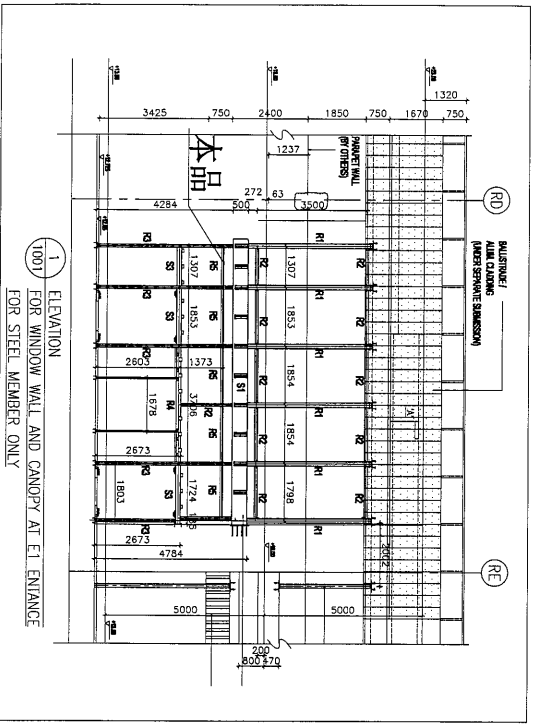

1 ELEVATION
FOR WINDOW WALL AND CANOPY AT E1 ENTRANCE
FOR STEEL MEMBER ONLY

Rev.	A	第2次雜批	2019-01-05
Description			

PROJECT: PROPOSED SITE C1
DEVELOPMENT AT AREA 88,
KOTI, TORI, TSEUNG KWAN O,
NEW TERRITORIES

CLIENT: 華特經貿有限公司
MTR Development (Asia) Limited
Units F-8 Sunny Industrial Centre /
610 Chee Koo Ling Road, Kowloon
Tel: 23489211-4 Fax: (852) 27278566

華特經貿有限公司
MTR Development (Asia) Limited

[R5-1]

构件编号:	R5-1	构件数量:	1	构件重量:	17.66	
部件编号	规格(mm)	长度(mm)	数量	单重(kg)	共重(kg)	表面积(m ²)
M559	RHS120*80*5.0	1203	1	17.66	17.66	0.47
合计:					17.66	

Designed by	
Drawn by	
Reviewed by	
Approved by	
Scale	
DWG NO: E1	- R5-1
REV	A

115

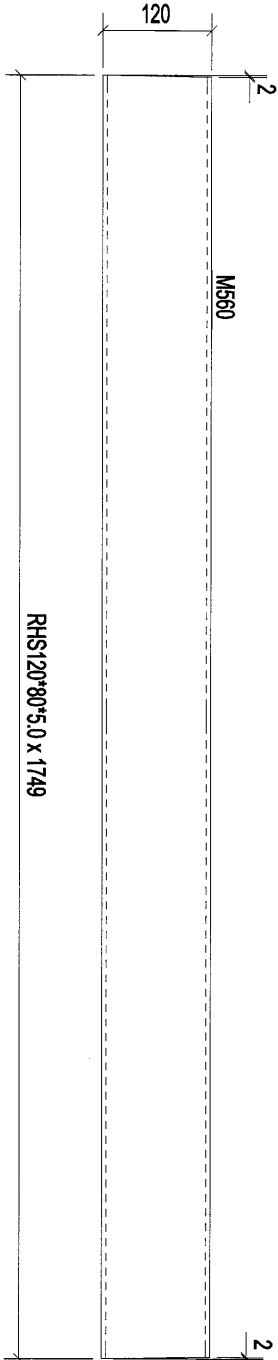

RHS120*80*5.0 x 1749

构件: R5-2

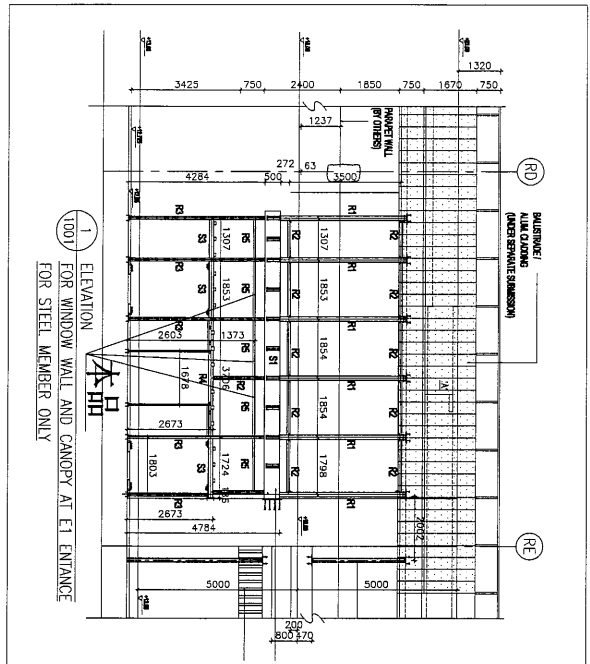

构件编号:	RS-2			构件数量:	3			构件重量:	25.68		
部件编号	规格(mm)	长度(mm)	数量	重量(kg)	表面积(m ²)						
M560	RHS120*80*5.0	1749	1	25.68	0.68						
合计:		25.68									

A	第2次修改	2019-01-05
Rev.	Description	Date

PROJECT: PROPOSED SITE C1 DEVELOPMENT AT AREA 08, TROIL TONG TSEUNG KWAN O, NEW TERRORIES

CLIENT: 華特鋁質有限公司
MIDI Aluminium Products Int'l.
Units E-8 Sunny Industrial Centre, 1/F,
610 Chee Kwo Ling Road, Kowloon
Tel: 23489211-4 Fax: (852) 27272666



捷昇工程公司
JIT Engineering Limited

Designed by	
Drawn by	
Reviewed by	
Approved by	
Scale	
DWG NO: E1	- RS-2
REV	A

[RS-2]

116

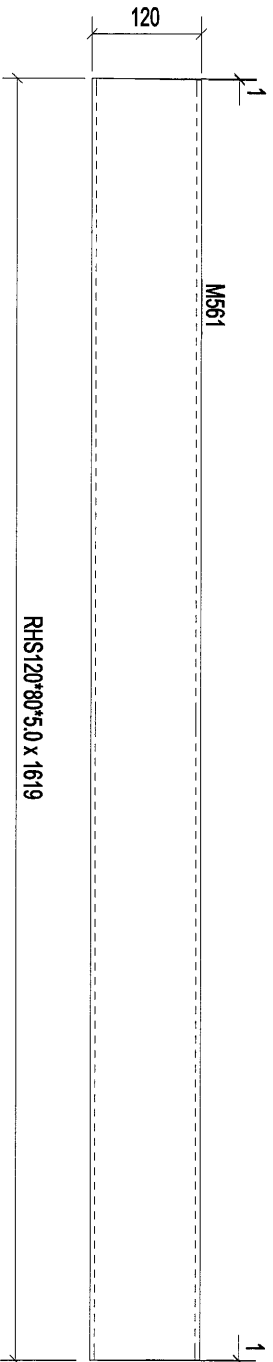

RHS120*80*5.0 x 1619

构件: R5-3

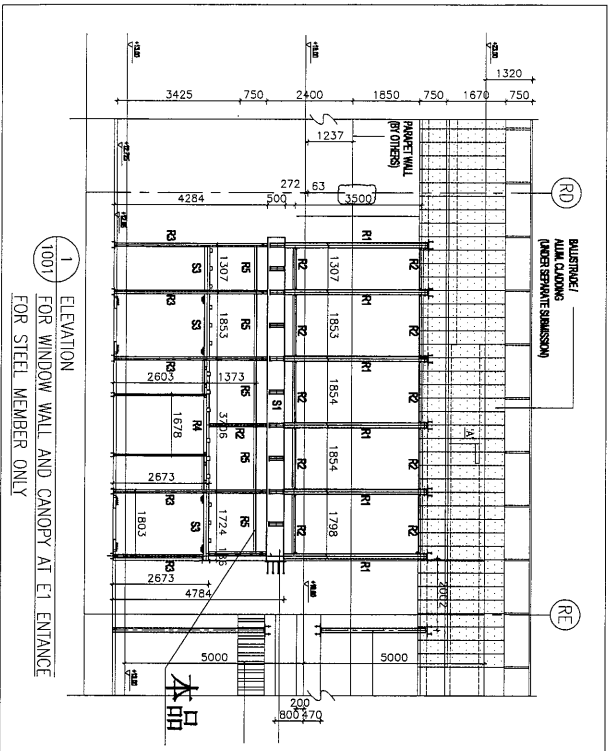

构件编号:	R5-3	构件数量:	1	构件重量:	23.77
部件编号	规格(mm)	长度(mm)	数量	单重(kg)	共重(kg)
MS61	RHS120*80*5.0	1619	1	23.77	23.77
合计:					23.77
表面积(m ²)	0.63				

Rev.	第2次修改	Date	2019-01-05
------	-------	------	------------

PROJECT: PROPOSED SITE C1 DEVELOPMENT AT AREA 88, KOTI L'OR, TSEUNG KWAN O, NEW TERRITORIES

CLIENT: 美特經貿有限公司
MIDI
ALUMINUM FABRICATOR LTD.
Units 5-8, Sunny Industrial Centre, 1/F,
610 Chee Kwo Ling Road, Kowloon
Tel: 23448921-4 Fax: (852) 27272666

[R5-3]

Designed by	
Drawn by	
Reviewed by	
Approved by	
Scale	
DWG NO.:	E1 - R5-3
REV.	A

117

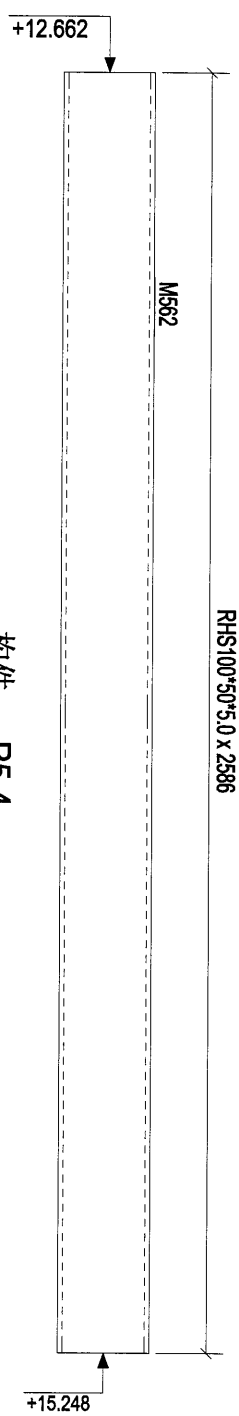

构件: R5-4

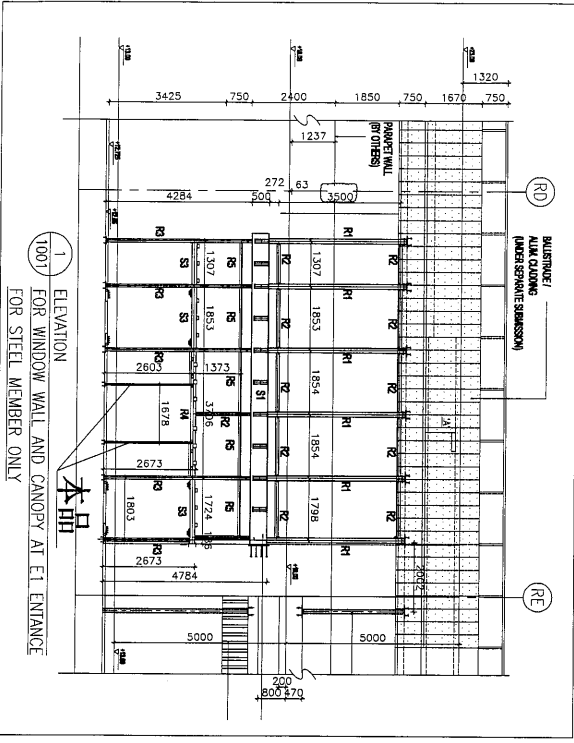

构件编号	规格(mm)	长度(mm)	数量	单重(kg)	共重(kg)	表面积(m ²)
M562	RHS100*50*5.0	2586	1	27.81	27.81	0.74
合计:			2	27.81	27.81	27.81

Rev.	Description	Date
A	第一次报批	2019-01-05

PROJECT: PROPOSED SITE C1 DEVELOPMENT AT AREA 66, KOTU 70/P, TSEUNG KWAN O, NEW TERRITORIES

CLIENT: 美特铝业有限公司
MIDI ALUMINIUM FABRICATOR LTD.
Unit 5-6, Sunny Industrial Centre, 1/F
510 Cheong Cheong Street, Tseung Kwan O
Tel: 2489211-4 Fax: (852) 27270566

设计: 捷成工程有限公司
SINCE 1984 Limited

[R5-4]

Design by	Down by	Reviewed by	Approved by	Scale	DWG NO.	REV.
					E1	A

118

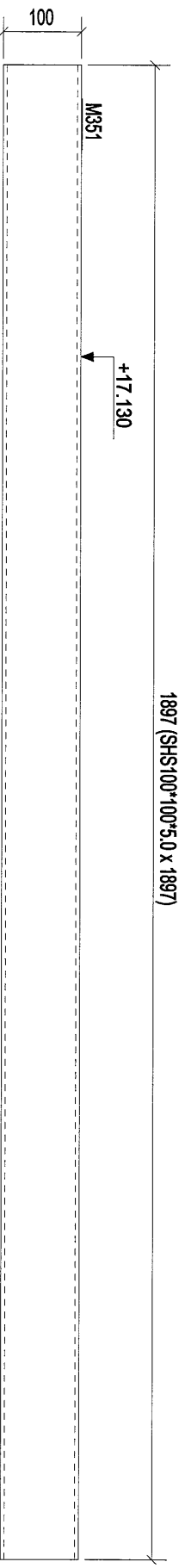

1897 (SHS100*100*5.0 x 1897)

构件: R6-1

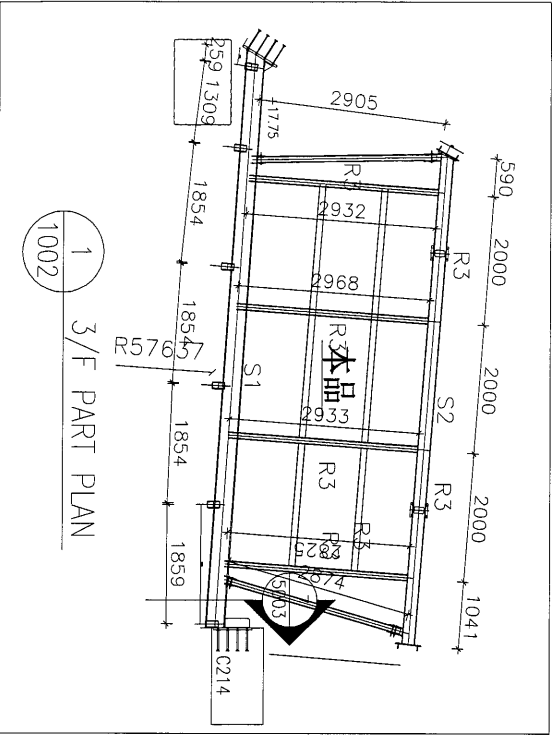

Rev.	0	第1次提單	2019-01-05
Description	PROJECT: PROPOSED SITE C1 DEVELOPMENT AT AREA 88, KOTLAND, TSEUNG KUAN O, NEW TERRITORIES		

CLIENT: 美特經貿有限公司
MIDI AUSTRALIA INVESTMENT LTD.
610 Chee Koo Ling Road, Kowloon
Tel: 23489211-4 Fax: (852) 27272656

美特經貿有限公司
MIDI AUSTRALIA INVESTMENT LTD.

[R6-1]

构件编号:	R6-1	构件数量:	2	构件重量:	27.85
部件编号:	规格(mm)	长度(mm)	数量	单重(kg)	共重(kg)
M351	SHS100*100*5.0	1897	1	27.85	27.85
合计:				27.85	0.73

Designed by	
Drawn by	
Reviewed by	
Approved by	
Scale	
DMGNO: E1	- [R6-1]
REV	0

119

SHS100*100*5.0 x 1900

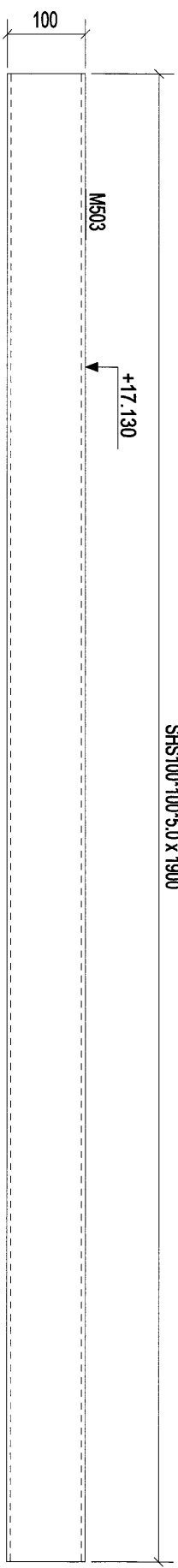

构件: R6-2

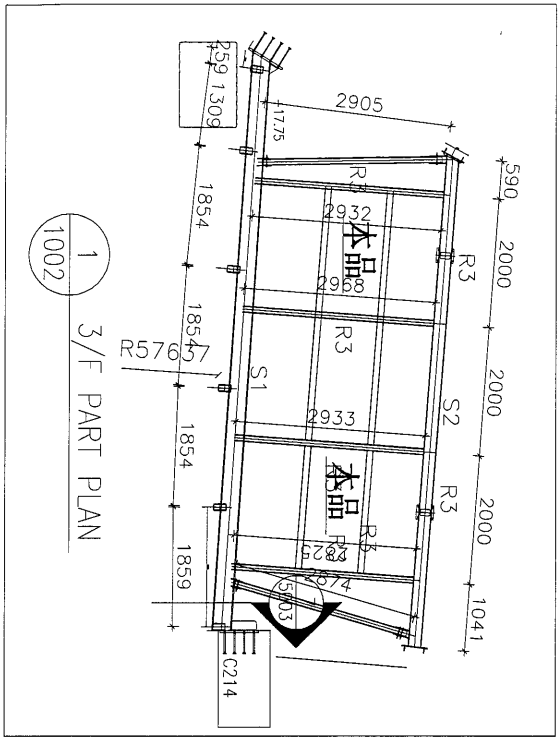

构件编号:	R6-2	构件数量:	4	构件重量:	27.89
规格(mm)	SHS100*100*5.0	长度(mm)	1900	共重(kg)	27.89
数量	1	单重(kg)	27.89	表面积(m ²)	0.74
合计:				27.89	

Rev.	0	首次提报	2019-01-05
Description			

PROJECT: PROPOSED SITE C1
DEVELOPMENT AT NEAR, KOTLONTI, SENSOI KWAN O, NEW TERRITORIES

CLIENT: 美特經貿有限公司
MIDI AUSTRALIA PTY LTD
Units 6-8, Sunray Industrial Centre, 1/F
510 Chiu Kwo Ling Road, Kwailoon
Tel: (852) 27776568 Fax: (852) 27776568

[R6-2]

Designed by	
Drawn by	
Reviewed by	
Approved by	
Scale	
DMGNO: E1	- R6-2
REV	0

121

A

A

SHS200*200*10.0 x 7669

M343

+17.155

构件: S2-1

M343

A - A

11

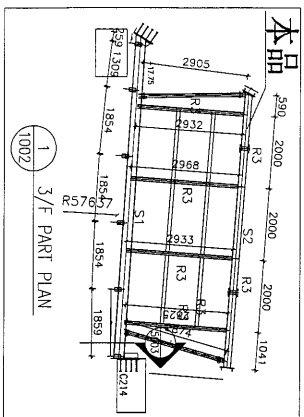

构件编号	规格(mm)	长度(mm)	数量	单重(kg)	构件重量	表面积(m ²)
M343	SHS200*200*10.0	7669	1	450.93	450.93	5.94
合计:					450.93	

CLIENT:	美特经贸有限公司 MIDI International Association Ltd. Units 6-8, Sunny Industrial Centre, 1/F 610 Chu Kuo Ling Road, Kowloon Tel: (852) 489211-4 Fax: (852) 2727665						
PROJECT:	PROPOSED SITE C1 DEVELOPMENT IN AREA 08, TOLTE TOWN, TSEUNG KWAN HO, NEW TERRITORIES						
Rev.	<table border="1"> <tr> <th>A</th> <th>第2次报批</th> <th>2019-01-05</th> </tr> <tr> <td> </td> <td>Description</td> <td>Date</td> </tr> </table>	A	第2次报批	2019-01-05		Description	Date
A	第2次报批	2019-01-05					
	Description	Date					
Designed by							
Drawn by							
Reviewed by							
Approved by							
Scale							
DWG NO.:	E1 - [S2-1]						
REV.	A						

[S2-1]

122

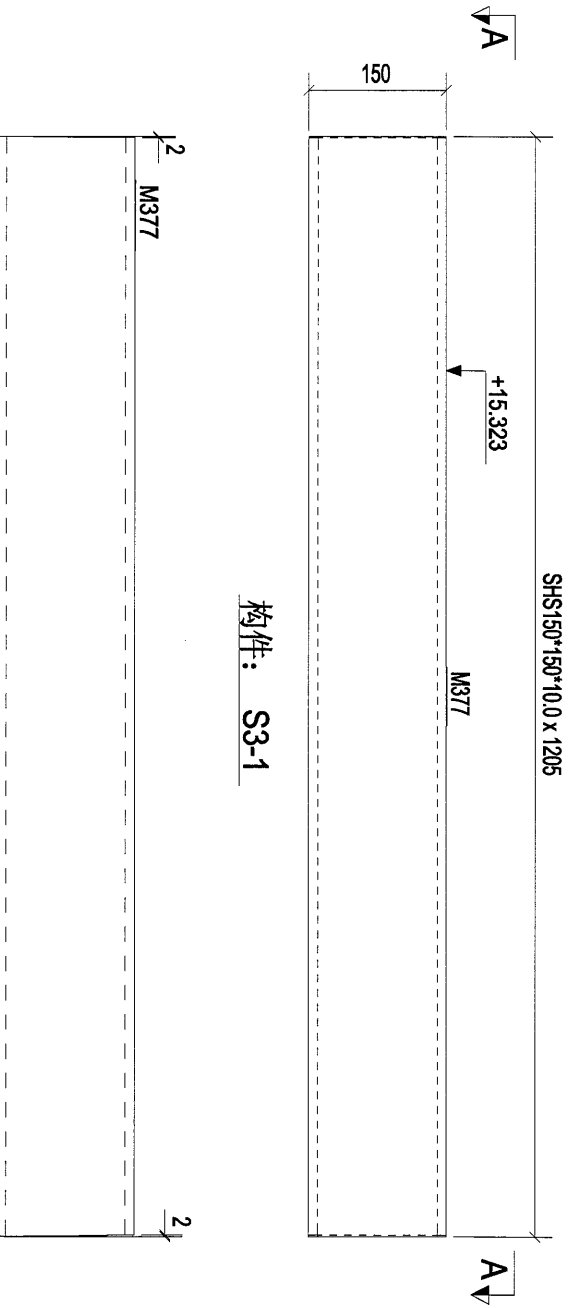

构件: S3-1

A - A

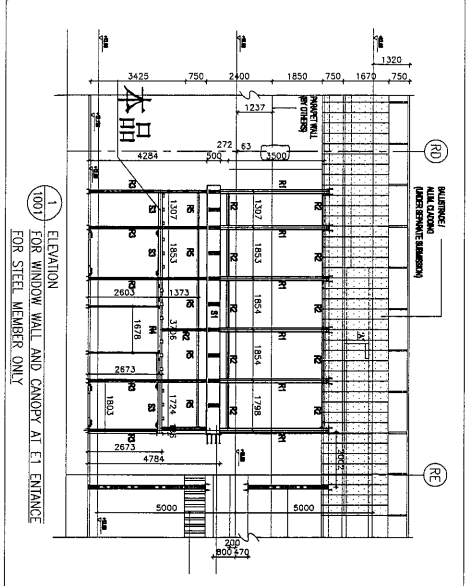

构件编号:	S3-1	构件数量:	1	构件重量:	51.91
部件编号	规格(mm)	长度(mm)	数量	单重(kg)	共重(kg)
M377	SHS150*150*10.0	1205	1	51.91	51.91
合计:				51.91	0.69

Rev.	A	第2次设计	2019-01-05
Description	PROJECT: PROPOSED SITE C1 DEVELOPMENT AT AREA NO. 10/11/12, TSEUNG KWAN O, NEW TERRITORIES		

CLIENT: 基特經貿有限公司
MIDI Investment Associates Ltd.
Unit 5-8, Suning Industrial Centre, 1/F,
610 Chin Kwo Ling Road, Kowloon
Tel: (23)46211-4 Fax: (82)27272666

DESIGNED BY: [Blank]
DRAWN BY: [Blank]
REVIEWED BY: [Blank]
APPROVED BY: [Blank]
Scale: [Blank]

DESIGN NO.:	E1	-	S3-1	REV.:	A
-------------	----	---	------	-------	---

123

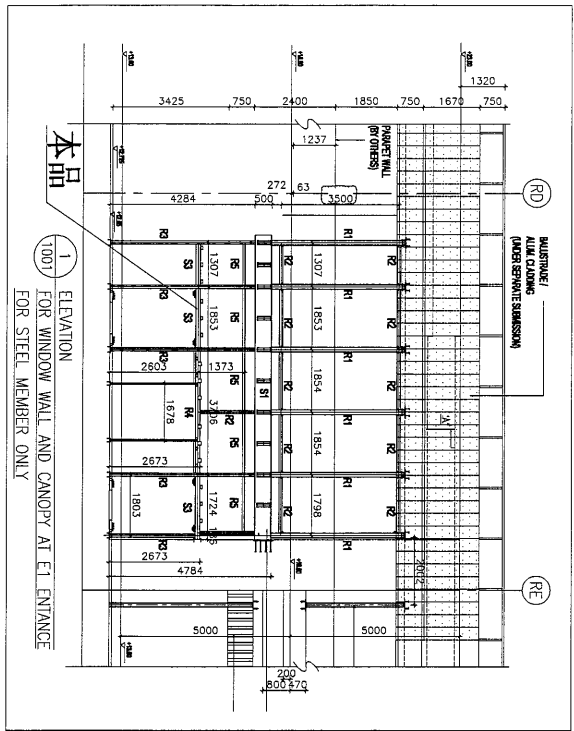
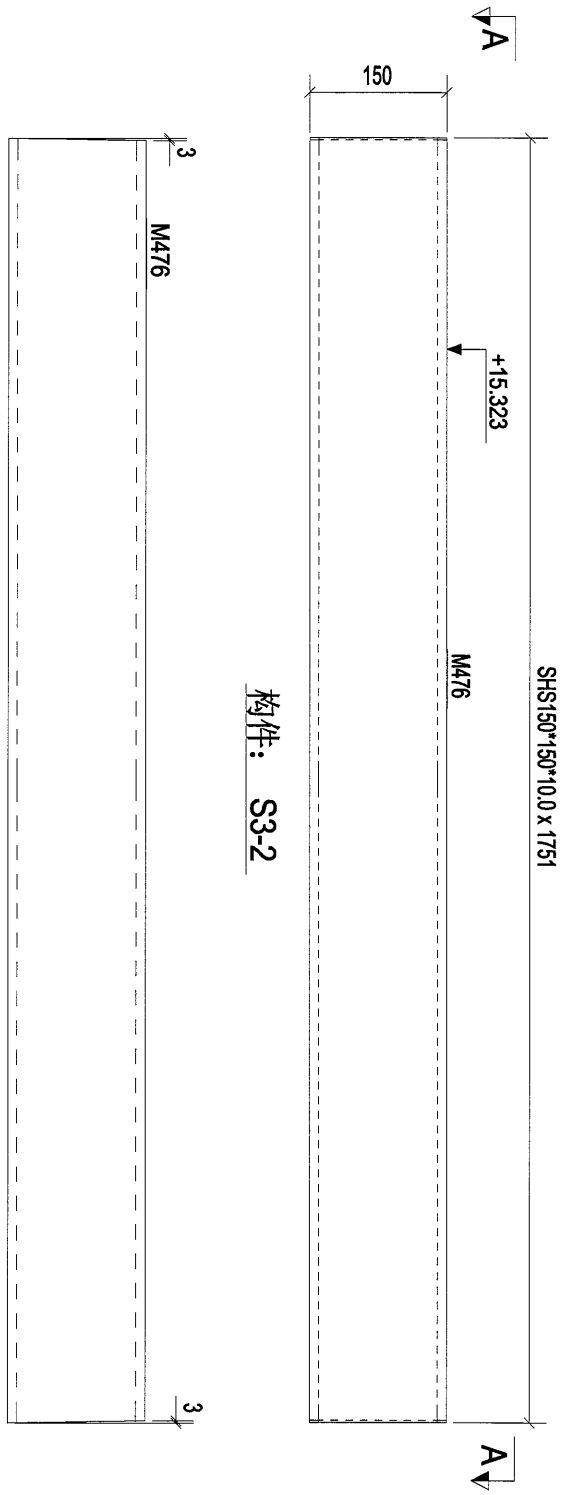

A - A

构件: S3-2

构件编号:	S3-2	构件数量:	1	构件重量:	75.48
规格(mm)	SHS150*150*10.0	长度(mm)	1751	共重(kg)	75.48
数量	1	单重(kg)	75.48	表面积(m ²)	1.01
合计:				75.48	

Rev.	Description	Date
A	第2次设计	2019-01-05

PROJECT: PROPOSED SITE C1 DEVELOPMENT AT AREA 88, TOTTI TORP, TSEUNG KWAN O, NEW TERRITORIES

CLIENT: 基特堅有限公司
MIDI Aluminium Manufacturers Ltd.
Unit 6-8, Sunny Industrial Centre, 1/F,
610 Chin Kwo Ling Road, Kowloon
Tel: (852) 24892111-4 Fax: (852) 27276666

设计人: 基特堅有限公司
MIDI Aluminium Manufacturers Ltd.

[S3-2]

Designed by	
Drawn by	
Reviewed by	
Approved by	
Scale	
DWGNO.: E1	- S3-2
REV.	A

SHS150*150*10.0 x 1859

+15.323

M378

150

构件: S3-3

M378

A - A

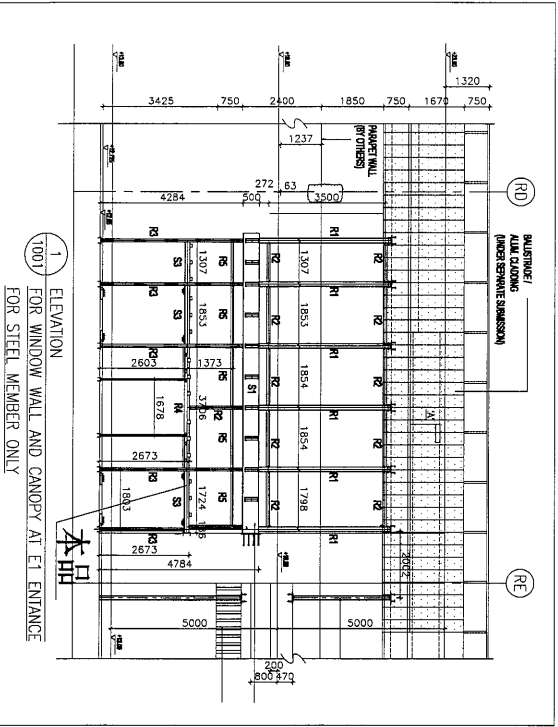

构件编号:	S3-3	构件数量:	1	构件重量:	80.13
部件编号	规格(mm)	长度(mm)	数量	单重(kg)	共重(kg)
M378	SHS150*150*10.0	1859	1	80.13	80.13
合计:					80.13
					表面积(m ²)
					1.07

Rev.	A	第2次设计	2019-01-05
Description			

PROJECT: PROPOSED SITE C1
DEVELOPMENT AT AREA A08,
TWO/TWO/F, TSEUNG KWAN O,
NEW TERRITORIES

CLIENT: 華特銘實有限公司
MIDI Architectural Associates Ltd.
Units 6-8, Sunny Industrial Centre, 1/F,
610 Chee Kwo Ling Road, Kowloon
Tel: (852) 249211-4 Fax: (852) 27275666



[S3-3]

Designed by
Drawn by
Reviewed by
Approved by

Scale
DWG NO.: E1 - [S3-3]

124

125

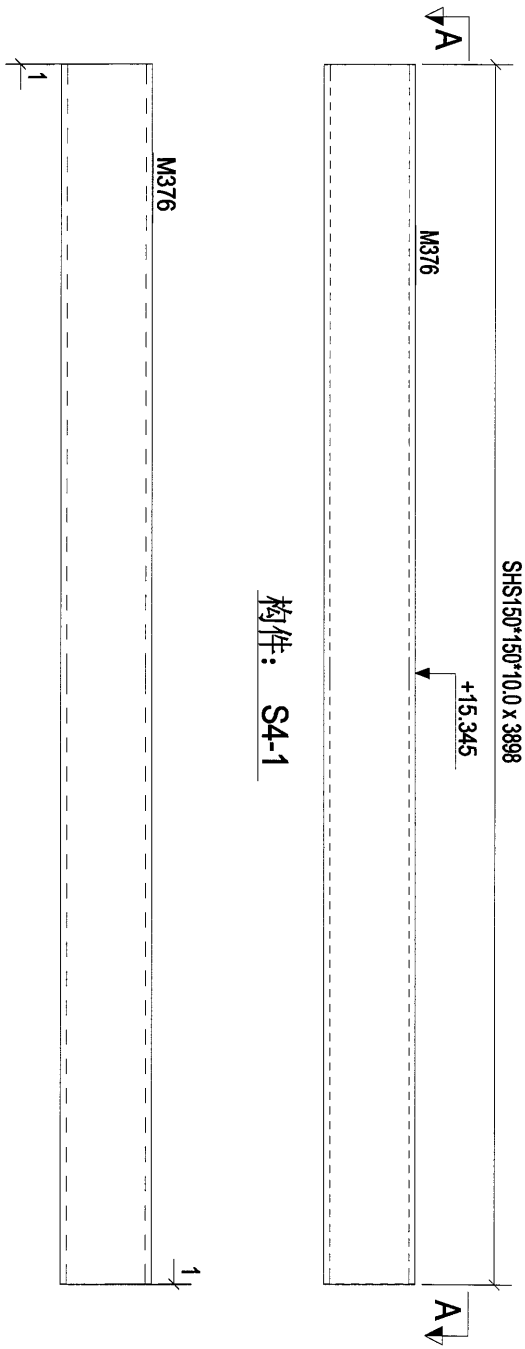

A - A

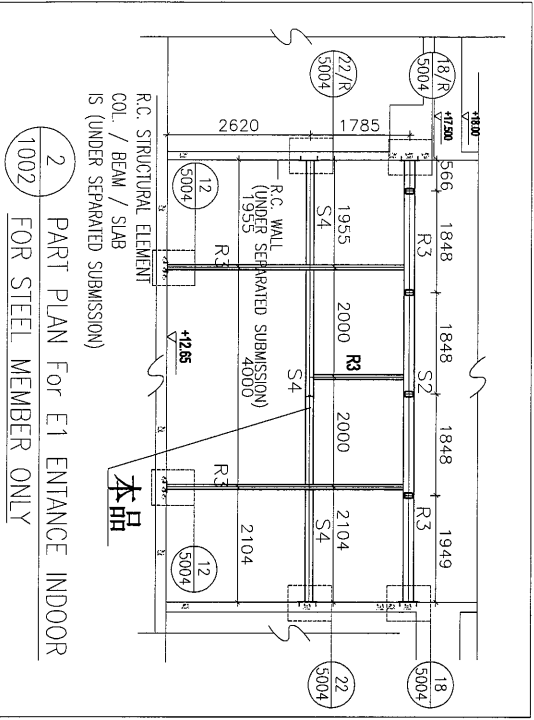

2 PART PLAN FOR E1 ENTRANCE INDOOR FOR STEEL MEMBER ONLY

构件编号	规格(mm)	长度(mm)	数量	单重(kg)	共重(kg)	表面积(m ²)
M376	SHS150*150*10.0	3898	1	167.99	167.99	2.24
合计:				167.99		

Rev.	Description	Date
A	第2次报批	2019-01-05

PROJECT: PROPOSED SITE C1 DEVELOPMENT AT AREA A8, TAOJIAOPI, FUSONG KWANAO, NEW TERRITORIES

CLIENT: 基特經貿有限公司
MIDI Automotive Associates Ltd.
Units 6-8, Sunny Industrial Centre, 1/F
610 Chee Kwo Ling Road, Kowloon
Tel: (852) 9211-14 Fax: (852) 7727666

设计有限公司
MIDI ENGINEERING LIMITED

[S4-1]

Designated by	Reviewed by	Approved by	Scale	DWG. NO.	REV.
				E1	A

SHS150*150*10.0 x 1510

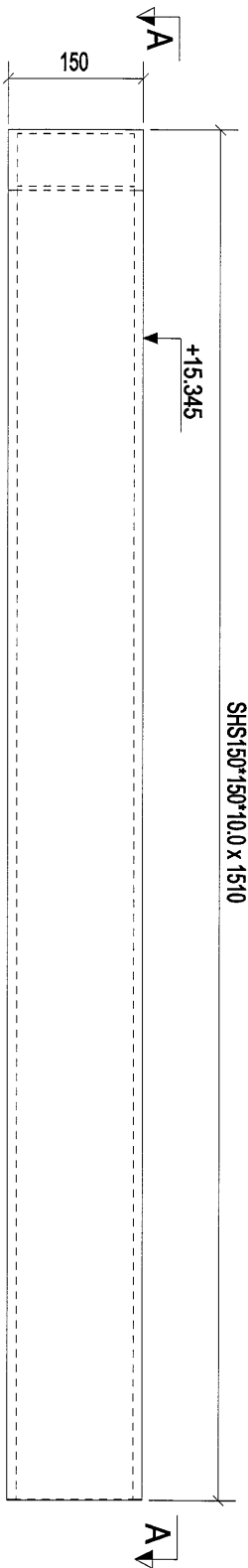

构件: S4-2

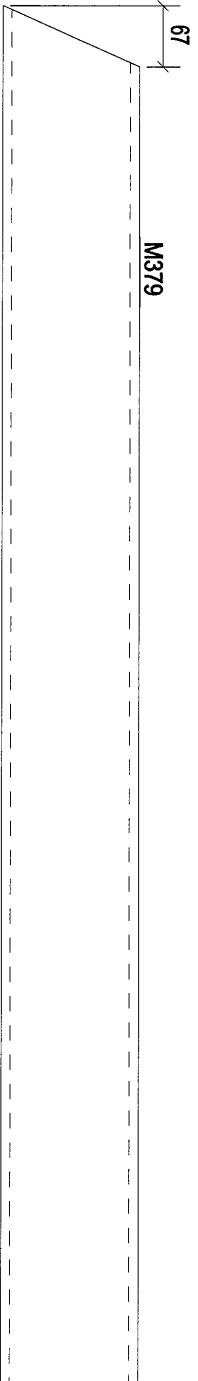

A - A

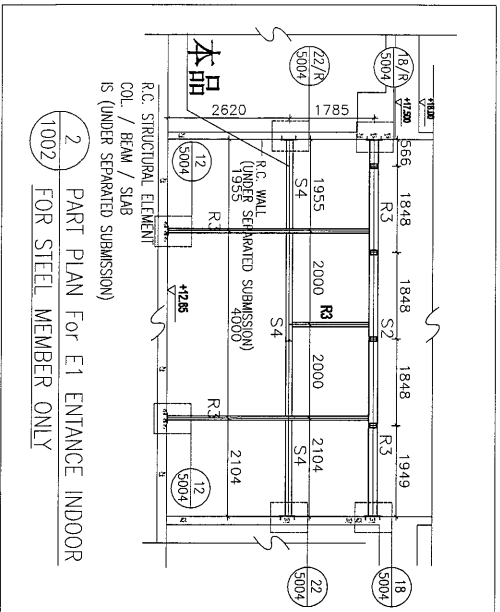

构件编号	规格(mm)	长度(mm)	数量	单重(kg)	共重(kg)	表面积(m ²)
M379	SHS150*150*10.0	1510	1	65.06	65.06	0.87
合计:				65.06		

Rev.	A	第2次设计	2019-01-05
Description	PROJECT: PROPOSED SITE C1 DEVELOPMENT AT JAGA 06, KOTL'ORP' TSEUNG KWAN'O, NEW TERRITORIES		
Date	CLIENT: 華特經貿有限公司 MIDICOMMERCE (HONG KONG) LTD. 610 Chin Kwo Ling Road, Kowloon. Tel: 23489211-4 Fax: (852) 27272565		
 捷昌工程 捷昌工程有限公司 10001001 Limited			
Designed by	[S4-2]		
Drawn by			
Reviewed by			
Approved by			
Scale			
DWG NO.	E1	-	[S4-2]
REV.	A		

126

127

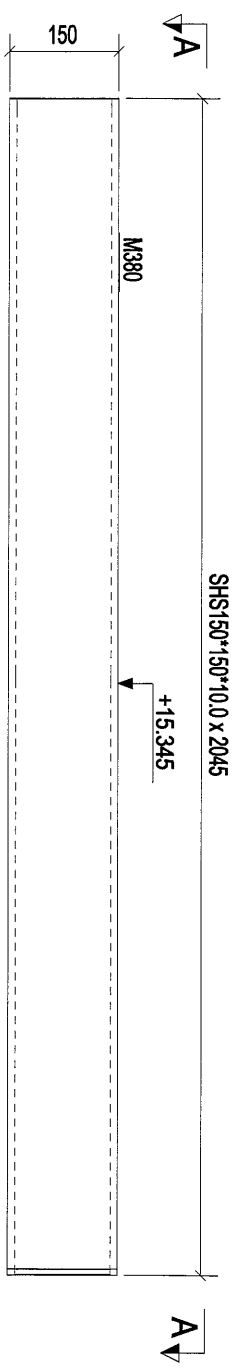

构件: S4-3

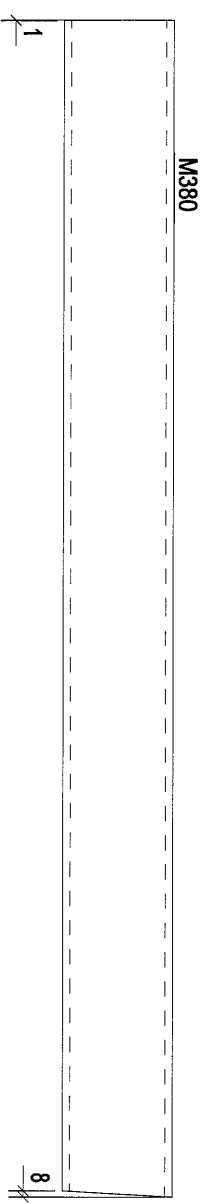

A - A

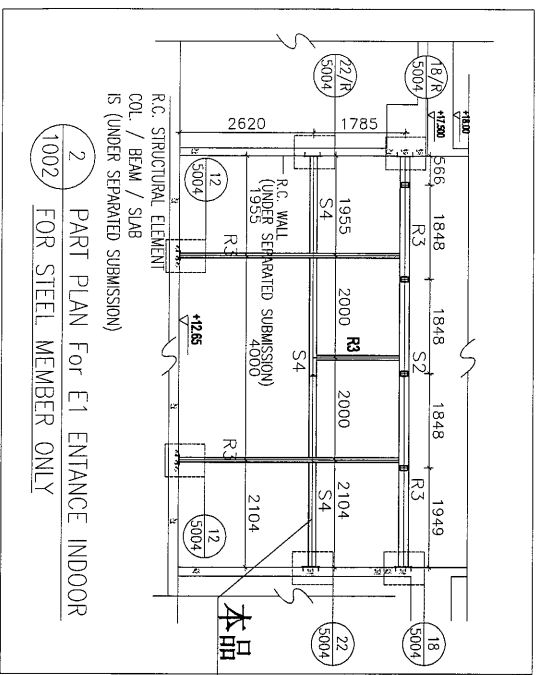

2 PART PLAN FOR E1 ENTRANCE INDOOR FOR STEEL MEMBER ONLY

构件编号:	S4-3	构件数量:	1	构件重量:	88.14
规格(mm)	SHS150*150*10.0	长度(mm)	2045	共重(kg)	88.14
数量	1	单重(kg)	88.14	表面积(m ²)	1.17
合计:			88.14		

CLIENT:	美特经贸有限公司 MIDI International Units 6-8, Sunray Industrial Centre, 1/F 610 Chee Kwo Ling Road, Kowloon Tel: 23489211-4 Fax: (852) 27275656	
PROJECT:	PROPOSED SITE C1 DEVELOPMENT AT AREA NO. TKOIL TOWER TISEMS KWANLO NEW TERRITORIES	
Rev.	Description	Date
A	第2次提批	2019-01-05
 捷昇工程有限公司 G.P. Engineering Limited		
Designed by		
Drawn by		
Reviewed by		
Approved by		
Scale		
DWG NO.:	E1	- [S4-3]
REV.	A	

128

RSA40*40*4 x 1743

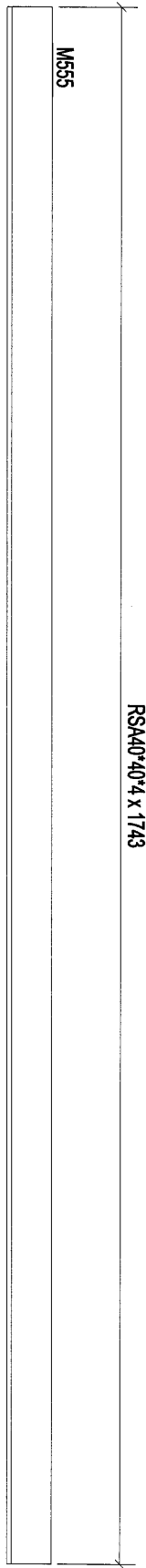

构件: S7-1

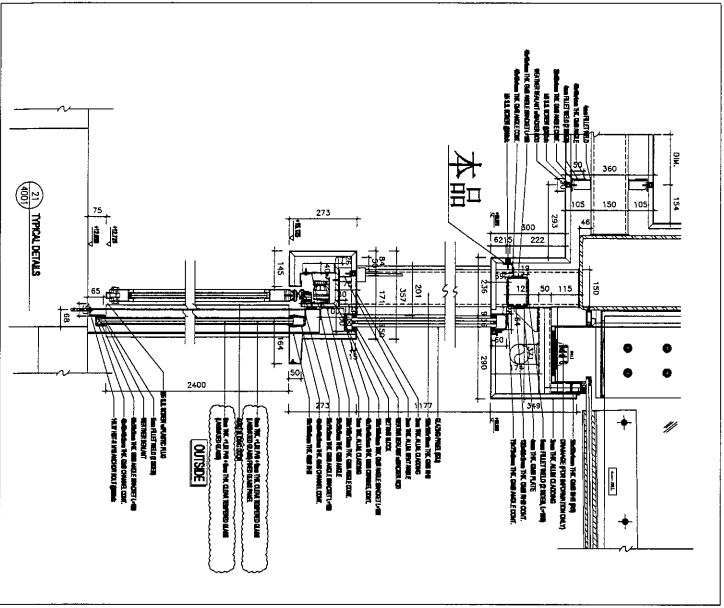

构件编号	规格(mm)	长度(mm)	数量	单重(kg)	共重(kg)	表面积(m ²)
M555	RSA40*40*4	1743	1	4.23	4.23	0.28
合计:					4.23	

Rev	Description	Date
0	第一次报数	2019-01-05

PROJECT:
 PROPOSED SITE C1
 DEVELOPMENT AT AREA 8,
 TAOLO TOWN, TSEUNG KUN MAN,
 NEW TERRITORIES

CLIENT:
美特经贸有限公司
 MIDT (MIDTOWN) DEVELOPMENT LTD.
 Units 6-8, Sunny Industrial Centre, 1/F
 610 Chee Kwo Ling Road, Kowloon
 Tel: 23489211-4 Fax: (852) 27276665



[S7-1]

Designed by	
Drawn by	
Reviewed by	
Approved by	
Scale	
DWGNO: E1	- S7-1
REV:	0

130

RSAA40*40*4 x 1200

M557

构件: S7-3

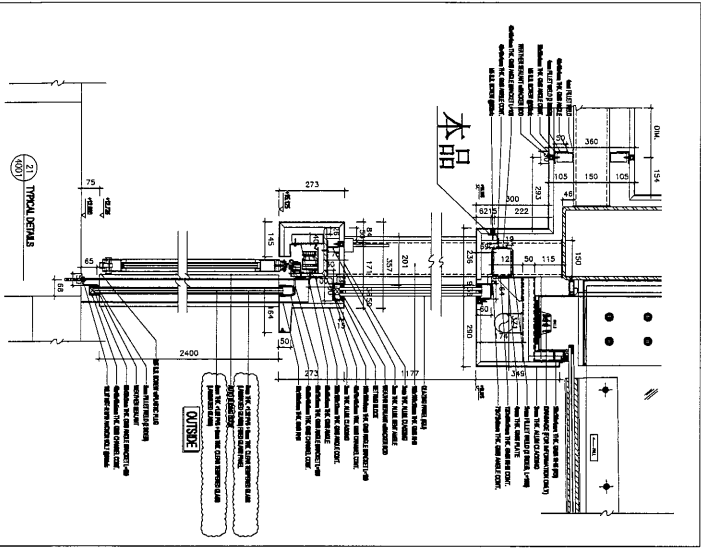

构件编号	规格(mm)	长度(mm)	数量	单重(kg)	构件重量	表面积(m ²)
M557	RSAA40*40*4	1200	1	2.91	2.91	0.19
合计:					2.91	

0	第一次报批	2019-01-05
Rev.	Description	Date

PROJECT: PROPOSED SITE C1
 DEVELOPMENT IN AREA 88,
 TAOLEI TOWN, SHANGHAI
 NEW TERRITORIES

CLIENT: 美特经贸有限公司
 MIDT ANTONING TRADING CO., LTD.
 Unit 6-8, Sunny Industrial Centre, 1/F,
 610 Chu Kuo Ling Road, Kowloon
 Tel: 23489211-4 Fax: (852) 2727666



[S7-3]

Designed by	
Drawn by	
Reviewed by	
Approved by	
Scale	
DWG NO: E1	- [S7-3]
REV:	0

131

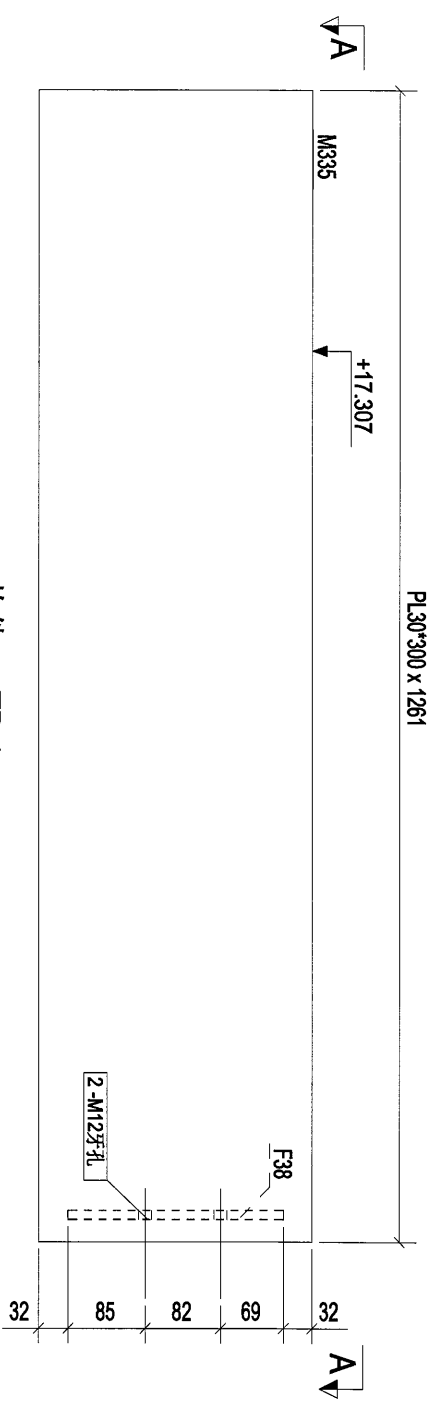

构件: TB-1

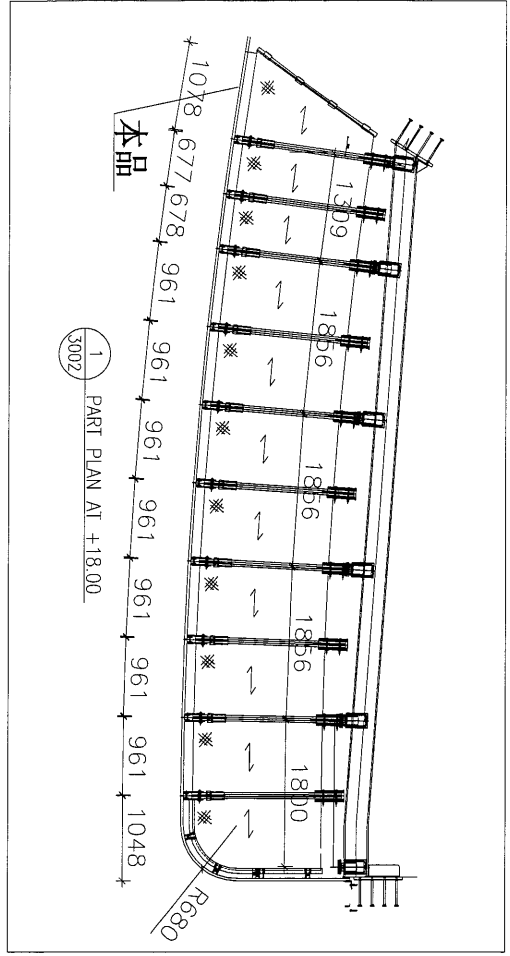
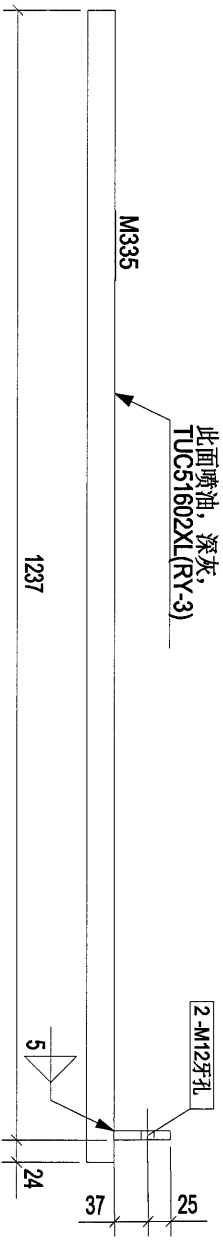

构件编号	TB-1	规格(mm)	长度(mm)	数量	数量	单重(kg)	共重(kg)	表面积(m ²)
F38	PLT10*62	236	1	1	1.15	1.15	0.04	
M335	PL30*300	1261	1	1	89.07	89.07	0.85	
合计:							90.22	

CLIENT:	 美特經貿有限公司 MIDU <small>International Business Centre Ltd.</small> Units 5-8, Sunny Industrial Centre, 1/ 610 Cheong Cheong Road, Kowloon Tel: 23489211-4 Fax: (852) 27272666		
PROJECT:	PROPOSED SITE C1 DEVELOPMENT AT RICA 08, TOLTUON, TSEDING RIVANNO, NEW TERRITORIES		
Rev.	A	第2次报批	2019-01-05
Designed by			
Drawn by			
Reviewed by			
Approved by			
Scale			
DWG NO.	E1	-	TB-1
REV.	A		

132

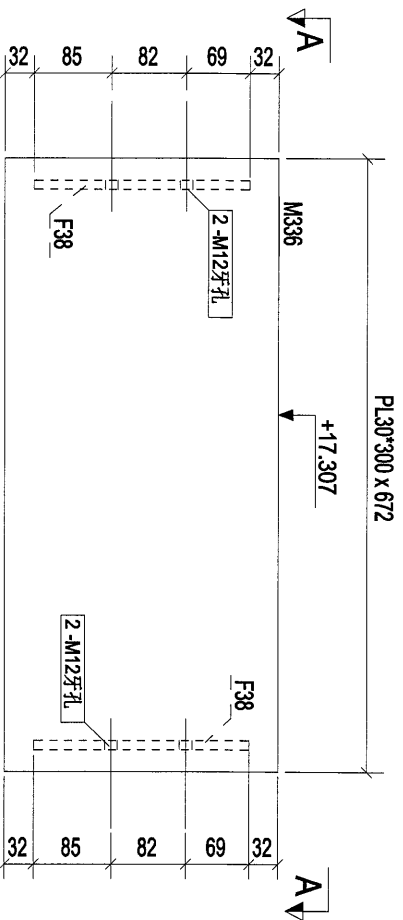

构件: TB-2

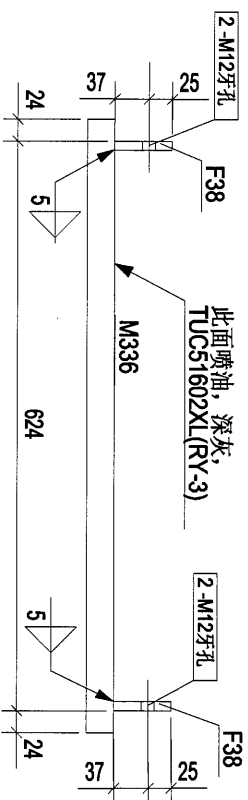

A - A

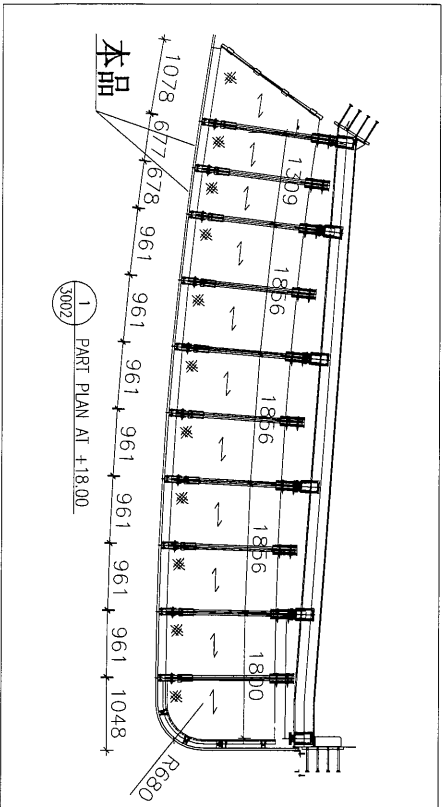

1/3002 PART PLAN AT +18.00

构件编号	规格(mm)	长度(mm)	数量	单重(kg)	共重(kg)	表面积(m ²)
F38	PLT10*62	236	2	1.15	2.30	0.04
M336	PL30*300	672	1	47.50	47.50	0.46
合计:					49.80	

Designed by		Drawn by	
Reviewed by		Approved by	
Scale		DWG NO:	E1 - TB-21
REV.	A		

PROJECT	PROPOSED SITE C1 DEVELOPMENT AT FARGA RD, KOTI, TIRUPATI, TAMIL NADU, NEW TERRITORIES
CLIENT	華特鋁質有限公司 MIDI Aluminium Products 510 Chin Kuo Ling Road, Kowloon Tel: 23492711-4 Fax: (852) 27272666



華特鋁質有限公司
 MIDI Aluminium Products
 510 Chin Kuo Ling Road, Kowloon
 Tel: 23492711-4 Fax: (852) 27272666

[TB-2]

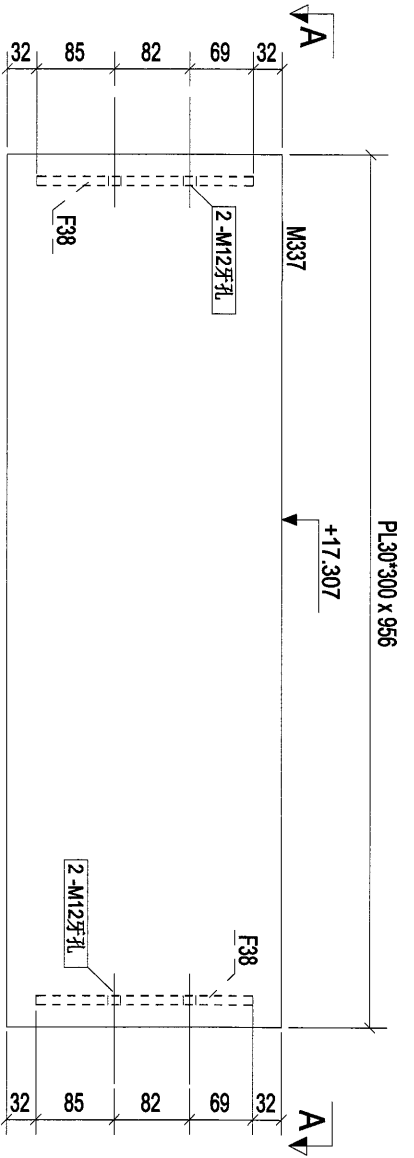
133

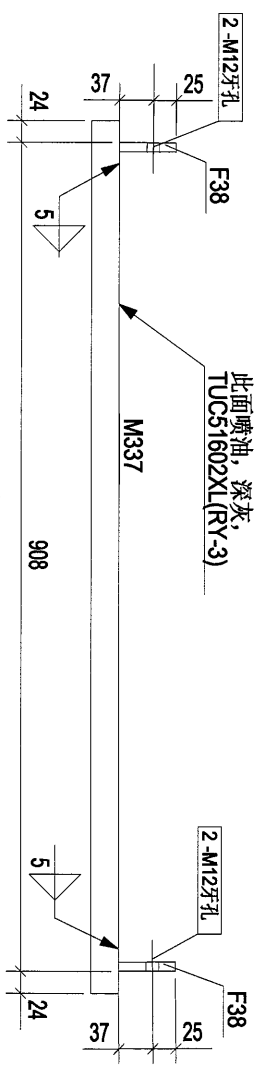

构件: TB-3



A - A

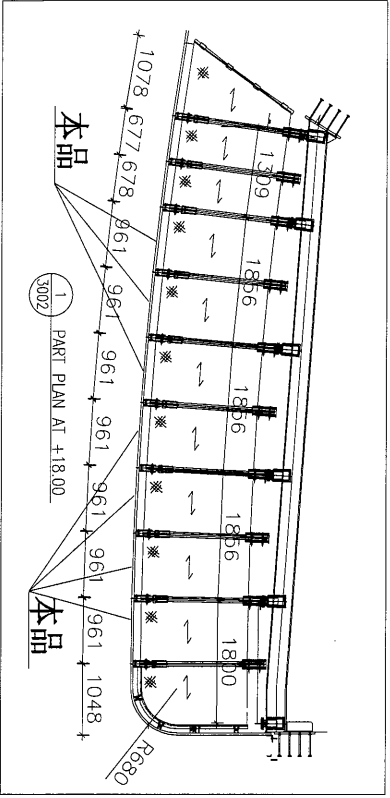

构件编号	规格(mm)	长度(mm)	数量	单重(kg)	共重(kg)	表面积(m ²)
F38	PLT10*62	236	2	1.15	2.30	0.04
M337	PL30*300	956	1	67.54	67.54	0.65
合计:					69.84	

CLIENT:	 美特经贸有限公司 MIDU AMUNING TRADECO. LTD. 610 Che Kwo Ling Road, Kowloon Tel: 23489211-4 Fax: (852) 27272666		
PROJECT:	PROPOSED SITE C1 DEVELOPMENT AT KACHAU, TAOI TOI V.P., ISLAND HONGKONG, NEW TERRITORIES		
Rev:	A	第2次报批	2019-01-05
Design by	Designed by		
Drawn by	Drawn by		
Reviewed by	Reviewed by		
Approved by	Approved by		
Scale	Scale		
DWG NO.:	E1	- TB-3J	REV. A



祖國行有限公司
 91 WING LOK AN LIMITED

[TB-3J]

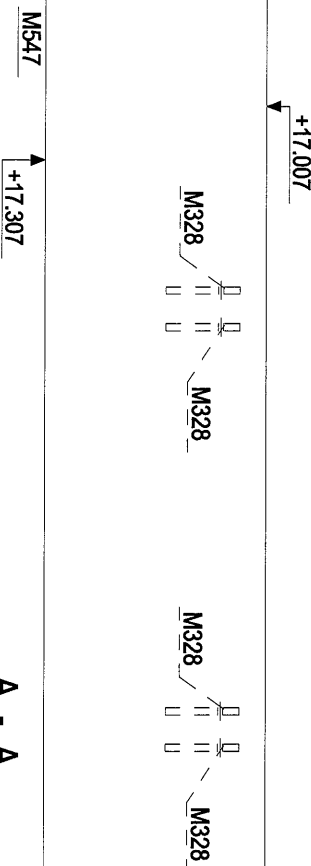
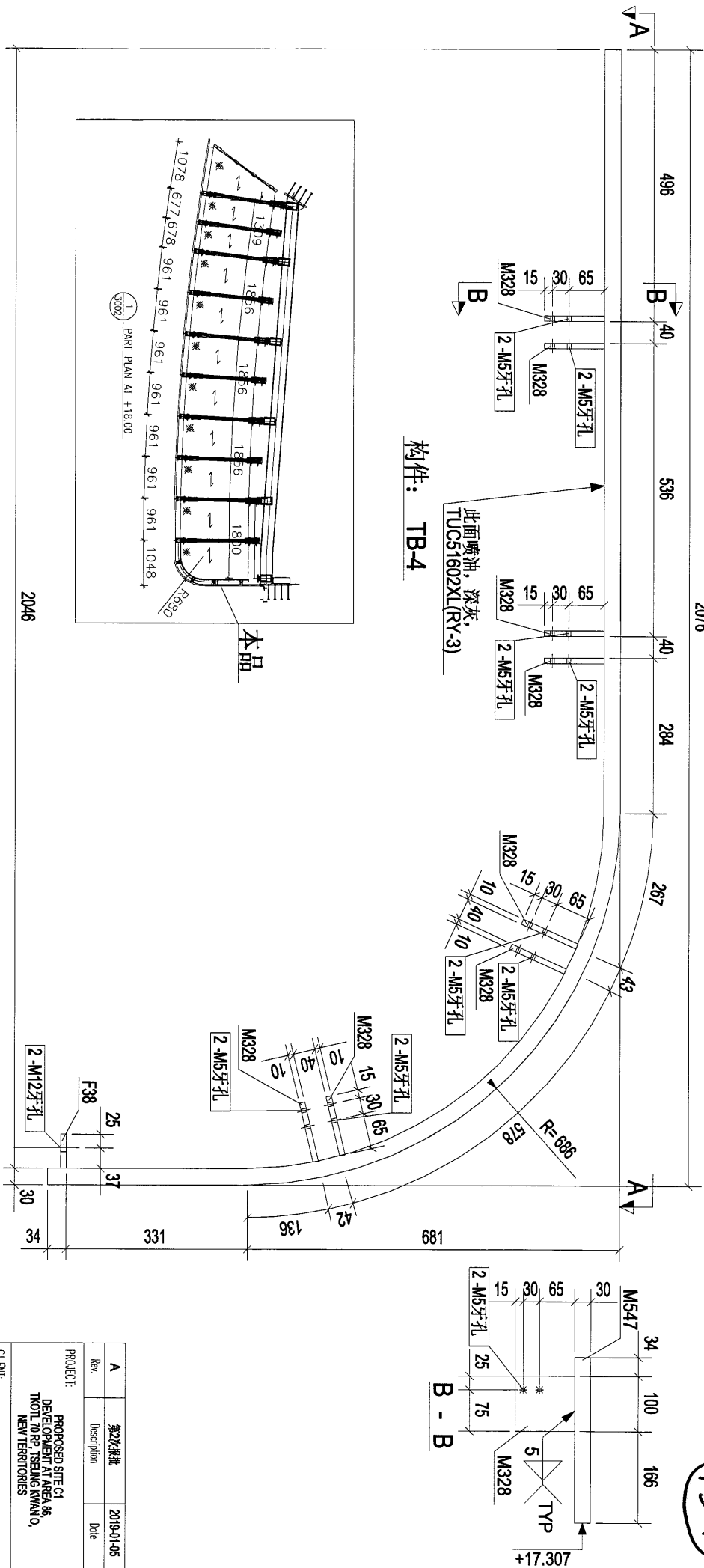

零件编号	规格(mm)	长度(mm)	数量	单重(kg)	共重(kg)	表面积(m²)
M328	PL10*62	236	1	1.15	1.15	0.04
M328	PL10*100	110	8	0.86	6.91	0.03
M547	PL30*300	2780	1	198.15	198.15	1.87
合计:				206.21		

Rev	Description	Date
A	第一次提批	2019-01-05

CLIENT: 美特鋁質有限公司
 MIDT Aluminium Associates Ltd.
 Unit 6-8, Sunny Industrial Centre, 1/F
 610 Chee Kwo Ling Road, Kowloon
 Tel: (854) 9271-4 Fax: (852) 2727686

PROJECT: PROPOSED SITE C1
 DEVELOPMENT AT AREA 86
 TSOI TO PEI TSEUNG KWAN O,
 NEW TERRITORIES

Drawn by
 Reviewed by
 Approved by
 Scale

DWG NO: E1 - [TB-4]
 REV A

134