

工程指示 / 要求簡箋(E.I.)

工程指示編號：EI 6085/16 修改版次： /
 工程編號：J835 工程名稱：TK0118 平台
 工程項目：幕牆、玻璃牆、鋁柵格、鋁摺件 — 確認、模具圖紙
 收件人：羅小姐 發件人：Eddie 日期：2016.10.19
 X85366 - X85383, X85385 - X85389, X85392 - X85397

要求提供 / 確認 事項：

- | | | |
|-----------------------------------------------------|-------------------------------------|-------------------------------|
| <input type="checkbox"/> 初步鋁料 B.M. | <input type="checkbox"/> 加工拆圖，然後生產 | <input type="checkbox"/> 尺寸表 |
| <input type="checkbox"/> 正式鋁料 B.M. | <input type="checkbox"/> 技術上資料 / 指示 | <input type="checkbox"/> 報價 |
| <input type="checkbox"/> 配件 B.M. | <input type="checkbox"/> 樣辦或貨品說明書 | <input type="checkbox"/> 分判合約 |
| <input checked="" type="checkbox"/> 其他： <u>模具圖紙</u> | | |

內容：

現確認 模具圖紙 X85366 - X85383, X85385 - X85389
X85392 - X85397 (共 29 個)

請提供 300mm 長鋁辦供確認

請在 2016.10.20 前完成上列要求。

附有關圖紙 / 文件：

1+2P6

以上項目為：

- 原合約工程包 原合約工程加 / 減脹 新工程報價

原因：-

分發東莞各部門：

- () 生產技術總監 連附件 () 技術部 連附件 () 生產部 連附件 () 機械設計部 連附件
 () 採購部 連附件 () 生產統籌部 連附件
 () 質檢部 連附件 () 會計部 連附件 () 報關組 連附件 () 其他 連附件

分發香港各部門：

- () 行政部 連附件 () 會計部 連附件 () 統籌部 連附件 () 工程部地盤科文 連附件
 () 採購部 連附件 () QS 部 連附件 () 維修部 連附件 () 其他 連附件

傳遞編號：

HK 2279/16 (FTP)

發件人簽署：

Eddie 2016.10.19

項目經理簽署：

CUSTOMER	HONGKONG CO.	CUSTOMER APPROVAL	CUST PART NO.	X85366
			SECTION NO.	LH0088204

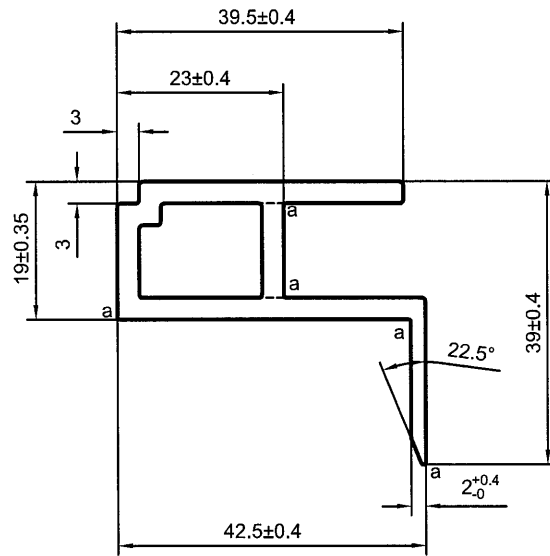

美特鋁質有限公司	
承認圖面	<i>[Signature]</i>
日期	19/10/16

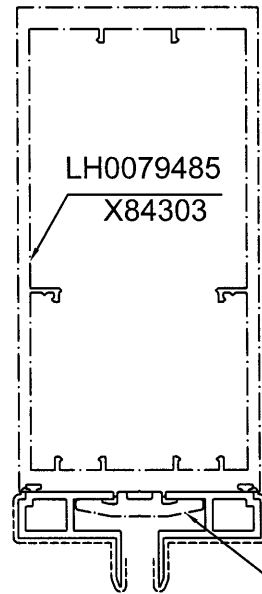
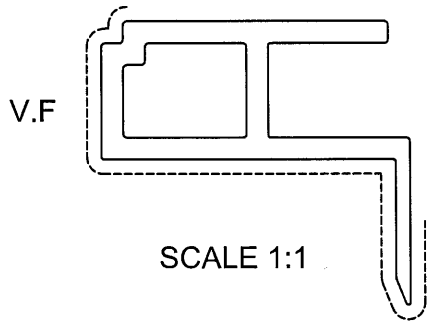

a=R0.3

*配合尺寸以实物配合效果为准!

SIGNATURE GRADEING	HIGH SIGNATURE GRADEING	C.C.DIA(MM)	Ø 55.37		SCALE 1:3				
AREA (SQ MM)	361.28 (383.55)	UNSPECIFIED THICKNESS	3 ^{+0.4} / ₋₀	PERIMETER (MM)	192.8	STANDARD	GB 5237.1	SCALE	1:1
MASS (KG/M)	1.039	UNSPECIFIED CORNERS	R 0.5	SURFACE AREA	94.20	ALLOY	6063-T6	VERSION	A
COMPANY ISSUE		A	DRAWN	蔡晓巡	DATE	2016-10-06	APPELLATION	-	PAGE OF
			STANDARDIZATION		DATE				
			TO SIGN	陈国提	DATE				
			AUDITING		DATE				
MARKER	MODIFY	FILE NO	SIGNATURE	DATE	APPROV				

PANASIA ALUMINUM (CHINA) LIMITED

CUSTOMER	HONGKONG CO.	CUSTOMER APPROVAL	CUST PART NO.	X85367
			SECTION NO.	LH0088205

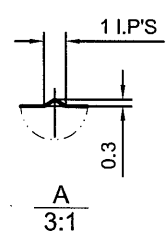
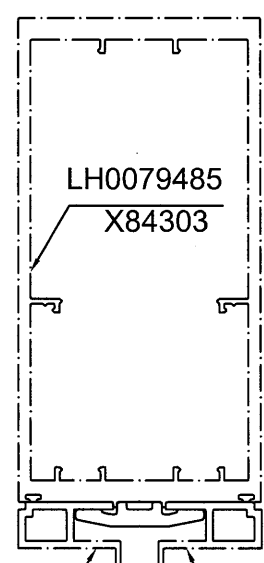
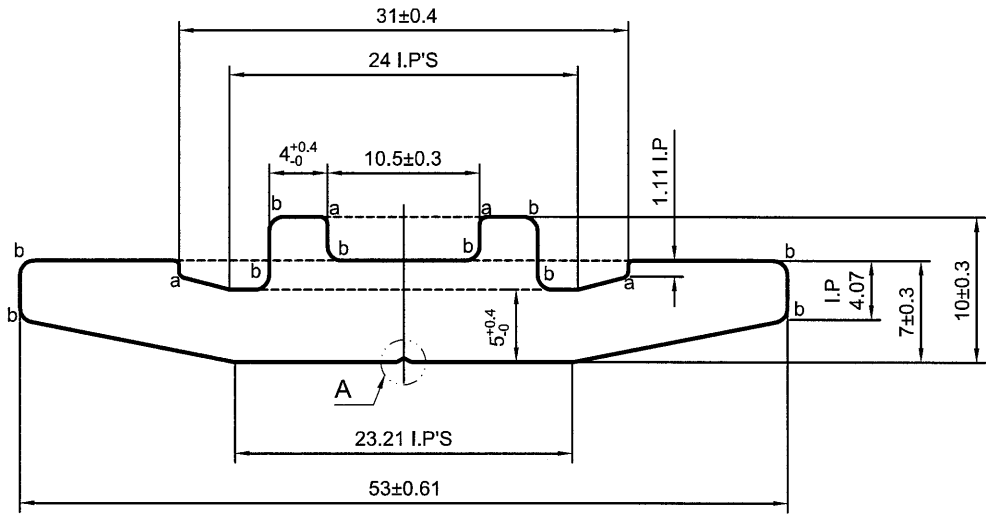

英特鋁質有限公司
承認圖面
日期 19/10/16

a=R0.5
b=R1.0

LH0088204 X85366 LH0088204 X85366

SCALE 1:2

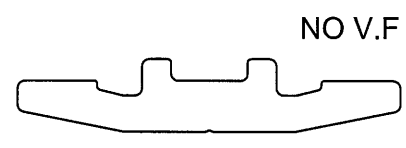

SCALE 1:1

*配合尺寸以实物配合效果为准!

SIGNATURE GRADEING	HIGH SIGNATURE GRADEING	C.C.DIA(MM)	Ø 53.05						
AREA (SQ MM)	328.95 (332.13)	UNSPECIFIED THICKNESS		PERIMETER (MM)	128.42	STANDARD	GB 5237.1	SCALE	2:1
MASS (KG/M)	0.9	UNSPECIFIED CORNERS	R 0.3	SURFACE AREA		ALLOY	6063-T6	VERSION	A
COMPANY ISSUE		A	DRAWA	蔡晓巡	DATE	2016-10-06	APELLATION	-	PAGE OF
			STANDA-RDIZATION		DATE				
			TO SIGN	陈国提	DATE				
			AUDITING		DATE				
MARKER	MODIFY	FILE NO	SIGNATURE	DATE	APPROV	DATE			

PANASIA ALUMINUM (CHINA) LIMITED

CUSTOMER	HONGKONG CO.	CUSTOMER APPROVAL	CUST PART NO.	X85368
			SECTION NO.	LH0088206

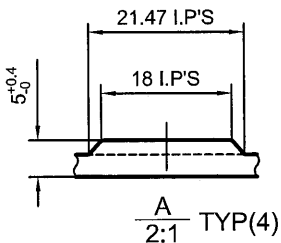
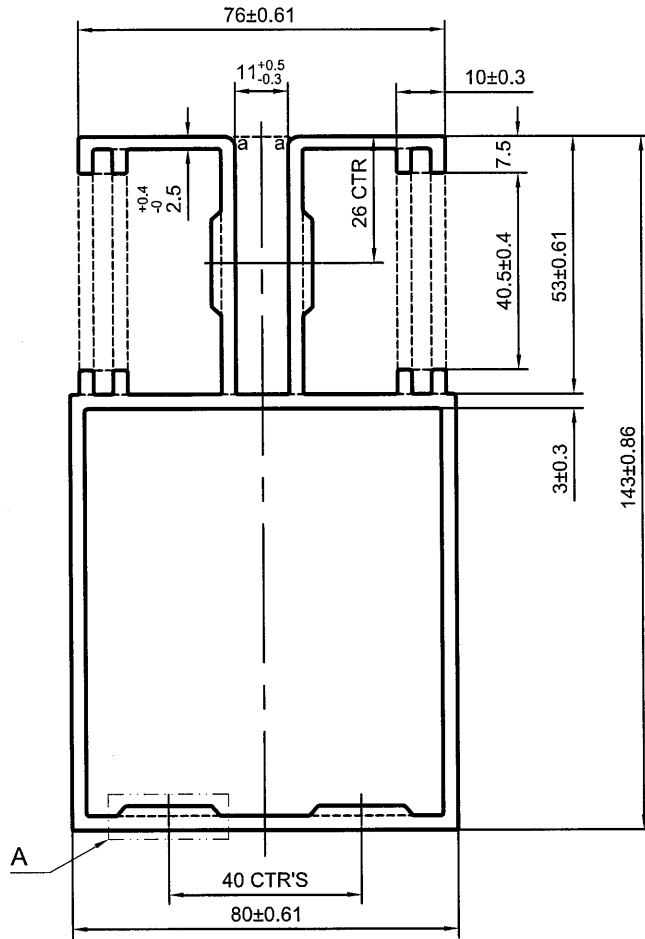

a=R 2

英特鋁質有限公司
承認圖面
日期 19/10/16

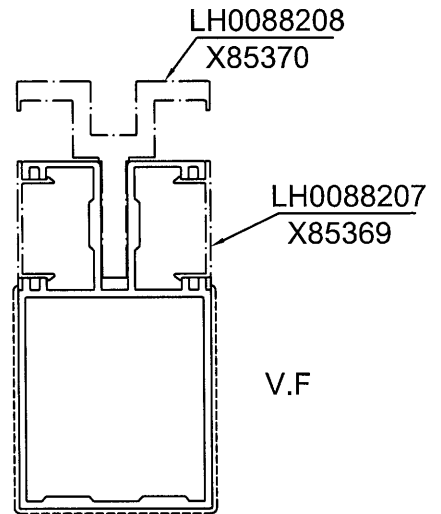

SCALE 1:3

*配合尺寸以实物配合效果为准!

SIGNATURE GRADEING	HIGH SIGNATURE GRADEING	C.C.DIA(MM)	Ø 162.55		SCALE 1:3				
AREA (SQ MM)	1725.74 (1826.14)	UNSPECIFIED THICKNESS	3+0.4/-0	PERIMETER (MM)	742.7	STANDARD	GB 5237.1	SCALE	1:1.5
MASS (KG/M)	4.949	UNSPECIFIED CORNERS	R 0.5	SURFACE AREA	273.28	ALLOY	6063-T6	VERSION	A
COMPANY ISSUE		A	DRAWA	蔡晓巡	DATE	2016-10-06	APELLATION	-	PAGE OF
			STANDA-RDIZATION		DATE				
			TO SIGN	陈国提	DATE				
			AUDITING		DATE				
MARKER	MODIFY	FILE NO	SIGNATURE	DATE	APPROV				

 PANASIA ALUMINUM (CHINA) LIMITED

4

CUSTOMER	HONGKONG CO.	CUSTOMER APPROVAL	CUST PART NO.	X85369
			SECTION NO.	LH0088207

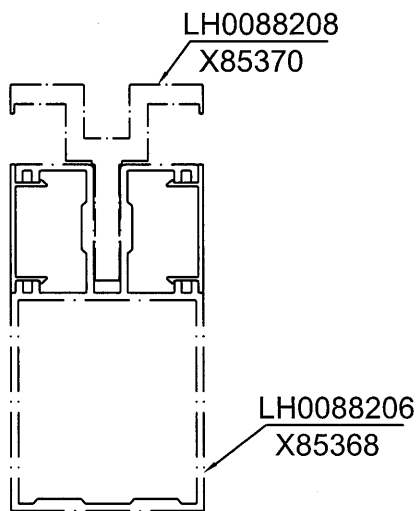
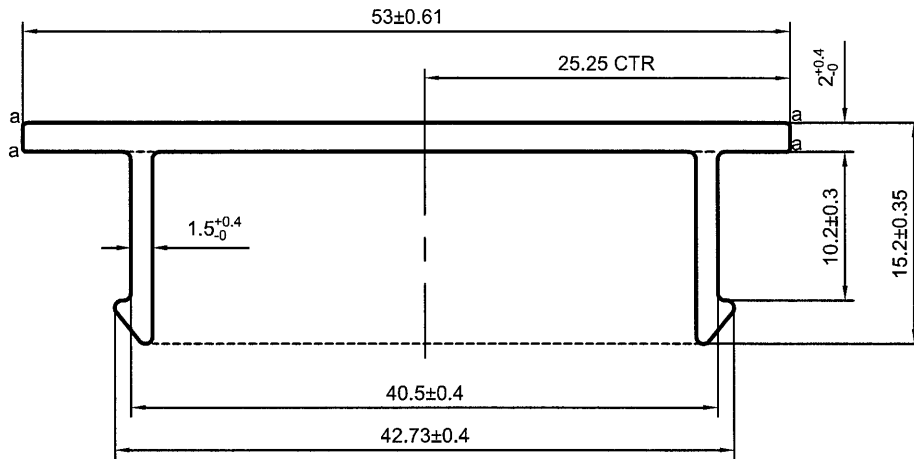

SCALE 1:3

a=R0.3

*配合尺寸以实物配合效果为准!

美特鋁質有限公司	
承認圖面	<i>[Signature]</i>
日期	19/10/16

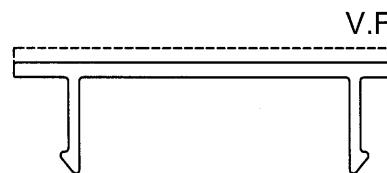

SCALE 1:1

SIGNATURE GRADEING	HIGH SIGNATURE GRADEING	C.C.DIA(MM)	Ø 53.02						
AREA (SQ MM)	147.89 (168.89)	UNSPECIFIED THICKNESS	PERIMETER (MM)	162.04	STANDARD	GB 5237.1	SCALE	2:1	
MASS (KG/M)	0.458	UNSPECIFIED CORNERS	R 0.5	SURFACE AREA	53.34	ALLOY	6063-T5	VERSION	A
COMPANY ISSUE		A	DRAWN	蔡晓巡	DATE	2016-10-06	APPELLATION	-	PAGE OF
			STANDARDIZATION		DATE				
			TO SIGN	陈国提	DATE				
			AUDITING		DATE				
MARKER	MODIFY	FILE NO	SIGNATURE	DATE	APPROV				

 PANASIA ALUMINUM (CHINA) LIMITED

5

CUSTOMER	HONGKONG CO.	CUSTOMER APPROVAL	CUST PART NO.	X85370
			SECTION NO.	LH0088208

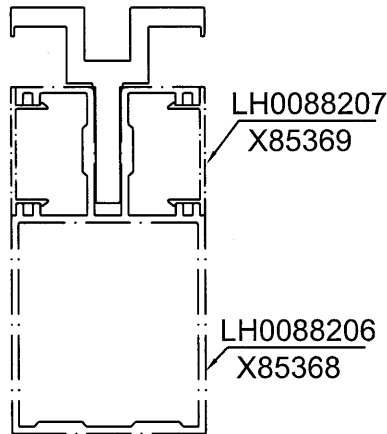
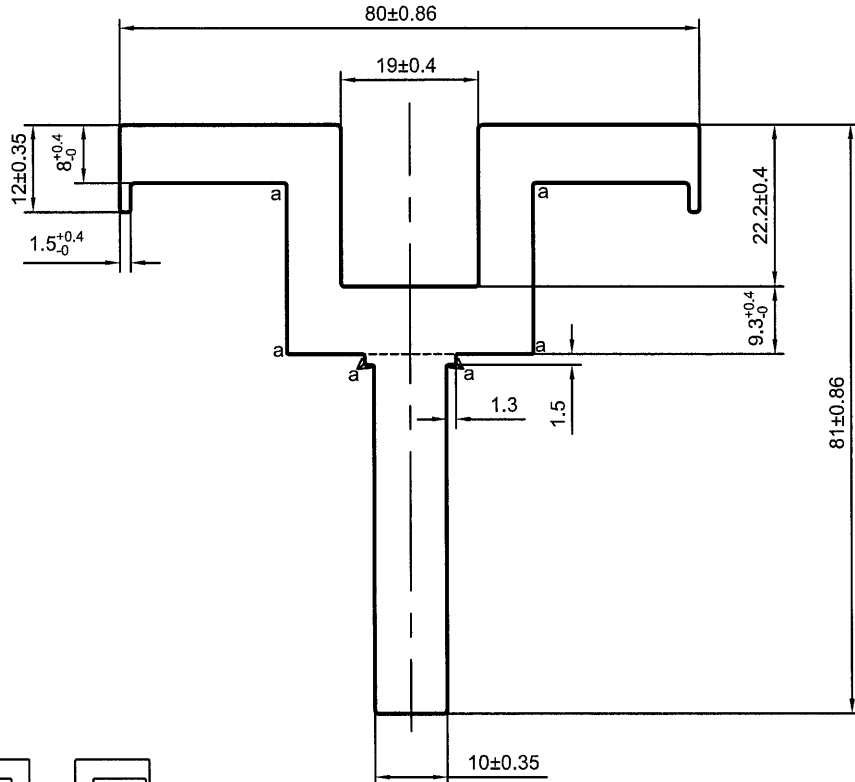

a=R0.3

SCALE 1:3

*配合尺寸以实物配合效果为准!

英特鋁質有限公司	
承認圖面	<i>Signature</i>
日期	19/10/16

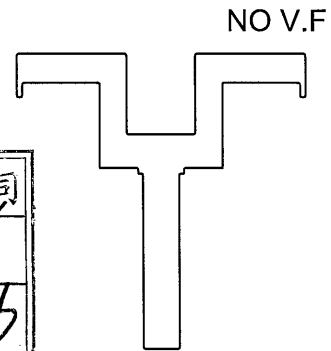

SCALE 1:2

SIGNATURE GRADEING	HIGH SIGNATURE GRADEING	C.C.DIA(MM)	Ø 100.66						
AREA (SQ MM)	1527.85 (1546.85)	UNSPECIFIED THICKNESS	7.5 ^{+0.4} ₋₀	PERIMETER (MM)	378.11	STANDARD	GB 5237.1	SCALE	1:1
MASS (KG/M)	4.192	UNSPECIFIED CORNERS	R 0.5	SURFACE AREA		ALLOY	6061-T6	VERSION	A
COMPANY ISSUE		A	DRAWA	蔡晓巡	DATE	2016-10-06	APELLATION	-	PAGE OF
			STANDA-RDIZATION		DATE				
			TO SIGN	陈国提	DATE				
			AUDITING		DATE				
MARKER	MODIFY	FILE NO	SIGNATURE	DATE	APPROV				

 PANASIA ALUMINUM (CHINA) LIMITED

CUSTOMER	HONGKONG CO.	CUSTOMER APPROVAL	CUST PART NO.	X85371
			SECTION NO.	LH0088209

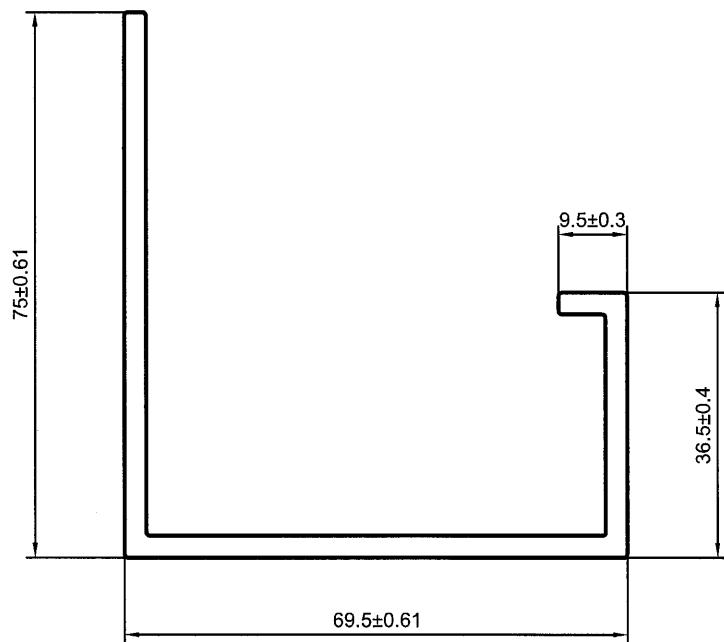

美特鋁質有限公司	
承認圖面	<i>[Signature]</i>
日期	19/10/16

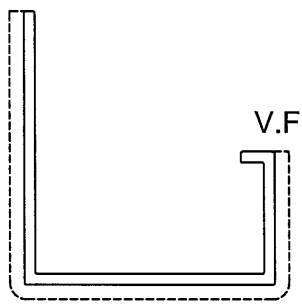

*配合尺寸以实物配合效果为准！

SCALE 1:2

SIGNATURE GRADEING	HIGH SIGNATURE GRADEING	C.C.DIA(MM)	Ø 101.84						
AREA (SQ MM)	544.29 (578.67)	UNSPECIFIED THICKNESS	3 ^{+0.4} ₋₀	PERIMETER (MM)	366.85	STANDARD	GB 5237.1	SCALE	1:1
MASS (KG/M)	1.568	UNSPECIFIED CORNERS	R 0.5	SURFACE AREA	181.14	ALLOY	6063-T6	VERSION	A
COMPANY ISSUE		A	DRAWA	蔡晓巡	DATE	2016-10-06	APELLATION	-	PAGE OF
			STANDA-RDIZATION		DATE				
			TO SIGN	陈国提	DATE				
			AUDITING		DATE				
MARKER	MODIFY	FILE NO	SIGNATURE	DATE	APPROV				

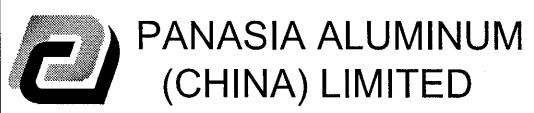

CUSTOMER	HONGKONG CO.	CUSTOMER APPROVAL	CUST PART NO.	X85372
			SECTION NO.	LH0088210

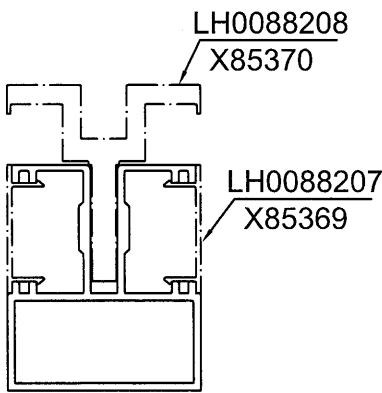
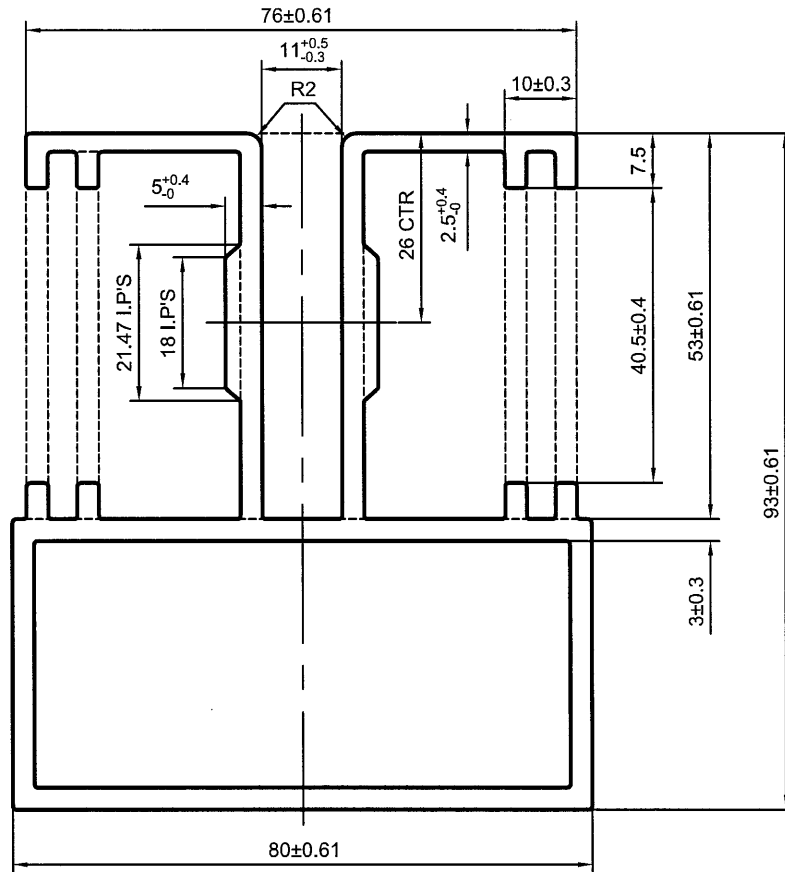

美特铝质有限公司	
承認圖面	<i>[Signature]</i>
日期	19/10/16

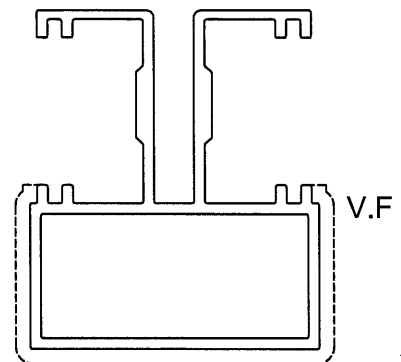

SCALE 1:3

*配合尺寸以实物配合效果为准!

SCALE 1:2

SIGNATURE GRADEING	HIGH SIGNATURE GRADEING	C.C.DIA(MM)	Ø 121						
AREA (SQ MM)	1346.81 (1428.49)	UNSPECIFIED THICKNESS	3+0.4/0	PERIMETER (MM)	642.7	STANDARD	GB 5237.1	SCALE	1:1
MASS (KG/M)	3.871	UNSPECIFIED CORNERS	R 0.5	SURFACE AREA	173.28	ALLOY	6063-T6	VERSION	A
COMPANY ISSUE		A	DRAWA	蔡晓巡	DATE	2016-10-06	APELLATION	-	PAGE OF
			STANDA-RDIZATION		DATE				
			TO SIGN	陈国提	DATE				
			AUDITING		DATE				
MARKER	MODIFY	FILE NO	SIGNATURE	DATE	APPROV				

PANASIA ALUMINUM (CHINA) LIMITED

CUSTOMER	HONGKONG CO.	CUSTOMER APPROVAL	CUST PART NO.	X85373
			SECTION NO.	LH0088211

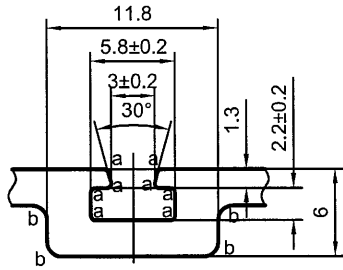

A
2:1 TYP(2)

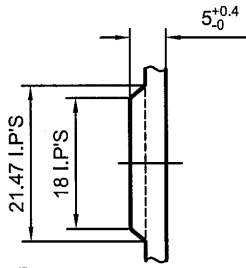

B
1:1 TYP(4)

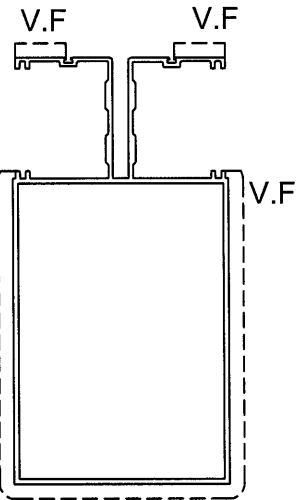
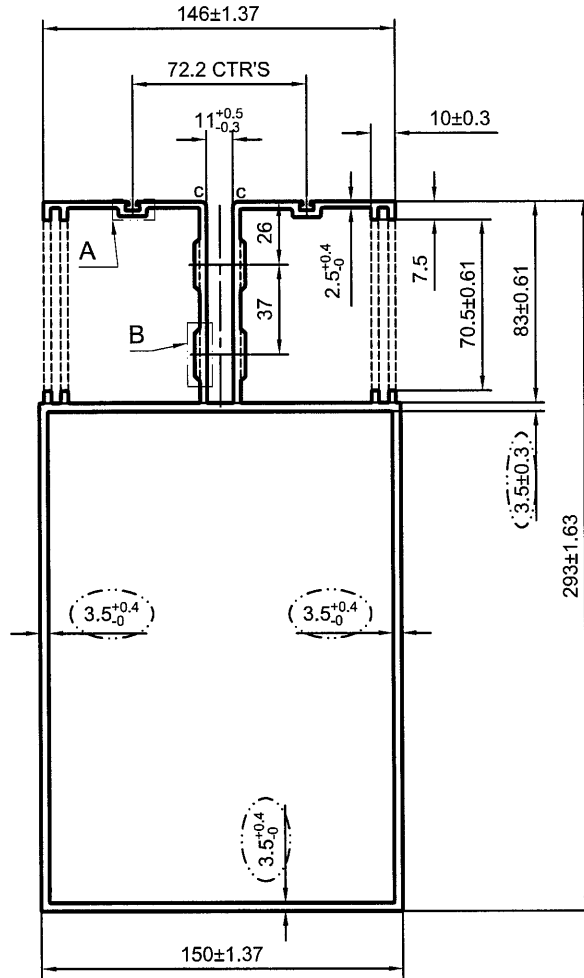

SCALE 1:5

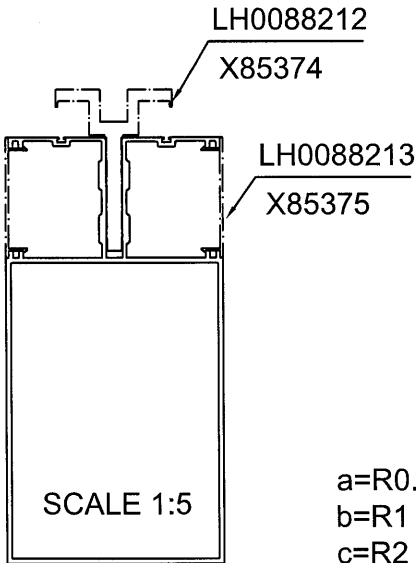

a=R0.3
b=R1
c=R2

*配合尺寸以实物配合效果为准!

美特鋁質有限公司	
承認圖面	<i>[Signature]</i>
日期	19/10/16

SIGNATURE GRADEING	HIGH SIGNATURE GRADEING	C.C.DIA(MM)	Ø 327.92						
AREA (SQ MM)	3633.32 (3812.01)	UNSPECIFIED THICKNESS	3+0.4/-0	PERIMETER (MM)	1419.18	STANDARD	GB 5237.1	SCALE	1:3
MASS (KG/M)	10.33	UNSPECIFIED CORNERS	R 0.5	SURFACE AREA	654.47	ALLOY	6063-T6	VERSION	A
COMPANY ISSUE		A	DRAWA	蔡晓巡	DATE	2016-10-06	APELLATION	-	PAGE OF
			STANDA-RDIZATION		DATE				
			TO SIGN	陈国提	DATE				
			AUDITING		DATE				
MARKER	MODIFY	FILE NO	SIGNATURE	DATE	APPROV	DATE			

PANASIA ALUMINUM (CHINA) LIMITED

9

CUSTOMER	HONGKONG CO.	CUSTOMER APPROVAL	CUST PART NO.	X85374
			SECTION NO.	LH0088212

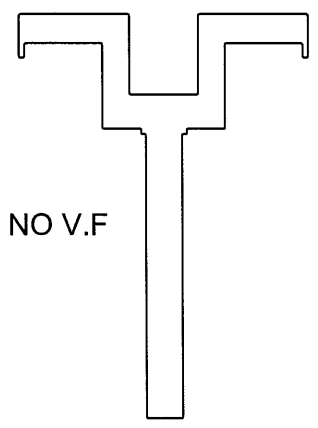
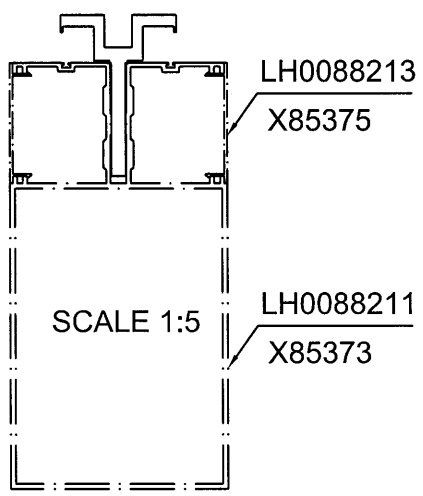
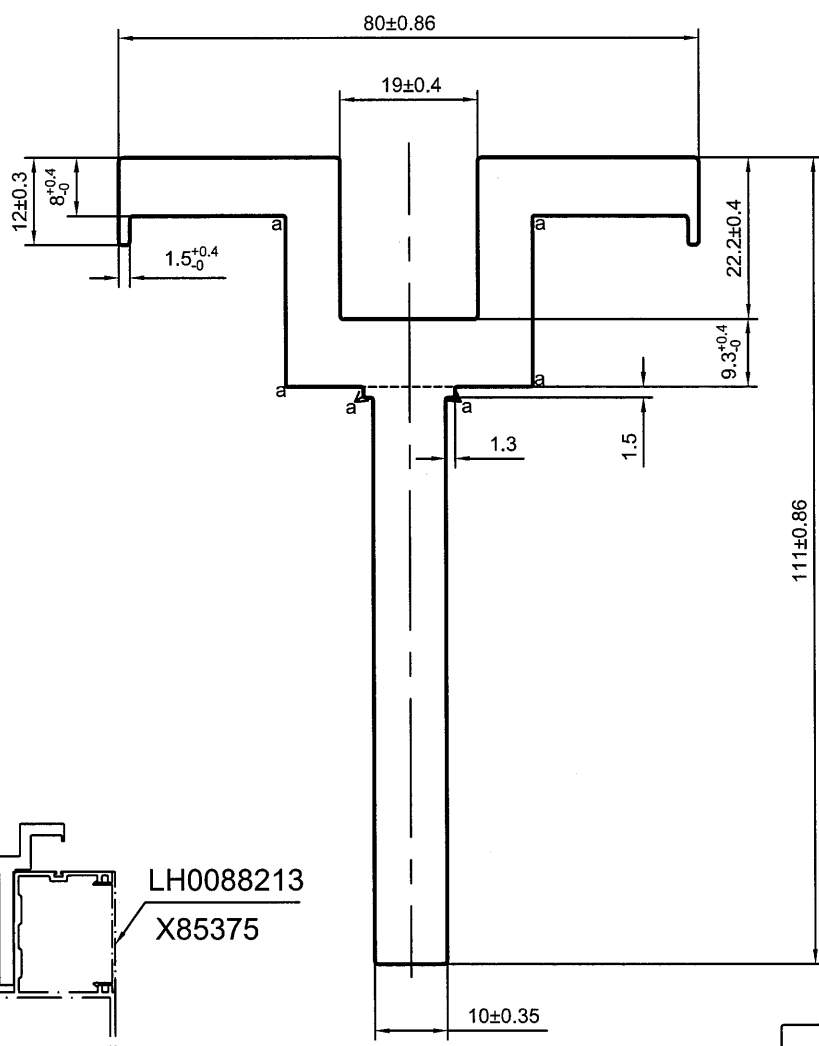

美特鋁質有限公司
承認圖面
日期 9/10/16

a=R0.3
*配合尺寸以实物配合效果为准!

SIGNATURE GRADEING	HIGH SIGNATURE GRADEING	C.C.DIA(MM)	Ø 125.33						
AREA (SQ MM)	1827.84 (1850.56)	UNSPECIFIED THICKNESS	7.5 ^{+0.4} ₋₀	PERIMETER (MM)	438.11	STANDARD	GB 5237.1	SCALE	1:1
MASS (KG/M)	5.015	UNSPECIFIED CORNERS	R 0.5	SURFACE AREA		ALLOY	6061-T6	VERSION	A
COMPANY ISSUE		A	DRAWA	蔡晓巡	DATE	2016-10-06	APELLATION	-	PAGE OF
			STANDA-RDIZATION		DATE				
			TO SIGN	陈国提	DATE				
			AUDITING		DATE				
MARKER	MODIFY	FILE NO	SIGNATURE	DATE	APPROV	DATE			

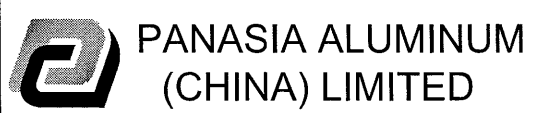

CUSTOMER	HONGKONG CO.	CUSTOMER APPROVAL	CUST PART NO.	X85375
			SECTION NO.	LH0088213

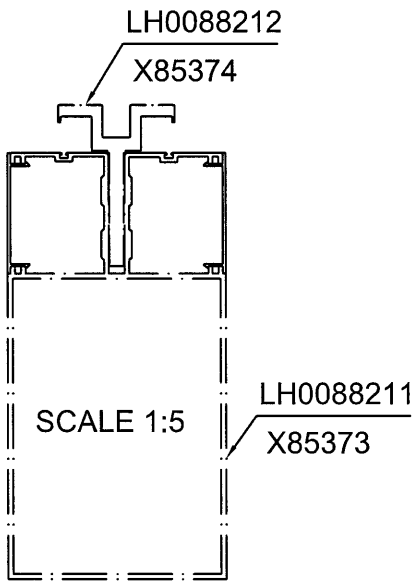
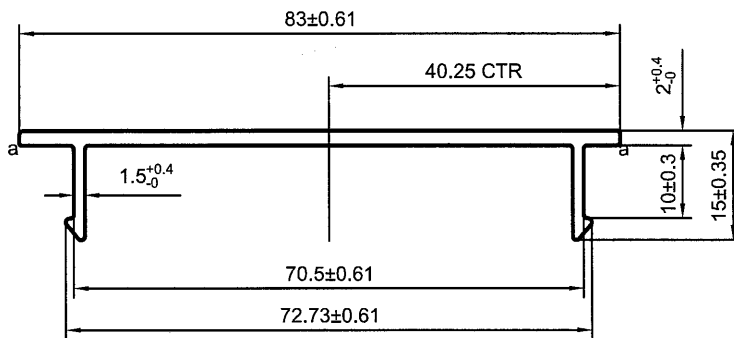

美特鋁質有限公司	
承認圖面	<i>[Signature]</i>
日期	19/10/16

NO V.F

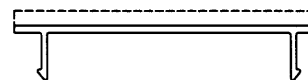

SCALE 1:2

a=R0.3

*配合尺寸以实物配合效果为准!

SIGNATURE GRADEING	HIGH SIGNATURE GRADEING	C.C.DIA(MM)	Ø 83.01						
AREA (SQ MM)	207.26 (228.3)	UNSPECIFIED THICKNESS		PERIMETER (MM)	221.15	STANDARD	GB 5237.1	SCALE	1:1
MASS (KG/M)	0.619	UNSPECIFIED CORNERS	R 0.5	SURFACE AREA	83.46	ALLOY	6063-T5	VERSION	A
COMPANY ISSUE		A	DRAWA	蔡晓巡	DATE	2016-10-06	APELLATION	-	PAGE OF
			STANDA-RDIZATION		DATE				
			TO SIGN	陈国提	DATE				
			AUDITING		DATE				
MARKER	MODIFY	FILE NO	SIGNATURE	DATE	APPROV	DATE			

11

CUSTOMER	HONGKONG CO.	CUSTOMER APPROVAL	CUST PART NO.	X85376
			SECTION NO.	LH0088214

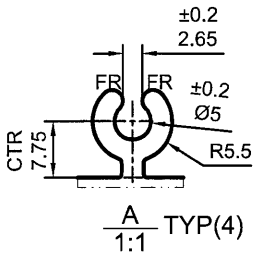
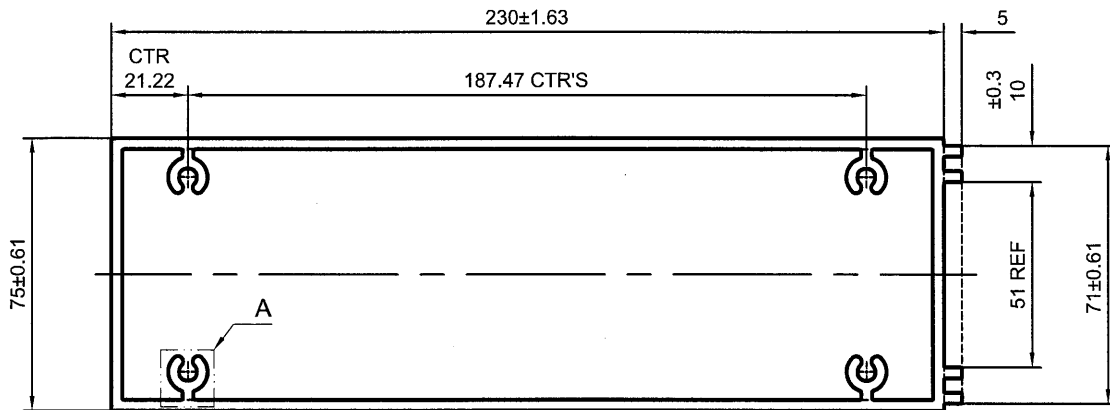

英特鋁質有限公司
承認圖面
日期 19/10/16

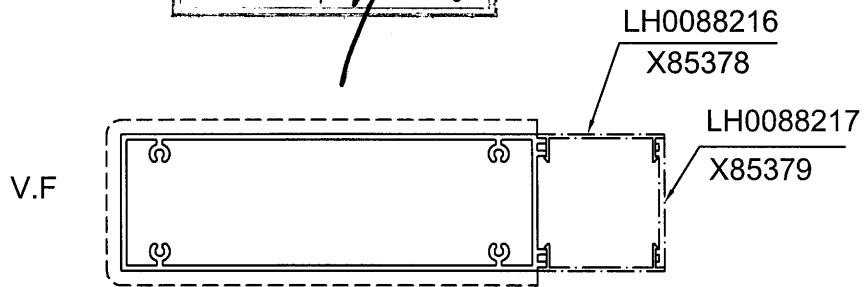

*配合尺寸以实物配合效果为准!

SCALE 1:4

SIGNATURE GRADEING	HIGH SIGNATURE GRADEING	C.C.DIA(MM)	Ø 245.84						
AREA (SQ MM)	2136.95 (2255.59)	UNSPECIFIED THICKNESS	3 ^{+0.4} ₋₀	PERIMETER (MM)	645.71	STANDARD	GB 5237.1	SCALE	1:2
MASS (KG/M)	6.113	UNSPECIFIED CORNERS	R 0.5	SURFACE AREA	535.14	ALLOY	6063-T6	VERSION	A
COMPANY ISSUE		A	DRAWA	蔡晓巡	DATE	2016-10-07	APELLATION	-	PAGE OF
			STANDARDIZATION		DATE				
			TO SIGN	陈国提	DATE				
			AUDITING		DATE				
MARKER	MODIFY	FILE NO	SIGNATURE	DATE	APPROV	DATE			

 PANASIA ALUMINUM (CHINA) LIMITED

12

CUSTOMER	HONGKONG CO.	CUSTOMER APPROVAL	CUST PART NO.	X85377
			SECTION NO.	LH0088215

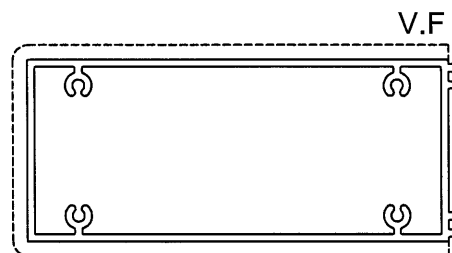
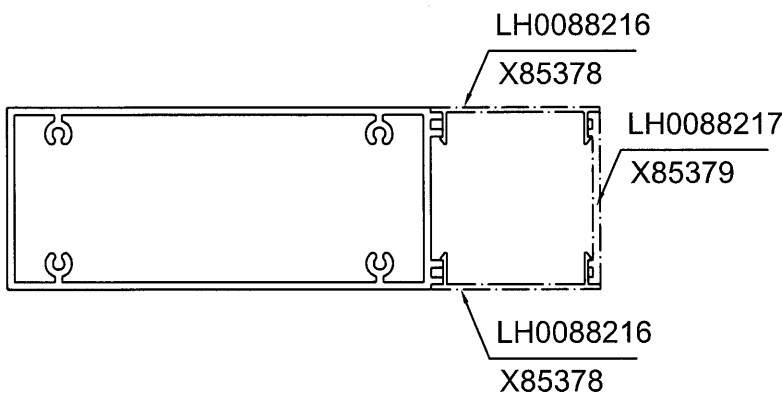
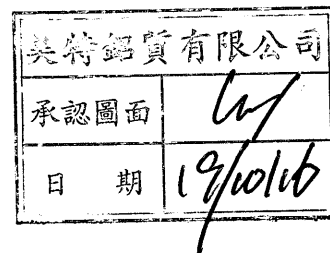
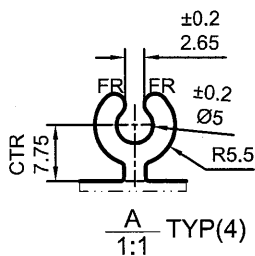
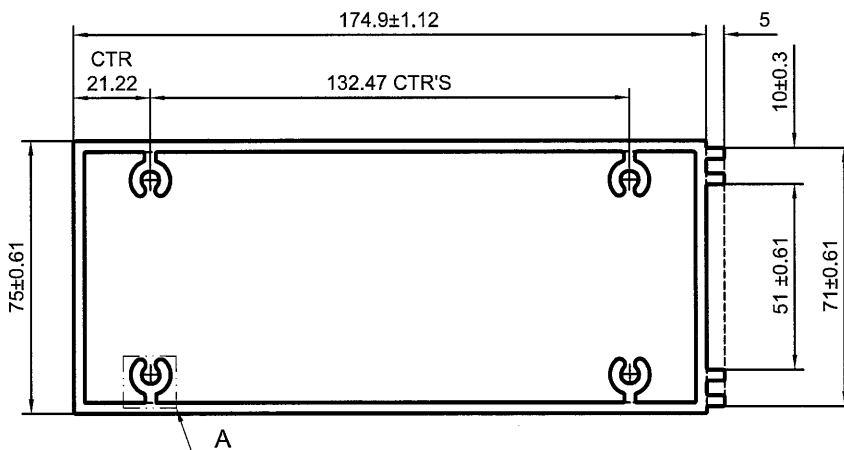

*配合尺寸以实物配合效果为准!

SCALE 1:3

SIGNATURE GRADEING	HIGH SIGNATURE GRADEING	C.C.DIA(MM)	Ø 193.86						
AREA (SQ MM)	1806.35 (1902.95)	UNSPECIFIED THICKNESS	3 ^{+0.4} ₋₀	PERIMETER (MM)	535.51	STANDARD	GB 5237.1	SCALE	1:2
MASS (KG/M)	5.157	UNSPECIFIED CORNERS	R 0.5	SURFACE AREA	424.94	ALLOY	6063-T6	VERSION	A
COMPANY ISSUE		A	DRAWA	蔡晓巡	DATE	2016-10-07	APPELLATION	-	PAGE OF
			STANDA-RDIZATION		DATE				
			TO SIGN	陈国提	DATE				
			AUDITING		DATE				
MARKER	MODIFY FILE NO	SIGNATURE	DATE	APPROV	DATE				

CUSTOMER	HONGKONG CO.	CUSTOMER APPROVAL	CUST PART NO.	X85378
			SECTION NO.	LH0088216

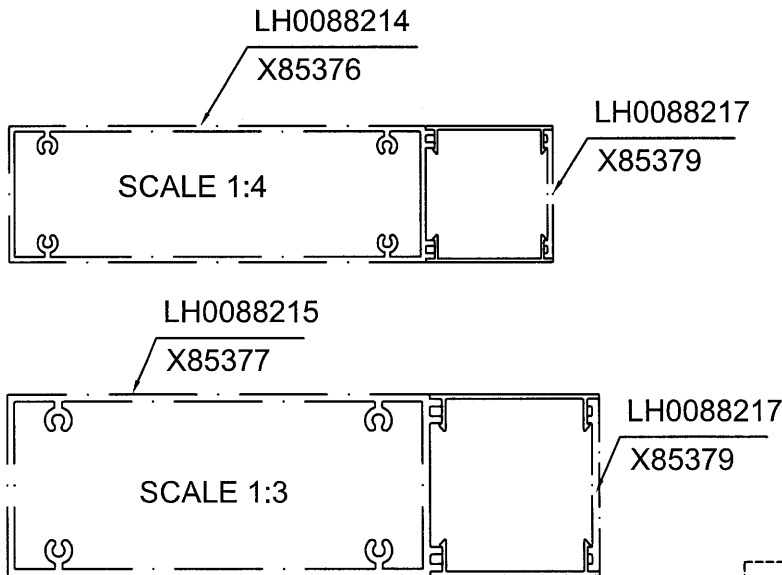
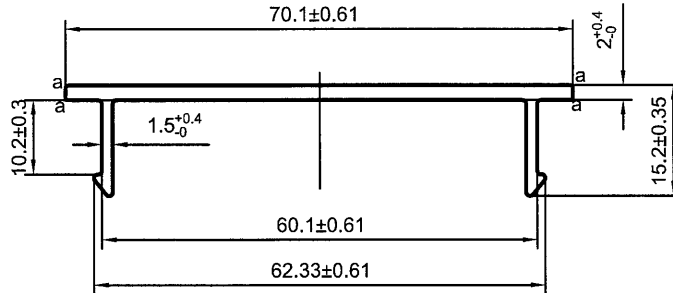

英特鋁質有限公司	
承認圖面	<i>[Signature]</i>
日期	<i>19/10/16</i>

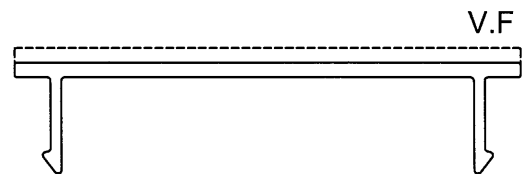

a=R0.3

*配合尺寸以实物配合效果为准!

SIGNATURE GRADEING	HIGH SIGNATURE GRADEING	C.C.DIA(MM)	Ø 70.11		SCALE 1:1				
AREA (SQ MM)	182.09 (199.63)	UNSPECIFIED THICKNESS	PERIMETER (MM)	196.24	STANDARD	GB 5237.1	SCALE	1:1	
MASS (KG/M)	0.541	UNSPECIFIED CORNERS	R 0.5	SURFACE AREA	70.44	ALLOY	6063-T5	VERSION	A
COMPANY ISSUE		A	DRAWA	蔡晓巡	DATE	2016-10-07	APELLATION	-	PAGE OF
			STANDA-RDIZATION		DATE				
			TO SIGN	陈国提	DATE				
			AUDITING		DATE				
MARKER	MODIFY	FILE NO	SIGNATURE	DATE	APPROV				

 PANASIA ALUMINUM (CHINA) LIMITED

14

CUSTOMER	HONGKONG CO.	CUSTOMER APPROVAL	CUST PART NO.	X85379
			SECTION NO.	LH0088217

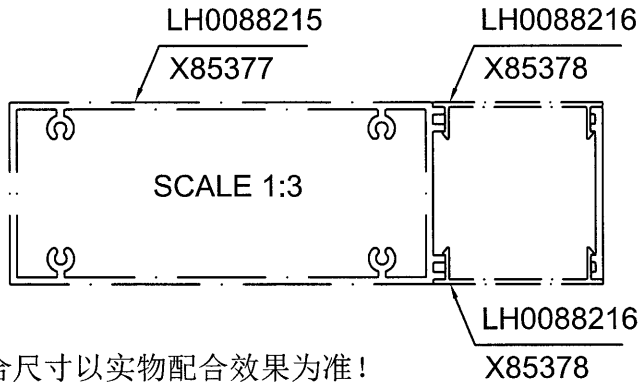
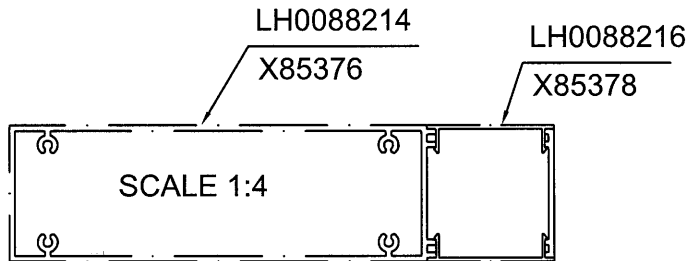
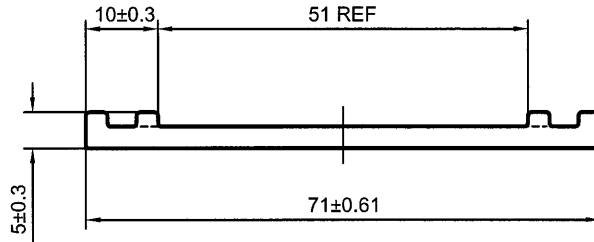

美特鋁質有限公司	
承認圖面	<i>[Signature]</i>
日期	19/10/16

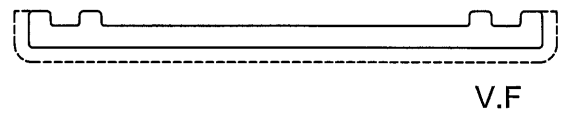

*配合尺寸以实物配合效果为准!

X85378

SCALE 1:1

SIGNATURE GRADEING	HIGH SIGNATURE GRADEING	C.C.DIA(MM)	Ø71.11						
AREA (SQ MM)	236.78 (250.02)	UNSPECIFIED THICKNESS	3 ^{+0.4} ₋₀	PERIMETER (MM)	160.57	STANDARD	GB 5237.1	SCALE	1:1
MASS (KG/M)	0.678	UNSPECIFIED CORNERS	R 0.5	SURFACE AREA	81.14	ALLOY	6063-T5	VERSION	A
COMPANY ISSUE		A	DRAWA	蔡晓巡	DATE	2016-10-07	APELLATION	-	PAGE OF
			STANDA-RDIZATION		DATE				
			TO SIGN	陈国提	DATE				
			AUDITING		DATE				
MARKER	MODIFY	FILE NO	SIGNATURE	DATE	APPROV	DATE			

18

CUSTOMER	HONGKONG CO.	CUSTOMER APPROVAL	CUST PART NO.	X85380
			SECTION NO.	LH0088218

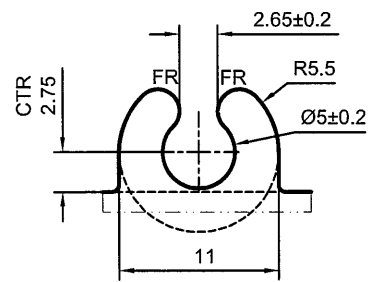
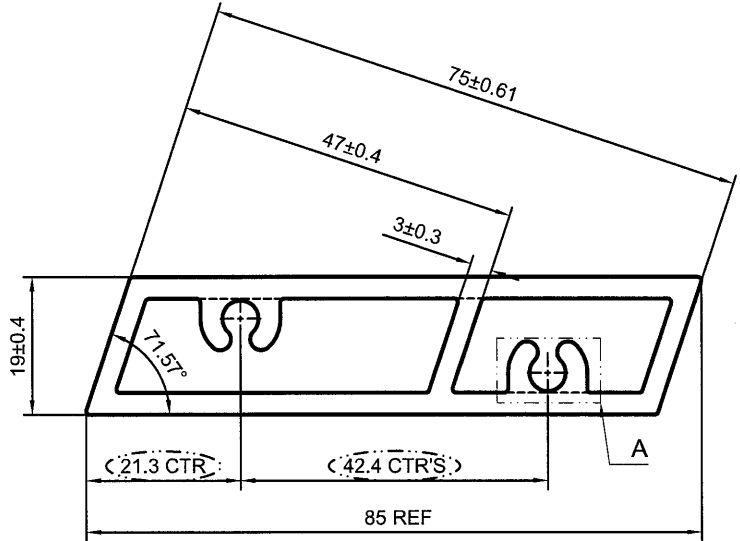

A
2:1 TYP(2)

美特鋁質有限公司	
承認圖面	<i>[Signature]</i>
日期	19/10/16

V.F

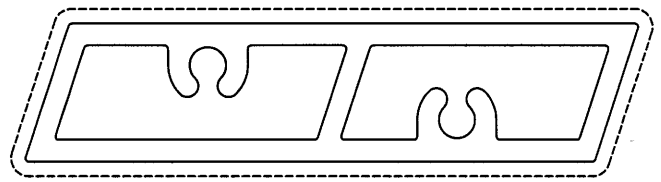

*配合尺寸以实物配合效果为准!

SCALE 1:1

SIGNATURE GRADEING	HIGH SIGNATURE GRADEING	C.C.DIA(MM)	Ø 86.9						
AREA (SQ MM)	690.52 (721.9)	UNSPECIFIED THICKNESS	3 ^{+0.4} ₋₀	PERIMETER (MM)	197.04	STANDARD	GB 5237.1	SCALE	1:1
MASS (KG/M)	1.956	UNSPECIFIED CORNERS	R 0.5	SURFACE AREA	197.04	ALLOY	6063-T6	VERSION	A
COMPANY ISSUE		A	DRAWA	蔡晓巡	DATE	2016-10-07	APELLATION	-	PAGE OF
			STANDA-RDIZATION		DATE				
			TO SIGN	陈国提	DATE				
			AUDITING		DATE				
MARKER	MODIFY	FILE NO	SIGNATURE	DATE	APPROV	DATE			

16

CUSTOMER	HONGKONG CO.	CUSTOMER APPROVAL	CUST PART NO.	X85381
			SECTION NO.	LH0088219

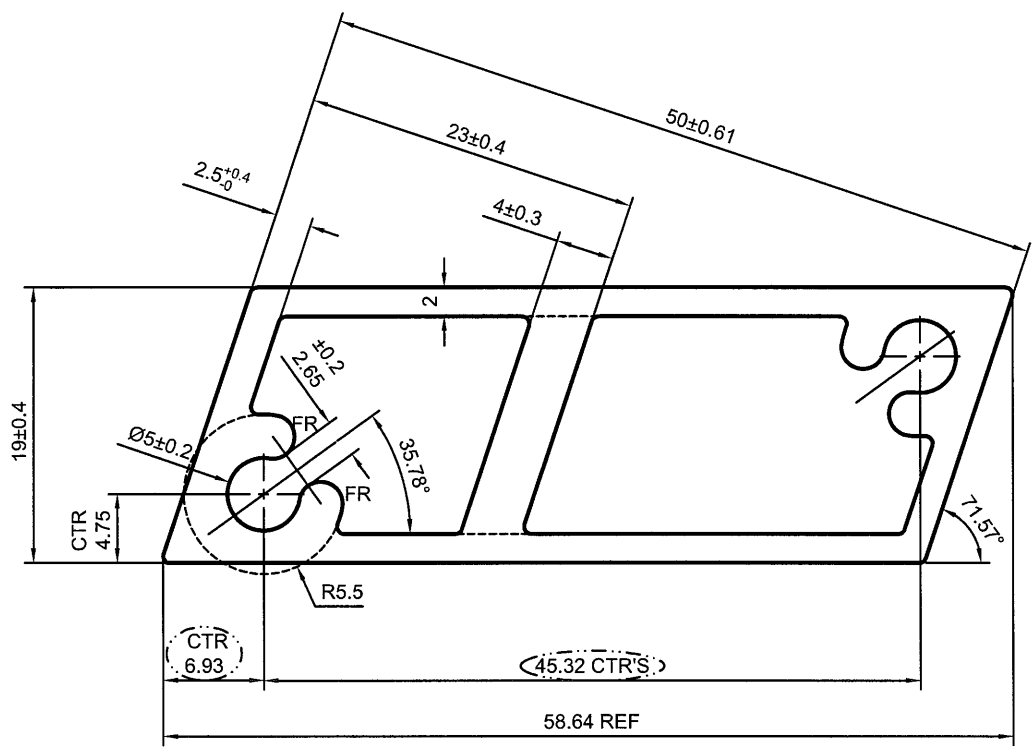

美特鋁質有限公司	
承認圖面	<i>[Signature]</i>
日期	19/10/16

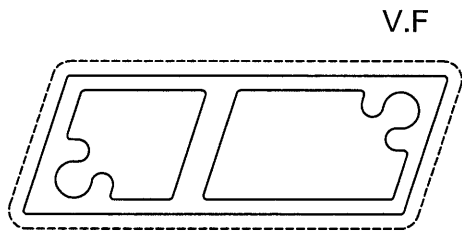

*配合尺寸以实物配合效果为准!

SIGNATURE GRADEING	HIGH SIGNATURE GRADEING	C.C.DIA(MM)	Ø 61.38						
AREA (SQ MM)	399.45 (416.26)	UNSPECIFIED THICKNESS	2+0.4/-0	PERIMETER (MM)	144.33	STANDARD	GB 5237.1	SCALE	2:1
MASS (KG/M)	1.128	UNSPECIFIED CORNERS	R 0.5	SURFACE AREA	144.33	ALLOY	6063-T6	VERSION	A
COMPANY ISSUE		A	DRAWA	蔡晓巡	DATE	2016-10-07	APELLATION	-	PAGE OF
			STANDARDIZATION		DATE				
			TO SIGN	陈国提	DATE				
			AUDITING		DATE				
MARKER	MODIFY	FILE NO	SIGNATURE	DATE	APPROV	DATE			

17

CUSTOMER	HONGKONG CO.	CUSTOMER APPROVAL	CUST PART NO.	X85382
			SECTION NO.	LH0088220

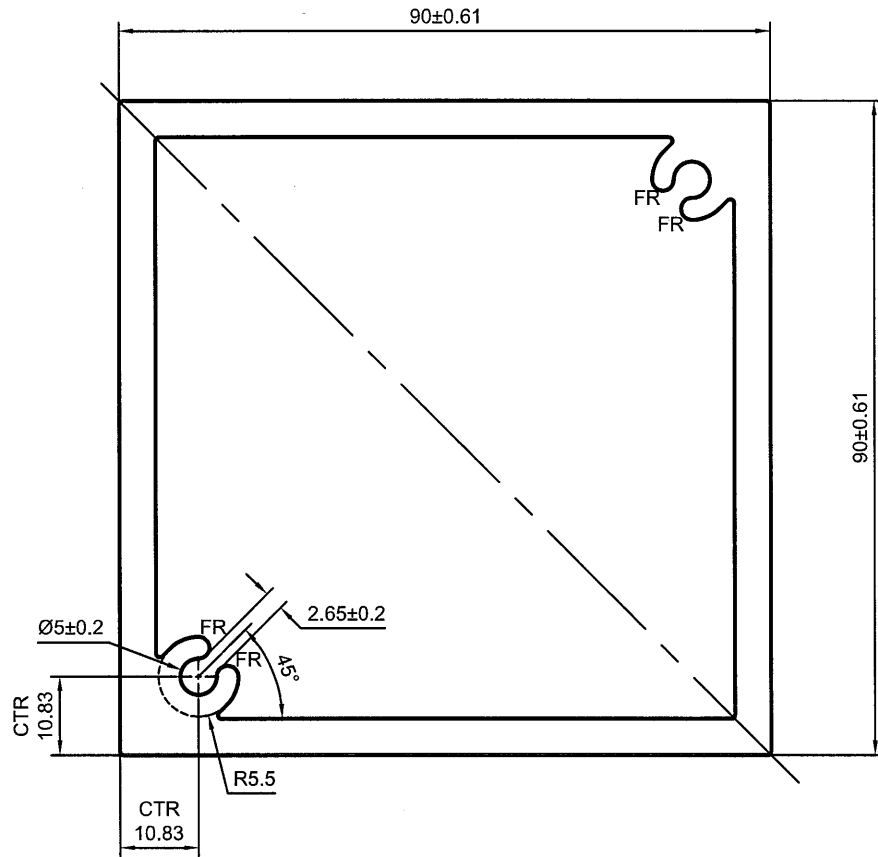

美特鋁質有限公司	
承認圖面	<i>[Signature]</i>
日期	19/10/16

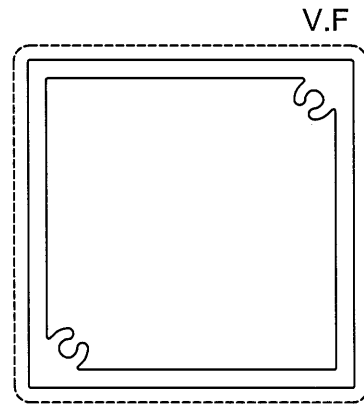

*配合尺寸以实物配合效果为准!

SCALE 1:2

SIGNATURE GRADEING	HIGH SIGNATURE GRADEING	C.C.DIA(MM)	Ø 126.87						
AREA (SQ MM)	1854.24 (1911.86)	UNSPECIFIED THICKNESS	5 ^{+0.4} ₋₀	PERIMETER (MM)	359.14	STANDARD	GB 5237.1	SCALE	1:1
MASS (KG/M)	5.181	UNSPECIFIED CORNERS	R 0.5	SURFACE AREA	359.14	ALLOY	6063-T6	VERSION	A
COMPANY ISSUE		A	DRAWA	蔡晓巡	DATE	2016-10-07	APELLATION	-	PAGE OF
			STANDA-RDIZATION		DATE				
			TO SIGN	陈国提	DATE				
			AUDITING		DATE				
MARKER	MODIFY FILE NO	SIGNATURE	DATE	APPROV		DATE			



CUSTOMER	HONGKONG CO.	CUSTOMER APPROVAL	CUST PART NO.	X85383
			SECTION NO.	LH0088221

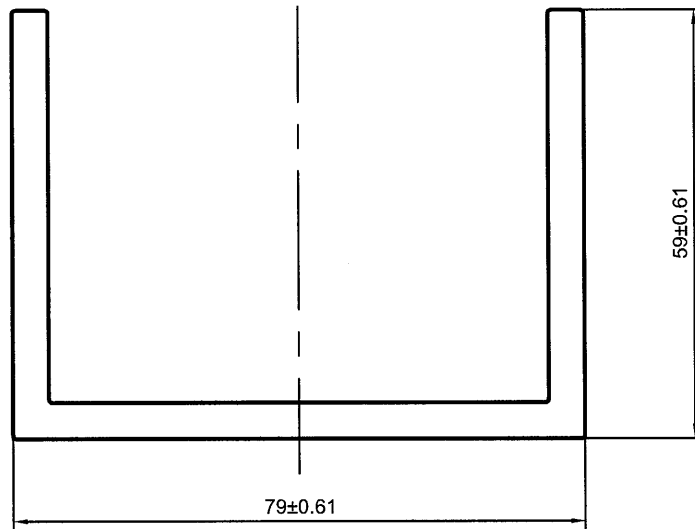

美特鋁質有限公司	
承認圖面	<i>[Signature]</i>
日期	19/10/16

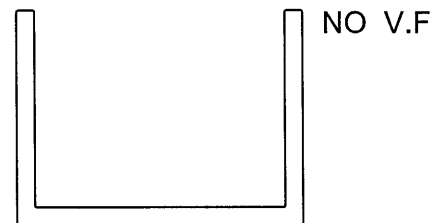

*配合尺寸以实物配合效果为准!

SCALE 1:2

SIGNATURE GRADEING	HIGH SIGNATURE GRADEING	C.C.DIA(MM)	Ø 98.2		SCALE 1:2				
AREA (SQ MM)	934.79 (970.06)	UNSPECIFIED THICKNESS	$5^{+0.4}_{-0}$	PERIMETER (MM)	382.28	STANDARD	GB 5237.1	SCALE	1:1
MASS (KG/M)	2.629	UNSPECIFIED CORNERS	R 0.5	SURFACE AREA		ALLOY	6061-T6	VERSION	A
COMPANY ISSUE		A	DRAWA	蔡晓巡	DATE	2016-10-07	APPELLATION	-	PAGE OF
			STANDA-RDIZATION		DATE				
			TO SIGN	陈国提	DATE				
			AUDITING		DATE				
MARKER	MODIFY FILE NO	SIGNATURE	DATE	APPROV		DATE			



19

CUSTOMER	HONGKONG CO.	CUSTOMER APPROVAL	CUST PART NO.	X85385
			SECTION NO.	LH0088222

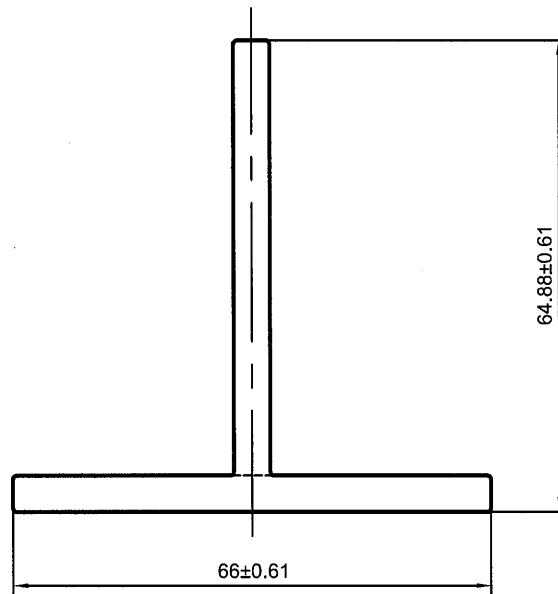

美特鋁質有限公司	
承認圖面	<i>[Signature]</i>
日期	19/10/16

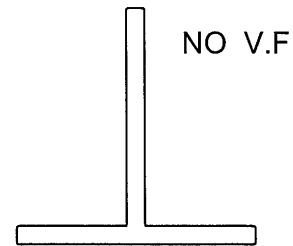

*配合尺寸以实物配合效果为准!

SCALE 1:2

SIGNATURE GRADEING	HIGH SIGNATURE GRADEING	C.C.DIA(MM)	Ø 81.45						
AREA (SQ MM)	629.19 (653.32)	UNSPECIFIED THICKNESS	5 ^{+0.4} ₋₀	PERIMETER (MM)	260.04	STANDARD	GB 5237.1	SCALE	1:1
MASS (KG/M)	1.771	UNSPECIFIED CORNERS	R 0.5	SURFACE AREA		ALLOY	6061-T6	VERSION	A
COMPANY ISSUE		A	DRAWA	蔡晓巡	DATE	2016-10-07	APELLATION	-	PAGE OF
			STANDA-RDIZATION		DATE				
			TO SIGN	陈国提	DATE				
			AUDITING		DATE				
MARKER	MODIFY	FILE NO	SIGNATURE	DATE	APPROV				



PANASIA ALUMINUM (CHINA) LIMITED

CUSTOMER	HONGKONG CO.	CUSTOMER APPROVAL	CUST PART NO.	X85386
			SECTION NO.	LH0088223

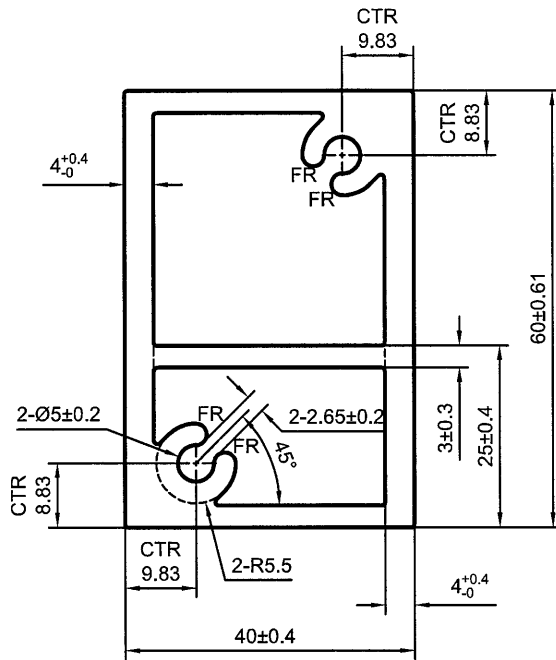

美特鋁質有限公司	
承認圖面	<i>[Signature]</i>
日期	19/10/16

V.F

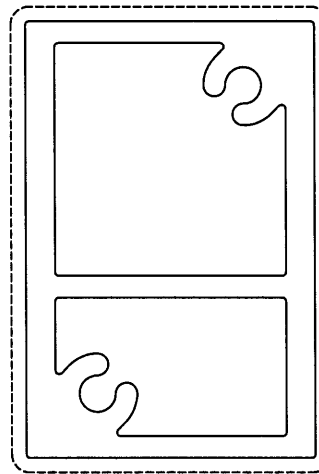

*配合尺寸以实物配合效果为准!

SCALE 1:1

SIGNATURE GRADEING	HIGH SIGNATURE GRADEING	C.C.DIA(MM)	Ø71.72						
AREA (SQ MM)	922.46 (949.28)	UNSPECIFIED THICKNESS	3 ^{+0.4} ₀	PERIMETER (MM)	199.14	STANDARD	GB 5237.1	SCALE	1:1
MASS (KG/M)	2.573	UNSPECIFIED CORNERS	R 0.5	SURFACE AREA	199.14	ALLOY	6063-T6	VERSION	A
COMPANY ISSUE		A	DRAWA	蔡晓巡	DATE	2016-10-07	APPELLATION	-	PAGE OF
			STANDARDIZATION		DATE				
			TO SIGN	陈国提	DATE				
			AUDITING		DATE				
MARKER	MODIFY	FILE NO	SIGNATURE	DATE	APPROV				



21

CUSTOMER	HONGKONG CO.	CUSTOMER APPROVAL	CUST PART NO.	X85387
			SECTION NO.	LH0088224

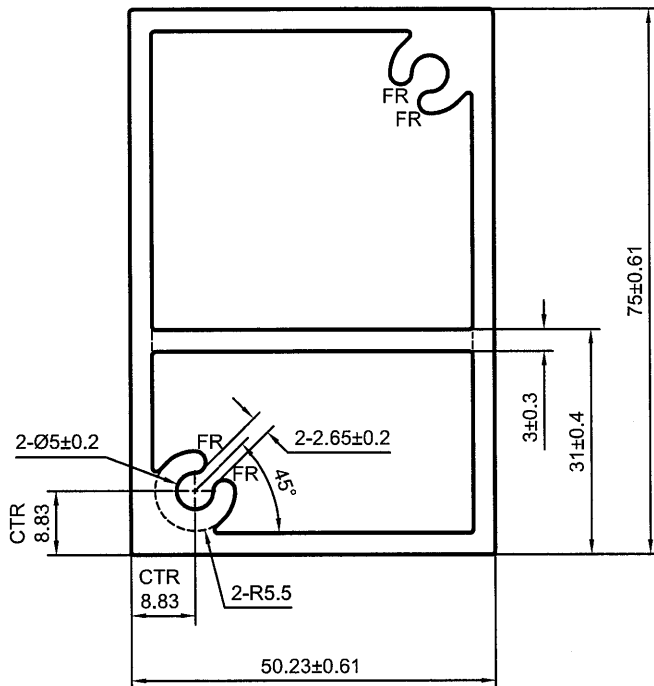

V.F

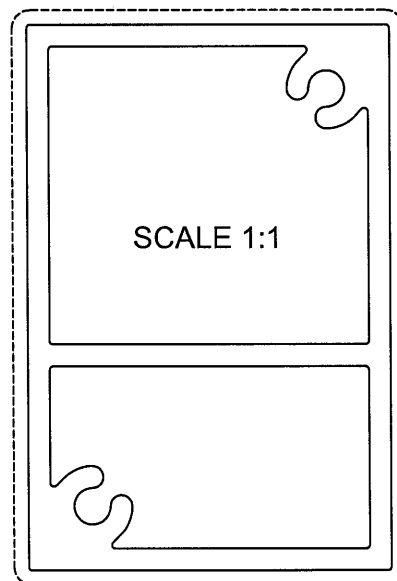

英特鋁質有限公司	
承認圖面	<i>[Signature]</i>
日期	19/10/16

*配合尺寸以实物配合效果为准!

SIGNATURE GRADEING	HIGH SIGNATURE GRADEING	C.C.DIA(MM)	Ø 89.88						
AREA (SQ MM)	1002.53 (1040.24)	UNSPECIFIED THICKNESS	3 ^{+0.4} ₋₀	PERIMETER (MM)	249.6	STANDARD	GB 5237.1	SCALE	1:1
MASS (KG/M)	2.819	UNSPECIFIED CORNERS	R 0.5	SURFACE AREA	249.6	ALLOY	6063-T6	VERSION	A
COMPANY ISSUE		A	DRAWA	蔡晓巡	DATE	2016-10-07	APELLATION	-	PAGE OF
			STANDARDIZATION		DATE				
			TO SIGN	陈国提	DATE				
			AUDITING		DATE				
MARKER	MODIFY	FILE NO	SIGNATURE	DATE	APPROV				



22

CUSTOMER	HONGKONG CO.	CUSTOMER APPROVAL	CUST PART NO.	X85388
			SECTION NO.	LH0088225

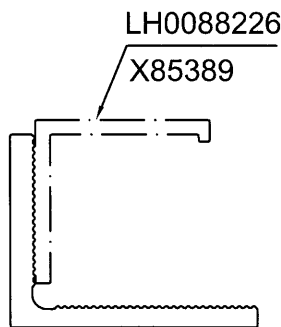
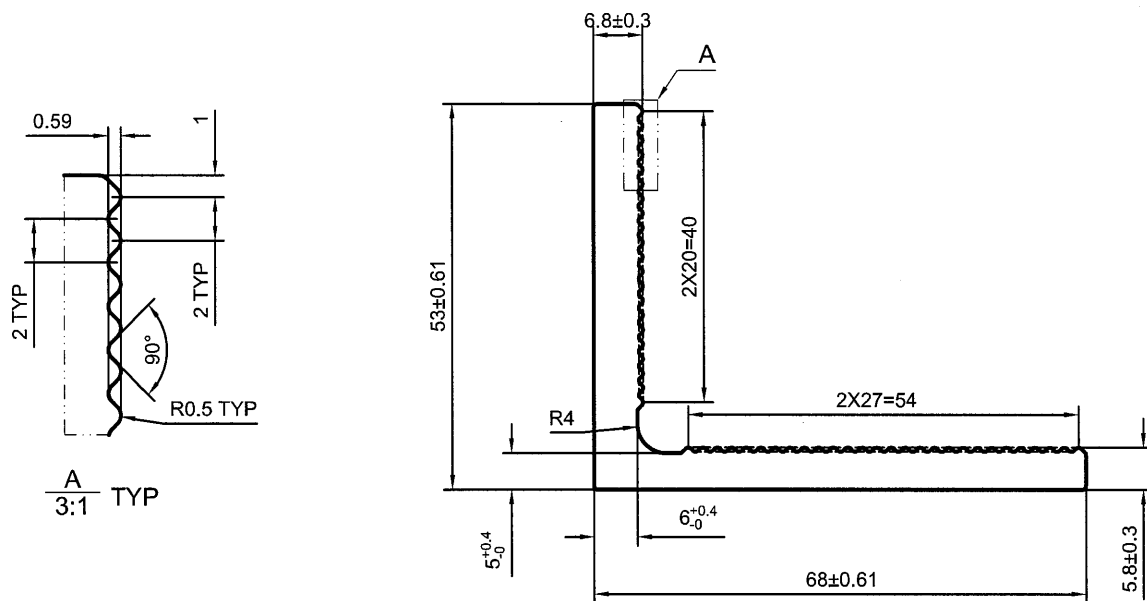

SCALE 1:2

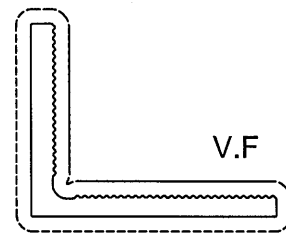

SCALE 1:2

*配合尺寸以实物配合效果为准!

英特鋁質有限公司	
承認圖面	<i>lnf</i>
日期	19/10/16

SIGNATURE GRADEING	HIGH SIGNATURE GRADEING	C.C.DIA(MM)	Ø 85.81						
AREA (SQ MM)	680.17 (682.57)	UNSPECIFIED THICKNESS	PERIMETER (MM)	259.54	STANDARD	GB 5237.1	SCALE	1:1	
MASS (KG/M)	1.85	UNSPECIFIED CORNERS	R 0.5	SURFACE AREA	259.54	ALLOY	6061-T6	VERSION	A
COMPANY ISSUE		A	DRAWA	蔡晓巡	DATE	2016-10-07	APELLATION	-	PAGE OF
			STANDA-RDIZATION		DATE				
			TO SIGN	陈国提	DATE				
			AUDITING		DATE				
MARKER	MODIFY	FILE NO	SIGNATURE	DATE	APPROV	DATE			

 PANASIA ALUMINUM (CHINA) LIMITED

23

CUSTOMER	HONGKONG CO.	CUSTOMER APPROVAL		CUST PART NO.	X85389
				SECTION NO.	LH0088226

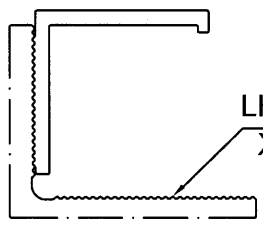
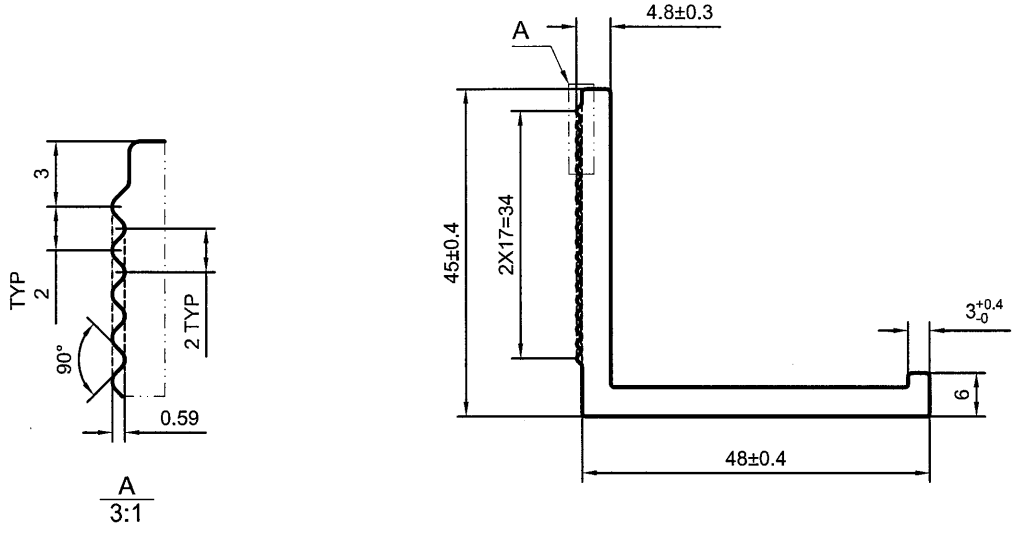

SCALE 1:2

LH0088225
X85388

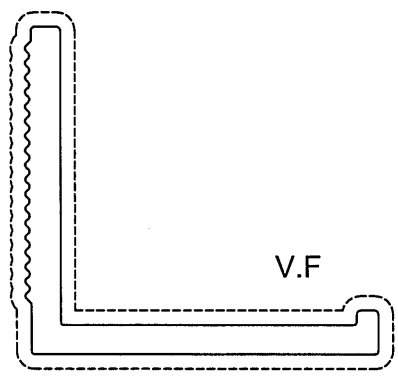
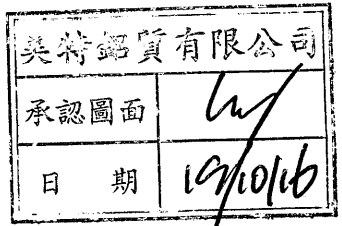

SCALE 1:1

*配合尺寸以实物配合效果为准!

SIGNATURE GRADEING	HIGH SIGNATURE GRADEING	C.C.DIA(MM)	Ø 65.38						
AREA (SQ MM)	379.74 (396.46)	UNSPECIFIED THICKNESS	4 ^{+0.4} ₋₀	PERIMETER (MM)	195.64	STANDARD	GB 5237.1	SCALE	1:1
MASS (KG/M)	1.074	UNSPECIFIED CORNERS	R 0.5	SURFACE AREA	195.64	ALLOY	6063-T6	VERSION	A
COMPANY ISSUE		A	DRAWN	蔡晓巡	DATE	2016-10-07	APPELLATION	-	PAGE OF
			STANDARDIZATION		DATE				
			TO SIGN	陈国提	DATE				
			AUDITING		DATE				
MARKER	MODIFY	FILE NO	SIGNATURE	DATE	APPROV				

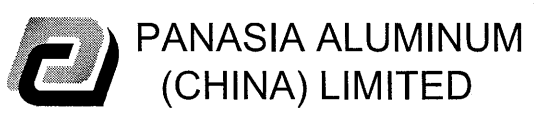

24

CUSTOMER	HONGKONG CO.	CUSTOMER APPROVAL	CUST PART NO.	X85392
			SECTION NO.	LH0088227

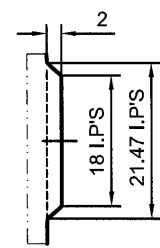
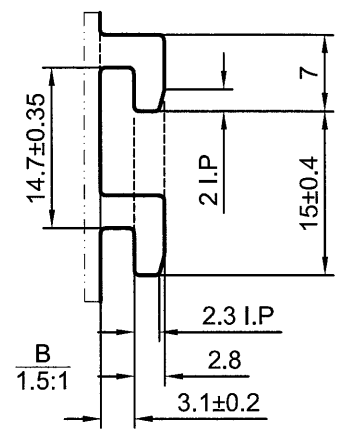
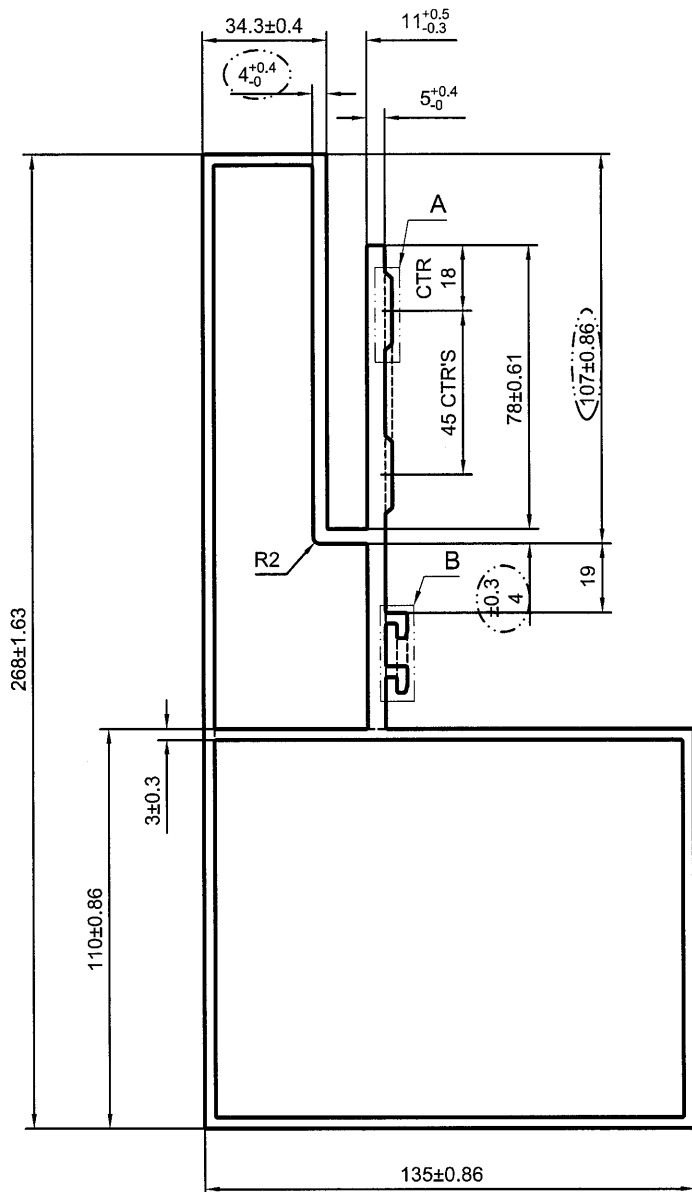

A
2:1 TYP(2)

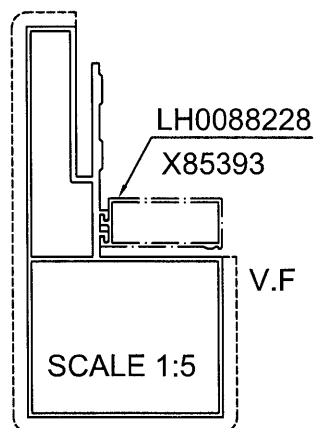

美特鋁質有限公司
承認圖面
日期 19/10/16

*配合尺寸以实物配合效果为准！

SIGNATURE GRADEING	HIGH SIGNATURE GRADEING	C.C.DIA(MM)	Ø 299.74						
AREA (SQ MM)	3262.92 (3413.22)	UNSPECIFIED THICKNESS	3+0.4/-0	PERIMETER (MM)	1000.22	STANDARD	GB 5237.1	SCALE	1:2
MASS (KG/M)	9.25	UNSPECIFIED CORNERS	R 0.5	SURFACE AREA	547.23	ALLOY	6063-T6	VERSION	A
COMPANY ISSUE		A	DRAWA	蔡晓巡	DATE	2016-10-07	APPELLATION	-	PAGE OF
			STANDAR- RDIZATION		DATE				
			TO SIGN	陈国提	DATE				
			AUDITING		DATE				
MARKER	MODIFY	FILE NO	SIGNATURE	DATE	APPROV	DATE			



25

CUSTOMER	HONGKONG CO.	CUSTOMER APPROVAL		CUST PART NO.	X85393
				SECTION NO.	LH0088228

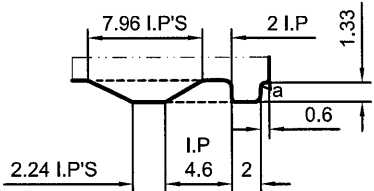
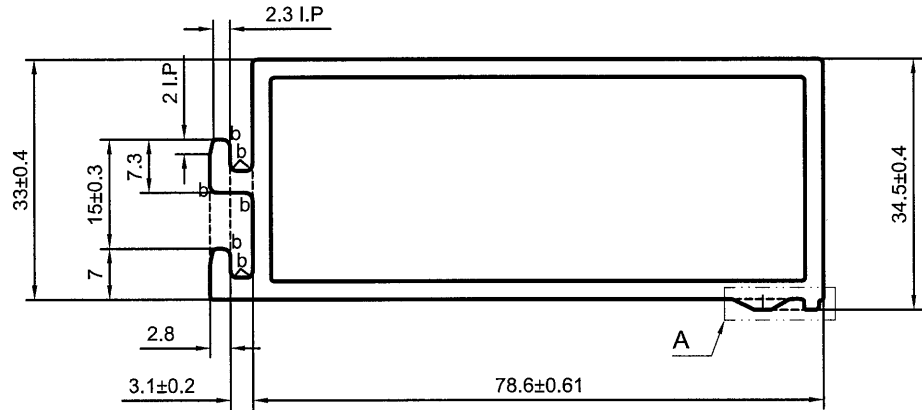

A
2:1

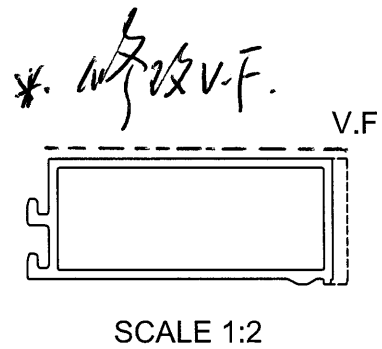
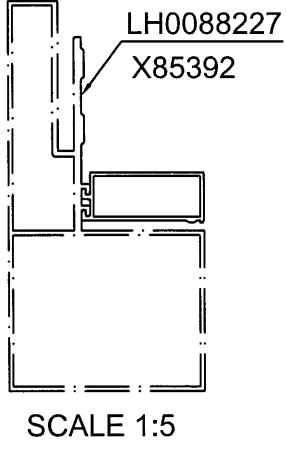

a=R0.3
b=R1.0

英特鋁質有限公司	
承認圖面	<i>[Signature]</i>
日期	19/10/16

*配合尺寸以实物配合效果为准!

SIGNATURE GRADEING	HIGH SIGNATURE GRADEING	C.C.DIA(MM)	Ø 90.42						
AREA (SQ MM)	601.78 (642.25)	UNSPECIFIED THICKNESS	2.5 ^{+0.4} ₋₀	PERIMETER (MM)	261.11	STANDARD	GB 5237.1	SCALE	1:1
MASS (KG/M)	1.741	UNSPECIFIED CORNERS	R 0.5	SURFACE AREA	35.41	ALLOY	6063-T6	VERSION	A
COMPANY ISSUE		A	DRAWA	蔡晓巡	DATE	2016-10-07	APELLATION	-	PAGE OF
			STANDA-RDIZATION		DATE				
			TO SIGN	陈国提	DATE				
			AUDITING		DATE				
MARKER	MODIFY	FILE NO	SIGNATURE	DATE	APPROV				

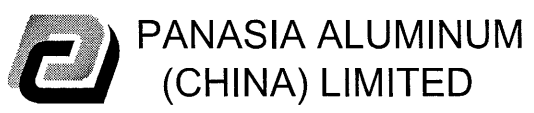

26

CUSTOMER	HONGKONG CO.	CUSTOMER APPROVAL	CUST PART NO.	X85394
			SECTION NO.	LH0088229

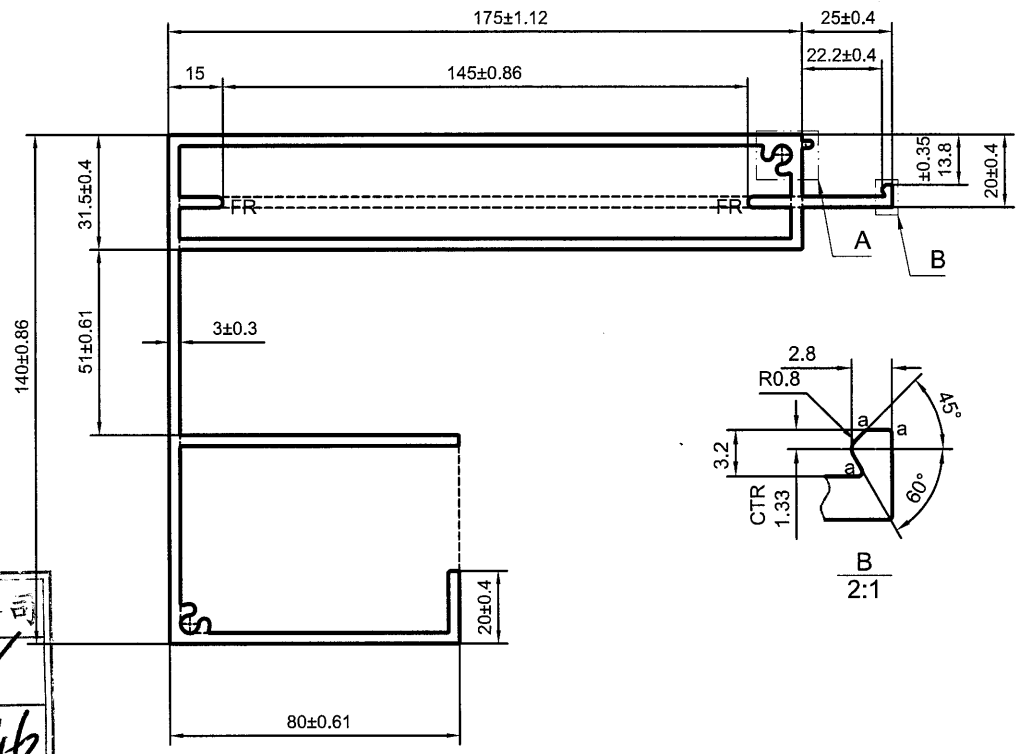

美特鋁質有限公司
承認圖面
日期 19/10/16

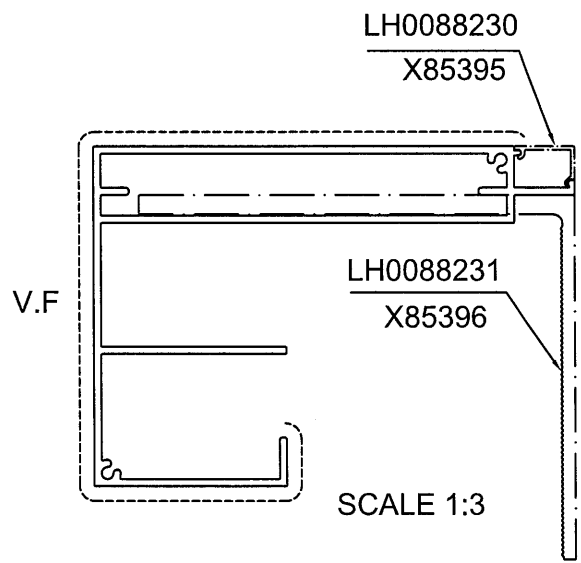
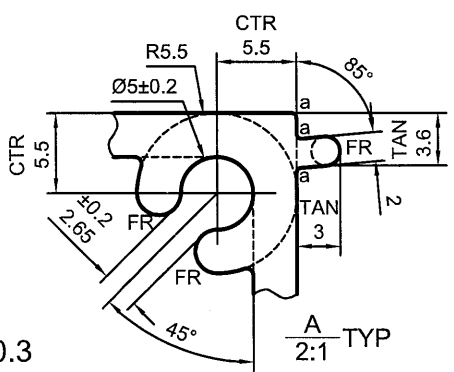
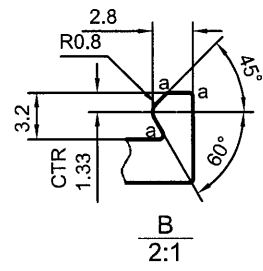

*配合尺寸以实物配合效果为准!

SIGNATURE GRADEING	HIGH SIGNATURE GRADEING	C.C.DIA(MM)	Ø 236.74						
AREA (SQ MM)	2250.91 (2385.95)	UNSPECIFIED THICKNESS	3 ^{+0.4} ₋₀	PERIMETER (MM)	1040.61	STANDARD	GB 5237.1	SCALE	1:2
MASS (KG/M)	6.466	UNSPECIFIED CORNERS	R 0.5	SURFACE AREA	414.81	ALLOY	6063-T6	VERSION	A
COMPANY ISSUE		A	DRAWA	蔡晓巡	DATE	2016-10-07	APELLATION	-	PAGE OF
			STANDA-RDIZATION		DATE				
			TO SIGN	陈国提	DATE				
			AUDITING		DATE				
MARKER	MODIFY	FILE NO	SIGNATURE	DATE	APPROV	DATE			

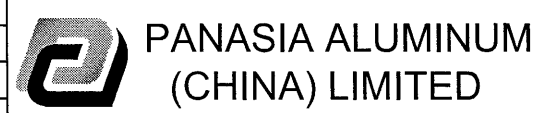

CUSTOMER	HONGKONG CO.	CUSTOMER APPROVAL	CUST PART NO.	X85395
			SECTION NO.	LH0088230

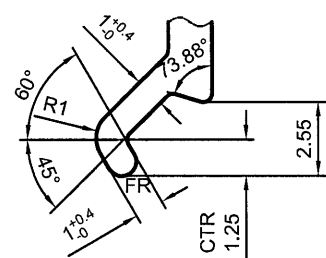
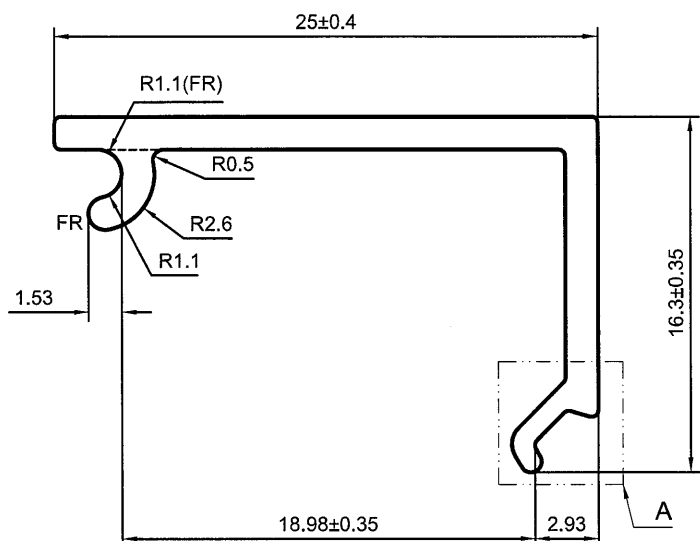

A
4:1

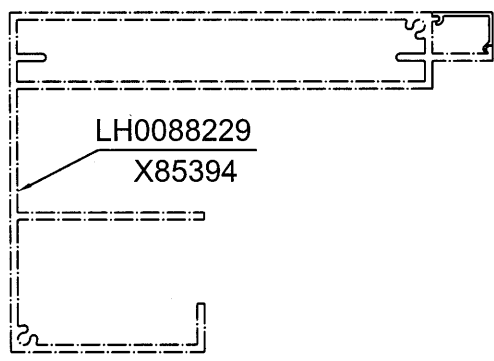

SCALE 1:3

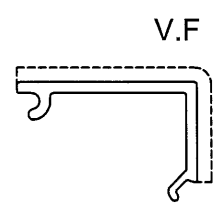

SCALE 1:1

美特鋁質有限公司	
承認圖面	<i>[Signature]</i>
日期	19/10/16

*配合尺寸以实物配合效果为准!

SIGNATURE GRADEING	HIGH SIGNATURE GRADEING	C.C.DIA(MM)	Ø 28.32						
AREA (SQ MM)	66.63 (73.97)	UNSPECIFIED THICKNESS	1.5 ^{+0.4} ₋₀	PERIMETER (MM)	92.14	STANDARD	GB 5237.1	SCALE	3:1
MASS (KG/M)	0.2	UNSPECIFIED CORNERS	R 0.3	SURFACE AREA	39.05	ALLOY	6063-T5	VERSION	A
COMPANY ISSUE		A	DRAWA	蔡晓巡	DATE	2016-10-07	APELLATION	-	PAGE OF
			STANDA-RDIZATION		DATE				
			TO SIGN	陈国提	DATE				
			AUDITING		DATE				
MARKER	MODIFY	FILE NO	SIGNATURE	DATE	APPROV		DATE		

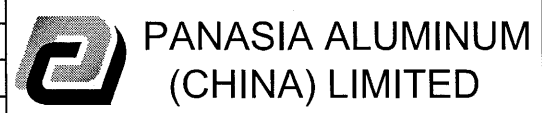

28

CUSTOMER	HONGKONG CO.	CUSTOMER APPROVAL	CUST PART NO.	X85396
			SECTION NO.	LH0088231

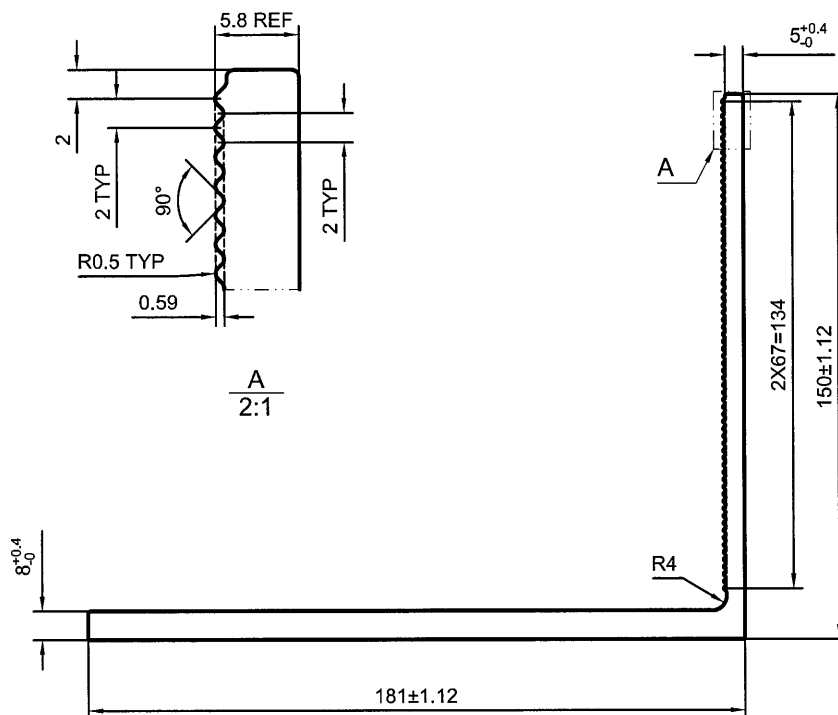

美特鋁質有限公司	
承認圖面	<i>[Signature]</i>
日期	19/10/16

LH0088229
X85394

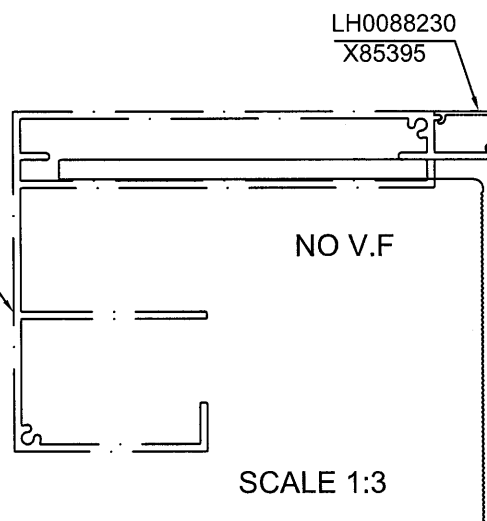

*配合尺寸以实物配合效果为准!

SIGNATURE GRADEING	HIGH SIGNATURE GRADEING	C.C.DIA(MM)	Ø 234.67						
AREA (SQ MM)	2229.12 (2292.68)	UNSPECIFIED THICKNESS	PERIMETER (MM)	686.53	STANDARD	GB 5237.1	SCALE	1:2	
MASS (KG/M)	6.213	UNSPECIFIED CORNERS	R 0.5	SURFACE AREA	ALLOY	6061-T6	VERSION	A	
COMPANY ISSUE		A	DRAWA	蔡晓巡	DATE	2016-10-07	APELLATION	-	PAGE OF
			STANDA-RDIZATION		DATE				
			TO SIGN	陈国提	DATE				
			AUDITING		DATE				
MARKER	MODIFY	FILE NO	SIGNATURE	DATE	APPROV				

 PANASIA ALUMINUM (CHINA) LIMITED

29

CUSTOMER	HONGKONG CO.	CUSTOMER APPROVAL		CUST PART NO.	X85397
				SECTION NO.	LH0088232

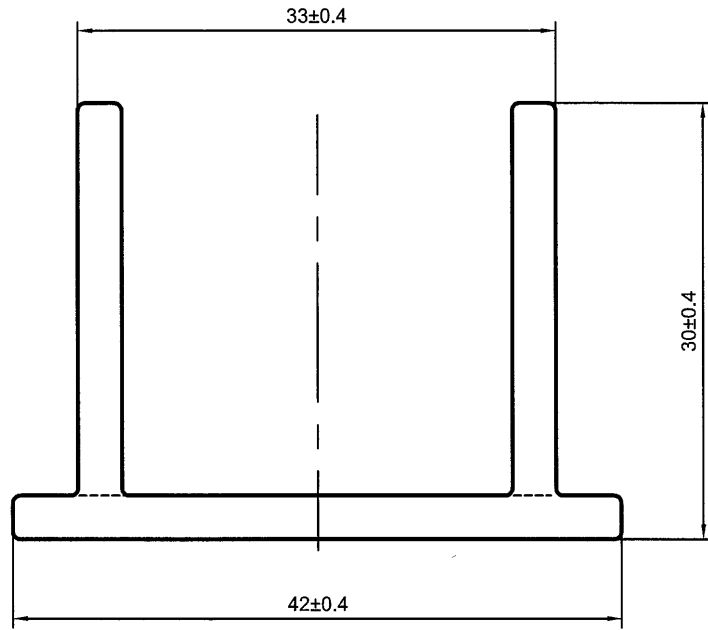

美特鋁質有限公司	
承認圖面	<i>[Signature]</i>
日期	19/10/16

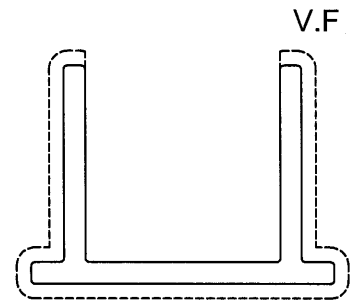

*配合尺寸以实物配合效果为准！

SCALE 1:1

SIGNATURE GRADEING	HIGH SIGNATURE GRADEING	C.C.DIA(MM)	Ø 48.18						
AREA (SQ MM)	287.79 (305.71)	UNSPECIFIED THICKNESS	3 ^{+0.4} ₋₀	PERIMETER (MM)	195.42	STANDARD	GB 5237.1	SCALE	2:1
MASS (KG/M)	0.828	UNSPECIFIED CORNERS	R 0.5	SURFACE AREA	115.85	ALLOY	6063-T6	VERSION	A
COMPANY ISSUE		A	DRAWA	蔡晓巡	DATE	2016-10-07	APELLATION	-	PAGE OF
			STANDA-RDIZATION		DATE				
			TO SIGN	陈国提	DATE				
			AUDITING		DATE				
MARKER	MODIFY	FILE NO	SIGNATURE	DATE	APPROV		DATE		